



Chipsmall Limited consists of a professional team with an average of over 10 year of expertise in the distribution of electronic components. Based in Hongkong, we have already established firm and mutual-benefit business relationships with customers from,Europe,America and south Asia,supplying obsolete and hard-to-find components to meet their specific needs.

With the principle of “Quality Parts,Customers Priority,Honest Operation,and Considerate Service”,our business mainly focus on the distribution of electronic components. Line cards we deal with include Microchip,ALPS,ROHM,Xilinx,Pulse,ON,Everlight and Freescale. Main products comprise IC,Modules,Potentiometer,IC Socket,Relay,Connector.Our parts cover such applications as commercial,industrial, and automotives areas.

We are looking forward to setting up business relationship with you and hope to provide you with the best service and solution. Let us make a better world for our industry!



Contact us

Tel: +86-755-8981 8866 Fax: +86-755-8427 6832

Email & Skype: info@chipsmall.com Web: www.chipsmall.com

Address: A1208, Overseas Decoration Building, #122 Zhenhua RD., Futian, Shenzhen, China





LED Display Product Data Sheet LSHD-7803

Spec No.: DS30-2002-149

Effective Date: 09/01/2010

Revision: A

LITE-ON DCC

RELEASE

BNS-OD-FC001/A4

FEATURES

- * 0.3 inch (7.62 mm) DIGIT HEIGHT
- * EXCELLENT SEGMENT UNIFORMITY
- * LOW POWER REQUIREMENT
- * HIGH BRIGHTNESS AND HIGH CONTRAST
- * WIDE VIEWING ANGLE
- * SOLID STATE RELIABILITY
- * BINNED FOR LUMINOUS INTENSITY

DESCRIPTION

The LSHD-7803 is a 0.3 inch (7.62 mm) digit height single-digit display. This device uses GREEN LED chips (GaP epi on GaP substrate). The display has gray face and green segments.

DEVICE

PART NO.	DESCRIPTION
GREEN	Common Cathode
LSHD-7803	Rt. Hand Decimal

PACKAGE DIMENSIONS

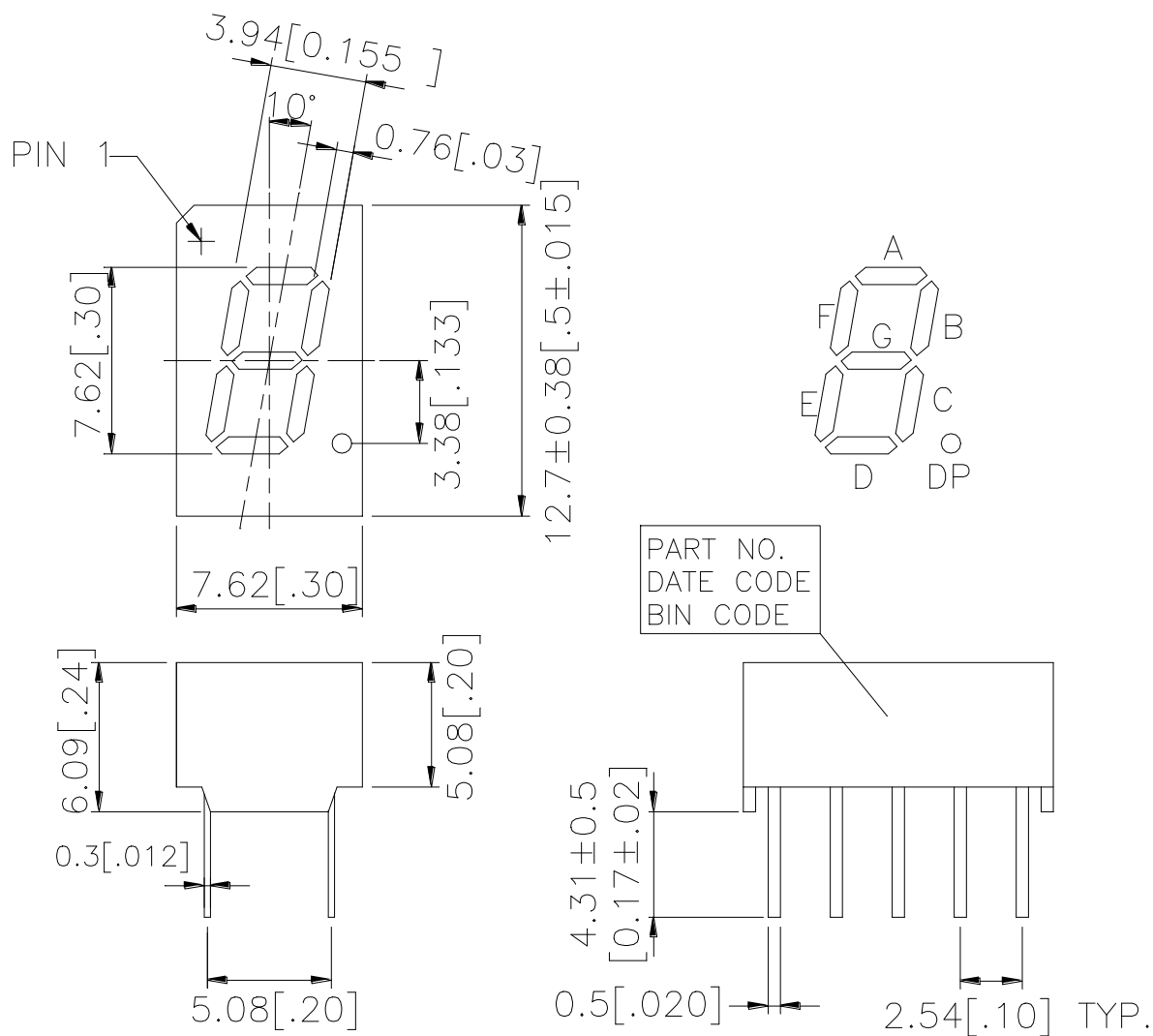

NOTES: All dimensions are in millimeters. Tolerances are ± 0.25mm (0.01") unless otherwise noted.

INTERNAL CIRCUIT DIAGRAM

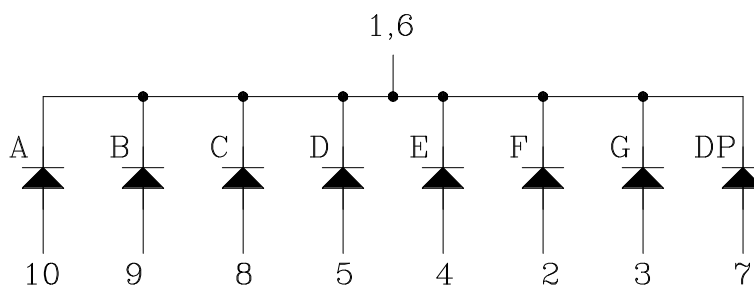

PIN CONNECTION

No.	CONNECTION
1	Common Cathode
2	Anode F
3	Anode G
4	Anode E
5	Anode D
6	Common Cathode
7	Anode DP
8	Anode C
9	Anode B
10	Anode A

ABSOLUTE MAXIMUM RATING AT Ta = 25°C

PARAMETER	MAXIMUM RATING	UNIT
Power Dissipation Per Segment	75	mW
Peak Forward Current Per Segment (Frequency 1Khz, 10% duty cycle)	100*	mA
Continuous Forward Current Per Segment	25	mA
Forward Current Derating from 25°C	0.28	mA/°C
Reverse Voltage Per Segment	5	V
Operating Temperature Range	-35°C to +105°C	
Storage Temperature Range	-35°C to +105°C	
Soldering Conditions : 1/16 inch below seating plane for 3 seconds at 260°C		

* see figure 5 to establish pulsed condition

ELECTRICAL / OPTICAL CHARACTERISTICS AT Ta = 25°C

PARAMETER	SYMBOL	MIN	TYP	MAX	UNIT	TEST CONDITION
Average Luminous Intensity Per Segment	I _v	500	1600		μcd	I _F = 10mA
Peak Emission Wavelength	λ _p		565		nm	I _F = 20mA
Spectral Line Half-Width	Δλ		30		nm	I _F = 20mA
Dominant Wavelength	λ _d		569		nm	I _F = 20mA
Forward Voltage Per Segment	V _F		2.1	2.6	V	I _F = 20mA
Reverse Current Per Segment	I _R			100	μA	V _R = 5V
Luminous Intensity Matching Ratio	I _v -m			2 : 1		I _F = 10mA

Note: Luminous Intensity is measured with a light sensor and filter combination that approximates the CIE (Commision Internationale De L'Eclairage) eye-response curve.

TYPICAL ELECTRICAL / OPTICAL CHARACTERISTIC CURVES

(25°C Ambient Temperature Unless Otherwise Noted)

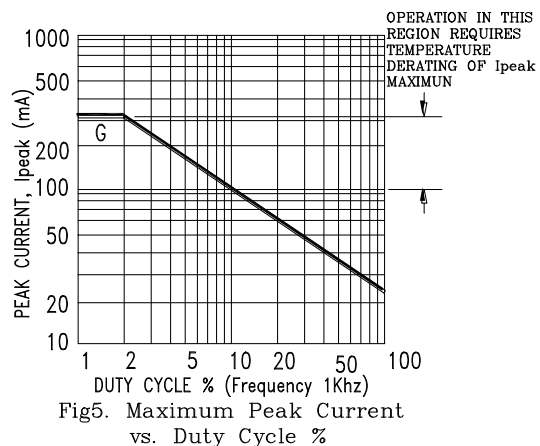
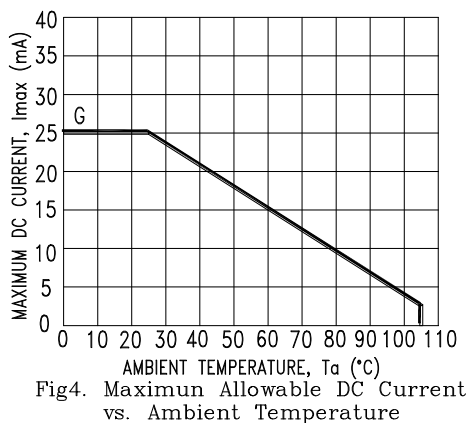
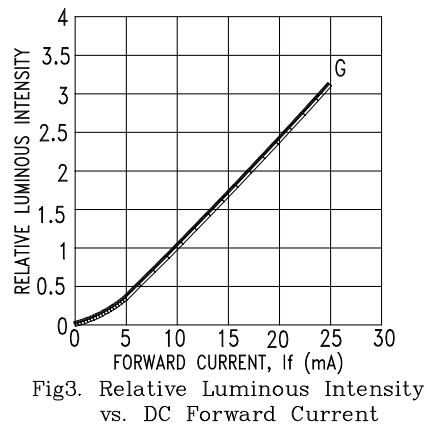
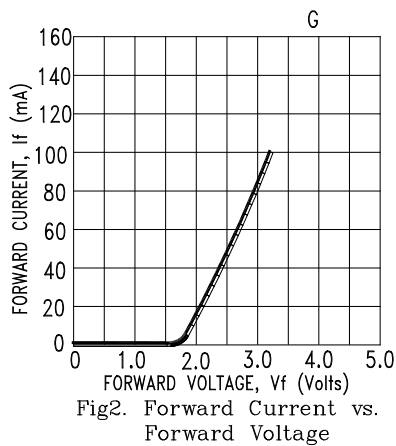
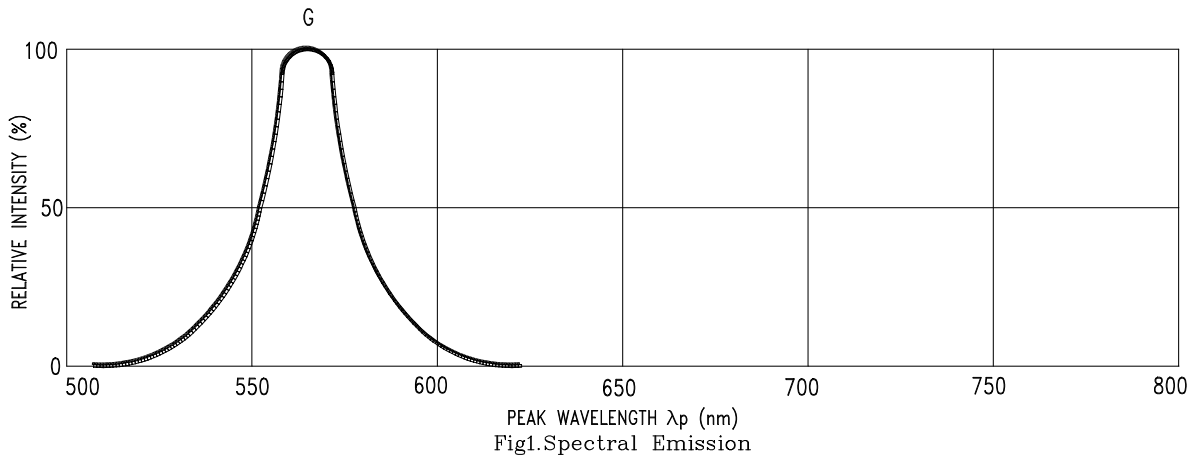

NOTE: G=GREEN.