



Chipsmall Limited consists of a professional team with an average of over 10 year of expertise in the distribution of electronic components. Based in Hongkong, we have already established firm and mutual-benefit business relationships with customers from,Europe,America and south Asia,supplying obsolete and hard-to-find components to meet their specific needs.

With the principle of “Quality Parts,Customers Priority,Honest Operation,and Considerate Service”,our business mainly focus on the distribution of electronic components. Line cards we deal with include Microchip,ALPS,ROHM,Xilinx,Pulse,ON,Everlight and Freescale. Main products comprise IC,Modules,Potentiometer,IC Socket,Relay,Connector.Our parts cover such applications as commercial,industrial, and automotives areas.

We are looking forward to setting up business relationship with you and hope to provide you with the best service and solution. Let us make a better world for our industry!



Contact us

Tel: +86-755-8981 8866 Fax: +86-755-8427 6832

Email & Skype: info@chipsmall.com Web: www.chipsmall.com

Address: A1208, Overseas Decoration Building, #122 Zhenhua RD., Futian, Shenzhen, China



LSP05 Module Series



Agency Approvals

Agency	Standard	Agency File Number
	UL1449	E320116

Applications

- Outdoor and Commercial LED Lighting
- Roadway lighting
- Traffic lighting
- Digital signage
- Wash wall lighting
- Parking garage/lot lighting
- Flood lighting
- Tunnel lighting
- Street lighting

Additional Information



Datasheet



Resources



Samples

Description

The Littelfuse LSP05 thermally protected Surge Protective Device is a self-protected device which is specially designed to be used in outdoor and commercial LED lighting fixtures for transient overvoltage protection. It is constructed with Littelfuse thermally protected varistor technology. Its built-in thermal disconnect function provides additional protection to prevent catastrophic failure and fire hazard even under the extreme circumstances of varistor end-of-life or sustaining over voltage conditions. The LSP05 facilitates customer's product compliance to IEEE C62.41.2 Location Category C Low and US Dept of Energy MSSLC Model Spec.

Features

- Maximum Discharge Current, 10kA, 8/20us
- Meets ANSI C82.77-5-2015: Location Category CM, 10kV/5kA, 1.2/50μS-8/20μS Combination Wave.
- Meets IEEE C62.41.2: Location Category C Low, 6kV/3kA, 1.2/50μS-8/20μS Combination Wave.
- Meets US Dept. of Energy MSSLC Model Spec.
- Parallel connected SPD device
- Thermally protected Varistor technology
- IP66 Water-proof and Dust-proof
- Indication wire lead options for Parallel connected modules
- UL 1449 Type 4 Component Assembly Recognition (Type 4CA)
- IEC61643-11 Class II/EN61643-11 Type 2 Compliant¹
- Compact form factor (48x48x30mm) with mounting tabs
- 240Vac and 277Vac voltage ratings are available for Class I and Class II installation based on IEC luminaire protection classes
- CE - Meets the requirements of Low Voltage and RoHS European Directives.

Notes:

1. Self-declared compliance.

Absolute Maximum Ratings

• For ratings of individual members of a series, see Device Ratings and Specifications chart

	LSP05 Series	Units
Continuous:		
Steady State Applied Voltage:		
Max AC Voltage Range ($V_{M(AC)(RMS)}$)	150 to 510	V
Transient:		
Maximum Discharge Current 8/20μs Waveform (I_{max})	10,000	A
Nominal Discharge Current 8/20μs Waveform (I_n)	5,000	A
Operating Ambient Temperature Range (T_A)	-45 to +85	°C
Storage Temperature Range (T_{STG})	-45 to +125	°C
Isolation Voltage Capability (When the thermal disconnect opens)	600	V
Insulation Resistance	>1,000	MΩ

CAUTION: Stresses above those listed in "Absolute Maximum Ratings" may cause permanent damage to the device. This is a stress only rating and operation of the device at these or any other conditions above those indicated in the operational sections of this specification is not implied.

LSP05 Series Device Ratings & Specifications

Part Number ⁷	Operating Voltage (VAC)	MCOV/Uc (VAC) ⁵	Maximum Discharge Current (Imax)(A) ²	Nominal Discharge Current (In)(A) ¹	MLV (V) ³	Up (V) ⁴	Safety Compliance	
							IEC/EN 61643-11 ⁶	UL1449
LSP05120*	120	150	10,000	5,000	L-N:680 L-G:680 N-G:630	800		X
LSP05240*	240	275	10,000	5,000	L-N:1100 L-G:1100 N-G:1100	1200	X	X
LSP05277*	277	320	10,000	5,000	L-N:1270 L-G:1270 N-G:1220	1400	X	X
LSP05347*	347	420	10,000	5,000	L-N:1600 L-G:1600 N-G:1580	1700		X
LSP05480*	480	510	10,000	5,000	L-N:1780 L-G:1780 N-G:1730	1900		X
LSP05240LL*	L-L:240	L-L:275	10,000	5,000	L-L:1100	L-L:1200		X
	L-N/G:120	L-N/G:150			L-N/G:680	L-N/G:800		X
LSP05480LL*	L-L:480	L-L:510	10,000	5,000	L-L:1780	L-L:1900		X
	L-N/G:277	L-N/G:320			L-N/G:1270	L-N/G:1400		X

Notes:

1. Nominal Discharge Current (In)(A): The nominal discharge current is a measure of the SPDs endurance capability; 15 impulses of discharge current uses the 8/20us current waveform.
2. Maximum Discharge Current (Imax)(A): The maximum discharge current is a measure of the SPDs maximum capability; single impulse of discharge current uses the 8/20us current waveform.
3. MLV – UL1449 Measured limiting voltage; the highest value of residual voltage measurements during the application of impulses of 8/20us nominal discharge current (In); an average voltage value of 15 impulses
4. Up – IEC 61643-11 Voltage protection level; the highest value of residual voltage measurements during the application of impulses of 8/20us nominal discharge current (In); a rounding voltage value of maximum measurement.
5. MCOV/UC: Maximum Continuous Operating Voltage - maximum r.m.s. voltage that could be continuously applied to the SPD.
6. Part Numbers LSP05xxxPM Only.
7. * = - P or PM
8. Repetitive Surge Withstanding: 15 strikes at 5,000A (8/20us) with steady MLV/Up.

Repetitive Surge Capability for LSP05

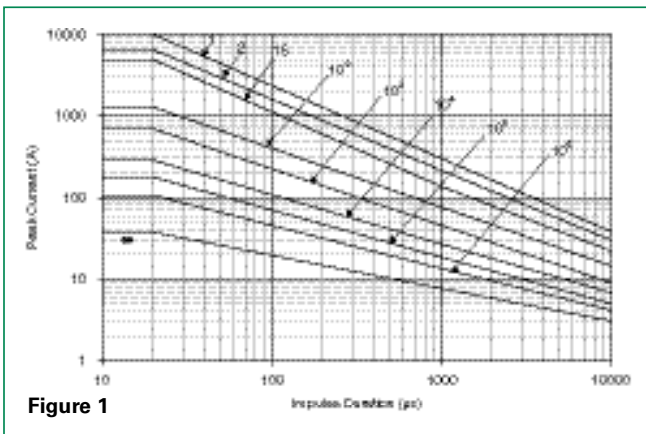
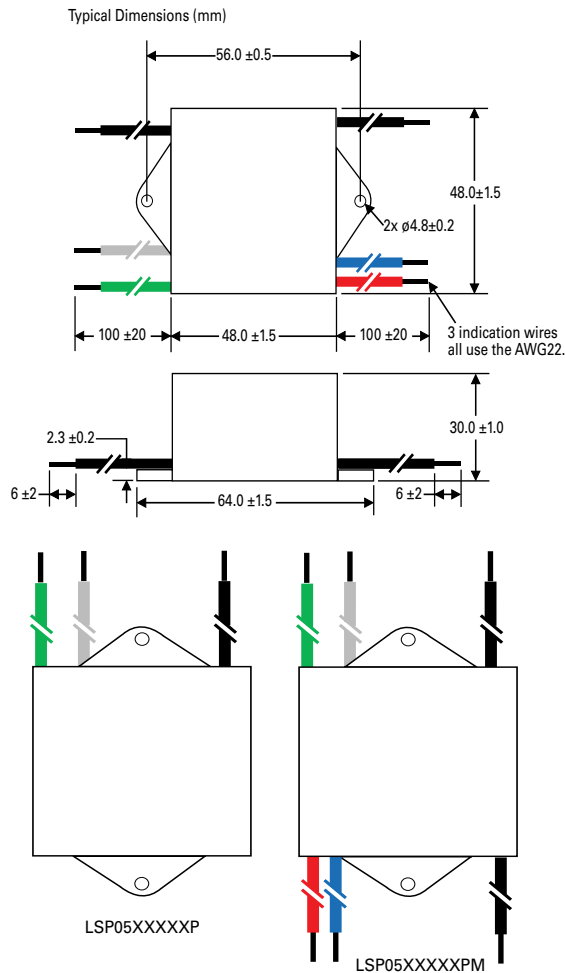

Figure 1

Pulse Rating (8x20µSec)	
Strikes	Surge
1	10,000A
2	7,000A
15	5,000A
100	1,500A
1,000	700A

Dimensions



Notes:

1. Black: Line; White: Neutral; Green: Ground
(P/N with suffix X3333/X3316: Brown: Line; Blue: Neutral; Green-Yellow stripe: Ground)
2. Black: R1; Red: R2; Blue: R3
3. Wire Gauge: AWG14 wire Line in, AWG22 Wire for indication; Wire Length: 100mm or customized

Part Numbering System

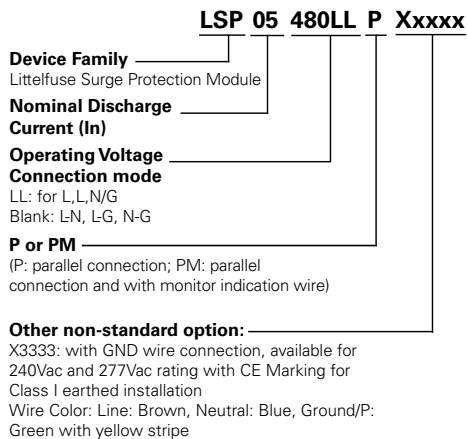

Application/Installation Schematic

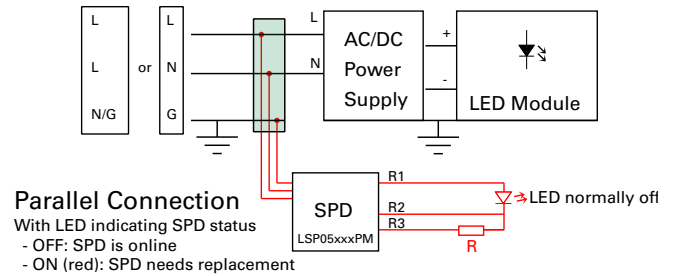
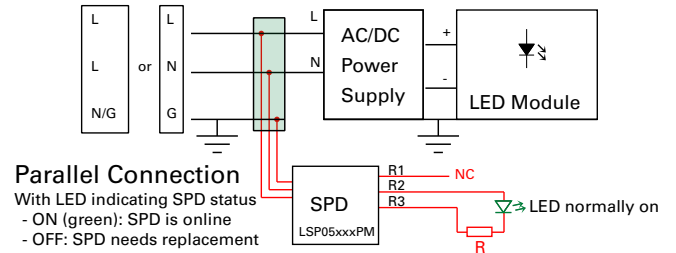

Notes:

1. LED indicator and associated circuitry are not included in the module.
2. R1 must be capped off by wire nut when not connected (NC).
3. R1 and R2 are AC line voltage (hot); R3 is AC neutral voltage.
4. R2 voltage is cut off when SPD needs replacement.
5. R is current limiting resistor; its resistance/wattage is determined by AC line voltage and desired current driving LED. Example: AC line voltage 240V, LED: 1.6mA, resistor: 150Kohm/0.5W.

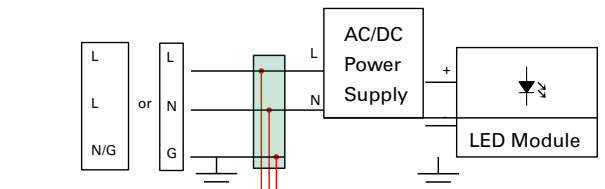

Parallel Connection

