



Chipsmall Limited consists of a professional team with an average of over 10 year of expertise in the distribution of electronic components. Based in Hongkong, we have already established firm and mutual-benefit business relationships with customers from,Europe,America and south Asia,supplying obsolete and hard-to-find components to meet their specific needs.

With the principle of “Quality Parts,Customers Priority,Honest Operation,and Considerate Service”,our business mainly focus on the distribution of electronic components. Line cards we deal with include Microchip,ALPS,ROHM,Xilinx,Pulse,ON,Everlight and Freescale. Main products comprise IC,Modules,Potentiometer,IC Socket,Relay,Connector.Our parts cover such applications as commercial,industrial, and automotives areas.

We are looking forward to setting up business relationship with you and hope to provide you with the best service and solution. Let us make a better world for our industry!



Contact us

Tel: +86-755-8981 8866 Fax: +86-755-8427 6832

Email & Skype: info@chipsmall.com Web: www.chipsmall.com

Address: A1208, Overseas Decoration Building, #122 Zhenhua RD., Futian, Shenzhen, China



LSP05G European Version Module Series



Agency Approvals

Agency	Standard	Agency File Number
	UL1449	E320116

Applications

- Outdoor and Commercial LED Lighting
- Roadway lighting
- Traffic lighting
- Digital signage
- Wall wash lighting
- Parking garage lighting
- Flood lighting
- Tunnel lighting
- Street lighting

Additional Information



Datasheet



Resources



Samples

Description

Littelfuse's LSP05G European version thermally protected Surge Protective Device is a self-protected device specially designed to be used in outdoor and commercial LED lighting fixtures for transient overvoltage protection. It has been developed with Littelfuse's thermally protected varistor technology. Its built-in thermal disconnect function provides additional protection to prevent catastrophic failure and fire hazard even under extreme circumstances of varistor end-of-life or sustained over-voltage conditions. It also provides high line-to-earth/ground resistance, facilitating faster production line testing.

LSP05G series connected option allows clear indication of thermal fault protection by disconnecting power to the luminaire, thereby signaling SPD module replacement. The LSP05G Surge Protective Device facilitates product compliance to IEEE C62.41.2 Location Category C Low.

Features

- Maximum Discharge Current 10kA, 8/20 μ s
- Meets ANSI C136.2 Enhanced Level 10kV/5kA and IEEE C62.41.2 Location Category C Low Exposure
- Thermally Protected Varistor technology
- Parallel and Series Connected SPD Options
- IP66 Water-proof and Dust-proof
- UL1449 Recognized
- IEC 61643-11 Class II and EN 61643-11 Type 2 compliant.
- IEC CB Scheme Certificate NL-37684 available for 240V and NL-40516 for 277V
- Compact form factor with mounting tabs
- 240Vac and 277Vac are available for Class I and Class II installation based on IEC luminaire protection classes and are marked CE
- Series connected – Varistor thermal protection indication by removal of power to luminaire
- High line-to-earth/ground resistance
- RoHS compliant

Absolute Maximum Ratings

• For ratings of individual members of a series, see Device Ratings and Specifications chart

	LSP05G Series	Units
Continuous:		
Max AC Voltage Range ($V_{M(AC)(RMS)}$)	275 to 320	V
Continuous Current	5	A
Transient:		
Maximum Discharge Current, 8/20 μ s Waveform (I_{max})	10,000	A
Nominal Discharge Current, 8/20 μ s Waveform (I_n)	5,000	A
Operating Ambient Temperature Range (T_A)	-45 to +85	°C
Storage Temperature Range (T_{STG})	-45 to +90	°C
Isolation Voltage Capability (When the thermal disconnect opens)	600	V
Insulation Resistance	>1,000	M Ω

CAUTION: Stresses above those listed in "Absolute Maximum Ratings" may cause permanent damage to the device. This is a stress only rating and operation of the device at these or any other conditions above those indicated in the operational sections of this specification is not implied.

LSP05G European Version Series Device Ratings & Specifications

Part Number	Parallel/ Series	Operating Voltage (VAC)	MCOV/U _c ¹ (VAC)	Maximum Discharge Current ² I _{max} (A)	Nominal Discharge Current ³ I _n (A)	MLV ⁴ (V)	U _p ⁵ (V)	Safety Compliance		
								IEC/ EN61643-11 ⁶	Luminaire Class	UL1449
LSP05G240PX3333	P	240	275	10,000	5,000	L-N:970 L-G:1410 N-G:1410	L-N:1100 L-G:1600 N-G:1600		I	X
LSP05G240PX3316	P	240	275	10,000	5,000	L-N:970 L-G:1410 N-G:1410	L-N:1100 L-G:1600 N-G:1600		II	X
LSP05G240SX3333	S	240	275	10,000	5,000	L-N:970 L-G:1410 N-G:1410	L-N:1100 L-G:1600 N-G:1600	X	I	X
LSP05G240SX3316	S	240	275	10,000	5,000	L-N:970 L-G:1410 N-G:1410	L-N:1100 L-G:1600 N-G:1600	X	II	X
LSP05G277PX3333	P	277	320	10,000	5,000	L-N:1130 L-G:1410 N-G:1410	L-N:1200 L-G:1600 N-G:1600		I	X
LSP05G277PX3316	P	277	320	10,000	5,000	L-N:1130 L-G:1410 N-G:1410	L-N:1200 L-G:1600 N-G:1600		II	X
LSP05G277SX3333	S	277	320	10,000	5,000	L-N:1130 L-G:1410 N-G:1410	L-N:1200 L-G:1600 N-G:1600	X	I	X
LSP05G277SX3316	S	277	320	10,000	5,000	L-N:1130 L-G:1410 N-G:1410	L-N:1200 L-G:1600 N-G:1600	X	II	X

Glossary:

1. MCOV/U_c: Maximum Continuous Operating Voltage - maximum r.m.s. voltage that could be continuously applied to the SPD.
2. Maximum Discharge Current I_{max} (A): The maximum discharge current is a measure of the SPDs maximum capability; single impulse of discharge current uses the 8/20μs current waveform.
3. Nominal Discharge Current I_n (A): The nominal discharge current is a measure of the SPDs endurance capability; 15 impulses of discharge current uses the 8/20μs current waveform.
4. MLV: UL1449 Measured limiting voltage; the highest value of residual voltage measurements during the application of impulses of 8/20μs nominal discharge current (I_n); an average voltage value of 15 impulses
5. U_p: IEC 61643-11 Voltage protection level; the highest value of residual voltage measurements during the application of impulses of 8/20μs nominal discharge current (I_n); a rounding voltage value of maximum measurement.
6. Series module used in parallel connection for indication circuit connection.
7. LSP05G240S & LSP05G277S are certified by DEKRA with below IEC 61643-11 specifications.

LSP05G240S Specification	Parameter	Value	Unit	Condition
Temporary overvoltage TOV	U _T	337	V	LV system fault 255 V x 1.32 at t _r = 5 s, TN power grid
Temporary overvoltage TOV	U _T	442	V	LV system fault 255 V x 1.732 at t _r = 120 min, TN power grid
Power grids		TN		
Backup fuse		16	A	max., gG fuse
End of life indication		yes		Optical, light ON: SPD is functional Light OFF: SPD has reached end-of-life
Max earth leakage current at Uc		50	μA	Max. rms, to GND
LSP05G277S Specification	Parameter	Value	Unit	Condition
Temporary overvoltage TOV	U _T	403	V	LV system fault 305 V x 1.32 at t _r = 5 s, TN power grid
Temporary overvoltage TOV	U _T	529	V	LV system fault 305 V x 1.732 at t _r = 120 min, TN power grid
Power grids		TN		
Backup fuse		20	A	max., gG fuse
End of life indication		yes		Optical, light ON: SPD is functional Light OFF: SPD has reached end-of-life

LSP05G Protection Levels Up

LSP05G240S			LSP05G277S		
I _c 8/20 μS	Differential mode U ₂	Common mode U ₁ /U ₂	I _c 8/20 μS	Differential mode U ₂	Common mode U ₁ /U ₂
5kA	970V	1600V/1410V	5kA	1130V	1600V/1410V

Notes:

- It is normal practice to disconnect components that intentionally breakdown between Line and Protective Earth, otherwise the apparent leakage current measured by the Hi-Pot tester may incorrectly be judged a "failure."
- Maximum Discharge Current I_{max} (A): The maximum discharge current is a measure of the SPDs maximum capability; single impulse of discharge current uses the 8/20μs current waveform. All Devices pass maximum discharge current with possible, safe opening of thermal disconnect.

Dimensions

Series Version

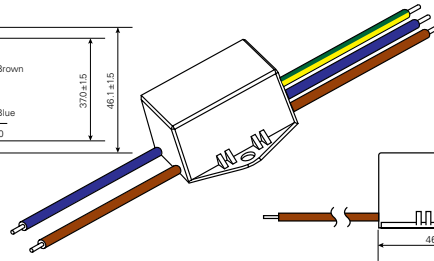
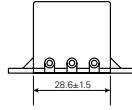
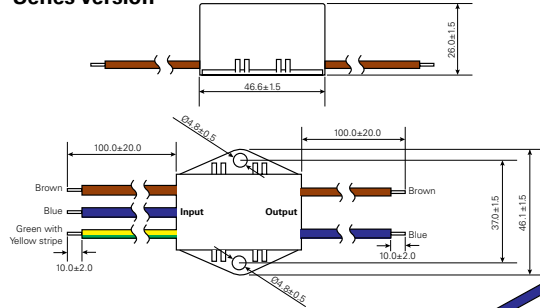

Parallel Version

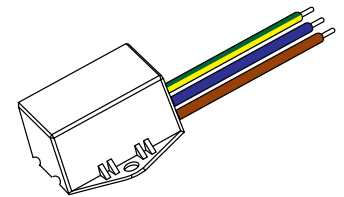
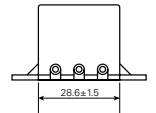
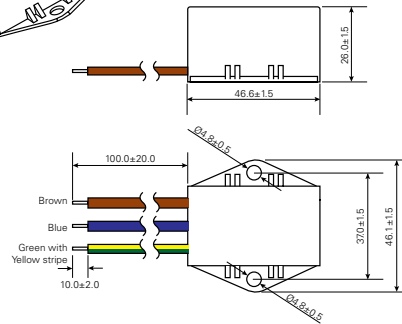

Notes:

1. Brown: Line; Blue: Neutral; Green-Yellow Stripe: Earth/Ground.
2. Wire Gauge: AWG16 (1.31mm²), wire length: 100mm±20mm, wire stripping length: 10±2mm.
3. Caution: Line/neutral wires must be correctly connected to AC power grid. Wiring error on line/neutral polarity may cause module failure.

Application/Installation Schematic

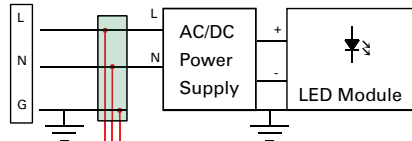

Parallel Connection

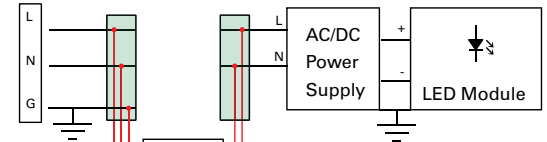

Series Connection

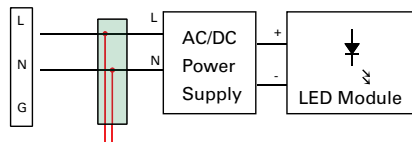

Parallel Connection
(for Class II Unearthed)

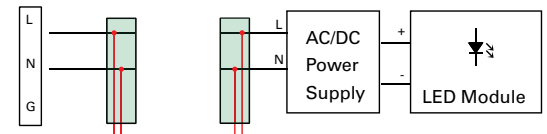

Series Connection
(for Class II Unearthed)

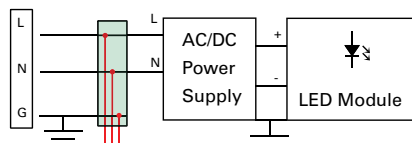

Parallel Connection
With LED indicating SPD status
- ON (green): SPD is online
- OFF: SPD needs replacement

Notes:

1. Series module used in parallel connection for indication circuit connection.
2. LED indicator and associated circuitry are not included in the module.
3. Brown wire is AC line voltage (hot); blue wire is AC neutral voltage.
4. Brown wire voltage is cut off when SPD needs replacement.
5. R is current limiting resistor; its resistance/wattage is determined by AC line voltage and desired current driving LED. Example: AC line voltage 240V, LED: 1.6mA, resistor: 150Kohm/0.5W.

Repetitive Surge Capability

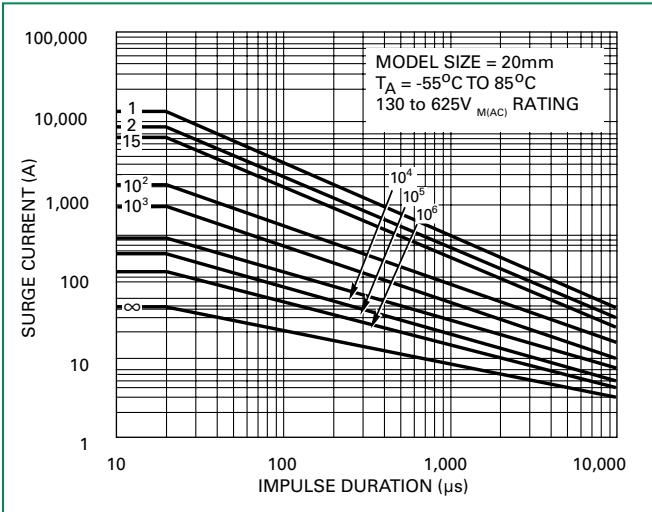

Pulse Rating (8x20µSec)	
Strikes	Surge
1	10,000A
2	7,000A
15	5,000A
100	1,500A
1,000	700A

Part Numbering System

