



Chipsmall Limited consists of a professional team with an average of over 10 year of expertise in the distribution of electronic components. Based in Hongkong, we have already established firm and mutual-benefit business relationships with customers from,Europe,America and south Asia,supplying obsolete and hard-to-find components to meet their specific needs.

With the principle of "Quality Parts,Customers Priority,Honest Operation,and Considerate Service",our business mainly focus on the distribution of electronic components. Line cards we deal with include Microchip,ALPS,ROHM,Xilinx,Pulse,ON,Everlight and Freescale. Main products comprise IC,Modules,Potentiometer,IC Socket,Relay,Connector.Our parts cover such applications as commercial,industrial, and automotives areas.

We are looking forward to setting up business relationship with you and hope to provide you with the best service and solution. Let us make a better world for our industry!



Contact us

Tel: +86-755-8981 8866 Fax: +86-755-8427 6832

Email & Skype: info@chipsmall.com Web: www.chipsmall.com

Address: A1208, Overseas Decoration Building, #122 Zhenhua RD., Futian, Shenzhen, China



FEATURES

- **Low Noise:** $20\mu\text{V}_{\text{RMS}}$ (10Hz to 100kHz)
- **Low Quiescent Current:** $25\mu\text{A}$
- **Wide Input Voltage Range:** 1.8V to 20V
- **Output Current:** 150mA
- **Very Low Shutdown Current:** $< 1\mu\text{A}$
- **Low Dropout Voltage:** 270mV
- No Protection Diodes Needed
- Fixed Output Voltages: 2.5V, 3V, 3.3V, 5V
- Adjustable Output from 1.22V to 20V
- Stable with $2.2\mu\text{F}$ Output Capacitor
- Stable with Aluminum, Tantalum or Ceramic Capacitors
- Reverse Battery Protection
- No Reverse Current
- Overcurrent and Overtemperature Protected
- 8-Lead MSOP Package

APPLICATIONS

- Cellular Phones
- Battery-Powered Systems
- Frequency Synthesizers
- Noise-Sensitive Instrumentation Systems

DESCRIPTION

The LT[®]1762 series are micropower, low noise, low dropout regulators. The devices are capable of supplying 150mA of output current with a dropout voltage of 270mV. Designed for use in battery-powered systems, the low $25\mu\text{A}$ quiescent current makes them an ideal choice. Quiescent current is well controlled; it does not rise in dropout as it does with many other regulators.

A key feature of the LT1762 regulators is low output noise. With the addition of an external $0.01\mu\text{F}$ bypass capacitor, output noise drops to $20\mu\text{V}_{\text{RMS}}$ over a 10Hz to 100kHz bandwidth. The LT1762 regulators are stable with output capacitors as low as $2.2\mu\text{F}$. Small ceramic capacitors can be used without the series resistance required by other regulators.

Internal protection circuitry includes reverse battery protection, current limiting, thermal limiting and reverse current protection. The parts come in fixed output voltages of 2.5V, 3V, 3.3V and 5V, and as an adjustable device with a 1.22V reference voltage. The LT1762 regulators are available in the 8-lead MSOP package.

LT, LT, LTC and LTM are registered trademarks of Linear Technology Corporation. All other trademarks are the property of their respective owners.

TYPICAL APPLICATION

3.3V Low Noise Regulator

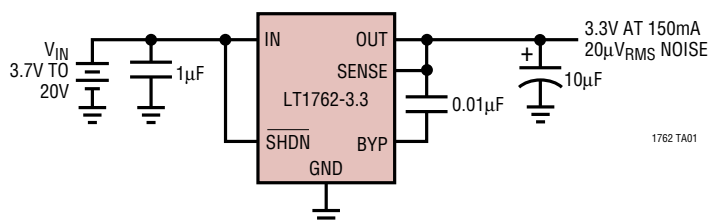

Dropout Voltage

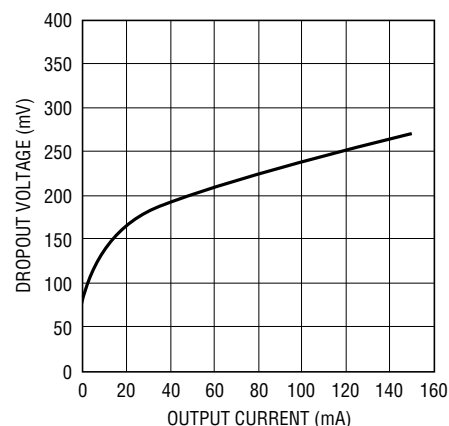

ABSOLUTE MAXIMUM RATINGS

(Note 1)

| | |
|--|----------------|
| IN Pin Voltage | ±20V |
| OUT Pin Voltage | ±20V |
| Input to Output Differential Voltage | ±20V |
| SENSE Pin Voltage | ±20V |
| ADJ Pin Voltage | ±7V |
| BYP Pin Voltage | ±0.6V |
| SHDN Pin Voltage | ±20V |
| Output Short-Circuit Duration | Indefinite |
| Operating Junction Temperature Range | |
| (Note 2) | −40°C to 125°C |
| Storage Temperature Range | −65°C to 150°C |
| Lead Temperature (Soldering, 10 sec) | 300°C |

Order Options Tape and Reel: Add #TR
 Lead Free: Add #PBF Lead Free Tape and Reel: Add #TRPBF
 Lead Free Part Marking: <http://www.linear.com/leadfree/>

PACKAGE/ORDER INFORMATION

| | |
|---|--|
| <p>TOP VIEW</p> <p>OUT 1 □ 8 IN SENSE/ADJ* 2 □ 7 NC BYP 3 □ 6 NC GND 4 □ 5 SHDN</p> <p>MS8 PACKAGE 8-LEAD PLASTIC MSOP</p> <p>*PIN 2: SENSE FOR LT1762-2.5/ LT1762-3/LT1762-3.3/LT1762-5 ADJ FOR LT1762</p> <p>T_{JMAX} = 150°C, θ_{JA} = 125°C/W</p> <p>SEE THE APPLICATIONS INFORMATION SECTION.</p> | ORDER PART NUMBER |
| | LT1762EMS8 LT1762EMS8-2.5 LT1762EMS8-3 LT1762EMS8-3.3 LT1762EMS8-5 |
| | MS8 PART MARKING |
| | LTHF LTHG LTHH LTHJ LTHK |

Consult factory for Industrial and Military grade parts.

ELECTRICAL CHARACTERISTICS

The ● denotes specifications which apply over the full operating temperature range, otherwise specifications are T_A = 25°C. (Note 2)

| PARAMETER | CONDITIONS | MIN | TYP | MAX | UNITS |
|--|---|-------|-----|-------|-------|
| Minimum Operating Voltage | I _{LOAD} = 150mA ● | | 1.8 | 2.3 | V |
| Regulated Output Voltage (Note 4) | LT1762-2.5 V _{IN} = 3V, I _{LOAD} = 1mA 3.5V < V _{IN} < 20V, 1mA < I _{LOAD} < 150mA ● | 2.475 | 2.5 | 2.525 | V |
| | LT1762-3 V _{IN} = 3.5V, I _{LOAD} = 1mA 4V < V _{IN} < 20V, 1mA < I _{LOAD} < 150mA ● | 2.435 | 2.5 | 2.565 | V |
| | LT1762-3.3 V _{IN} = 3.5V, I _{LOAD} = 1mA 4V < V _{IN} < 20V, 1mA < I _{LOAD} < 150mA ● | 2.970 | 3 | 3.030 | V |
| | LT1762-5 V _{IN} = 3.8V, I _{LOAD} = 1mA 4.3V < V _{IN} < 20V, 1mA < I _{LOAD} < 150mA ● | 2.925 | 3 | 3.075 | V |
| ADJ Pin Voltage (Notes 3, 4) | LT1762-3.3 V _{IN} = 3.8V, I _{LOAD} = 1mA 4.3V < V _{IN} < 20V, 1mA < I _{LOAD} < 150mA ● | 3.267 | 3.3 | 3.333 | V |
| | LT1762-5 V _{IN} = 5.5V, I _{LOAD} = 1mA 6V < V _{IN} < 20V, 1mA < I _{LOAD} < 150mA ● | 3.220 | 3.3 | 3.380 | V |
| Line Regulation | LT1762 V _{IN} = 2V, I _{LOAD} = 1mA 2.22V < V _{IN} < 20V, 1mA < I _{LOAD} < 150mA ● | 4.950 | 5 | 5.050 | V |
| | LT1762-2.5 ΔV _{IN} = 3V to 20V, I _{LOAD} = 1mA ● | 4.875 | 5 | 5.125 | V |
| | LT1762-3 ΔV _{IN} = 3.5V to 20V, I _{LOAD} = 1mA ● | | 1 | 5 | mV |
| | LT1762-3.3 ΔV _{IN} = 3.8V to 20V, I _{LOAD} = 1mA ● | | 1 | 5 | mV |
| | LT1762-5 ΔV _{IN} = 5.5V to 20V, I _{LOAD} = 1mA ● | | 1 | 5 | mV |
| LT1762 (Note 3) ΔV _{IN} = 2V to 20V, I _{LOAD} = 1mA ● | | 1 | 5 | mV | |
| Load Regulation | LT1762-2.5 V _{IN} = 3.5V, ΔI _{LOAD} = 1mA to 150mA ● | | 4 | 12 | mV |
| | LT1762-3 V _{IN} = 3.5V, ΔI _{LOAD} = 1mA to 150mA ● | | | 25 | mV |
| | LT1762-3 V _{IN} = 4V, ΔI _{LOAD} = 1mA to 150mA ● | | 4 | 15 | mV |
| | LT1762-3.3 V _{IN} = 4V, ΔI _{LOAD} = 1mA to 150mA ● | | | 30 | mV |
| | LT1762-3.3 V _{IN} = 4.3V, ΔI _{LOAD} = 1mA to 150mA ● | | 5 | 17 | mV |
| LT1762-5 V _{IN} = 4.3V, ΔI _{LOAD} = 1mA to 150mA ● | | | 33 | mV | |
| LT1762-5 V _{IN} = 6V, ΔI _{LOAD} = 1mA to 150mA ● | | 9 | 25 | mV | |
| LT1762 (Note 3) V _{IN} = 6V, ΔI _{LOAD} = 1mA to 150mA ● | | | 50 | mV | |
| LT1762 (Note 3) V _{IN} = 2.22V, ΔI _{LOAD} = 1mA to 150mA ● | | 1 | 6 | mV | |
| LT1762 (Note 3) V _{IN} = 2.22V, ΔI _{LOAD} = 1mA to 150mA ● | | | 12 | mV | |

1762fa

ELECTRICAL CHARACTERISTICS

The ● denotes specifications which apply over the full operating temperature range, otherwise specifications are $T_A = 25^\circ\text{C}$. (Note 2)

| PARAMETER | CONDITIONS | MIN | TYP | MAX | UNITS |
|--|--|-----|------|------|---------------|
| Dropout Voltage $V_{IN} = V_{OUT(NOMINAL)}$ (Notes 5, 6) | $I_{LOAD} = 1\text{mA}$ | ● | 0.09 | 0.15 | V |
| | $I_{LOAD} = 1\text{mA}$ | ● | | 0.19 | V |
| | $I_{LOAD} = 10\text{mA}$ | ● | 0.15 | 0.21 | V |
| | $I_{LOAD} = 10\text{mA}$ | ● | | 0.25 | V |
| GND Pin Current $V_{IN} = V_{OUT(NOMINAL)}$ (Notes 5, 7) | $I_{LOAD} = 0\text{mA}$ | ● | 25 | 65 | μA |
| | $I_{LOAD} = 1\text{mA}$ | ● | 70 | 120 | μA |
| | $I_{LOAD} = 10\text{mA}$ | ● | 350 | 500 | μA |
| | $I_{LOAD} = 50\text{mA}$ | ● | 1.3 | 1.8 | mA |
| Output Voltage Noise | $I_{LOAD} = 150\text{mA}$ | ● | 0.27 | 0.33 | V |
| | $I_{LOAD} = 150\text{mA}$ | ● | | 0.40 | V |
| ADJ Pin Bias Current | (Notes 3, 8) | | 30 | 100 | nA |
| Shutdown Threshold | $V_{OUT} = \text{Off to On}$ | ● | 0.8 | 2 | V |
| | $V_{OUT} = \text{On to Off}$ | ● | 0.25 | 0.65 | V |
| SHDN Pin Current (Note 9) | $V_{SHDN} = 0\text{V}$ | | 0.1 | | μA |
| | $V_{SHDN} = 20\text{V}$ | | 1 | | μA |
| Quiescent Current in Shutdown | $V_{IN} = 6\text{V}, V_{SHDN} = 0\text{V}$ | | 0.1 | 1 | μA |
| Ripple Rejection | $V_{IN} - V_{OUT} = 1\text{V (Avg)}, V_{RIPPLE} = 0.5\text{V}_{P-P}, f_{RIPPLE} = 120\text{Hz}, I_{LOAD} = 150\text{mA}$ | | 50 | 65 | dB |
| Current Limit | $V_{IN} = 7\text{V}, V_{OUT} = 0\text{V}$ | | 400 | | mA |
| | $V_{IN} = V_{OUT(NOMINAL)} + 1\text{V}, \Delta V_{OUT} = -0.1\text{V}$ | ● | 160 | | mA |
| Input Reverse Leakage Current | $V_{IN} = -20\text{V}, V_{OUT} = 0\text{V}$ | ● | | 1 | mA |
| Reverse Output Current (Note 10) | LT1762-2.5 $V_{OUT} = 2.5\text{V}, V_{IN} < 2.5\text{V}$ | | 10 | 20 | μA |
| | LT1762-3 $V_{OUT} = 3\text{V}, V_{IN} < 3\text{V}$ | | 10 | 20 | μA |
| | LT1762-3.3 $V_{OUT} = 3.3\text{V}, V_{IN} < 3.3\text{V}$ | | 10 | 20 | μA |
| | LT1762-5 $V_{OUT} = 5\text{V}, V_{IN} < 5\text{V}$ | | 10 | 20 | μA |
| | LT1762 (Note 3) $V_{OUT} = 1.22\text{V}, V_{IN} < 1.22\text{V}$ | | 5 | 10 | μA |

Note 1: Stresses beyond those listed under Absolute Maximum Ratings may cause permanent damage to the device. Exposure to any Absolute Maximum Rating condition for extended periods may affect device reliability and lifetime.

Note 2: The LT1762 regulators are tested and specified under pulse load conditions such that $T_J \approx T_A$. The LT1762 is 100% tested at 25°C . Performance at -40°C and 125°C is assured by design, characterization and correlation with statistical process controls.

Note 3: The LT1762 (adjustable version) is tested and specified for these conditions with the ADJ pin connected to the OUT pin.

Note 4: Operating conditions are limited by maximum junction temperature. The regulated output voltage specification will not apply for all possible combinations of input voltage and output current. When operating at maximum input voltage, the output current range must be limited. When operating at maximum output current, the input voltage range must be limited.

Note 5: To satisfy requirements for minimum input voltage, the LT1762 (adjustable version) is tested and specified for these conditions with an external resistor divider (two 250k resistors) for an output voltage of 2.44V. The external resistor divider will add a $5\mu\text{A}$ DC load on the output.

Note 6: Dropout voltage is the minimum input to output voltage differential needed to maintain regulation at a specified output current. In dropout, the output voltage will be equal to: $V_{IN} - V_{DROPOUT}$.

Note 7: GND pin current is tested with $V_{IN} = V_{OUT(NOMINAL)}$ and a current source load. This means the device is tested while operating in its dropout region. This is the worst-case GND pin current. The GND pin current will decrease slightly at higher input voltages.

Note 8: ADJ pin bias current flows into the ADJ pin.

Note 9: SHDN pin current flows into the SHDN pin.

Note 10: Reverse output current is tested with the IN pin grounded and the OUT pin forced to the rated output voltage. This current flows into the OUT pin and out the GND pin.

TYPICAL PERFORMANCE CHARACTERISTICS

Typical Dropout Voltage

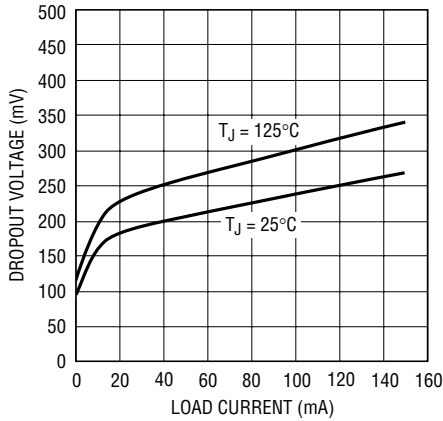

1762 G01

Guaranteed Dropout Voltage

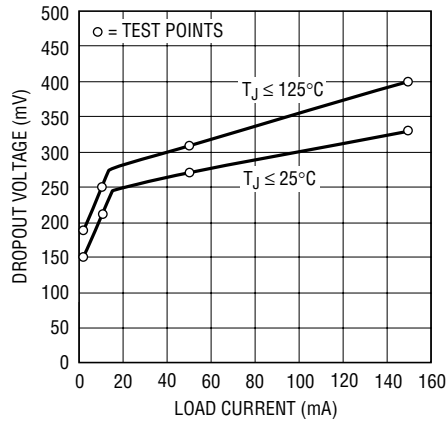

1762 G02

Dropout Voltage

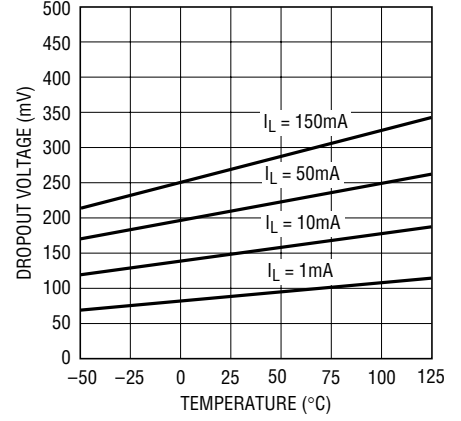

1762 G03

Quiescent Current

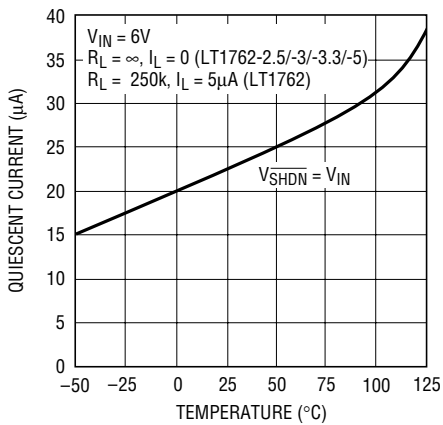

1762 G04

LT1762-2.5 Output Voltage

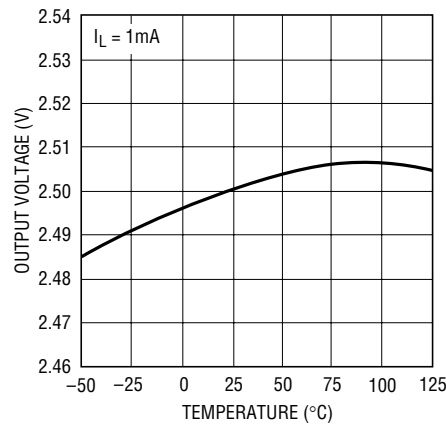

1762 G05

LT1762-3 Output Voltage

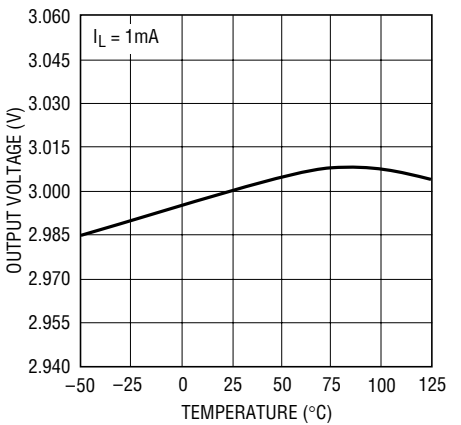

1762 G06

LT1762-3.3 Output Voltage

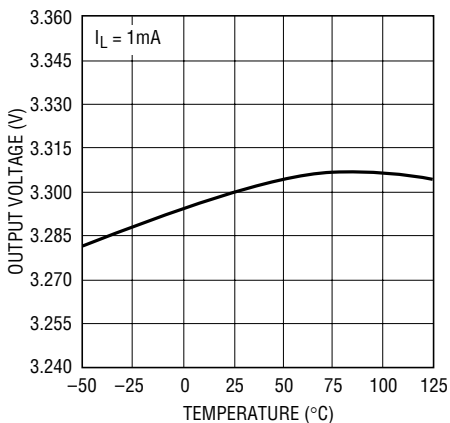

1762 G07

LT1762-5 Output Voltage

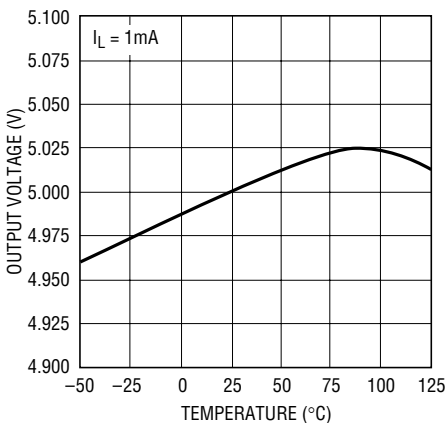

1762 G08

LT1762 ADJ Pin Voltage

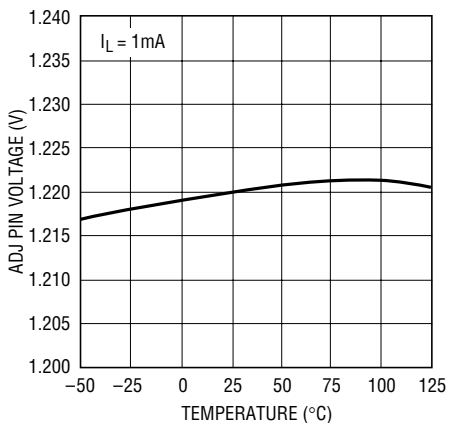

1762 G09

TYPICAL PERFORMANCE CHARACTERISTICS

LT1762-2.5
Quiescent Current

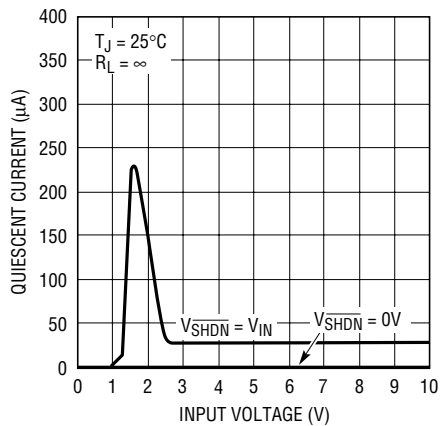

1762 G10

LT1762-3
Quiescent Current

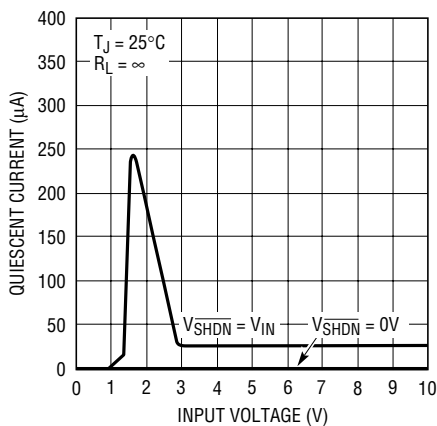

1762 G11

LT1762-3.3
Quiescent Current

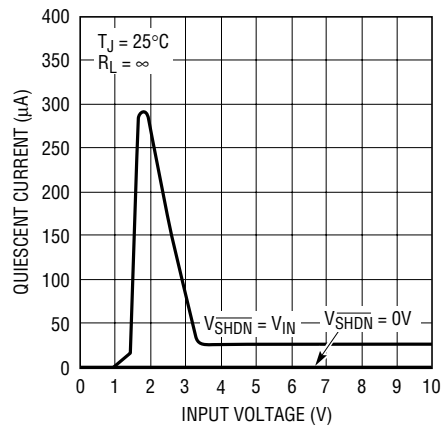

1762 G12

LT1762-5
Quiescent Current

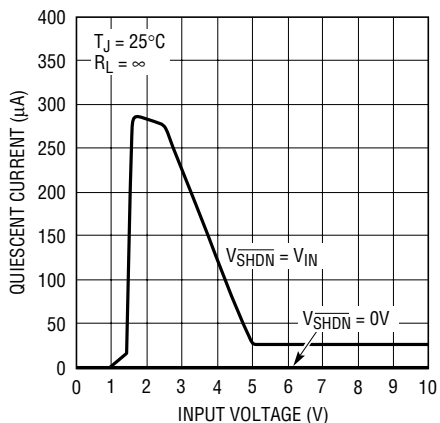

1762 G13

LT1762
Quiescent Current

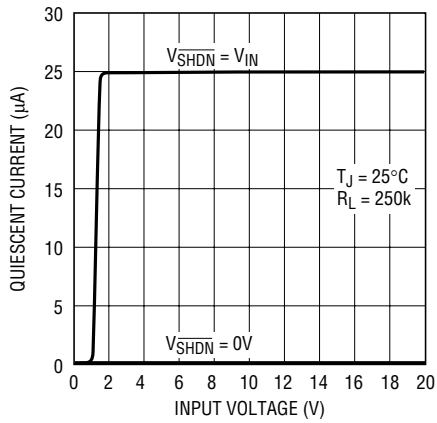

1762 G14

LT1762-2.5
GND Pin Current

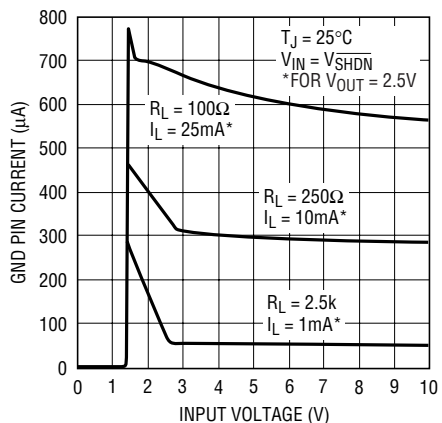

1762 G15

LT1762-3
GND Pin Current

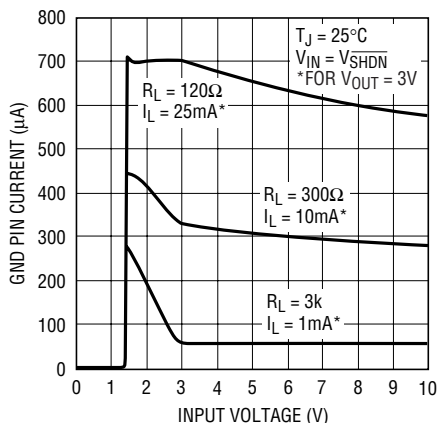

1762 G16

LT1762-3.3
GND Pin Current

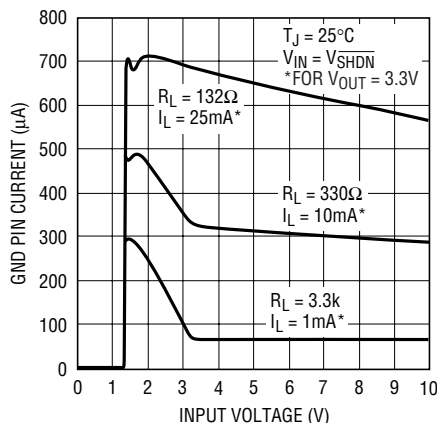

1762 G17

LT1762-5
GND Pin Current

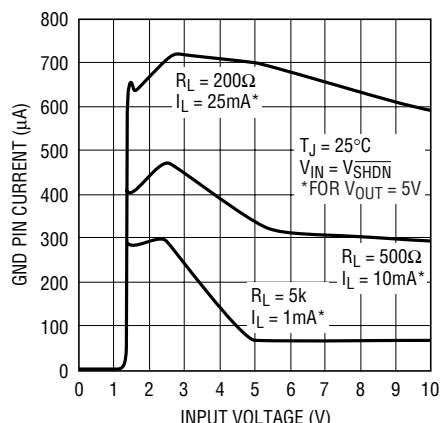

1762 G18

TYPICAL PERFORMANCE CHARACTERISTICS

LT1762
GND Pin Current

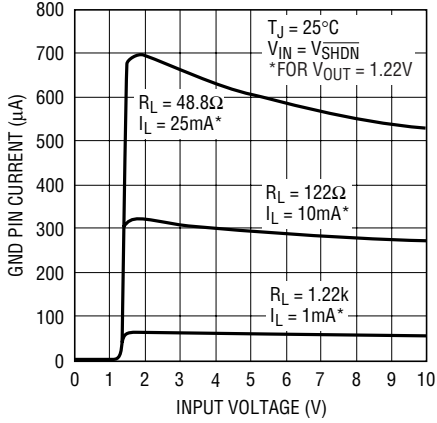

1762 G19

LT1762-2.5
GND Pin Current

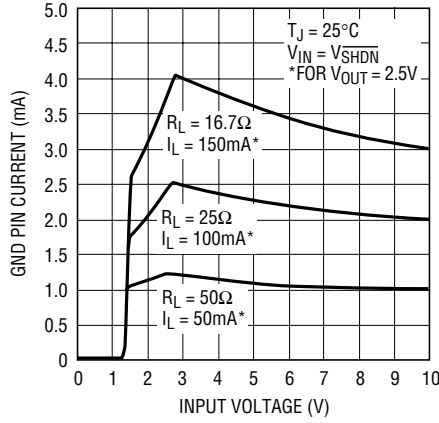

1762 G20

LT1762-3
GND Pin Current

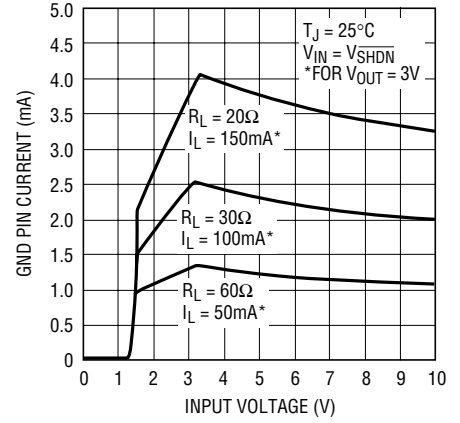

1762 G21

LT1762-3.3
GND Pin Current

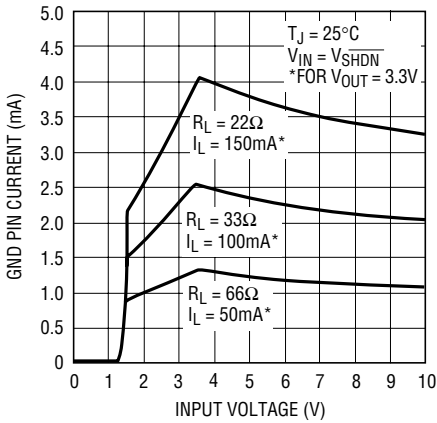

1762 G22

LT1762-5
GND Pin Current

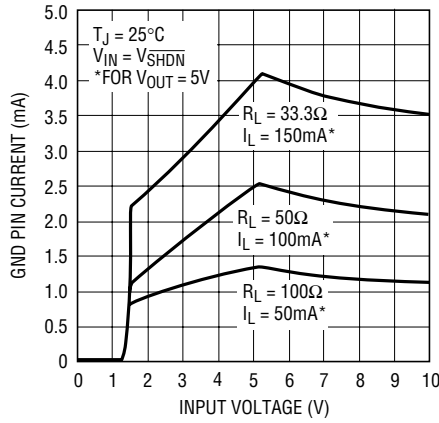

1762 G23

LT1762
GND Pin Current

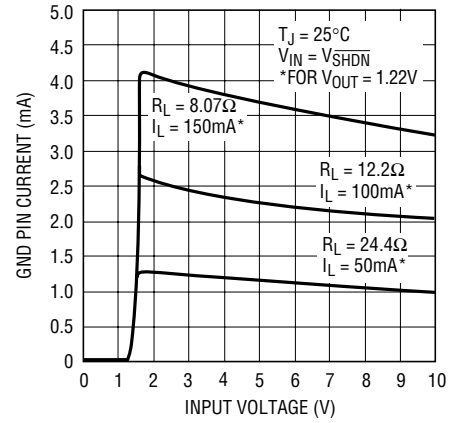

1762 G24

GND Pin Current vs $I_{L,LOAD}$

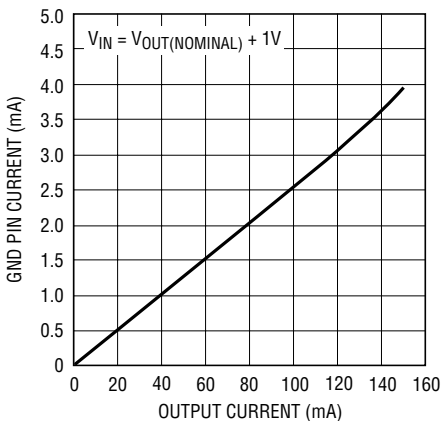

1762 G25

SHDN Pin Threshold
(On-to-Off)

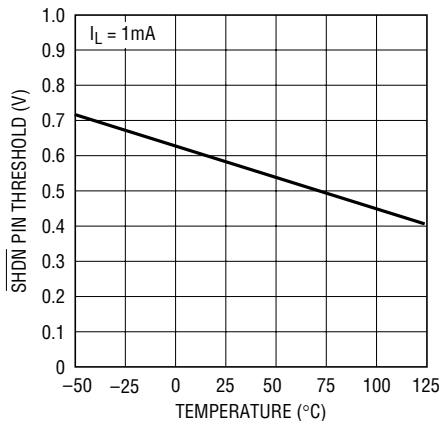

1762 G26

SHDN Pin Threshold
(Off-to-On)

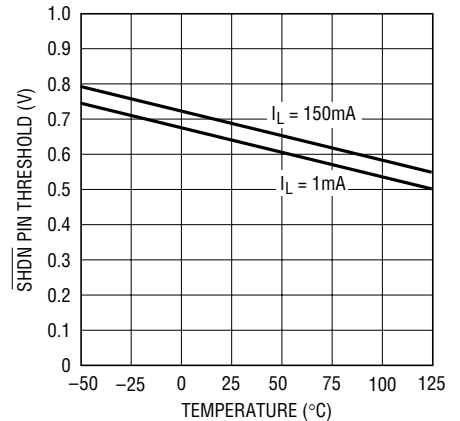

1762 G27

TYPICAL PERFORMANCE CHARACTERISTICS

SHDN Pin Input Current

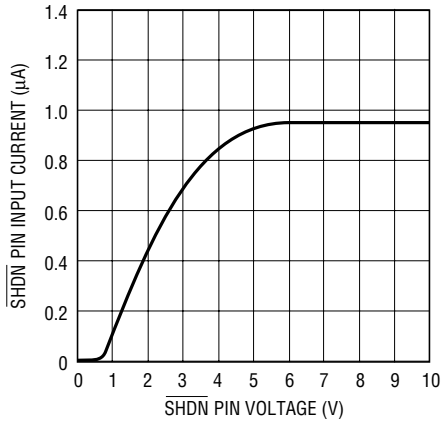

SHDN Pin Input Current

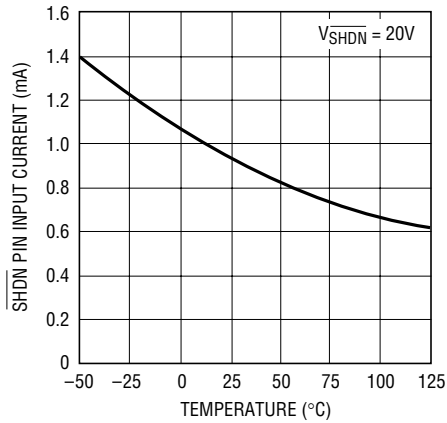

ADJ Pin Bias Current

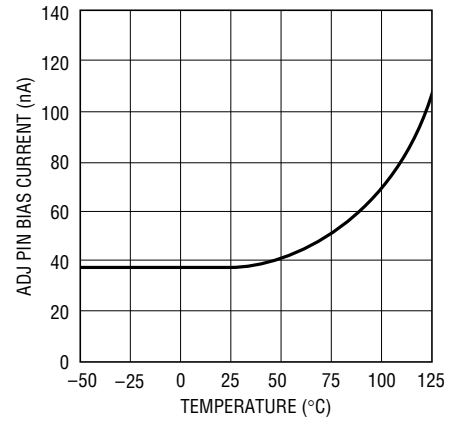

Current Limit

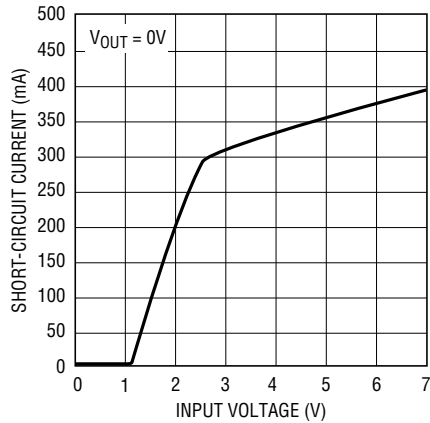

Current Limit

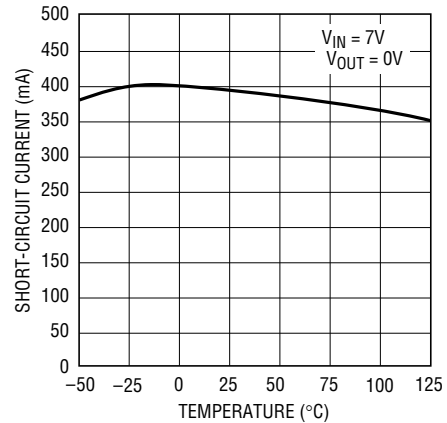

Reverse Output Current

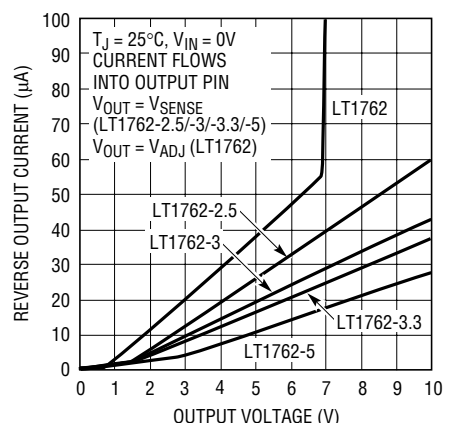

Reverse Output Current

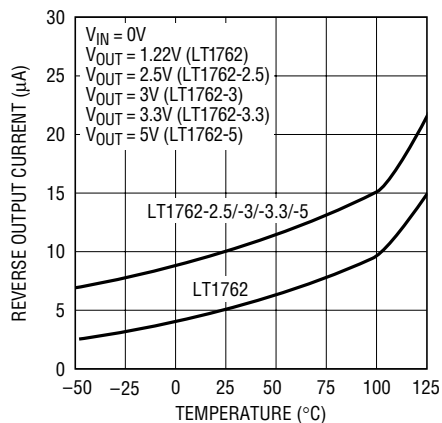

Input Ripple Rejection

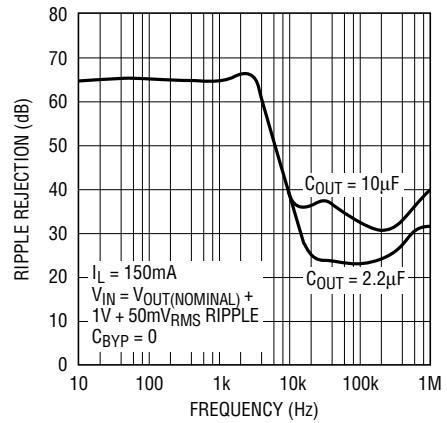

Input Ripple Rejection

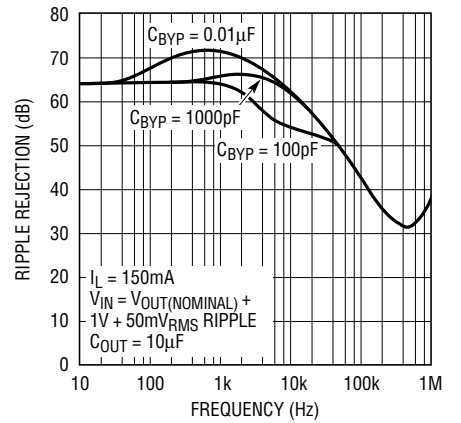

TYPICAL PERFORMANCE CHARACTERISTICS

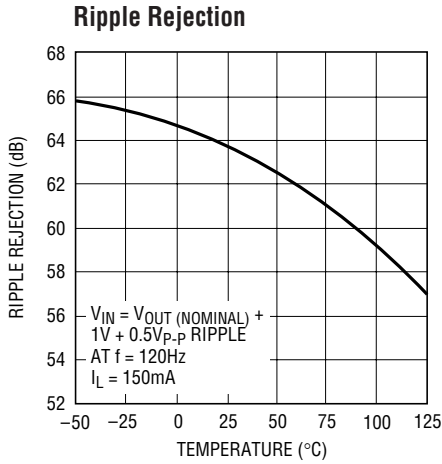

1762 G37

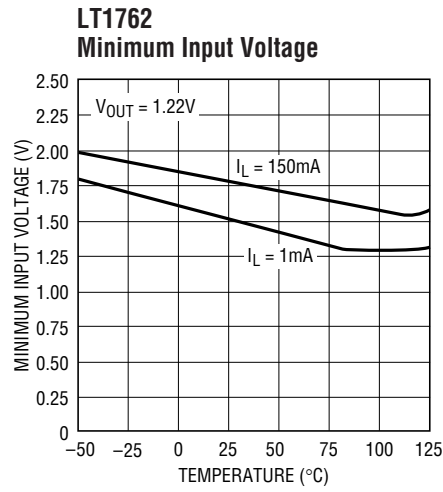

1762 G38

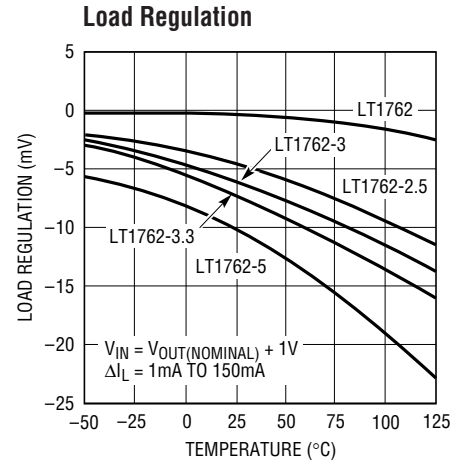

1762 G39

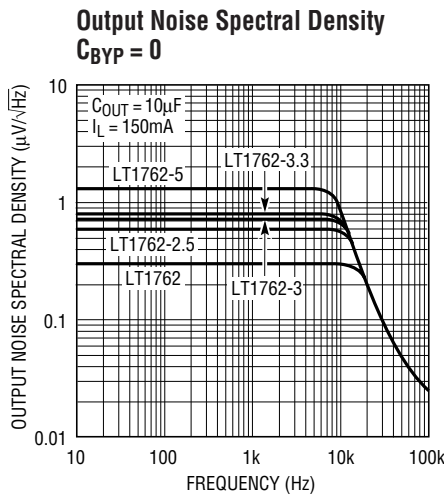

1762 G40

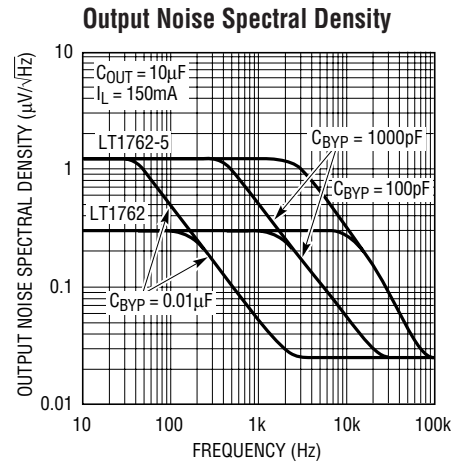

1762 G41

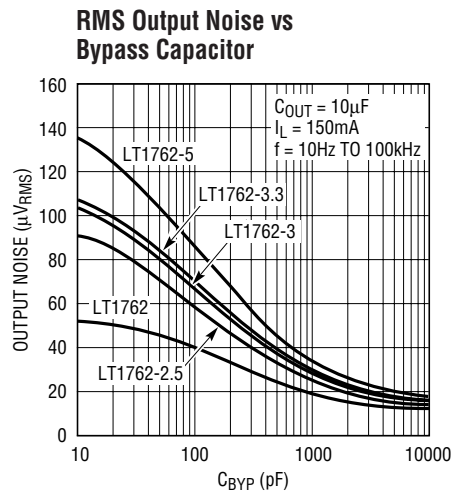

1762 G42

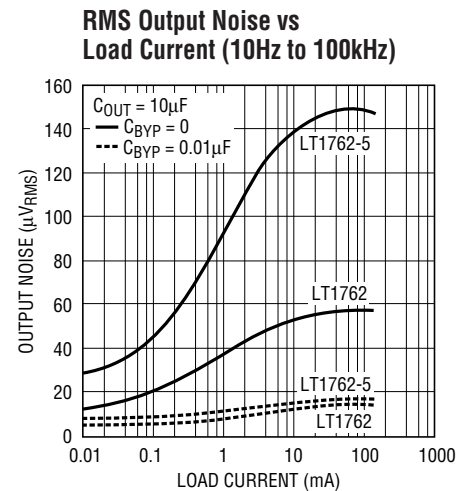

1762 G43

TYPICAL PERFORMANCE CHARACTERISTICS

LT1762-5
10Hz to 100kHz Output Noise
 $C_{BYP} = 0$

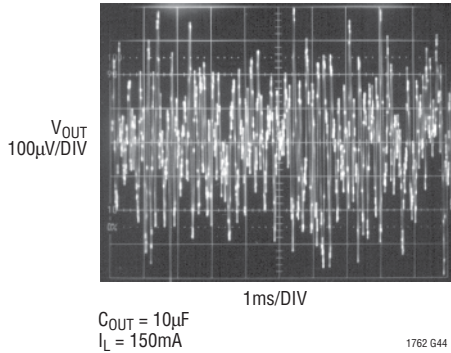

LT1762-5
10Hz to 100kHz Output Noise
 $C_{BYP} = 100pF$

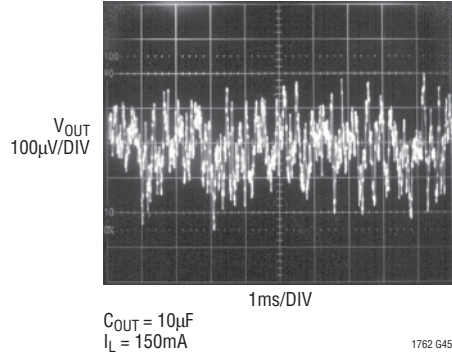

LT1762-5
10Hz to 100kHz Output Noise
 $C_{BYP} = 1000pF$

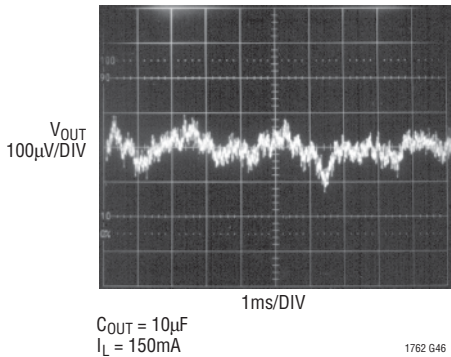

LT1762-5
10Hz to 100kHz Output Noise
 $C_{BYP} = 0.01µF$

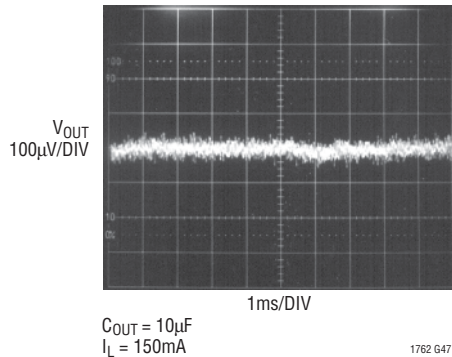

LT1762-5
Transient Response
 $C_{BYP} = 0$

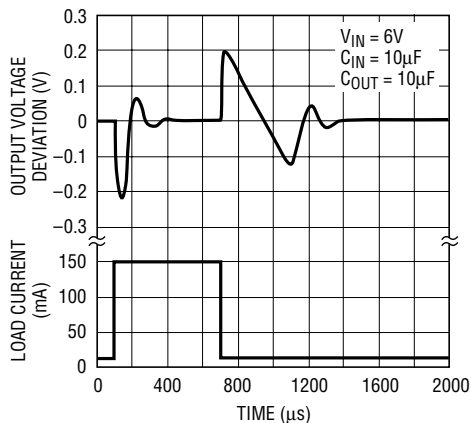

LT1762-5
Transient Response
 $C_{BYP} = 0.01µF$

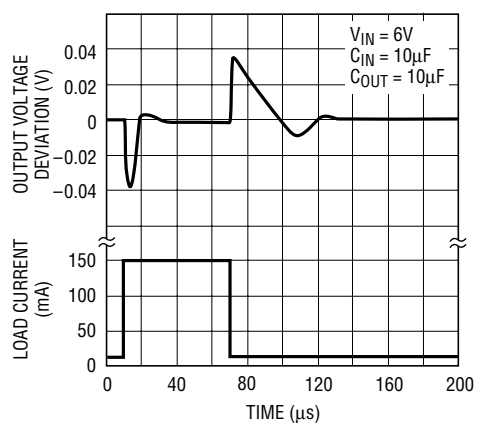

PIN FUNCTIONS

OUT (Pin 1): Output. The output supplies power to the load. A minimum output capacitor of 2.2 μ F is required to prevent oscillations. Larger output capacitors will be required for applications with large transient loads to limit peak voltage transients. See the Applications Information section for more information on output capacitance and reverse output characteristics.

SENSE (Pin 2): Output Sense. For fixed voltage versions of the LT1762 (LT1762-2.5/LT1762-3/LT1762-3.3/LT1762-5), the SENSE pin is the input to the error amplifier. Optimum regulation will be obtained at the point where the SENSE pin is connected to the OUT pin of the regulator. In critical applications, small voltage drops are caused by the resistance (R_P) of PC traces between the regulator and the load. These may be eliminated by connecting the SENSE pin to the output at the load as shown in Figure 1 (Kelvin Sense Connection). Note that the voltage drop across the external PC traces will add to the dropout voltage of the regulator. The SENSE pin bias current is 10 μ A at the nominal rated output voltage. The SENSE pin can be pulled below ground (as in a dual supply system where the regulator load is returned to a negative supply) and still allow the device to start and operate.

ADJ (Pin 2): Adjust. For the adjustable LT1762, this is the input to the error amplifier. This pin is internally clamped to $\pm 7V$. It has a bias current of 30nA which flows into the pin (see curve of ADJ Pin Bias Current vs Temperature in the Typical Performance Characteristics). The ADJ pin voltage is 1.22V referenced to ground and the output voltage range is 1.22V to 20V.

BYP (Pins 3): Bypass. The BYP pin is used to bypass the reference of the LT1762 regulators to achieve low noise performance from the regulator. The BYP pin is clamped internally to $\pm 0.6V$ (one V_{BE}). A small capacitor from the output to this pin will bypass the reference to lower the output voltage noise. A maximum value of 0.01 μ F can be used for reducing output voltage noise to a typical 20 μ V_{RMS} over a 10Hz to 100kHz bandwidth. If not used, this pin must be left unconnected.

GND (Pin 4): Ground.

SHDN (Pin 5): Shutdown. The SHDN pin is used to put the LT1762 regulators into a low power shutdown state. The output will be off when the SHDN pin is pulled low. The SHDN pin can be driven either by 5V logic or open-collector logic with a pull-up resistor. The pull-up resistor is required to supply the pull-up current of the open-collector gate, normally several microamperes, and the SHDN pin current, typically 1 μ A. If unused, the SHDN pin must be connected to V_{IN} . The device will be in low power shutdown state if the SHDN pin is not connected.

IN (Pin 8): Input. Power is supplied to the device through the IN pin. A bypass capacitor is required on this pin if the device is more than six inches away from the main input filter capacitor. In general, the output impedance of a battery rises with frequency, so it is advisable to include a bypass capacitor in battery-powered circuits. A bypass capacitor in the range of 1 μ F to 10 μ F is sufficient. The LT1762 regulators are designed to withstand reverse voltages on the IN pin with respect to ground and the OUT pin. In the case of a reverse input, which can happen if a battery is plugged in backwards, the device will act as if there is a diode in series with its input. There will be no reverse current flow into the regulator and no reverse voltage will appear at the load. The device will protect both itself and the load.

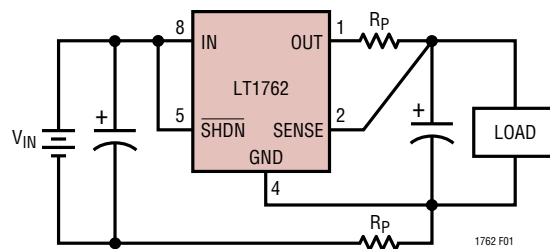

Figure 1. Kelvin Sense Connection

APPLICATIONS INFORMATION

The LT1762 series are 150mA low dropout regulators with micropower quiescent current and shutdown. The devices are capable of supplying 150mA at a dropout voltage of 270mV. Output voltage noise can be lowered to $20\mu\text{V}_{\text{RMS}}$ over a 10Hz to 100kHz bandwidth with the addition of a $0.01\mu\text{F}$ reference bypass capacitor. Additionally, the reference bypass capacitor will improve transient response of the regulator, lowering the settling time for transient load conditions. The low operating quiescent current ($25\mu\text{A}$) drops to less than $1\mu\text{A}$ in shutdown. In addition to the low quiescent current, the LT1762 regulators incorporate several protection features which make them ideal for use in battery-powered systems. The devices are protected against both reverse input and reverse output voltages. In battery backup applications where the output can be held up by a backup battery when the input is pulled to ground, the LT1762-X acts like it has a diode in series with its output and prevents reverse current flow. Additionally, in dual supply applications where the regulator load is returned to a negative supply, the output can be pulled below ground by as much as 20V and still allow the device to start and operate.

Adjustable Operation

The adjustable version of the LT1762 has an output voltage range of 1.22V to 20V. The output voltage is set by the ratio of two external resistors as shown in Figure 2. The device servos the output to maintain the ADJ pin voltage

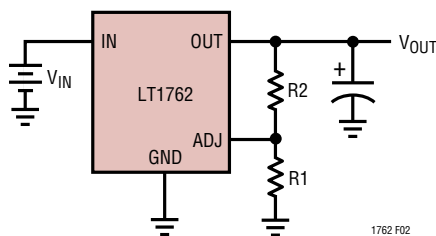

$$V_{\text{OUT}} = 1.22\text{V} \left(1 + \frac{R_2}{R_1} \right) + (I_{\text{ADJ}})(R_2)$$

$$V_{\text{ADJ}} = 1.22\text{V}$$

$$I_{\text{ADJ}} = 30\text{nA AT } 25^\circ\text{C}$$

$$\text{OUTPUT RANGE} = 1.22\text{V TO } 20\text{V}$$

Figure 2. Adjustable Operation

at 1.22V referenced to ground. The current in R1 is then equal to $1.22\text{V}/R_1$ and the current in R2 is the current in R1 plus the ADJ pin bias current. The ADJ pin bias current, 30nA at 25°C , flows through R2 into the ADJ pin. The output voltage can be calculated using the formula in Figure 2. The value of R1 should be no greater than 250k to minimize errors in the output voltage caused by the ADJ pin bias current. Note that in shutdown the output is turned off and the divider current will be zero. Curves of ADJ Pin Voltage vs Temperature and ADJ Pin Bias Current vs Temperature appear in the Typical Performance Characteristics section.

The adjustable device is tested and specified with the ADJ pin tied to the OUT pin for an output voltage of 1.22V. Specifications for output voltages greater than 1.22V will be proportional to the ratio of the desired output voltage to 1.22V: $V_{\text{OUT}}/1.22\text{V}$. For example, load regulation for an output current change of 1mA to 150mA is -1mV typical at $V_{\text{OUT}} = 1.22\text{V}$. At $V_{\text{OUT}} = 12\text{V}$, load regulation is:

$$(12\text{V}/1.22\text{V})(-1\text{mV}) = -9.8\text{mV}$$

Bypass Capacitance and Low Noise Performance

The LT1762 regulators may be used with the addition of a bypass capacitor from V_{OUT} to the BYP pin to lower output voltage noise. A good quality low leakage capacitor is recommended. This capacitor will bypass the reference of the regulator, providing a low frequency noise pole. The noise pole provided by this bypass capacitor will lower the output voltage noise to as low as $20\mu\text{V}_{\text{RMS}}$ with the addition of a $0.01\mu\text{F}$ bypass capacitor. Using a bypass capacitor has the added benefit of improving transient response. With no bypass capacitor and a $10\mu\text{F}$ output capacitor, a 10mA to 150mA load step will settle to within 1% of its final value in less than 100 μs . With the addition of a $0.01\mu\text{F}$ bypass capacitor, the output will stay within 1% for a 10mA to 150mA load step (see LT1762-5 Transient Response in the Typical Performance Characteristics). However, regulator start-up time is proportional to the size of the bypass capacitor, slowing to 15ms with a $0.01\mu\text{F}$ bypass capacitor and $10\mu\text{F}$ output capacitor.

APPLICATIONS INFORMATION

Output Capacitance and Transient Response

The LT1762 regulators are designed to be stable with a wide range of output capacitors. The ESR of the output capacitor affects stability, most notably with small capacitors. A minimum output capacitor of 2.2 μ F with an ESR of 3 Ω or less is recommended to prevent oscillations. The LT1762-X is a micropower device and output transient response will be a function of output capacitance. Larger values of output capacitance decrease the peak deviations and provide improved transient response for larger load current changes. Bypass capacitors, used to decouple individual components powered by the LT1762-X, will increase the effective output capacitor value. With larger capacitors used to bypass the reference (for low noise operation), larger values of output capacitors are needed. For 100pF of bypass capacitance, 3.3 μ F of output capacitor is recommended. With a 330pF bypass capacitor or larger, a 4.7 μ F output capacitor is recommended. The shaded region of Figure 3 defines the range over which the LT1762 regulators are stable. The minimum ESR needed is defined by the amount of bypass capacitance used, while the maximum ESR is 3 Ω .

Extra consideration must be given to the use of ceramic capacitors. Ceramic capacitors are manufactured with a variety of dielectrics, each with different behavior across temperature and applied voltage. The most common dielectrics used are specified with EIA temperature characteristic codes of Z5U, Y5V, X5R and X7R. The Z5U and Y5V dielectrics are good for providing high capacitances in a

small package, but they tend to have strong voltage and temperature coefficients as shown in Figures 4 and 5. When used with a 5V regulator, a 16V 10 μ F Y5V capacitor can exhibit an effective value as low as 1 μ F to 2 μ F for the DC bias voltage applied and over the operating temperature range. The X5R and X7R dielectrics result in more stable characteristics and are more suitable for use as the output capacitor. The X7R type has better stability across temperature, while the X5R is less expensive and is available in higher values. Care still must be exercised when using X5R and X7R capacitors; the X5R and X7R codes only specify operating temperature range and maximum capacitance change over temperature. Capacitance change due to DC bias with X5R and X7R capacitors is better than Y5V and Z5U capacitors, but can still be

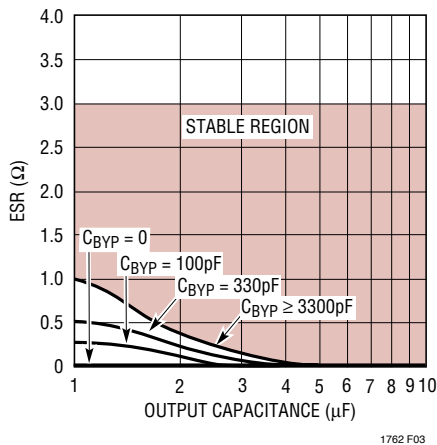

Figure 3. Stability

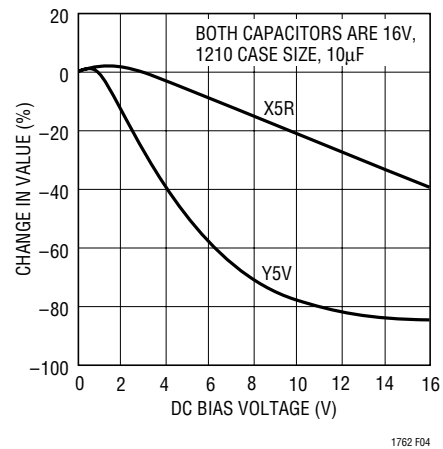

Figure 4. Ceramic Capacitor DC Bias Characteristics

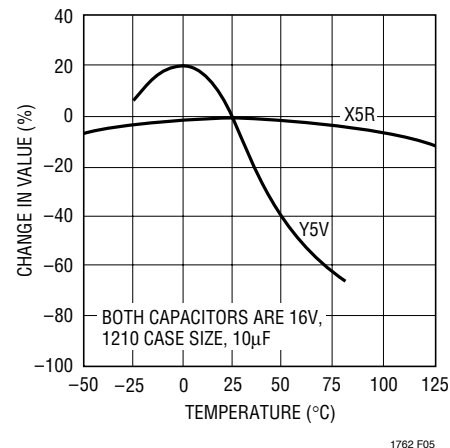

Figure 5. Ceramic Capacitor Temperature Characteristics

APPLICATIONS INFORMATION

significant enough to drop capacitor values below appropriate levels. Capacitor DC bias characteristics tend to improve as component case size increases, but expected capacitance at operating voltage should be verified.

Voltage and temperature coefficients are not the only sources of problems. Some ceramic capacitors have a piezoelectric response. A piezoelectric device generates voltage across its terminals due to mechanical stress, similar to the way a piezoelectric accelerometer or microphone works. For a ceramic capacitor the stress can be induced by vibrations in the system or thermal transients. The resulting voltages produced can cause appreciable amounts of noise, especially when a ceramic capacitor is used for noise bypassing. A ceramic capacitor produced Figure 6's trace in response to light tapping from a pencil.

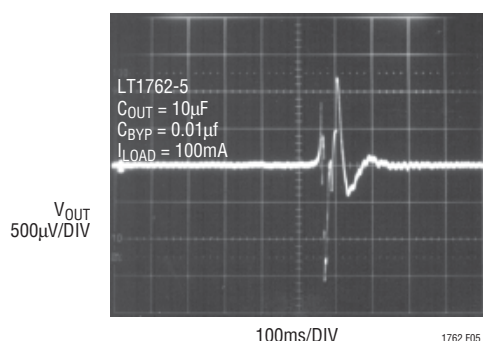

Figure 6. Noise Resulting from Tapping on a Ceramic Capacitor

Similar vibration induced behavior can masquerade as increased output voltage noise.

Thermal Considerations

The power handling capability of the device will be limited by the maximum rated junction temperature (125°C). The power dissipated by the device will be made up of two components:

1. Output current multiplied by the input/output voltage differential: $(I_{OUT})(V_{IN} - V_{OUT})$, and
2. GND pin current multiplied by the input voltage: $(I_{GND})(V_{IN})$.

The GND pin current can be found by examining the GND Pin Current curves in the Typical Performance Characteristics. Power dissipation will be equal to the sum of the two components listed above.

The LT1762 series regulators have internal thermal limiting designed to protect the device during overload conditions. For continuous normal conditions, the maximum junction temperature rating of 125°C must not be exceeded. It is important to give careful consideration to all sources of thermal resistance from junction to ambient. Additional heat sources mounted nearby must also be considered.

For surface mount devices, heat sinking is accomplished by using the heat spreading capabilities of the PC board and its copper traces. Copper board stiffeners and plated through-holes can also be used to spread the heat generated by power devices.

The following table lists thermal resistance for several different board sizes and copper areas. All measurements were taken in still air on 3/32" FR-4 board with one ounce copper.

Table 1. Measured Thermal Resistance

| COPPER AREA | | BOARD AREA | THERMAL RESISTANCE (JUNCTION-TO-AMBIENT) |
|---------------------|---------------------|---------------------|---|
| TOPSIDE* | BACKSIDE | | |
| 2500mm ² | 2500mm ² | 2500mm ² | 110°C/W |
| 1000mm ² | 2500mm ² | 2500mm ² | 115°C/W |
| 225mm ² | 2500mm ² | 2500mm ² | 120°C/W |
| 100mm ² | 2500mm ² | 2500mm ² | 130°C/W |
| 50mm ² | 2500mm ² | 2500mm ² | 140°C/W |

*Device is mounted on topside.

Calculating Junction Temperature

Example: Given an output voltage of 3.3V, an input voltage range of 4V to 6V, an output current range of 0mA to 50mA and a maximum ambient temperature of 50°C, what will the maximum junction temperature be?

The power dissipated by the device will be equal to:

$$I_{OUT(MAX)}(V_{IN(MAX)} - V_{OUT}) + I_{GND}(V_{IN(MAX)})$$

APPLICATIONS INFORMATION

where,

$$I_{OUT(MAX)} = 150\text{mA}$$

$$V_{IN(MAX)} = 6\text{V}$$

$$I_{GND} \text{ at } (I_{OUT} = 150\text{mA}, V_{IN} = 6\text{V}) = 5\text{mA}$$

So,

$$P = 150\text{mA}(6\text{V} - 3.3\text{V}) + 5\text{mA}(6\text{V}) = 0.44\text{W}$$

The thermal resistance will be in the range of 110°C/W to 140°C/W depending on the copper area. So the junction temperature rise above ambient will be approximately equal to:

$$0.44\text{W}(125^\circ\text{C/W}) = 55^\circ\text{C}$$

The maximum junction temperature will then be equal to the maximum junction temperature rise above ambient plus the maximum ambient temperature or:

$$T_{JMAX} = 50^\circ\text{C} + 55^\circ\text{C} = 105^\circ\text{C}$$

Protection Features

The LT1762 regulators incorporate several protection features which make them ideal for use in battery-powered circuits. In addition to the normal protection features associated with monolithic regulators, such as current limiting and thermal limiting, the devices are protected against reverse input voltages, reverse output voltages and reverse voltages from output to input.

Current limit protection and thermal overload protection are intended to protect the device against current overload conditions at the output of the device. For normal operation, the junction temperature should not exceed 125°C.

The input of the device will withstand reverse voltages of 20V. Current flow into the device will be limited to less than 1mA (typically less than 100µA) and no negative voltage will appear at the output. The device will protect both itself and the load. This provides protection against batteries which can be plugged in backward.

The output of the LT1762-X can be pulled below ground without damaging the device. If the input is left open circuit or grounded, the output can be pulled below ground by

20V. For fixed voltage versions, the output will act like a large resistor, typically 500kΩ or higher, limiting current flow to less than 100µA. For adjustable versions, the output will act like an open circuit; no current will flow out of the pin. If the input is powered by a voltage source, the output will source the short-circuit current of the device and will protect itself by thermal limiting. In this case, grounding the SHDN pin will turn off the device and stop the output from sourcing the short-circuit current.

The ADJ pin of the adjustable device can be pulled above or below ground by as much as 7V without damaging the device. If the input is left open circuit or grounded, the ADJ pin will act like an open circuit when pulled below ground and like a large resistor (typically 100k) in series with a diode when pulled above ground.

In situations where the ADJ pin is connected to a resistor divider that would pull the ADJ pin above its 7V clamp voltage if the output is pulled high, the ADJ pin input current must be limited to less than 5mA. For example, a resistor divider is used to provide a regulated 1.5V output from the 1.22V reference when the output is forced to 20V. The top resistor of the resistor divider must be chosen to limit the current into the ADJ pin to less than 5mA when the ADJ pin is at 7V. The 13V difference between output and ADJ pin divided by the 5mA maximum current into the ADJ pin yields a minimum top resistor value of 2.6k.

In circuits where a backup battery is required, several different input/output conditions can occur. The output voltage may be held up while the input is either pulled to ground, pulled to some intermediate voltage or is left open circuit. Current flow back into the output will follow the curve shown in Figure 7.

When the IN pin of the LT1762-X is forced below the OUT pin or the OUT pin is pulled above the IN pin, input current will typically drop to less than 2µA. This can happen if the input of the device is connected to a discharged (low voltage) battery and the output is held up by either a backup battery or a second regulator circuit. The state of the SHDN pin will have no effect on the reverse output current when the output is pulled above the input.

APPLICATIONS INFORMATION

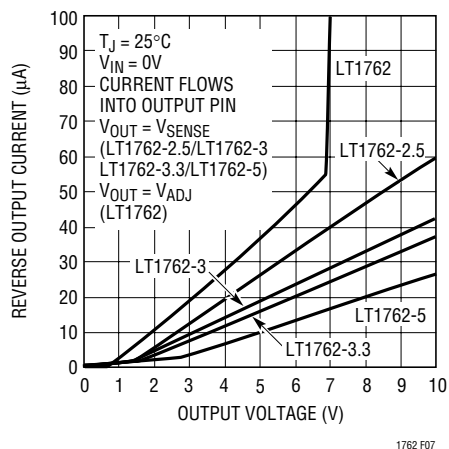
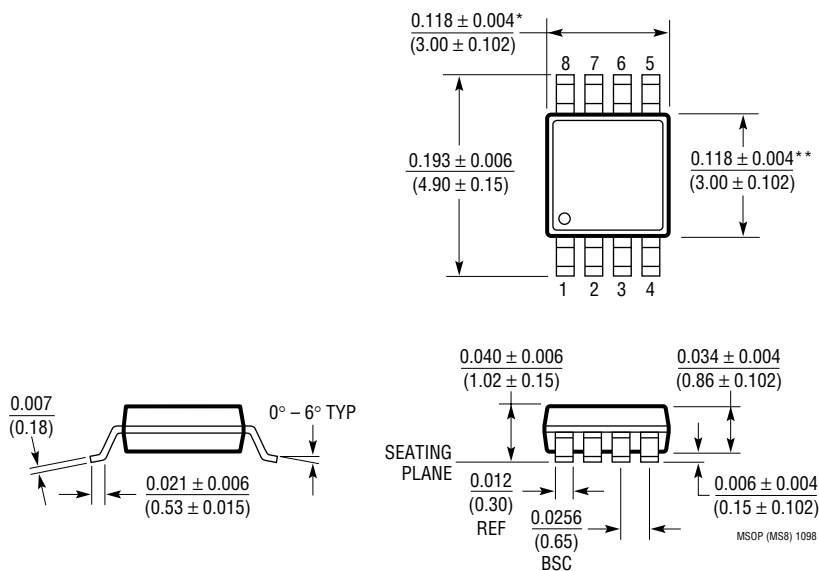

Figure 7. Reverse Output Current

PACKAGE DESCRIPTION

MS8 Package
8-Lead Plastic MSOP
 (LTC DWG # 05-08-1660)



* DIMENSION DOES NOT INCLUDE MOLD FLASH, PROTRUSIONS OR GATE BURRS. MOLD FLASH, PROTRUSIONS OR GATE BURRS SHALL NOT EXCEED 0.006" (0.152mm) PER SIDE

** DIMENSION DOES NOT INCLUDE INTERLEAD FLASH OR PROTRUSIONS. INTERLEAD FLASH OR PROTRUSIONS SHALL NOT EXCEED 0.006" (0.152mm) PER SIDE

TYPICAL APPLICATION

Paralleling of Regulators for Higher Output Current

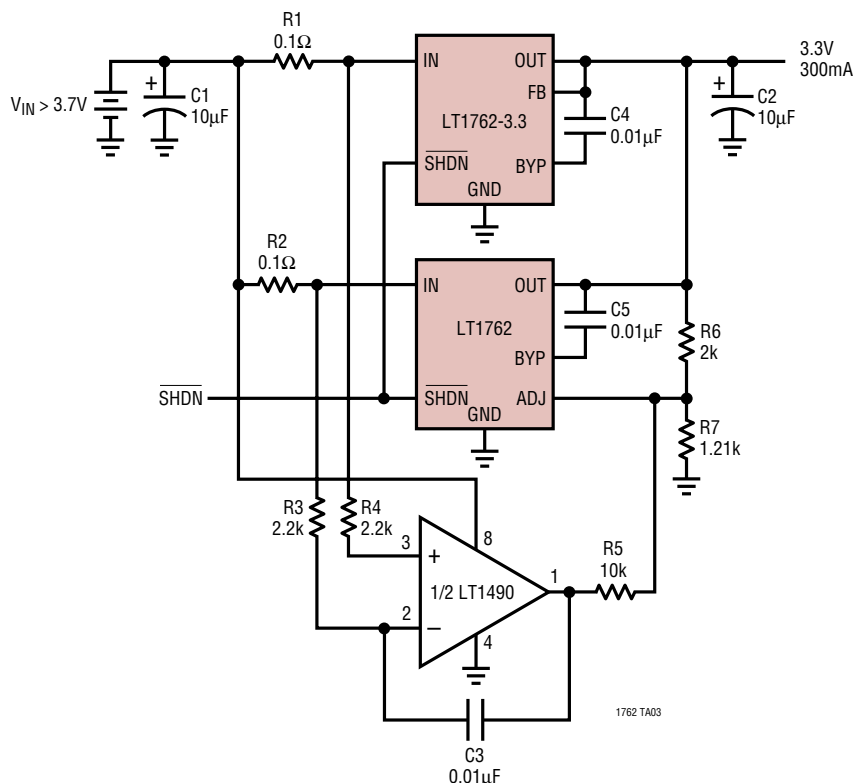

RELATED PARTS

| PART NUMBER | DESCRIPTION | COMMENTS |
|---------------|---|--|
| LT1120 | 125mA Low Dropout Regulator with 20µA I_Q | Includes 2.5V Reference and Comparator |
| LT1121 | 150mA Micropower Low Dropout Regulator | 30µA I_Q , SOT-223 Package |
| LT1129 | 700mA Micropower Low Dropout Regulator | 50µA Quiescent Current |
| LT1175 | 500mA Negative Low Dropout Micropower Regulator | 45µA I_Q , 0.26V Dropout Voltage, SOT-223 Package |
| LT1521 | 300mA Low Dropout Micropower Regulator with Shutdown | 15µA I_Q , Reverse Battery Protection |
| LT1529 | 3A Low Dropout Regulator with 50µA I_Q | 500mV Dropout Voltage |
| LT1611 | Inverting 1.4MHz Switching Regulator | 5V to -5V at 150mA, Low Output Noise, SOT-23 Package |
| LT1613 | 1.4MHz Single-Cell Micropower DC/DC Converter | SOT-23 Package, Internally Compensated |
| LTC1627 | High Efficiency Synchronous Step-Down Switching Regulator | Burst Mode™ Operation, Monolithic, 100% Duty Cycle |
| LT1761 Series | 100mA, Low Noise, Low Dropout Micropower Regulators in SOT-23 | 20µA Quiescent Current, 20µV _{RMS} Noise |
| LT1763 Series | 500mA, Low Noise, LDO Micropower Regulators | 30µA Quiescent Current, 20µV _{RMS} Noise |

Burst Mode is a trademark of Linear Technology Corporation.