



Chipsmall Limited consists of a professional team with an average of over 10 year of expertise in the distribution of electronic components. Based in Hongkong, we have already established firm and mutual-benefit business relationships with customers from,Europe,America and south Asia,supplying obsolete and hard-to-find components to meet their specific needs.

With the principle of “Quality Parts,Customers Priority,Honest Operation,and Considerate Service”,our business mainly focus on the distribution of electronic components. Line cards we deal with include Microchip,ALPS,ROHM,Xilinx,Pulse,ON,Everlight and Freescale. Main products comprise IC,Modules,Potentiometer,IC Socket,Relay,Connector.Our parts cover such applications as commercial,industrial, and automotives areas.

We are looking forward to setting up business relationship with you and hope to provide you with the best service and solution. Let us make a better world for our industry!



Contact us

Tel: +86-755-8981 8866 Fax: +86-755-8427 6832

Email & Skype: info@chipsmall.com Web: www.chipsmall.com

Address: A1208, Overseas Decoration Building, #122 Zhenhua RD., Futian, Shenzhen, China



High Input Voltage, Boost, Flyback, SEPIC and Inverting Controller

FEATURES

- **Wide Input Voltage Range: 5.5V to 100V**
- **Positive or Negative Output Voltage Programming with a Single Feedback Pin**
- Current Mode Control Provides Excellent Transient Response
- Programmable Operating Frequency (100kHz to 1MHz) with One External Resistor
- Synchronizable to an External Clock
- Low Shutdown Current < 1 μ A
- Internal 7.2V Low Dropout Voltage Regulator
- Programmable Input Undervoltage Lockout with Hysteresis
- Programmable Soft-Start
- Small 10-Lead DFN (3mm \times 3mm) and MSOPE Packages

APPLICATIONS

- Automotive
- Telecom
- Industrial

LT, LT, LTC, LTM, Linear Technology, the Linear logo and Burst Mode are registered trademarks and No R_{SENSE} and ThinSOT are trademarks of Linear Technology Corporation. All other trademarks are the property of their respective owners. Patents pending.

DESCRIPTION

The LT[®]3758/LT3758A are wide input range, current mode, DC/DC controllers which are capable of generating either positive or negative output voltages. They can be configured as either a boost, flyback, SEPIC or inverting converter. The LT3758/LT3758A drive a low side external N-channel power MOSFET from an internal regulated 7.2V supply. The fixed frequency, current-mode architecture results in stable operation over a wide range of supply and output voltages.

The operating frequency of LT3758/LT3758A can be set with an external resistor over a 100kHz to 1MHz range, and can be synchronized to an external clock using the SYNC pin. A minimum operating supply voltage of 5.5V, and a low shutdown quiescent current of less than 1 μ A, make the LT3758/LT3758A ideally suited for battery-powered systems.

The LT3758/LT3758A feature soft-start and frequency foldback functions to limit inductor current during start-up and output short-circuit. The LT3758A has improved load transient performance compared to the LT3758.

TYPICAL APPLICATION

12V Output Nonisolated Flyback Power Supply

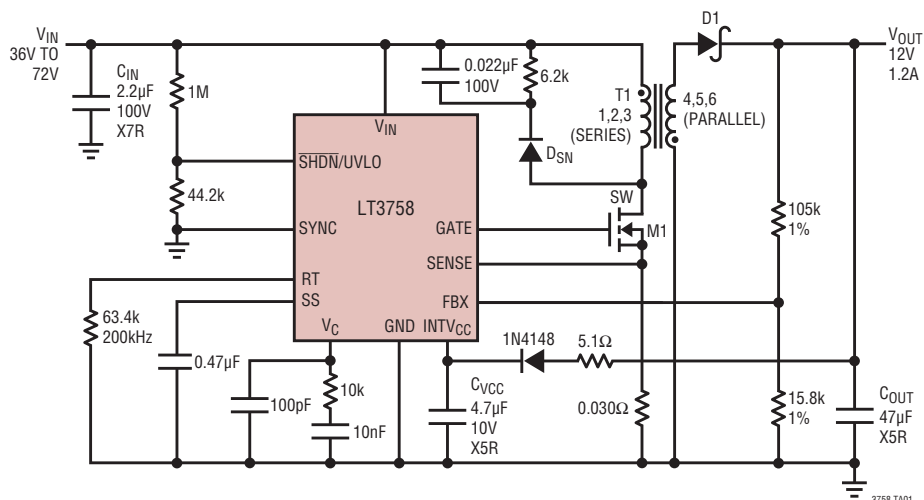

3758 TA01

3758afd

LT3758/LT3758A

ABSOLUTE MAXIMUM RATINGS (Note 1)

V_{IN} , SHDN/UVLO (Note 7)	100V
INTV _{CC}	$V_{IN} + 0.3V$, 20V
GATE	INTV _{CC} + 0.3V
SYNC	8V
V_C , SS	3V
RT	1.5V
SENSE	±0.3V
FBX	-6V to 6V

Operating Junction Temperature Range (Notes 2, 8)	
LT3758E/LT3758AE	-40°C to 125°C
LT3758I/LT3758AI	-40°C to 125°C
LT3758H/LT3758AH	-40°C to 150°C
LT3758MP/LT3758AMP	-55°C to 150°C
Storage Temperature Range	
DFN	-65°C to 125°C
MSOP	-65°C to 150°C
Lead Temperature (Soldering, 10 sec)	
MSOP	300°C

PIN CONFIGURATION



ORDER INFORMATION

LEAD FREE FINISH	TAPE AND REEL	PART MARKING*	PACKAGE DESCRIPTION	TEMPERATURE RANGE
LT3758EDD#PBF	LT3758EDD#TRPBF	LDNK	10-Lead (3mm × 3mm) Plastic DFN	-40°C to 125°C
LT3758IDD#PBF	LT3758IDD#TRPBF	LDNK	10-Lead (3mm × 3mm) Plastic DFN	-40°C to 125°C
LT3758EMSE#PBF	LT3758EMSE#TRPBF	LTDNM	10-Lead (3mm × 3mm) Plastic MSOP	-40°C to 125°C
LT3758IMSE #PBF	LT3758IMSE#TRPBF	LTDNM	10-Lead (3mm × 3mm) Plastic MSOP	-40°C to 125°C
LT3758HMSE#PBF	LT3758HMSE#TRPBF	LTDNM	10-Lead (3mm × 3mm) Plastic MSOP	-40°C to 150°C
LT3758MPMSE #PBF	LT3758MPMSE#TRPBF	LTDNM	10-Lead (3mm × 3mm) Plastic MSOP	-55°C to 150°C
LT3758AEDD#PBF	LT3758AEDD#TRPBF	LGGS	10-Lead (3mm × 3mm) Plastic DFN	-40°C to 125°C
LT3758AIDD#PBF	LT3758AIDD#TRPBF	LGGS	10-Lead (3mm × 3mm) Plastic DFN	-40°C to 125°C
LT3758AEMSE#PBF	LT3758AEMSE#TRPBF	LTGGK	10-Lead (3mm × 3mm) Plastic MSOP	-40°C to 125°C
LT3758AIMSE#PBF	LT3758AIMSE#TRPBF	LTGGK	10-Lead (3mm × 3mm) Plastic MSOP	-40°C to 125°C
LT3758AHMSE#PBF	LT3758AHMSE#TRPBF	LTGGK	10-Lead (3mm × 3mm) Plastic MSOP	-40°C to 150°C
LT3758AMPMSE#PBF	LT3758AMPMSE#TRPBF	LTGGK	10-Lead (3mm × 3mm) Plastic MSOP	-55°C to 150°C

Consult LTC Marketing for parts specified with wider operating temperature ranges. *The temperature grade is identified by a label on the shipping container.

For more information on lead free part marking, go to: <http://www.linear.com/leadfree/>

For more information on tape and reel specifications, go to: <http://www.linear.com/tapeandreeel/>

3758afd

ELECTRICAL CHARACTERISTICS The ● denotes the specifications which apply over the full operating temperature range, otherwise specifications are at $T_A = 25^\circ\text{C}$. $V_{IN} = 24\text{V}$, $\overline{\text{SHDN}}/\text{UVLO} = 24\text{V}$, $\text{SENSE} = 0\text{V}$, unless otherwise noted.

PARAMETER	CONDITIONS		MIN	TYP	MAX	UNITS
V_{IN} Operating Range			5.5		100	V
V_{IN} Shutdown I_Q	$\overline{\text{SHDN}}/\text{UVLO} = 0\text{V}$ $\overline{\text{SHDN}}/\text{UVLO} = 1.15\text{V}$			0.1	1 6	μA μA
V_{IN} Operating I_Q	$V_C = 0.3\text{V}$, $R_T = 41.2\text{k}$			1.75	2.2	mA
V_{IN} Operating I_Q with Internal LDO Disabled	$V_C = 0.3\text{V}$, $R_T = 41.2\text{k}$, $\text{INTV}_{\text{CC}} = 7.5\text{V}$			350	400	μA
SENSE Current Limit Threshold		●	100	110	120	mV
SENSE Input Bias Current	Current Out of Pin			-65		μA
Error Amplifier						
FBX Regulation Voltage ($V_{\text{FBX(REG)}}$)	FBX > 0V (Note 3) FBX < 0V (Note 3)	● ●	1.569 -0.816	1.6 -0.800	1.631 -0.784	V V
FBX Overvoltage Lockout	FBX > 0V (Note 4) FBX < 0V (Note 4)		6 7	8 11	10 14	% %
FBX Pin Input Current	FBX = 1.6V (Note 3) FBX = -0.8V (Note 3)		-10	70	100 10	nA nA
Transconductance g_m ($\Delta I_{V_C}/\Delta \text{FBX}$)	(Note 3)			230		μS
V_C Output Impedance	(Note 3)			5		$\text{M}\Omega$
V_{FBX} Line Regulation ($\Delta V_{\text{FBX}}/[\Delta V_{IN} \cdot V_{\text{FBX(REG)}}]$)	FBX > 0V, $5.5\text{V} < V_{IN} < 100\text{V}$ (Notes 3, 6) FBX < 0V, $5.5\text{V} < V_{IN} < 100\text{V}$ (Notes 3, 6)			0.006 0.005	0.025 0.03	%/V %/V
V_C Current Mode Gain ($\Delta V_{V_C}/\Delta V_{\text{SENSE}}$)				5.5		V/V
V_C Source Current	$V_C = 1.5\text{V}$			-15		μA
V_C Sink Current	FBX = 1.7V FBX = -0.85V			12 11		μA μA
Oscillator						
Switching Frequency	$R_T = 41.2\text{k}$ to GND, FBX = 1.6V $R_T = 140\text{k}$ to GND, FBX = 1.6V $R_T = 10.5\text{k}$ to GND, FBX = 1.6V		270	300 100 1000	330	kHz kHz kHz
RT Voltage	FBX = 1.6V			1.2		V
Minimum Off-Time				220		ns
Minimum On-Time				220		ns
SYNC Input Low					0.4	
SYNC Input High			1.5			
SS Pull-Up Current	SS = 0V, Current Out of Pin			-10		μA
Low Dropout Regulator						
INTV_{CC} Regulation Voltage		●	7	7.2	7.4	V
INTV_{CC} Undervoltage Lockout Threshold	Falling INTV_{CC} UVLO Hysteresis		4.3	4.5 0.5	4.7	V V
INTV_{CC} Overvoltage Lockout Threshold				17.5		V
INTV_{CC} Current Limit	$V_{IN} = 100\text{V}$ $V_{IN} = 20\text{V}$		11	16 50	22	mA mA
INTV_{CC} Load Regulation ($\Delta V_{\text{INTVCC}}/V_{\text{INTVCC}}$)	$0 < I_{\text{INTVCC}} < 10\text{mA}$, $V_{IN} = 8\text{V}$		-1	-0.4		%
INTV_{CC} Line Regulation ($\Delta V_{\text{INTVCC}}/[\Delta V_{IN} \cdot V_{\text{INTVCC}}]$)	$8\text{V} < V_{IN} < 100\text{V}$			0.005	0.02	%/V
Dropout Voltage ($V_{IN} - V_{\text{INTVCC}}$)	$V_{IN} = 6\text{V}$, $I_{\text{INTVCC}} = 10\text{mA}$			500		mV

LT3758/LT3758A

ELECTRICAL CHARACTERISTICS

The ● denotes the specifications which apply over the full operating temperature range, otherwise specifications are at $T_A = 25^\circ\text{C}$. $V_{IN} = 24\text{V}$, $\overline{\text{SHDN}}/\text{UVLO} = 24\text{V}$, $\text{SENSE} = 0\text{V}$, unless otherwise noted.

PARAMETER	CONDITIONS	MIN	TYP	MAX	UNITS
INTV _{CC} Current in Shutdown	$\overline{\text{SHDN}}/\text{UVLO} = 0\text{V}$, INTV _{CC} = 8V		16		μA
INTV _{CC} Voltage to Bypass Internal LDO				7.5	V
Logic Inputs					
$\overline{\text{SHDN}}/\text{UVLO}$ Threshold Voltage Falling	$V_{IN} = \text{INTV}_{CC} = 8\text{V}$	● 1.17	1.22	1.27	V
$\overline{\text{SHDN}}/\text{UVLO}$ Input Low Voltage	I_{VIN} Drops Below 1μA			0.4	V
$\overline{\text{SHDN}}/\text{UVLO}$ Pin Bias Current Low	$\overline{\text{SHDN}}/\text{UVLO} = 1.15\text{V}$	1.7	2	2.5	μA
$\overline{\text{SHDN}}/\text{UVLO}$ Pin Bias Current High	$\overline{\text{SHDN}}/\text{UVLO} = 1.33\text{V}$		10	100	nA
Gate Driver					
t _r Gate Driver Output Rise Time	$C_L = 3300\text{pF}$ (Note 5), INTV _{CC} = 7.5V		22		ns
t _f Gate Driver Output Fall Time	$C_L = 3300\text{pF}$ (Note 5), INTV _{CC} = 7.5V		20		ns
Gate Output Low (V _{OL})				0.05	V
Gate Output High (V _{OH})		INTV _{CC} -0.05			V

Note 1: Stresses beyond those listed under Absolute Maximum Ratings may cause permanent damage to the device. Exposure to any Absolute Maximum Rating condition for extended periods may affect device reliability and lifetime.

Note 2: The LT3758E/LT3758AE are guaranteed to meet performance specifications from the 0°C to 125°C junction temperature. Specifications over the -40°C to 125°C operating junction temperature range are assured by design, characterization and correlation with statistical process controls. The LT3758I/LT3758AI are guaranteed over the full -40°C to 125°C operating junction temperature range. The LT3758H/LT3758AH are guaranteed over the full -40°C to 150°C operating junction temperature range. High junction temperatures degrade operating lifetimes. Operating lifetime is derated at junction temperatures greater than 125°C. The LT3758MP/LT3758AMP are 100% tested and guaranteed over the full -55°C to 150°C operating junction temperature range.

Note 3: The LT3758/LT3758A are tested in a feedback loop which servos V_{FBX} to the reference voltages (1.6V and -0.8V) with the V_C pin forced to 1.3V.

Note 4: FBX overvoltage lockout is measured at $V_{FBX(\text{OVERVOLTAGE})}$ relative to regulated $V_{FBX(\text{REG})}$.

Note 5: Rise and fall times are measured at 10% and 90% levels.

Note 6: $\overline{\text{SHDN}}/\text{UVLO} = 1.33\text{V}$ when $V_{IN} = 5.5\text{V}$.

Note 7: For V_{IN} below 6V, the $\overline{\text{SHDN}}/\text{UVLO}$ pin must not exceed V_{IN} .

Note 8: The LT3758/LT3758A include overtemperature protection that is intended to protect the device during momentary overload conditions. Junction temperature will exceed the maximum operating junction temperature when overtemperature protection is active. Continuous operation above the specified maximum operating junction temperature may impair device reliability.

TYPICAL PERFORMANCE CHARACTERISTICS $T_A = 25^\circ\text{C}$, unless otherwise noted.

Positive Feedback Voltage vs Temperature, V_{IN}

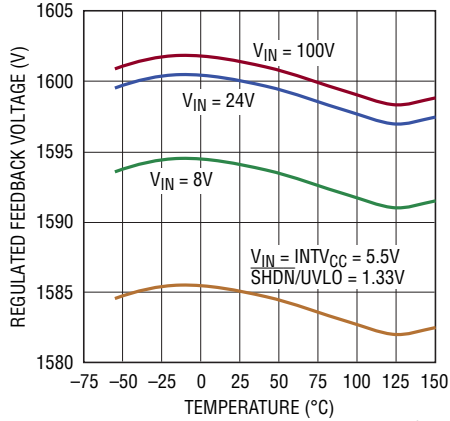

Negative Feedback Voltage vs Temperature, V_{IN}

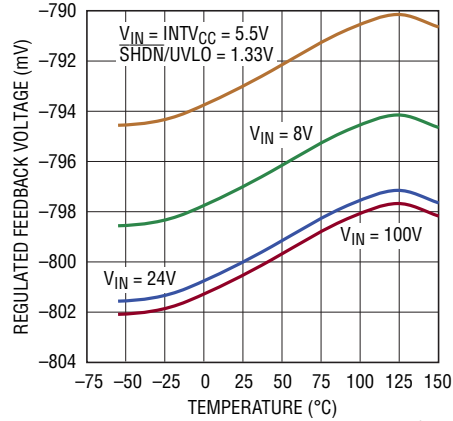

Quiescent Current vs Temperature, V_{IN}

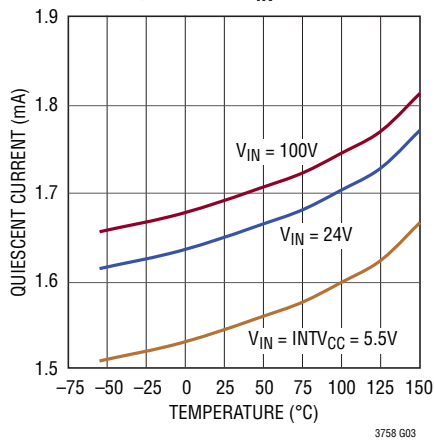

Dynamic Quiescent Current vs Switching Frequency

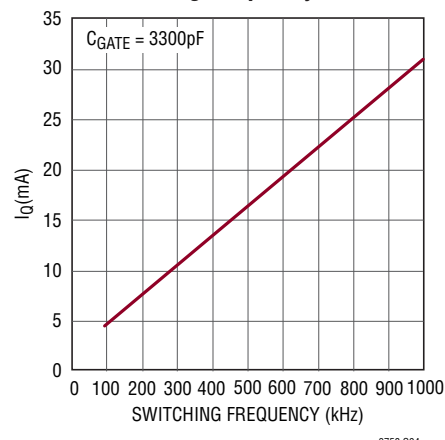

R_T vs Switching Frequency

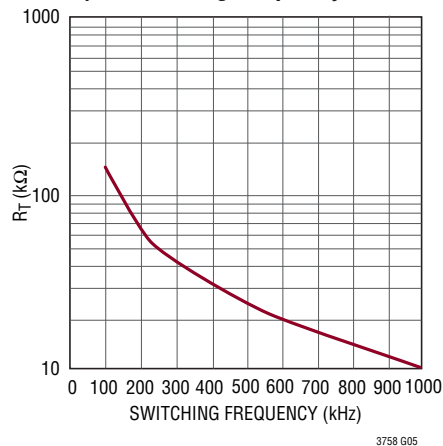

Normalized Switching Frequency vs FBX

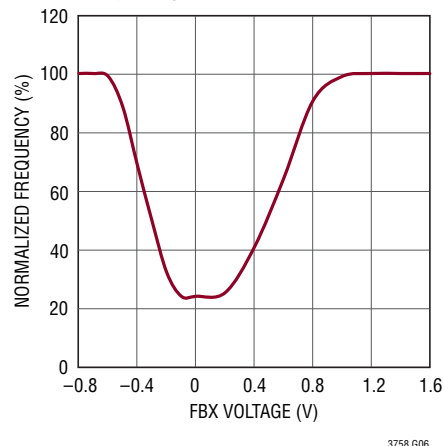

TYPICAL PERFORMANCE CHARACTERISTICS $T_A = 25^\circ\text{C}$, unless otherwise noted.

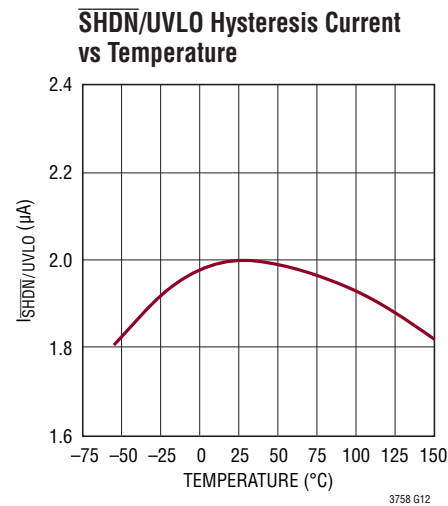
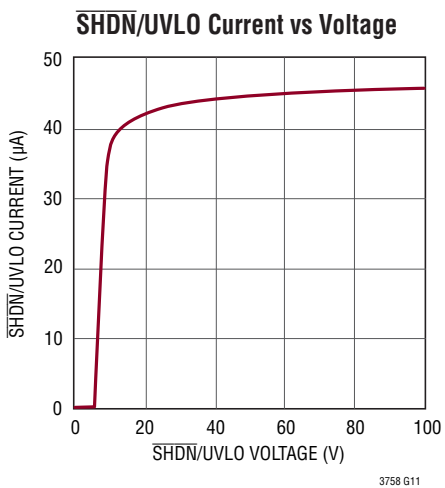
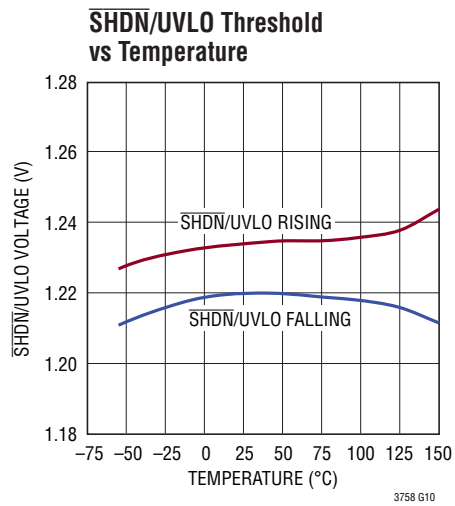
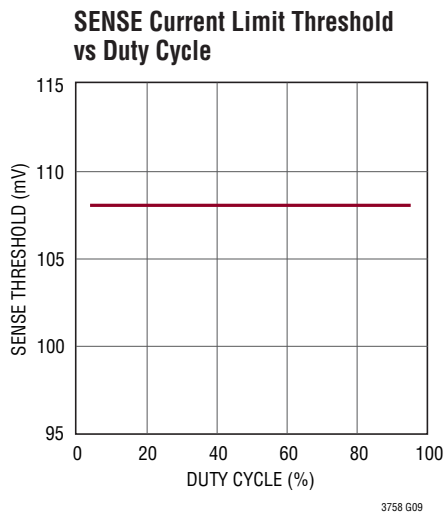
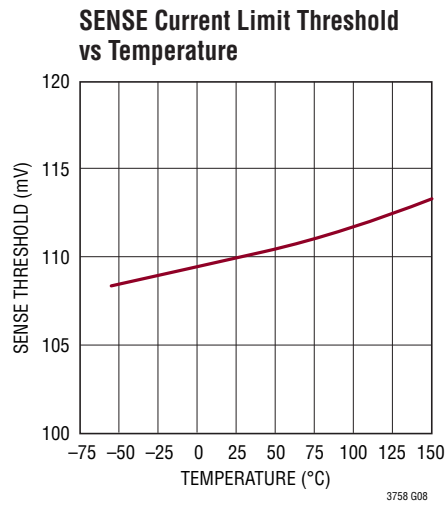
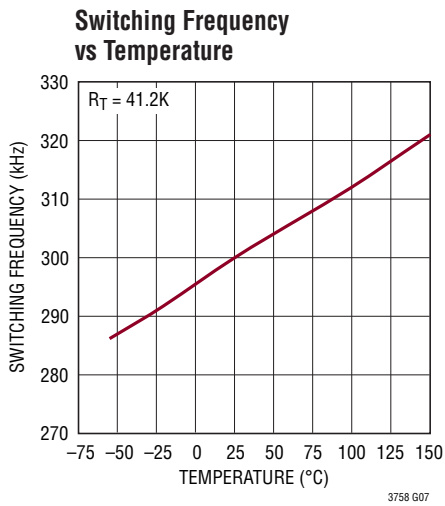

TYPICAL PERFORMANCE CHARACTERISTICS $T_A = 25^\circ\text{C}$, unless otherwise noted.

INTV_{CC} vs Temperature

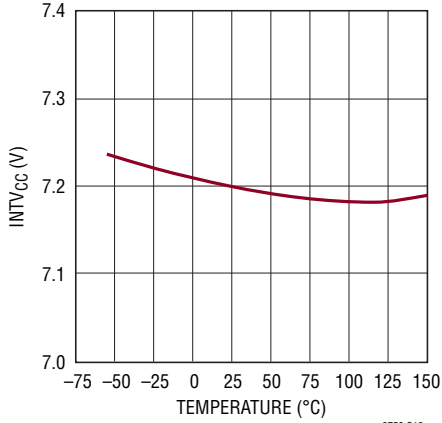

INTV_{CC} Minimum Output Current vs V_{IN}

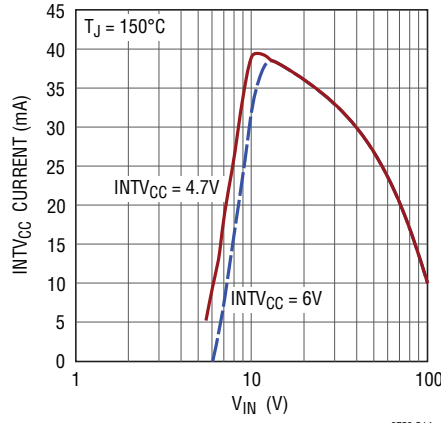

INTV_{CC} Load Regulation

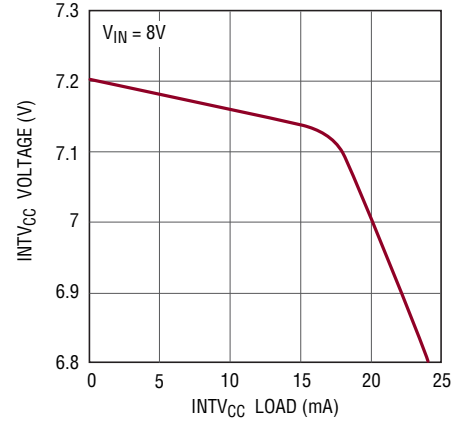

INTV_{CC} Line Regulation

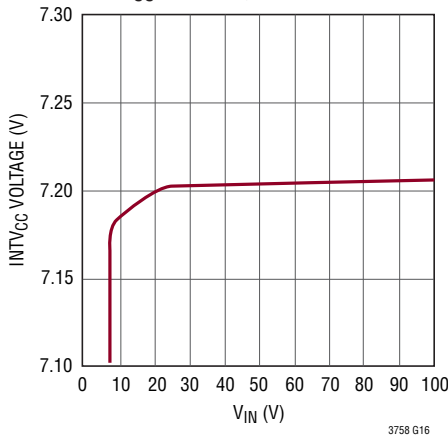

INTV_{CC} Dropout Voltage vs Current, Temperature

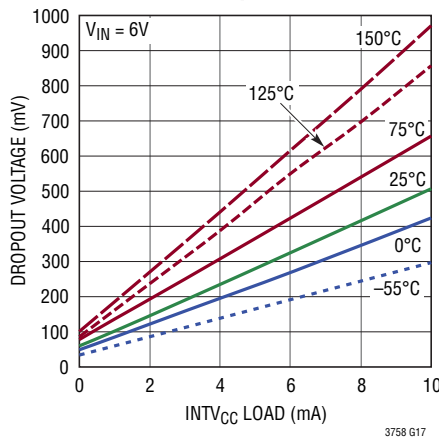

Gate Drive Rise and Fall Time vs C_L

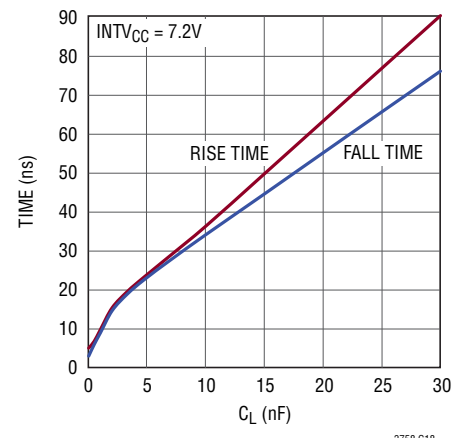

Gate Drive Rise and Fall Time vs INTV_{CC}

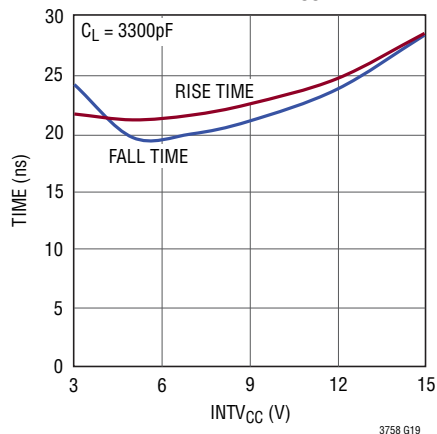

Typical Start-Up Waveforms

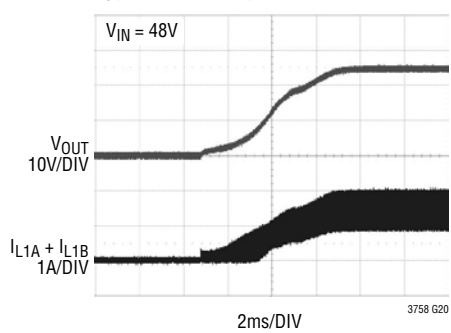

SEE TYPICAL APPLICATION: 18V TO 72V INPUT, 24V OUTPUT SEPIC CONVERTER

FBX Frequency Foldback Waveforms During Overcurrent

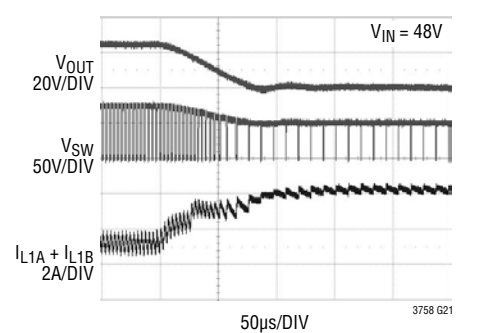

SEE TYPICAL APPLICATION: 18V TO 72V INPUT, 24V OUTPUT SEPIC CONVERTER

PIN FUNCTIONS

V_C (Pin 1): Error Amplifier Compensation Pin. Used to stabilize the voltage loop with an external RC network.

FBX (Pin 2): Positive and Negative Feedback Pin. Receives the feedback voltage from the external resistor divider across the output. Also modulates the switching frequency during start-up and fault conditions when FBX is close to GND.

SS (Pin 3): Soft-Start Pin. This pin modulates compensation pin voltage (V_C) clamp. The soft-start interval is set with an external capacitor. The pin has a 10μA (typical) pull-up current source to an internal 2.5V rail. The soft-start pin is reset to GND by an undervoltage condition at $\overline{\text{SHDN}}$ /UVLO, an INTV_{CC} undervoltage or overvoltage condition or an internal thermal lockout.

RT (Pin 4): Switching Frequency Adjustment Pin. Set the frequency using a resistor to GND. Do not leave this pin open.

SYNC (Pin 5): Frequency Synchronization Pin. Used to synchronize the switching frequency to an outside clock. If this feature is used, an R_T resistor should be chosen to program a switching frequency 20% slower than the SYNC pulse frequency. Tie the SYNC pin to GND if this feature is not used. SYNC is bypassed when FBX is close to GND.

SENSE (Pin 6): The Current Sense Input for the Control Loop. Kelvin connect this pin to the positive terminal of the switch current sense resistor in the source of the NFET. The negative terminal of the current sense resistor should be connected to GND plane close to the IC.

GATE (Pin 7): N-Channel MOSFET Gate Driver Output. Switches between INTV_{CC} and GND. Driven to GND when IC is shut down, during thermal lockout or when INTV_{CC} is above or below the overvoltage or UV thresholds, respectively.

INTV_{CC} (Pin 8): Regulated Supply for Internal Loads and Gate Driver. Supplied from V_{IN} and regulated to 7.2V (typical). INTV_{CC} must be bypassed with a minimum of 4.7μF capacitor placed close to pin. INTV_{CC} can be connected directly to V_{IN}, if V_{IN} is less than 17.5V. INTV_{CC} can also be connected to a power supply whose voltage is higher than 7.5V, and lower than V_{IN}, provided that supply does not exceed 17.5V.

$\overline{\text{SHDN}}$ /UVLO (Pin 9): Shutdown and Undervoltage Detect Pin. An accurate 1.22V (nominal) falling threshold with externally programmable hysteresis detects when power is okay to enable switching. Rising hysteresis is generated by the external resistor divider and an accurate internal 2μA pull-down current. An undervoltage condition resets sort-start. Tie to 0.4V, or less, to disable the device and reduce V_{IN} quiescent current below 1μA.

V_{IN} (Pin 10): Input Supply Pin. Must be locally bypassed with a 0.22μF, or larger, capacitor placed close to the pin.

Exposed Pad (Pin 11): Ground. This pin also serves as the negative terminal of the current sense resistor. The exposed pad must be soldered directly to the local ground plane.

BLOCK DIAGRAM

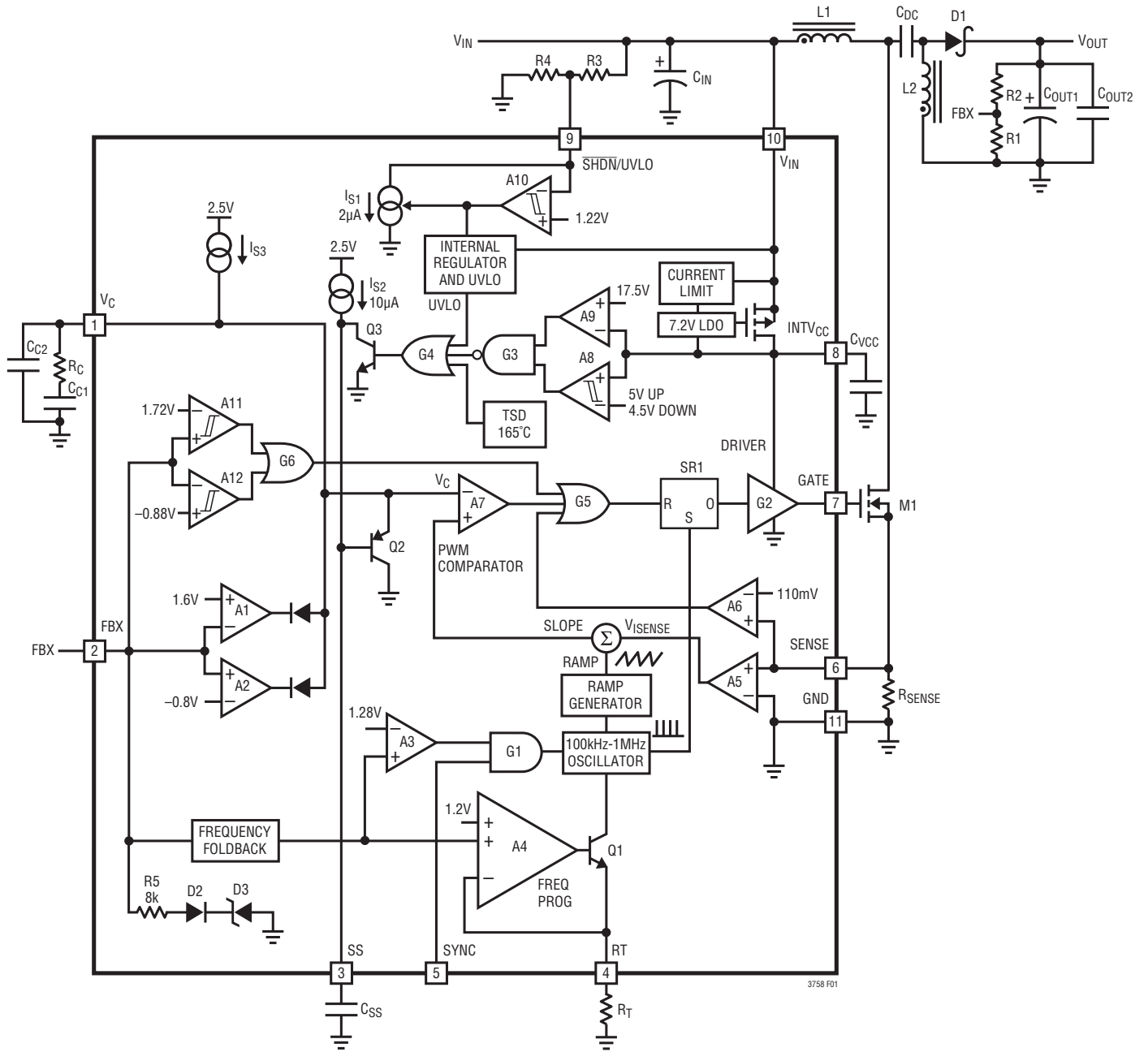

Figure 1. LT3758 Block Diagram Working as a SEPIC Converter

APPLICATIONS INFORMATION

Main Control Loop

The LT3758 uses a fixed frequency, current mode control scheme to provide excellent line and load regulation. Operation can be best understood by referring to the Block Diagram in Figure 1.

The start of each oscillator cycle sets the SR latch (SR1) and turns on the external power MOSFET switch M1 through driver G2. The switch current flows through the external current sensing resistor R_{SENSE} and generates a voltage proportional to the switch current. This current sense voltage V_{ISENSE} (amplified by A5) is added to a stabilizing slope compensation ramp and the resulting sum (SLOPE) is fed into the positive terminal of the PWM comparator A7. When SLOPE exceeds the level at the negative input of A7 (V_C pin), SR1 is reset, turning off the power switch. The level at the negative input of A7 is set by the error amplifier A1 (or A2) and is an amplified version of the difference between the feedback voltage (FBX pin) and the reference voltage (1.6V or $-0.8V$, depending on the configuration). In this manner, the error amplifier sets the correct peak switch current level to keep the output in regulation.

The LT3758 has a switch current limit function. The current sense voltage is input to the current limit comparator A6. If the SENSE pin voltage is higher than the sense current limit threshold $V_{SENSE(MAX)}$ (110mV, typical), A6 will reset SR1 and turn off M1 immediately.

The LT3758 is capable of generating either positive or negative output voltage with a single FBX pin. It can be configured as a boost, flyback or SEPIC converter to generate positive output voltage, or as an inverting converter to generate negative output voltage. When configured as a SEPIC converter, as shown in Figure 1, the FBX pin is pulled up to the internal bias voltage of 1.6V by a voltage divider (R1 and R2) connected from V_{OUT} to GND. Comparator A2 becomes inactive and comparator A1 performs the inverting amplification from FBX to V_C . When the LT3758 is in an inverting configuration, the FBX pin is pulled down to $-0.8V$ by a voltage divider connected from V_{OUT} to GND. Comparator A1 becomes inactive and comparator A2 performs the noninverting amplification from FBX to V_C .

The LT3758 has overvoltage protection functions to protect the converter from excessive output voltage overshoot during start-up or recovery from a short-circuit condition. An overvoltage comparator A11 (with 20mV hysteresis) senses when the FBX pin voltage exceeds the positive regulated voltage (1.6V) by 8% and provides a reset pulse. Similarly, an overvoltage comparator A12 (with 10mV hysteresis) senses when the FBX pin voltage exceeds the negative regulated voltage ($-0.8V$) by 11% and provides a reset pulse. Both reset pulses are sent to the main RS latch (SR1) through G6 and G5. The power MOSFET switch M1 is actively held off for the duration of an output overvoltage condition.

Programming Turn-On and Turn-Off Thresholds with the $\overline{SHDN}/UVLO$ Pin

The $\overline{SHDN}/UVLO$ pin controls whether the LT3758 is enabled or is in shutdown state. A micropower 1.22V reference, a comparator A10 and a controllable current source I_{S1} allow the user to accurately program the supply voltage at which the IC turns on and off. The falling value can be accurately set by the resistor dividers R3 and R4. When $\overline{SHDN}/UVLO$ is above 0.4V, and below the 1.22V threshold, the small pull-down current source I_{S1} (typical 2 μA) is active.

The purpose of this current is to allow the user to program the rising hysteresis. The Block Diagram of the comparator and the external resistors is shown in Figure 1. The typical falling threshold voltage and rising threshold voltage can be calculated by the following equations:

$$V_{VIN,FALLING} = 1.22 \cdot \frac{(R3 + R4)}{R4}$$

$$V_{VIN,RISING} = 2\mu A \cdot R3 + V_{IN,FALLING}$$

For applications where the $\overline{SHDN}/UVLO$ pin is only used as a logic input, the $\overline{SHDN}/UVLO$ pin can be connected directly to the input voltage V_{IN} through a 1k resistor for always-on operation.

APPLICATIONS INFORMATION

INTV_{CC} Regulator Bypassing and Operation

An internal, low dropout (LDO) voltage regulator produces the 7.2V INTV_{CC} supply which powers the gate driver, as shown in Figure 1. The LT3758 contains an undervoltage lockout comparator A8 and an overvoltage lockout comparator A9 for the INTV_{CC} supply. The INTV_{CC} undervoltage (UV) threshold is 4.5V (typical), with 0.5V hysteresis, to ensure that the MOSFETs have sufficient gate drive voltage before turning on. The logic circuitry within the LT3758 is also powered from the internal INTV_{CC} supply.

The INTV_{CC} overvoltage threshold is set to be 17.5V (typical) to protect the gate of the power MOSFET. When INTV_{CC} is below the UV threshold, or above the overvoltage threshold, the GATE pin will be forced to GND and the soft-start operation will be triggered.

The INTV_{CC} regulator must be bypassed to ground immediately adjacent to the IC pins with a minimum of 4.7μF ceramic capacitor. Good bypassing is necessary to supply the high transient currents required by the MOSFET gate driver.

In an actual application, most of the IC supply current is used to drive the gate capacitance of the power MOSFET. The on-chip power dissipation can be a significant concern when a large power MOSFET is being driven at a high frequency and the V_{IN} voltage is high. It is important to limit the power dissipation through selection of MOSFET and/or operating frequency so the LT3758 does not exceed its maximum junction temperature rating. The junction temperature T_J can be estimated using the following equations:

$$T_J = T_A + P_{IC} \cdot \theta_{JA}$$

T_A = ambient temperature

θ_{JA} = junction-to-ambient thermal resistance

P_{IC} = IC power consumption

$$= V_{IN} \cdot (I_Q + I_{DRIVE})$$

I_Q = V_{IN} operation I_Q = 1.6mA

I_{DRIVE} = average gate drive current = f • Q_G

f = switching frequency

Q_G = power MOSFET total gate charge

The LT3758 uses packages with an Exposed Pad for enhanced thermal conduction. With proper soldering to the Exposed Pad on the underside of the package and a full copper plane underneath the device, thermal resistance (θ_{JA}) will be about 43°C/W for the DD package and 40°C/W for the MSE package. For an ambient board temperature of T_A = 70°C and maximum junction temperature of 125°C, the maximum I_{DRIVE} (I_{DRIVE(MAX)}) of the DD package can be calculated as:

$$I_{DRIVE(MAX)} = \frac{(T_J - T_A)}{(\theta_{JA} \cdot V_{IN})} - I_Q = \frac{1.28W}{V_{IN}} - 1.6mA$$

The LT3758 has an internal INTV_{CC} I_{DRIVE} current limit function to protect the IC from excessive on-chip power dissipation. The I_{DRIVE} current limit decreases as the V_{IN} increases (see the INTV_{CC} Minimum Output Current vs V_{IN} graph in the Typical Performance Characteristics section). If I_{DRIVE} reaches the current limit, INTV_{CC} voltage will fall and may trigger the soft-start.

Based on the preceding equation and the INTV_{CC} Minimum Output Current vs V_{IN} graph, the user can calculate the maximum MOSFET gate charge the LT3758 can drive at a given V_{IN} and switch frequency. A plot of the maximum Q_G vs V_{IN} at different frequencies to guarantee a minimum 4.7V INTV_{CC} is shown in Figure 2.

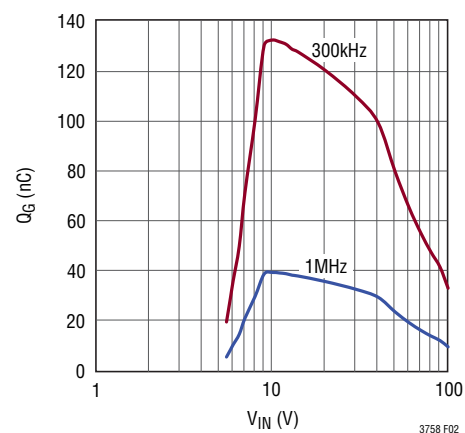

Figure 2. Recommended Maximum Q_G vs V_{IN} at Different Frequencies to Ensure INTV_{CC} Higher Than 4.7V

APPLICATIONS INFORMATION

As illustrated in Figure 2, a trade-off between the operating frequency and the size of the power MOSFET may be needed in order to maintain a reliable IC junction temperature. Prior to lowering the operating frequency, however, be sure to check with power MOSFET manufacturers for their most recent low Q_G , low $R_{DS(ON)}$ devices. Power MOSFET manufacturing technologies are continually improving, with newer and better performance devices being introduced almost yearly.

An effective approach to reduce the power consumption of the internal LDO for gate drive is to tie the $INTV_{CC}$ pin to an external voltage source high enough to turn off the internal LDO regulator.

If the input voltage V_{IN} does not exceed the absolute maximum rating of both the power MOSFET gate-source voltage (V_{GS}) and the $INTV_{CC}$ overvoltage lockout threshold voltage (17.5V), the $INTV_{CC}$ pin can be shorted directly to the V_{IN} pin. In this condition, the internal LDO will be turned off and the gate driver will be powered directly from the input voltage V_{IN} . With the $INTV_{CC}$ pin shorted to V_{IN} , however, a small current (around 16 μ A) will load the $INTV_{CC}$ in shutdown mode. For applications that require the lowest shutdown mode input supply current, do not connect the $INTV_{CC}$ pin to V_{IN} .

In SEPIC or flyback applications, the $INTV_{CC}$ pin can be connected to the output voltage V_{OUT} through a blocking diode, as shown in Figure 3, if V_{OUT} meets the following conditions:

1. $V_{OUT} < V_{IN}$ (pin voltage)
2. $V_{OUT} < 17.5V$
3. $V_{OUT} < \text{maximum } V_{GS} \text{ rating of power MOSFET}$

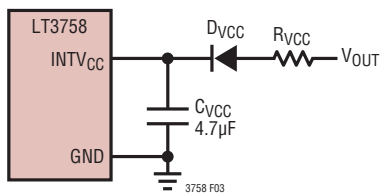

Figure 3. Connecting $INTV_{CC}$ to V_{OUT}

A resistor R_{VCC} can be connected, as shown in Figure 3, to limit the inrush current from V_{OUT} . Regardless of whether or not the $INTV_{CC}$ pin is connected to an external voltage source, it is always necessary to have the driver circuitry bypassed with a 4.7 μ F low ESR ceramic capacitor to ground immediately adjacent to the $INTV_{CC}$ and GND pins.

Operating Frequency and Synchronization

The choice of operating frequency may be determined by on-chip power dissipation, otherwise it is a trade-off between efficiency and component size. Low frequency operation improves efficiency by reducing gate drive current and MOSFET and diode switching losses. However, lower frequency operation requires a physically larger inductor. Switching frequency also has implications for loop compensation. The LT3758 uses a constant-frequency architecture that can be programmed over a 100kHz to 1000kHz range with a single external resistor from the R_T pin to ground, as shown in Figure 1. The R_T pin must have an external resistor to GND for proper operation of the LT3758. A table for selecting the value of R_T for a given operating frequency is shown in Table 1.

Table 1. Timing Resistor (R_T) Value

SWITCHING FREQUENCY (kHz)	R_T (k Ω)
100	140
200	63.4
300	41.2
400	30.9
500	24.3
600	19.6
700	16.5
800	14
900	12.1
1000	10.5

The operating frequency of the LT3758 can be synchronized to an external clock source. By providing a digital clock signal into the SYNC pin, the LT3758 will operate at the SYNC clock frequency. If this feature is used, an R_T resistor should be chosen to program a switching frequency 20% slower than SYNC pulse frequency. It is recommended the SYNC pulse have a minimum pulse width of 200ns. Tie the SYNC pin to GND if this feature is not used.

APPLICATIONS INFORMATION

Duty Cycle Consideration

Switching duty cycle is a key variable defining converter operation. As such, its limits must be considered. Minimum on-time is the smallest time duration that the LT3758 is capable of turning on the power MOSFET. This time is generally about 220ns (typical) (see Minimum On-Time in the Electrical Characteristics table). In each switching cycle, the LT3758 keeps the power switch off for at least 220ns (typical) (see Minimum Off-Time in the Electrical Characteristics table).

The minimum on-time and minimum off-time and the switching frequency define the minimum and maximum switching duty cycles a converter is able to generate:

Minimum duty cycle = minimum on-time • frequency

Maximum duty cycle = 1 – (minimum off-time • frequency)

Programming the Output Voltage

The output voltage V_{OUT} is set by a resistor divider, as shown in Figure 1. The positive and negative V_{OUT} are set by the following equations:

$$V_{OUT, POSITIVE} = 1.6V \cdot \left(1 + \frac{R2}{R1}\right)$$

$$V_{OUT, NEGATIVE} = -0.8V \cdot \left(1 + \frac{R2}{R1}\right)$$

The resistors R1 and R2 are typically chosen so that the error caused by the current flowing into the FBX pin during normal operation is less than 1% (this translates to a maximum value of R1 at about 158k).

In the applications where V_{OUT} is pulled up by an external positive power supply, the FBX pin is also pulled up through the R2 and R1 network. Make sure the FBX does not exceed its absolute maximum rating (6V). The R5, D2, and D3 in Figure 1 provide a resistive clamp in the positive direction. To ensure FBX is lower than 6V, choose sufficiently large R1 and R2 to meet the following condition:

$$6V \cdot \left(1 + \frac{R2}{R1}\right) + 3.5V \cdot \frac{R2}{8k\Omega} > V_{OUT(MAX)}$$

where $V_{OUT(MAX)}$ is the maximum V_{OUT} that is pulled up by an external power supply.

Soft-Start

The LT3758 contains several features to limit peak switch currents and output voltage (V_{OUT}) overshoot during start-up or recovery from a fault condition. The primary purpose of these features is to prevent damage to external components or the load.

High peak switch currents during start-up may occur in switching regulators. Since V_{OUT} is far from its final value, the feedback loop is saturated and the regulator tries to charge the output capacitor as quickly as possible, resulting in large peak currents. A large surge current may cause inductor saturation or power switch failure.

The LT3758 addresses this mechanism with the SS pin. As shown in Figure 1, the SS pin reduces the power MOSFET current by pulling down the V_C pin through Q2. In this way the SS allows the output capacitor to charge gradually toward its final value while limiting the start-up peak currents. The typical start-up waveforms are shown in the Typical Performance Characteristics section. The inductor current I_L slewing rate is limited by the soft-start function.

Besides start-up (with $\overline{SHDN}/UVLO$), soft-start can also be triggered by the following faults:

1. $INTV_{CC} > 17.5V$
2. $INTV_{CC} < 4.5V$
3. Thermal lockout

Any of these three faults will cause the LT3758 to stop switching immediately. The SS pin will be discharged by Q3. When all faults are cleared and the SS pin has been discharged below 0.2V, a 10 μ A current source I_{S2} starts charging the SS pin, initiating a soft-start operation.

The soft-start interval is set by the soft-start capacitor selection according to the equation:

$$T_{SS} = C_{SS} \cdot \frac{1.25V}{10\mu A}$$

APPLICATIONS INFORMATION

FBX Frequency Foldback

When V_{OUT} is very low during start-up or a GND fault on the output, the switching regulator must operate at low duty cycles to maintain the power switch current within the current limit range, since the inductor current decay rate is very low during switch off time. The minimum on-time limitation may prevent the switcher from attaining a sufficiently low duty cycle at the programmed switching frequency. So, the switch current will keep increasing through each switch cycle, exceeding the programmed current limit. To prevent the switch peak currents from exceeding the programmed value, the LT3758 contains a frequency foldback function to reduce the switching frequency when the FBX voltage is low (see the Normalized Switching Frequency vs FBX graph in the Typical Performance Characteristics section).

During frequency foldback, external clock synchronization is disabled to prevent interference with frequency reducing operation.

Thermal Lockout

If LT3758 die temperature reaches 165°C (typical), the part will go into thermal lockout. The power switch will be turned off. A soft-start operation will be triggered. The part will be enabled again when the die temperature has dropped by 5°C (nominal).

Loop Compensation

Loop compensation determines the stability and transient performance. The LT3758/LT3758A use current mode control to regulate the output which simplifies loop compensation. The LT3758A improves the no-load to heavy

load transient response, when compared to the LT3758. New internal circuits ensure that the transient from not switching to switching at high current can be made in a few cycles. The optimum values depend on the converter topology, the component values and the operating conditions (including the input voltage, load current, etc.). To compensate the feedback loop of the LT3758/LT3758A, a series resistor-capacitor network is usually connected from the V_C pin to GND. Figure 1 shows the typical V_C compensation network. For most applications, the capacitor should be in the range of 470pF to 22nF, and the resistor should be in the range of 5k to 50k. A small capacitor is often connected in parallel with the RC compensation network to attenuate the V_C voltage ripple induced from the output voltage ripple through the internal error amplifier. The parallel capacitor usually ranges in value from 10pF to 100pF. A practical approach to design the compensation network is to start with one of the circuits in this data sheet that is similar to your application, and tune the compensation network to optimize the performance. Stability should then be checked across all operating conditions, including load current, input voltage and temperature.

SENSE Pin Programming

For control and protection, the LT3758 measures the power MOSFET current by using a sense resistor (R_{SENSE}) between GND and the MOSFET source. Figure 4 shows a typical waveform of the sense voltage (V_{SENSE}) across the sense resistor. It is important to use Kelvin traces between the SENSE pin and R_{SENSE} , and to place the IC GND as close as possible to the GND terminal of the R_{SENSE} for proper operation.

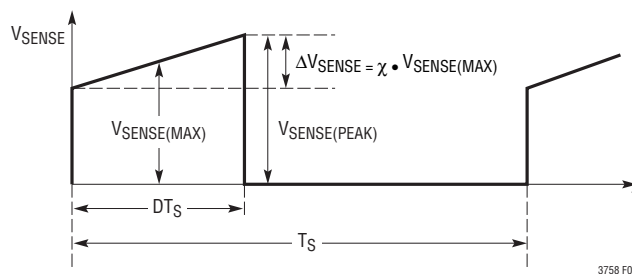

Figure 4. The Sense Voltage During a Switching Cycle

APPLICATIONS INFORMATION

Due to the current limit function of the SENSE pin, R_{SENSE} should be selected to guarantee that the peak current sense voltage $V_{\text{SENSE(PEAK)}}$ during steady state normal operation is lower than the SENSE current limit threshold (see the Electrical Characteristics table). Given a 20% margin, $V_{\text{SENSE(PEAK)}}$ is set to be 80mV. Then, the maximum switch ripple current percentage can be calculated using the following equation:

$$\chi = \frac{\Delta V_{\text{SENSE}}}{80\text{mV} - 0.5 \cdot \Delta V_{\text{SENSE}}}$$

χ is used in subsequent design examples to calculate inductor value. ΔV_{SENSE} is the ripple voltage across R_{SENSE} .

The LT3758 switching controller incorporates 100ns timing interval to blank the ringing on the current sense signal immediately after M1 is turned on. This ringing is caused by the parasitic inductance and capacitance of the PCB trace, the sense resistor, the diode, and the MOSFET. The 100ns timing interval is adequate for most of the LT3758 applications. In the applications that have very large and long ringing on the current sense signal, a small RC filter can be added to filter out the excess ringing. Figure 5 shows the RC filter on the SENSE pin. It is usually sufficient to choose 22Ω for R_{FLT} and 2.2nF to 10nF for C_{FLT} . Keep R_{FLT} 's resistance low. Remember that there is $65\mu\text{A}$ (typical) flowing out of the SENSE pin. Adding R_{FLT} will affect the SENSE current limit threshold:

$$V_{\text{SENSE_ILIM}} = 110\text{mV} - 65\mu\text{A} \cdot R_{\text{FLT}}$$

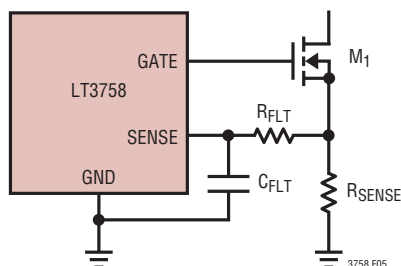

Figure 5. The RC Filter on the SENSE Pin

APPLICATION CIRCUITS

The LT3758 can be configured as different topologies. The first topology to be analyzed will be the boost converter, followed by the flyback, SEPIC and inverting converters.

Boost Converter: Switch Duty Cycle and Frequency

The LT3758 can be configured as a boost converter for the applications where the converter output voltage is higher than the input voltage. Remember that boost converters are not short-circuit protected. Under a shorted output condition, the inductor current is limited only by the input supply capability. For applications requiring a step-up converter that is short-circuit protected, please refer to the Applications Information section covering SEPIC converters.

The conversion ratio as a function of duty cycle is:

$$\frac{V_{\text{OUT}}}{V_{\text{IN}}} = \frac{1}{1-D}$$

in continuous conduction mode (CCM).

For a boost converter operating in CCM, the duty cycle of the main switch can be calculated based on the output voltage (V_{OUT}) and the input voltage (V_{IN}). The maximum duty cycle (D_{MAX}) occurs when the converter has the minimum input voltage:

$$D_{\text{MAX}} = \frac{V_{\text{OUT}} - V_{\text{IN(MIN)}}}{V_{\text{OUT}}}$$

Discontinuous conduction mode (DCM) provides higher conversion ratios at a given frequency at the cost of reduced efficiencies and higher switching currents.

Boost Converter: Inductor and Sense Resistor Selection

For the boost topology, the maximum average inductor current is:

$$I_{\text{L(MAX)}} = I_{\text{O(MAX)}} \cdot \frac{1}{1-D_{\text{MAX}}}$$

Then, the ripple current can be calculated by:

$$\Delta I_{\text{L}} = \chi \cdot I_{\text{L(MAX)}} = \chi \cdot I_{\text{O(MAX)}} \cdot \frac{1}{1-D_{\text{MAX}}}$$

APPLICATIONS INFORMATION

The constant χ in the preceding equation represents the percentage peak-to-peak ripple current in the inductor, relative to $I_{L(MAX)}$.

The inductor ripple current has a direct effect on the choice of the inductor value. Choosing smaller values of ΔI_L requires large inductances and reduces the current loop gain (the converter will approach voltage mode). Accepting larger values of ΔI_L provides fast transient response and allows the use of low inductances, but results in higher input current ripple and greater core losses. It is recommended that χ fall within the range of 0.2 to 0.6.

Given an operating input voltage range, and having chosen the operating frequency and ripple current in the inductor, the inductor value of the boost converter can be determined using the following equation:

$$L = \frac{V_{IN(MIN)}}{\Delta I_L \cdot f} \cdot D_{MAX}$$

The peak and RMS inductor current are:

$$I_{L(PEAK)} = I_{L(MAX)} \cdot \left(1 + \frac{\chi}{2}\right)$$

$$I_{L(RMS)} = I_{L(MAX)} \cdot \sqrt{1 + \frac{\chi^2}{12}}$$

Based on these equations, the user should choose the inductors having sufficient saturation and RMS current ratings.

Set the sense voltage at $I_{L(PEAK)}$ to be the minimum of the SENSE current limit threshold with a 20% margin. The sense resistor value can then be calculated to be:

$$R_{SENSE} = \frac{80mV}{I_{L(PEAK)}}$$

Boost Converter: Power MOSFET Selection

Important parameters for the power MOSFET include the drain-source voltage rating (V_{DS}), the threshold voltage ($V_{GS(TH)}$), the on-resistance ($R_{DS(ON)}$), the gate to source and gate to drain charges (Q_{GS} and Q_{GD}), the maximum drain current ($I_{D(MAX)}$) and the MOSFET's thermal resistances ($R_{\theta JC}$ and $R_{\theta JA}$).

The power MOSFET will see full output voltage, plus a diode forward voltage, and any additional ringing across its drain-to-source during its off-time. It is recommended to choose a MOSFET whose B_{VDSS} is higher than V_{OUT} by a safety margin (a 10V safety margin is usually sufficient).

The power dissipated by the MOSFET in a boost converter is:

$$P_{FET} = I_{L(MAX)}^2 \cdot R_{DS(ON)} \cdot D_{MAX} + 2 \cdot V_{OUT} \cdot I_{L(MAX)} \cdot C_{RSS} \cdot f/1A$$

The first term in the preceding equation represents the conduction losses in the device, and the second term, the switching loss. C_{RSS} is the reverse transfer capacitance, which is usually specified in the MOSFET characteristics.

For maximum efficiency, $R_{DS(ON)}$ and C_{RSS} should be minimized. From a known power dissipated in the power MOSFET, its junction temperature can be obtained using the following equation:

$$T_J = T_A + P_{FET} \cdot \theta_{JA} = T_A + P_{FET} \cdot (\theta_{JC} + \theta_{CA})$$

T_J must not exceed the MOSFET maximum junction temperature rating. It is recommended to measure the MOSFET temperature in steady state to ensure that absolute maximum ratings are not exceeded.

Boost Converter: Output Diode Selection

To maximize efficiency, a fast switching diode with low forward drop and low reverse leakage is desirable. The peak reverse voltage that the diode must withstand is equal to the regulator output voltage plus any additional ringing across its anode-to-cathode during the on-time. The average forward current in normal operation is equal to the output current, and the peak current is equal to:

$$I_{D(PEAK)} = I_{L(PEAK)} = \left(1 + \frac{\chi}{2}\right) \cdot I_{L(MAX)}$$

It is recommended that the peak repetitive reverse voltage rating V_{RRM} is higher than V_{OUT} by a safety margin (a 10V safety margin is usually sufficient).

The power dissipated by the diode is:

$$P_D = I_{O(MAX)} \cdot V_D$$

and the diode junction temperature is:

$$T_J = T_A + P_D \cdot R_{\theta JA}$$

APPLICATIONS INFORMATION

The $R_{\theta JA}$ to be used in this equation normally includes the $R_{\theta JC}$ for the device plus the thermal resistance from the board to the ambient temperature in the enclosure. T_J must not exceed the diode maximum junction temperature rating.

Boost Converter: Output Capacitor Selection

Contributions of ESR (equivalent series resistance), ESL (equivalent series inductance) and the bulk capacitance must be considered when choosing the correct output capacitors for a given output ripple voltage. The effect of these three parameters (ESR, ESL and bulk C) on the output voltage ripple waveform for a typical boost converter is illustrated in Figure 6.

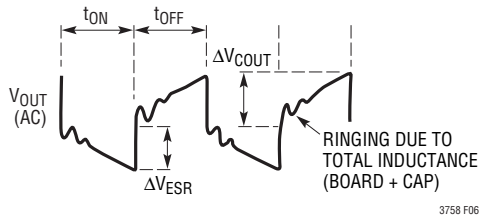

Figure 6. The Output Ripple Waveform of a Boost Converter

The choice of component(s) begins with the maximum acceptable ripple voltage (expressed as a percentage of the output voltage), and how this ripple should be divided between the ESR step ΔV_{ESR} and the charging/discharging ΔV_{COUT} . For the purpose of simplicity, we will choose 2% for the maximum output ripple, to be divided equally between ΔV_{ESR} and ΔV_{COUT} . This percentage ripple will change, depending on the requirements of the application, and the following equations can easily be modified. For a 1% contribution to the total ripple voltage, the ESR of the output capacitor can be determined using the following equation:

$$ESR_{COUT} \leq \frac{0.01 \cdot V_{OUT}}{I_{D(PEAK)}}$$

For the bulk C component, which also contributes 1% to the total ripple:

$$C_{OUT} \geq \frac{I_{O(MAX)}}{0.01 \cdot V_{OUT} \cdot f}$$

The output capacitor in a boost regulator experiences high RMS ripple currents, as shown in Figure 6. The RMS ripple current rating of the output capacitor can be determined using the following equation:

$$I_{RMS(COUT)} \geq I_{O(MAX)} \cdot \sqrt{\frac{D_{MAX}}{1-D_{MAX}}}$$

Multiple capacitors are often paralleled to meet ESR requirements. Typically, once the ESR requirement is satisfied, the capacitance is adequate for filtering and has the required RMS current rating. Additional ceramic capacitors in parallel are commonly used to reduce the effect of parasitic inductance in the output capacitor, which reduces high frequency switching noise on the converter output.

Boost Converter: Input Capacitor Selection

The input capacitor of a boost converter is less critical than the output capacitor, due to the fact that the inductor is in series with the input, and the input current waveform is continuous. The input voltage source impedance determines the size of the input capacitor, which is typically in the range of $10\mu F$ to $100\mu F$. A low ESR capacitor is recommended, although it is not as critical as for the output capacitor.

The RMS input capacitor ripple current for a boost converter is:

$$I_{RMS(CIN)} = 0.3 \cdot \Delta I_L$$

FLYBACK CONVERTER APPLICATIONS

The LT3758 can be configured as a flyback converter for the applications where the converters have multiple outputs, high output voltages or isolated outputs. Figure 7 shows a simplified flyback converter.

The flyback converter has a very low parts count for multiple outputs, and with prudent selection of turns ratio, can have high output/input voltage conversion ratios with a desirable duty cycle. However, it has low efficiency due to the high peak currents, high peak voltages and consequent power loss. The flyback converter is commonly used for an output power of less than 50W.

APPLICATIONS INFORMATION

The flyback converter can be designed to operate either in continuous or discontinuous mode. Compared to continuous mode, discontinuous mode has the advantage of smaller transformer inductances and easy loop compensation, and the disadvantage of higher peak-to-average current and lower efficiency.

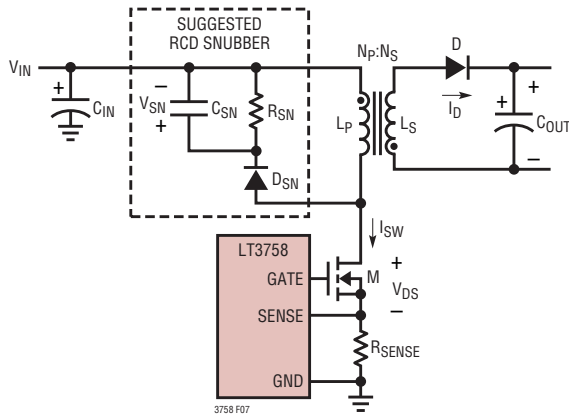

Figure 7. A Simplified Flyback Converter

Flyback Converter: Switch Duty Cycle and Turns Ratio

The flyback converter conversion ratio in the continuous mode operation is:

$$\frac{V_{OUT}}{V_{IN}} = \frac{N_S}{N_P} \cdot \frac{D}{1-D}$$

Where N_S/N_P is the second to primary turns ratio.

Figure 8 shows the waveforms of the flyback converter in discontinuous mode operation. During each switching period T_S , three subintervals occur: DT_S , $D2T_S$, $D3T_S$. During DT_S , M is on, and D is reverse-biased. During $D2T_S$, M is off, and L_S is conducting current. Both L_P and L_S currents are zero during $D3T_S$.

The flyback converter conversion ratio in the discontinuous mode operation is:

$$\frac{V_{OUT}}{V_{IN}} = \frac{N_S}{N_P} \cdot \frac{D}{D2}$$

According to the preceding equations, the user has relative freedom in selecting the switch duty cycle or turns ratio to suit a given application. The selections of the duty cycle and the turns ratio are somewhat iterative processes, due

to the number of variables involved. The user can choose either a duty cycle or a turns ratio as the start point. The following trade-offs should be considered when selecting the switch duty cycle or turns ratio, to optimize the converter performance. A higher duty cycle affects the flyback converter in the following aspects:

- Lower MOSFET RMS current $I_{SW(RMS)}$, but higher MOSFET V_{DS} peak voltage
- Lower diode peak reverse voltage, but higher diode RMS current $I_{D(RMS)}$
- Higher transformer turns ratio (N_P/N_S)

The choice,

$$\frac{D}{D+D2} = \frac{1}{3}$$

(for discontinuous mode operation with a given $D3$) gives the power MOSFET the lowest power stress (the product of RMS current and peak voltage). The choice,

$$\frac{D}{D+D2} = \frac{2}{3}$$

(for discontinuous mode operation with a given $D3$) gives the diode the lowest power stress (the product of RMS current and peak voltage). An extreme high or low duty cycle results in high power stress on the MOSFET or diode, and reduces efficiency. It is recommended to choose a duty cycle between 20% and 80%.

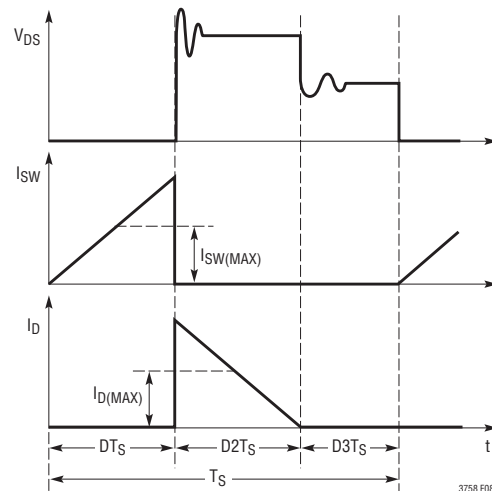

Figure 8. Waveforms of the Flyback Converter in Discontinuous Mode Operation

APPLICATIONS INFORMATION

Flyback Converter: Transformer Design for Discontinuous Mode Operation

The transformer design for discontinuous mode of operation is chosen as presented here. According to Figure 8, the minimum D3 ($D3_{MIN}$) occurs when the the converter has the minimum V_{IN} and the maximum output power (P_{OUT}). Choose $D3_{MIN}$ to be equal to or higher than 10% to guarantee the converter is always in discontinuous mode operation. Choosing higher D3 allows the use of low inductances but results in higher switch peak current. The user can choose a D_{MAX} as the start point. Then, the maximum average primary currents can be calculated by the following equation:

$$I_{LP(MAX)} = I_{SW(MAX)} = \frac{P_{OUT(MAX)}}{D_{MAX} \cdot V_{IN(MIN)} \cdot \eta}$$

where η is the converter efficiency.

If the flyback converter has multiple outputs, $P_{OUT(MAX)}$ is the sum of all the output power.

The maximum average secondary current is:

$$I_{LS(MAX)} = I_{D(MAX)} = \frac{I_{OUT(MAX)}}{D2}$$

where

$$D2 = 1 - D_{MAX} - D3$$

the primary and secondary RMS currents are:

$$I_{LP(RMS)} = 2 \cdot I_{LP(MAX)} \cdot \sqrt{\frac{D_{MAX}}{3}}$$

$$I_{LS(RMS)} = 2 \cdot I_{LS(MAX)} \cdot \sqrt{\frac{D2}{3}}$$

According to Figure 8, the primary and secondary peak currents are:

$$I_{LP(PEAK)} = I_{SW(PEAK)} = 2 \cdot I_{LP(MAX)}$$

$$I_{LS(PEAK)} = I_{D(PEAK)} = 2 \cdot I_{LS(MAX)}$$

The primary and second inductor values of the flyback converter transformer can be determined using the following equations:

$$L_P = \frac{D_{MAX}^2 \cdot V_{IN(MIN)}^2 \cdot \eta}{2 \cdot P_{OUT(MAX)} \cdot f}$$

$$L_S = \frac{D2^2 \cdot (V_{OUT} + V_D)}{2 \cdot I_{OUT(MAX)} \cdot f}$$

The primary to second turns ratio is:

$$\frac{N_P}{N_S} = \sqrt{\frac{L_P}{L_S}}$$

Flyback Converter: Snubber Design

Transformer leakage inductance (on either the primary or secondary) causes a voltage spike to occur after the MOSFET turn-off. This is increasingly prominent at higher load currents, where more stored energy must be dissipated. In some cases a snubber circuit will be required to avoid overvoltage breakdown at the MOSFET's drain node. There are different snubber circuits, and Application Note 19 is a good reference on snubber design. An RCD snubber is shown in Figure 7.

The snubber resistor value (R_{SN}) can be calculated by the following equation:

$$R_{SN} = 2 \cdot \frac{V_{SN}^2 - V_{SN} \cdot V_{OUT} \cdot \frac{N_P}{N_S}}{I_{SW(PEAK)}^2 \cdot L_{LK} \cdot f}$$

where V_{SN} is the snubber capacitor voltage. A smaller V_{SN} results in a larger snubber loss. A reasonable V_{SN} is 2 to 2.5 times of:

$$\frac{V_{OUT} \cdot N_P}{N_S}$$

APPLICATIONS INFORMATION

L_{LK} is the leakage inductance of the primary winding, which is usually specified in the transformer characteristics. L_{LK} can be obtained by measuring the primary inductance with the secondary windings shorted. The snubber capacitor value (C_{CN}) can be determined using the following equation:

$$C_{CN} = \frac{V_{SN}}{\Delta V_{SN} \cdot R_{CN} \cdot f}$$

where ΔV_{SN} is the voltage ripple across C_{CN} . A reasonable ΔV_{SN} is 5% to 10% of V_{SN} . The reverse voltage rating of D_{SN} should be higher than the sum of V_{SN} and $V_{IN(MAX)}$.

Flyback Converter: Sense Resistor Selection

In a flyback converter, when the power switch is turned on, the current flowing through the sense resistor (I_{SENSE}) is:

$$I_{SENSE} = I_{LP}$$

Set the sense voltage at $I_{LP(PEAK)}$ to be the minimum of the SENSE current limit threshold with a 20% margin. The sense resistor value can then be calculated to be:

$$R_{SENSE} = \frac{80mV}{I_{LP(PEAK)}}$$

Flyback Converter: Power MOSFET Selection

For the flyback configuration, the MOSFET is selected with a V_{DC} rating high enough to handle the maximum V_{IN} , the reflected secondary voltage and the voltage spike due to the leakage inductance. Approximate the required MOSFET V_{DC} rating using:

$$BV_{DSS} > V_{DS(PEAK)}$$

where

$$V_{DS(PEAK)} = V_{IN(MAX)} + V_{SN}$$

The power dissipated by the MOSFET in a flyback converter is:

$$P_{FET} = I_{M(RMS)}^2 \cdot R_{DS(ON)} + 2 \cdot V_{DS(PEAK)}^2 \cdot I_{L(MAX)} \cdot C_{RSS} \cdot f / A$$

The first term in this equation represents the conduction losses in the device, and the second term, the switching loss. C_{RSS} is the reverse transfer capacitance, which is usually specified in the MOSFET characteristics.

From a known power dissipated in the power MOSFET, its junction temperature can be obtained using the following equation:

$$T_J = T_A + P_{FET} \cdot \theta_{JA} = T_A + P_{FET} \cdot (\theta_{JC} + \theta_{CA})$$

T_J must not exceed the MOSFET maximum junction temperature rating. It is recommended to measure the MOSFET temperature in steady state to ensure that absolute maximum ratings are not exceeded.

Flyback Converter: Output Diode Selection

The output diode in a flyback converter is subject to large RMS current and peak reverse voltage stresses. A fast switching diode with a low forward drop and a low reverse leakage is desired. Schottky diodes are recommended if the output voltage is below 100V.

Approximate the required peak repetitive reverse voltage rating V_{RRM} using:

$$V_{RRM} > \frac{N_S}{N_P} \cdot V_{IN(MAX)} + V_{OUT}$$

The power dissipated by the diode is:

$$P_D = I_{O(MAX)} \cdot V_D$$

and the diode junction temperature is:

$$T_J = T_A + P_D \cdot R_{\theta JA}$$

The $R_{\theta JA}$ to be used in this equation normally includes the $R_{\theta JC}$ for the device, plus the thermal resistance from the board to the ambient temperature in the enclosure. T_J must not exceed the diode maximum junction temperature rating.

Flyback Converter: Output Capacitor Selection

The output capacitor of the flyback converter has a similar operation condition as that of the boost converter. Refer to the Boost Converter: Output Capacitor Selection section for the calculation of C_{OUT} and ESR_{COUT} .

The RMS ripple current rating of the output capacitors in discontinuous operation can be determined using the following equation:

$$I_{RMS(COUT),DISCONTINUOUS} \geq I_{O(MAX)} \cdot \sqrt{\frac{4 - (3 \cdot D2)}{3 \cdot D2}}$$

APPLICATIONS INFORMATION

Flyback Converter: Input Capacitor Selection

The input capacitor in a flyback converter is subject to a large RMS current due to the discontinuous primary current. To prevent large voltage transients, use a low ESR input capacitor sized for the maximum RMS current. The RMS ripple current rating of the input capacitors in discontinuous operation can be determined using the following equation:

$$I_{\text{RMS(CIN),DISCONTINUOUS}} \geq \frac{P_{\text{OUT(MAX)}}}{V_{\text{IN(MIN)}} \cdot \eta} \cdot \sqrt{\frac{4 - (3 \cdot D_{\text{MAX}})}{3 \cdot D_{\text{MAX}}}}$$

SEPIC CONVERTER APPLICATIONS

The LT3758 can be configured as a SEPIC (single-ended primary inductance converter), as shown in Figure 1. This topology allows for the input to be higher, equal, or lower than the desired output voltage. The conversion ratio as a function of duty cycle is:

$$\frac{V_{\text{OUT}} + V_{\text{D}}}{V_{\text{IN}}} = \frac{D}{1 - D}$$

in continuous conduction mode (CCM).

In a SEPIC converter, no DC path exists between the input and output. This is an advantage over the boost converter for applications requiring the output to be disconnected from the input source when the circuit is in shutdown.

Compared to the flyback converter, the SEPIC converter has the advantage that both the power MOSFET and the output diode voltages are clamped by the capacitors (C_{IN} , C_{DC} and C_{OUT}), therefore, there is less voltage ringing across the power MOSFET and the output diodes. The SEPIC converter requires much smaller input capacitors than those of the flyback converter. This is due to the fact that, in the SEPIC converter, the inductor L1 is in series with the input, and the ripple current flowing through the input capacitor is continuous.

SEPIC Converter: Switch Duty Cycle and Frequency

For a SEPIC converter operating in CCM, the duty cycle of the main switch can be calculated based on the output voltage (V_{OUT}), the input voltage (V_{IN}) and the diode forward voltage (V_{D}).

The maximum duty cycle (D_{MAX}) occurs when the converter has the minimum input voltage:

$$D_{\text{MAX}} = \frac{V_{\text{OUT}} + V_{\text{D}}}{V_{\text{IN(MIN)}} + V_{\text{OUT}} + V_{\text{D}}}$$

SEPIC Converter: Inductor and Sense Resistor Selection

As shown in Figure 1, the SEPIC converter contains two inductors: L1 and L2. L1 and L2 can be independent, but can also be wound on the same core, since identical voltages are applied to L1 and L2 throughout the switching cycle.

For the SEPIC topology, the current through L1 is the converter input current. Based on the fact that, ideally, the output power is equal to the input power, the maximum average inductor currents of L1 and L2 are:

$$I_{\text{L1(MAX)}} = I_{\text{IN(MAX)}} = I_{\text{O(MAX)}} \cdot \frac{D_{\text{MAX}}}{1 - D_{\text{MAX}}}$$

$$I_{\text{L2(MAX)}} = I_{\text{O(MAX)}}$$

In a SEPIC converter, the switch current is equal to $I_{\text{L1}} + I_{\text{L2}}$ when the power switch is on, therefore, the maximum average switch current is defined as:

$$I_{\text{SW(MAX)}} = I_{\text{L1(MAX)}} + I_{\text{L2(MAX)}} = I_{\text{O(MAX)}} \cdot \frac{1}{1 - D_{\text{MAX}}}$$

and the peak switch current is:

$$I_{\text{SW(PEAK)}} = \left(1 + \frac{\chi}{2}\right) \cdot I_{\text{O(MAX)}} \cdot \frac{1}{1 - D_{\text{MAX}}}$$

The constant χ in the preceding equations represents the percentage peak-to-peak ripple current in the switch, relative to $I_{\text{SW(MAX)}}$, as shown in Figure 9. Then, the switch ripple current ΔI_{SW} can be calculated by:

$$\Delta I_{\text{SW}} = \chi \cdot I_{\text{SW(MAX)}}$$

The inductor ripple currents ΔI_{L1} and ΔI_{L2} are identical:

$$\Delta I_{\text{L1}} = \Delta I_{\text{L2}} = 0.5 \cdot \Delta I_{\text{SW}}$$

The inductor ripple current has a direct effect on the choice of the inductor value. Choosing smaller values of ΔI_{L} requires large inductances and reduces the current loop gain (the converter will approach voltage mode).

APPLICATIONS INFORMATION

Accepting larger values of ΔI_L allows the use of low inductances, but results in higher input current ripple and greater core losses. It is recommended that χ falls in the range of 0.2 to 0.6.

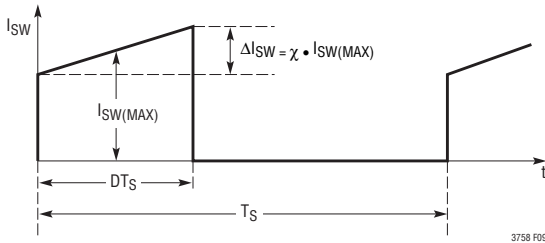

Figure 9. The Switch Current Waveform of the SEPIC Converter

Given an operating input voltage range, and having chosen the operating frequency and ripple current in the inductor, the inductor value (L1 and L2 are independent) of the SEPIC converter can be determined using the following equation:

$$L1=L2=\frac{V_{IN(MIN)}}{0.5 \cdot \Delta I_{SW} \cdot f} \cdot D_{MAX}$$

For most SEPIC applications, the equal inductor values will fall in the range of 1 μ H to 100 μ H.

By making L1 = L2, and winding them on the same core, the value of inductance in the preceding equation is replaced by 2L, due to mutual inductance:

$$L=\frac{V_{IN(MIN)}}{\Delta I_{SW} \cdot f} \cdot D_{MAX}$$

This maintains the same ripple current and energy storage in the inductors. The peak inductor currents are:

$$I_{L1(PEAK)}=I_{L1(MAX)}+0.5 \cdot \Delta I_{L1}$$

$$I_{L2(PEAK)}=I_{L2(MAX)}+0.5 \cdot \Delta I_{L2}$$

The RMS inductor currents are:

$$I_{L1(RMS)}=I_{L1(MAX)} \cdot \sqrt{1+\frac{\chi^2 L1}{12}}$$

where

$$\chi_{L1}=\frac{\Delta I_{L1}}{I_{L1(MAX)}}$$

$$I_{L2(RMS)}=I_{L2(MAX)} \cdot \sqrt{1+\frac{\chi^2 L2}{12}}$$

where

$$\chi_{L2}=\frac{\Delta I_{L2}}{I_{L2(MAX)}}$$

Based on the preceding equations, the user should choose the inductors having sufficient saturation and RMS current ratings.

In a SEPIC converter, when the power switch is turned on, the current flowing through the sense resistor (I_{SENSE}) is the switch current.

Set the sense voltage at $I_{SENSE(PEAK)}$ to be the minimum of the SENSE current limit threshold with a 20% margin. The sense resistor value can then be calculated to be:

$$R_{SENSE}=\frac{80 \text{ mV}}{I_{SW(PEAK)}}$$

SEPIC Converter: Power MOSFET Selection

For the SEPIC configuration, choose a MOSFET with a V_{DC} rating higher than the sum of the output voltage and input voltage by a safety margin (a 10V safety margin is usually sufficient).

The power dissipated by the MOSFET in a SEPIC converter is:

$$P_{FET}=I_{SW(MAX)}^2 \cdot R_{DS(ON)} \cdot D_{MAX}+2 \cdot (V_{IN(MIN)}+V_{OUT})^2 \cdot I_{L(MAX)} \cdot C_{RSS} \cdot f/1A$$

The first term in this equation represents the conduction losses in the device, and the second term, the switching loss. C_{RSS} is the reverse transfer capacitance, which is usually specified in the MOSFET characteristics.

For maximum efficiency, $R_{DS(ON)}$ and C_{RSS} should be minimized. From a known power dissipated in the power

APPLICATIONS INFORMATION

MOSFET, its junction temperature can be obtained using the following equation:

$$T_J = T_A + P_{FET} \cdot \theta_{JA} = T_A + P_{FET} \cdot (\theta_{JC} + \theta_{CA})$$

T_J must not exceed the MOSFET maximum junction temperature rating. It is recommended to measure the MOSFET temperature in steady state to ensure that absolute maximum ratings are not exceeded.

SEPIC Converter: Output Diode Selection

To maximize efficiency, a fast switching diode with a low forward drop and low reverse leakage is desirable. The average forward current in normal operation is equal to the output current, and the peak current is equal to:

$$I_{D(PEAK)} = \left(1 + \frac{\chi}{2}\right) \cdot I_{O(MAX)} \cdot \frac{1}{1 - D_{MAX}}$$

It is recommended that the peak repetitive reverse voltage rating V_{RRM} is higher than $V_{OUT} + V_{IN(MAX)}$ by a safety margin (a 10V safety margin is usually sufficient).

The power dissipated by the diode is:

$$P_D = I_{O(MAX)} \cdot V_D$$

and the diode junction temperature is:

$$T_J = T_A + P_D \cdot R_{\theta JA}$$

The $R_{\theta JA}$ used in this equation normally includes the $R_{\theta JC}$ for the device, plus the thermal resistance from the board, to the ambient temperature in the enclosure. T_J must not exceed the diode maximum junction temperature rating.

SEPIC Converter: Output and Input Capacitor Selection

The selections of the output and input capacitors of the SEPIC converter are similar to those of the boost converter. Please refer to the Boost Converter: Output Capacitor Selection and Boost Converter: Input Capacitor Selection sections.

SEPIC Converter: Selecting the DC Coupling Capacitor

The DC voltage rating of the DC coupling capacitor (C_{DC} , as shown in Figure 1) should be larger than the maximum input voltage:

$$V_{CDC} > V_{IN(MAX)}$$

C_{DC} has nearly a rectangular current waveform. During the switch off-time, the current through C_{DC} is I_{IN} , while approximately $-I_O$ flows during the on-time. The RMS rating of the coupling capacitor is determined by the following equation:

$$I_{RMS(CDC)} > I_{O(MAX)} \cdot \sqrt{\frac{V_{OUT} + V_D}{V_{IN(MIN)}}}$$

A low ESR and ESL, X5R or X7R ceramic capacitor works well for C_{DC} .

INVERTING CONVERTER APPLICATIONS

The LT3758 can be configured as a dual-inductor inverting topology, as shown in Figure 10. The V_{OUT} to V_{IN} ratio is:

$$\frac{V_{OUT} - V_D}{V_{IN}} = -\frac{D}{1 - D}$$

in continuous conduction mode (CCM).

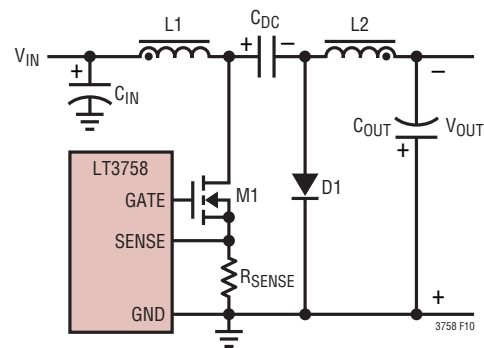

Figure 10. A Simplified Inverting Converter

Inverting Converter: Switch Duty Cycle and Frequency

For an inverting converter operating in CCM, the duty cycle of the main switch can be calculated based on the negative output voltage (V_{OUT}) and the input voltage (V_{IN}).

The maximum duty cycle (D_{MAX}) occurs when the converter has the minimum input voltage:

$$D_{MAX} = \frac{V_{OUT} - V_D}{V_{OUT} - V_D - V_{IN(MIN)}}$$

APPLICATIONS INFORMATION

Inverting Converter: Inductor, Sense Resistor, Power MOSFET, Output Diode and Input Capacitor Selections

The selections of the inductor, sense resistor, power MOSFET, output diode and input capacitor of an inverting converter are similar to those of the SEPIC converter. Please refer to the corresponding SEPIC converter sections.

Inverting Converter: Output Capacitor Selection

The inverting converter requires much smaller output capacitors than those of the boost, flyback and SEPIC converters for similar output ripples. This is due to the fact that, in the inverting converter, the inductor L2 is in series with the output, and the ripple current flowing through the output capacitors are continuous. The output ripple voltage is produced by the ripple current of L2 flowing through the ESR and bulk capacitance of the output capacitor:

$$\Delta V_{OUT(P-P)} = \Delta I_{L2} \cdot \left(ESR_{COUT} + \frac{1}{8 \cdot f \cdot C_{OUT}} \right)$$

After specifying the maximum output ripple, the user can select the output capacitors according to the preceding equation.

The ESR can be minimized by using high quality X5R or X7R dielectric ceramic capacitors. In many applications, ceramic capacitors are sufficient to limit the output voltage ripple.

The RMS ripple current rating of the output capacitor needs to be greater than:

$$I_{RMS(COUT)} > 0.3 \cdot \Delta I_{L2}$$

Inverting Converter: Selecting the DC Coupling Capacitor

The DC voltage rating of the DC coupling capacitor (C_{DC} , as shown in Figure 10) should be larger than the maximum input voltage minus the output voltage (negative voltage):

$$V_{CDC} > V_{IN(MAX)} - V_{OUT}$$

C_{DC} has nearly a rectangular current waveform. During the switch off-time, the current through C_{DC} is I_{IN} , while approximately $-I_O$ flows during the on-time. The RMS

rating of the coupling capacitor is determined by the following equation:

$$I_{RMS(CDC)} > I_{O(MAX)} \cdot \sqrt{\frac{D_{MAX}}{1-D_{MAX}}}$$

A low ESR and ESL, X5R or X7R ceramic capacitor works well for C_{DC} .

Board Layout

The high speed operation of the LT3758 demands careful attention to board layout and component placement. The Exposed Pad of the package is the only GND terminal of the IC, and is important for thermal management of the IC. Therefore, it is crucial to achieve a good electrical and thermal contact between the Exposed Pad and the ground plane of the board. For the LT3758 to deliver its full output power, it is imperative that a good thermal path be provided to dissipate the heat generated within the package. It is recommended that multiple vias in the printed circuit board be used to conduct heat away from the IC and into a copper plane with as much area as possible.

To prevent radiation and high frequency resonance problems, proper layout of the components connected to the IC is essential, especially the power paths with higher di/dt. The following high di/dt loops of different topologies should be kept as tight as possible to reduce inductive ringing:

- In boost configuration, the high di/dt loop contains the output capacitor, the sensing resistor, the power MOSFET and the Schottky diode.
- In flyback configuration, the high di/dt primary loop contains the input capacitor, the primary winding, the power MOSFET and the sensing resistor. The high di/dt secondary loop contains the output capacitor, the secondary winding and the output diode.
- In SEPIC configuration, the high di/dt loop contains the power MOSFET, sense resistor, output capacitor, Schottky diode and the coupling capacitor.
- In inverting configuration, the high di/dt loop contains power MOSFET, sense resistor, Schottky diode and the coupling capacitor.

APPLICATIONS INFORMATION

Check the stress on the power MOSFET by measuring its drain-to-source voltage directly across the device terminals (reference the ground of a single scope probe directly to the source pad on the PC board). Beware of inductive ringing, which can exceed the maximum specified voltage rating of the MOSFET. If this ringing cannot be avoided, and exceeds the maximum rating of the device, either choose a higher voltage device or specify an avalanche-rated power MOSFET.

The small-signal components should be placed away from high frequency switching nodes. For optimum load

regulation and true remote sensing, the top of the output voltage sensing resistor divider should connect independently to the top of the output capacitor (Kelvin connection), staying away from any high dV/dt traces. Place the divider resistors near the LT3758 in order to keep the high impedance FBX node short.

Figure 11 shows the suggested layout of the 10V to 40V input, 48V output boost converter in the Typical Applications section.

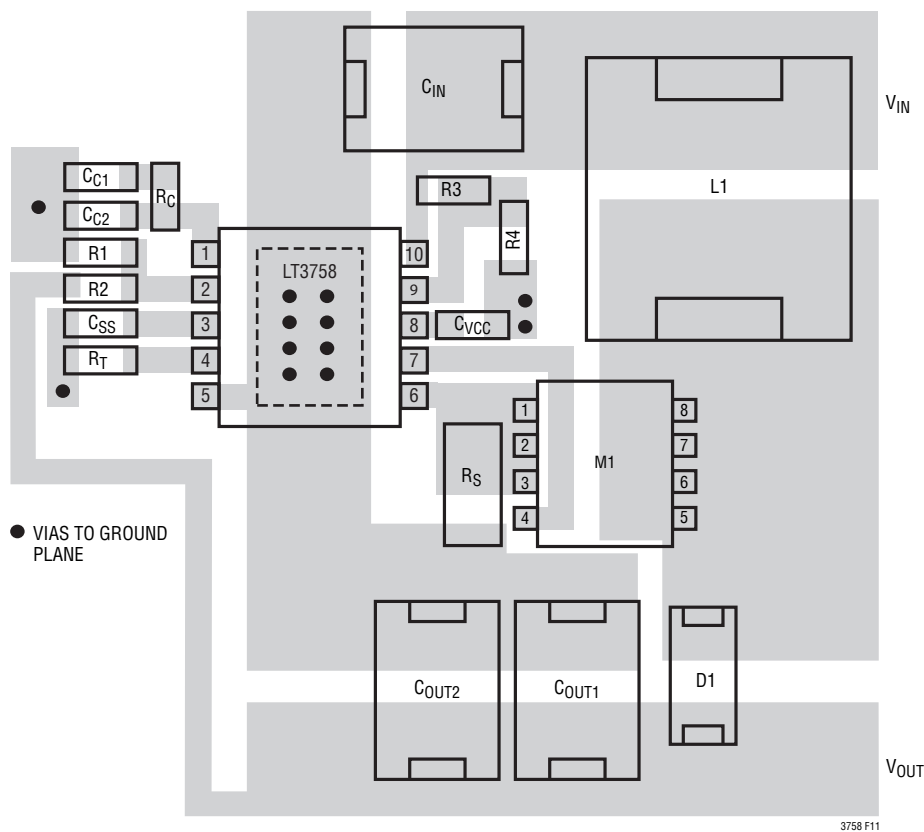

Figure 11. Suggested Layout of the 10V to 40V Input, 48V Output Boost Converter in the Typical Applications Section