



Chipsmall Limited consists of a professional team with an average of over 10 year of expertise in the distribution of electronic components. Based in Hongkong, we have already established firm and mutual-benefit business relationships with customers from,Europe,America and south Asia,supplying obsolete and hard-to-find components to meet their specific needs.

With the principle of “Quality Parts,Customers Priority,Honest Operation,and Considerate Service”,our business mainly focus on the distribution of electronic components. Line cards we deal with include Microchip,ALPS,ROHM,Xilinx,Pulse,ON,Everlight and Freescale. Main products comprise IC,Modules,Potentiometer,IC Socket,Relay,Connector.Our parts cover such applications as commercial,industrial, and automotives areas.

We are looking forward to setting up business relationship with you and hope to provide you with the best service and solution. Let us make a better world for our industry!



Contact us

Tel: +86-755-8981 8866 Fax: +86-755-8427 6832

Email & Skype: info@chipsmall.com Web: www.chipsmall.com

Address: A1208, Overseas Decoration Building, #122 Zhenhua RD., Futian, Shenzhen, China



LT4H Timers

UL File No.: E122222
C-UL File No.: E122222

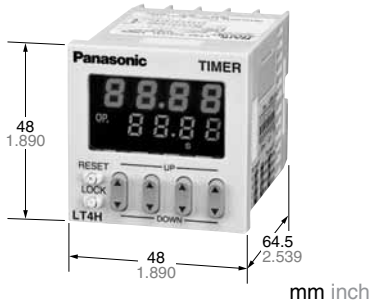

Pin type



Screw terminal type

Features

- Bright and Easy-to-Read Display**
A brand new bright 2-color back light LCD display. The easy-to-read screen in any location makes checking and setting procedures a cinch.
- Simple Operation**
Seesaw buttons make operating the unit even easier than before.
- Short Body of only 64.5 mm 2.539 inch (screw terminal type) or 70.1 mm 2.760 inch (pin type)**
With a short body, it is easy to install in even narrow control panels.
- Conforms to IP66's Weather Resistant Standards**
The water-proof panel keeps out water and dirt for reliable operation even in poor environments.

- Screw terminal (M3.5) and Pin Types are Both Standard Options**
The two terminal types are standard options to support either front panel installation or embedded installation.
- Changeable Panel Cover**
Also offers a black panel cover to meet your design considerations.
- Compliant with UL, c-UL and CE.**

RoHS Directive compatibility information
<http://www.nais-e.com/>

Product types

Time range	Operating mode	Output	Operating voltage	Power down insurance	Terminal type	Part number
9.999 s (0.001 s~) 99.99 s (0.01 s~) 999.9 s (0.1 s~) 9999 s (1 s~) 99 min 59 s (1 s~) 999.9 min (0.1 min~) 99 h 59 min (1 min~) 999.9 h (0.1 h~)	Power ON delay (1) Power ON delay (2) Signal ON delay Signal OFF delay Pulse One-shot Pulse ON-delay Signal Flicker Totalizing ON-delay (8 modes)	Relay (1 c)	100 to 240 V AC	Available	8 pins	LT4H8-AC240V
			24 V AC		11 pins	LT4H-AC240V
					Screw terminal	LT4H-AC240VS
			12 to 24 V DC		8 pins	LT4H8-AC24V
					11 pins	LT4H-AC24V
			Screw terminal		LT4H-AC24VS	
		Transistor (1 a)	100 to 240 V AC		8 pins	LT4HT8-AC240V
			24 V AC		11 pins	LT4HT-AC240V
					Screw terminal	LT4HT-AC240VS
			12 to 24 V DC		8 pins	LT4HT8-AC24V
					11 pins	LT4HT-AC24V
			Screw terminal		LT4HT-AC24VS	

* A rubber gasket (ATC18002) and a mounting frame (AT8-DA4) are included.

LT4H-L Timers

UL File No.: E122222
C-UL File No.: E122222



Features

- Economically priced in anticipation of market needs.**
 - Economically priced to provide excellent cost performance.
- Display is a bright reflective-type LCD.**
- Inherits all of the characteristics of the LT4H digital timer.**
 - Seesaw switches ensure easy operation.
 - IP66 environmental protection.
 - Shortened body (70.1 mm 2.760 inch underhead).

4. Compliant with UL, c-UL and CE.

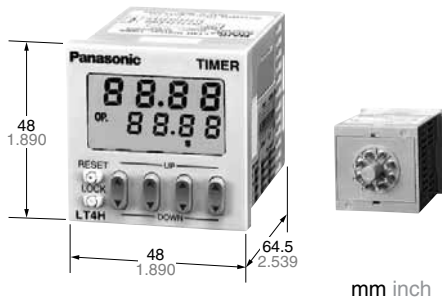

mm inch

Product types

Product name	Time range	Operating mode	Output	Operating voltage	Power down insurance	Terminal type	Part number
LT4H-L digital timer	9.999 s (0.001 s~) 99.99 s (0.01 s~) 999.9 s (0.1 s~) 9999 s (1 s~) 99 min 59 s (1 s~) 999.9 min (0.1 min~) 99 h 59 min (1 min~) 999.9 h (0.1 h~)	Power ON delay (1) Power ON delay (2) Signal ON delay Signal OFF delay Pulse One-shot Pulse ON-delay Signal Flicker Totalizing ON-delay (8 modes)	Relay (1 c)	100 to 240 V AC	Available	8 pins	LT4HL8-AC240V
				24 V AC/DC			LT4HL8-AC24V
				12 to 24 V DC			LT4HL8-DC24V
			Transistor (1 a)	100 to 240 V AC			LT4HLT8-AC240V
				24 V AC/DC			LT4HLT8-AC24V
				12 to 24 V DC			LT4HLT8-DC24V

Part names

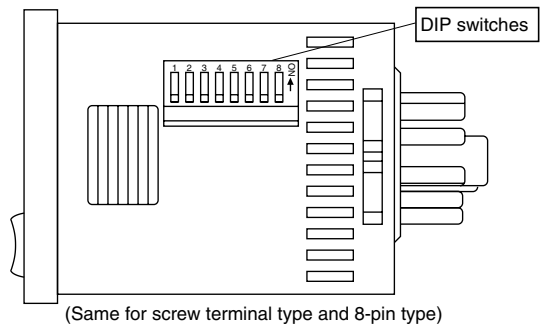
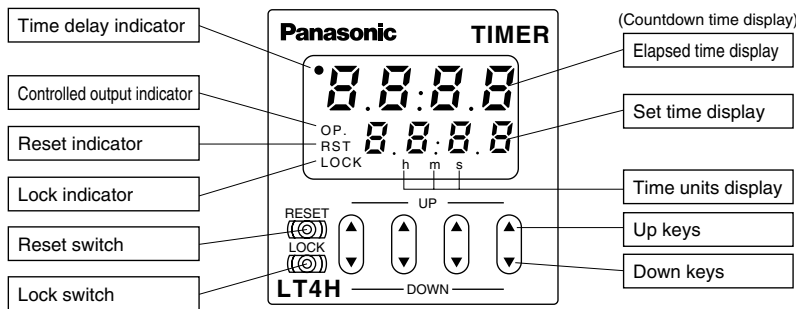

Specifications

Item	Type	Relay output type		Transistor output type	
		AC type AC/DC type	DC type	AC type AC/DC type	DC type
Rating	Rated operating voltage	100 to 240 V AC, 24 V AC, 24 V AC/DC	12 to 24 V DC	100 to 240 V AC, 24 V AC, 24 V AC/DC	12 to 24 V DC
	Rated frequency	50/60 Hz common	—	50/60 Hz common	—
	Rated power consumption	Max. 10 V A	Max. 3 W	Max. 10 V A	Max. 3 W
	Rated control capacity	5 A, 250 V AC (resistive load)		100 mA, 30 V DC	
	Time range	9.999 s, 99.99 s, 999.9 s, 9999 s, 99 min 59 s, 999.9 min, 99 h 59 min, 999.9 h (selected by DIP switch)			
	Time counting direction	Addition (UP)/Subtraction (DOWN) (2 directions selectable by DIP switch)			
	Operation mode	A (Power ON delay 1), A2 (Power ON delay 2), B (Signal ON delay), C (Signal OFF delay), D (Pulse one-shot), E (Pulse ON delay), F (Signal Flicker), G (Totalizing ON delay) (selectable by DIP switch)			
	Start/Reset/Stop input	Min. input signal width: 1 ms, 20 ms (2 directions by selected by DIP switch) (The 8-pin type does not have a stop input.)			
	Lock input	Min. input signal width: 20 ms (The 8-pin type does not have a lock input.)			
	Input signal	Open collector input Input impedance: Max. 1 kΩ; Residual voltage: Max. 2 V Open impedance: 100kΩ or less, Max. energized voltage: 40V DC			
	Indication	7-segment LCD (LT4H, LT4H-L common), Elapsed value (backlight red LED), Setting value (backlight yellow LED)			
Power failure memory method	EEP-ROM (Min. 10 ⁵ overwriting)				
Time accuracy (max.)	Operating time fluctuation	± (0.005 % + 50 ms) in case of power on start ± (0.005 % + 20 ms) in case of input signal start		[Operating voltage: 85 to 110% Temperature: -10 to +55°C +14 to +131°F Min. input signal width: 1ms]	
	Temperature error				
	Voltage error				
	Setting error				
Contact	Contact arrangement	Timed-out 1 Form C	Timed-out 1 Form A (Open collector)		
	Contact resistance (Initial value)	100 mΩ (at 1 A 6 V DC)	—		
	Contact material	Ag alloy/Au flash	—		
Life	Mechanical (contact)	Min. 2 × 10 ⁷ ope. (Except for switch operation parts)		—	
	Electrical (contact)	1.0 × 10 ⁵ ope. (At rated control voltage)		Min. 10 ⁷ ope. (At rated control voltage)	
Electrical	Allowable operating voltage range	85 to 110 % of rated operating voltage			
	Breakdown voltage (Initial value)	2,000 Vrms for 1 min: Between live and dead metal parts (11-pin) 2,000 Vrms for 1 min: Between input and output 1,000 Vrms for 1 min: Between contacts		2,000 Vrms for 1 min: Between live and dead metal parts (Pin type) 2,000 Vrms for 1 min: Between input and output	
	Insulation resistance (Initial value)	Between live and dead metal parts Min. 100 MΩ: Between input and output (At 500V DC) Between contacts		Min. 100 MΩ: Between live and dead metal parts Between input and output (At 500V DC)	
	Operating voltage reset time	Max. 0.5 s			
	Temperature rise	Max. 65° C (under the flow of nominal operating current at nominal voltage)		—	
Mechanical	Vibration resistance	Functional	10 to 55 Hz: 1 cycle/min single amplitude of 0.35 mm .014 inch (10 min on 3 axes)		
		Destructive	10 to 55 Hz: 1 cycle/min single amplitude of 0.75 mm .030 inch (1 h on 3 axes)		
	Shock resistance	Functional	Min. 98 m 321.522 ft./s ² (4 times on 3 axes)		
		Destructive	Min. 294 m 964.567 ft./s ² (5 times on 3 axes)		
Operating conditions	Ambient temperature	-10° C to 55° C +14° F to +131° F			
	Ambient humidity	Max. 85 % RH (non-condensing)			
	Air pressure	860 to 1,060 h Pa			
	Ripple rate	—	20 % or less	—	20 % or less
Connection	8-pin/11-pin/screw terminal				
Protective construction	IP66 (front panel with rubber gasket)				

Applicable standard

Safety standard	EN61812-1	Pollution Degree 2/Overvoltage Category II
EMC	(EMI)EN61000-6-4 Radiation interference electric field strength	EN55011 Group1 ClassA EN55011 Group1 ClassA
	Noise terminal voltage (EMS)EN61000-6-2 Static discharge immunity	EN61000-4-2 4 kV contact 8 kV air
	RF electromagnetic field immunity	EN61000-4-3 10 V/m AM modulation (80 MHz to 1 GHz) 10 V/m pulse modulation (895 MHz to 905 MHz)
	EFT/B immunity	EN61000-4-4 2 kV (power supply line) 1 kV (signal line)
	Surge immunity	EN61000-4-5 1 kV (power line)
	Conductivity noise immunity	EN61000-4-6 10 V/m AM modulation (0.15 MHz to 80 MHz)
	Power frequency magnetic field immunity	EN61000-4-8 30 A/m (50 Hz)
	Voltage dip/Instantaneous stop/Voltage fluctuation immunity	EN61000-4-11 10 ms, 30% (rated voltage) 100 ms, 60% (rated voltage) 1,000 ms, 60% (rated voltage) 5,000 ms, 95% (rated voltage)

Dimensions

• LT4H digital timer

(units: mm inch)
Tolerance: ±1.0 ±.039

Screw terminal type
(Flush mount)

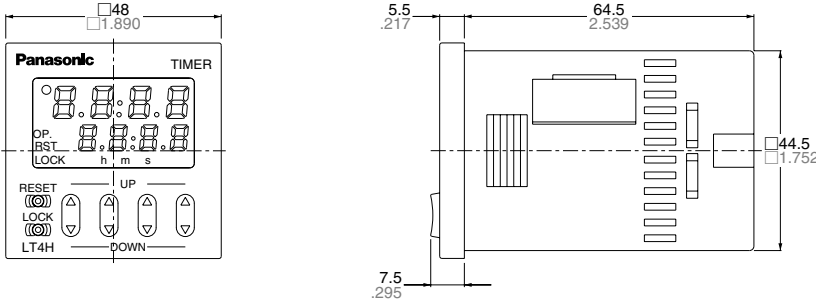

Pin type
(Flush mount/Surface mount)

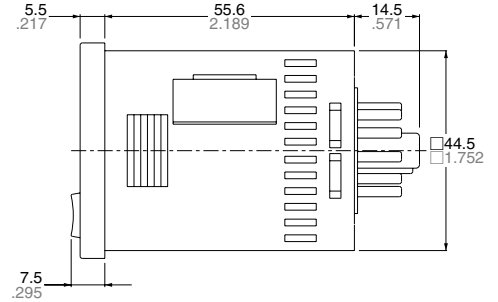

• Dimensions for embedded installation (with adapter installed)

Screw terminal type

Pin type

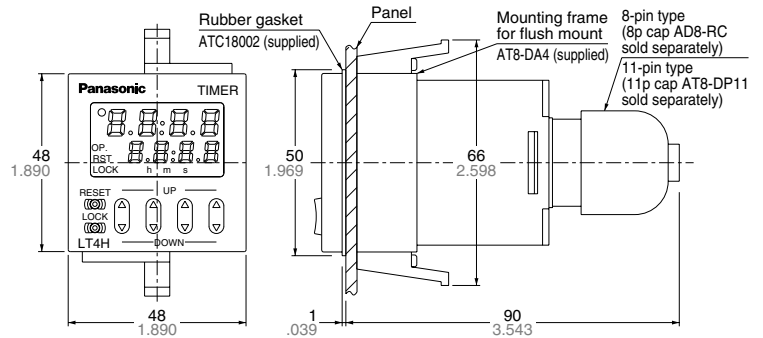
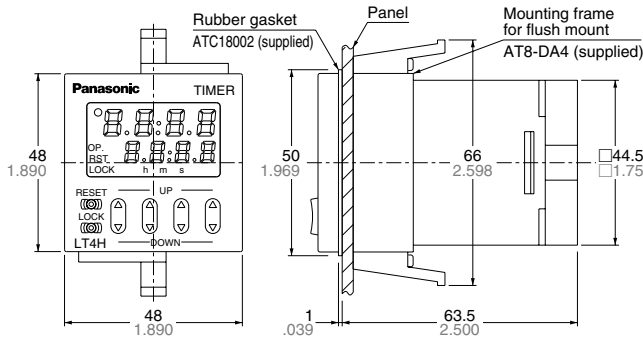

• Dimensions for front panel installations

• Installation panel cut-out dimensions

• For connected installations

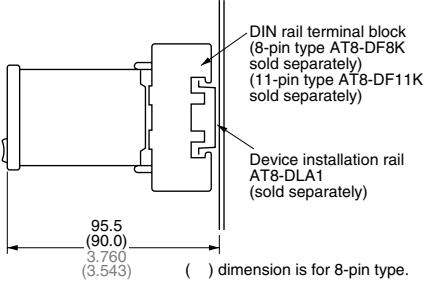

The standard panel cut-out dimensions are shown below. Use the mounting frame (AT8-DA4) and rubber gasket (ATC18002).

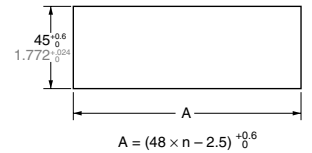
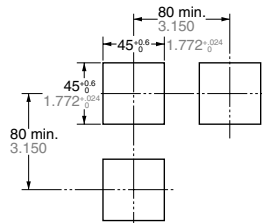

Note) 1: The installation panel thickness should be between 1 and 5 mm (.039 and .197 inch).
2: For connected installations, the waterproofing ability between the unit and installation panel is lost.

Terminal layouts and Wiring diagrams

• 8-pin type

Relay output type

Transistor output type

• 11-pin type

Relay output type

Transistor output type

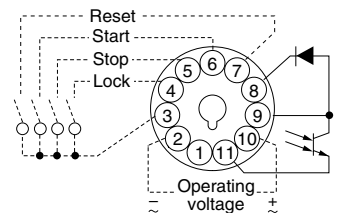
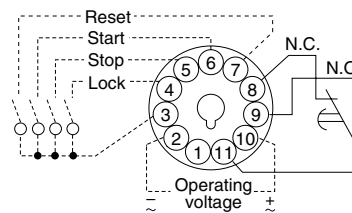
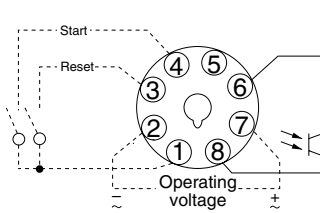
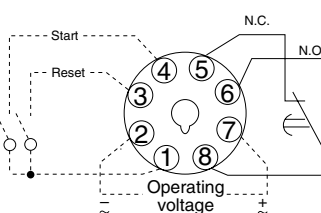

• Screw terminal type

Relay output type

Transistor output type

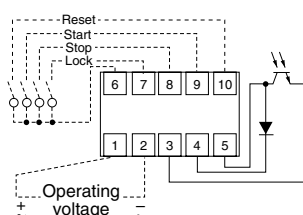
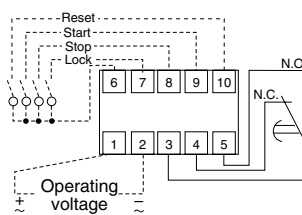

Note) For connecting the output leads of the transistor output type, refer to 5) Transistor output on page 48.

Setting the operation mode, time range, and time

Setting procedure 1) Setting the operation mode and time range

Set the operation mode and time range with the DIP switches on the side of the LT4H timer.

DIP switches

	Item	DIP switch	
		OFF	ON
1	Operation mode	Refer to table 1	
2			
3			
*4	Minimum input reset, start, and stop signal width	20 ms	1 ms
5	Time delay direction	Addition	Subtraction
6	Time range	Refer to table 2	
7			
8			

* The 8-pin type does not have the stop input, so that the dip switch can be changed over between reset and start inputs. The signal range of the lock input is fixed (minimum 20 ms).

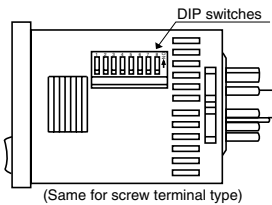

Table 1: Setting the operation mode

DIP switch No.			Operation mode
1	2	3	
ON	ON	ON	A: Power on delay 1
OFF	OFF	OFF	A2: Power on delay 2
ON	OFF	OFF	B: Signal on delay
OFF	ON	OFF	C: Signal off delay
ON	ON	OFF	D: Pulse One shot
OFF	OFF	ON	E: Pulse On delay
ON	OFF	ON	F: Signal Flicker
OFF	ON	ON	G: Totalizing On delay

Table 2: Setting the time range

DIP switch No.			Time range
6	7	8	
ON	ON	ON	0.001 s to 9.999 s
OFF	OFF	OFF	0.01 s to 99.99 s
ON	OFF	OFF	0.1 s to 999.9 s
OFF	ON	OFF	1 s to 9999 s
ON	ON	OFF	0 min 01 s to 99 min 59 s
OFF	OFF	ON	0.1 min to 999.9 min
ON	OFF	ON	0 h 01 min to 99 h 59 min
OFF	ON	ON	0.1 h to 999.9 h

- Notes: 1) Set the DIP switches before installing the timer.
 2) When the DIP SW setting is changed, turn off the power once.
 3) The DIP switches are set as ON before shipping.

Setting procedure 2) Setting the time

Set the set time with the keys (UP and DOWN keys) on the front of the LT4H timer.

Front display section

- ① Elapsed time display
- ② Set time display
- ③ Time delay indicator
- ④ Controlled output indicator
- ⑤ Reset indicator
- ⑥ Lock indicator
- ⑦ Time units display

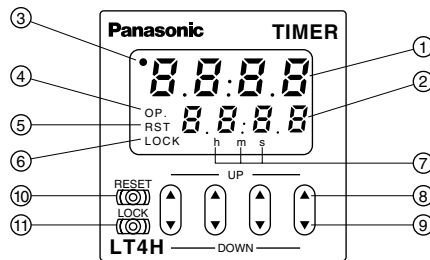

- ⑧ UP keys
Changes the corresponding digit of the set time in the addition direction (upwards)
- ⑨ DOWN keys
Changes the corresponding digit of the set time in the subtraction direction (downwards)
- ⑩ RESET switch
Resets the elapsed time and the output
- ⑪ LOCK switch
Locks the operation of all keys on the unit

• Changing the set time

1. It is possible to change the set time with the up and down keys even during time delay with the timer.

However, be aware of the following points.

- 1) If the set time is changed to less than the elapsed time with the time delay set to the addition direction, time delay will continue until the elapsed time reaches full scale, returns to zero, and then reaches the new set time. If the set time

is changed to a time above the elapsed time, the time delay will continue until the elapsed time reaches the new set time.

- 2) If the time delay is set to the subtraction direction, time delay will continue until "0" regardless of the new set time.

2. If the set time is changed to "0," the unit will operate differently depending on the operation mode.

- 1) If the operation mode is set to A (power on delay 1) or A2 (power on

delay 2), the output will turn on when the power supply is turned on. However, the output will be off while reset is being input.

- 2) In the other modes, the output turns on when the start is input. When the operation mode is C (signal off delay), D (Pulse one shot), or F (Signal flicker), only when the start input is on does the output turn on. Also, when the reset is being input, the output is off.

• Power failure memory

The EEPROM is used for power failure memory. It has a life of Min. 10⁵ over-writings.

The EEPROM is overwriting with the following timing.

Output mode	Overwrite timing
Power ON delay (2) A2	When power is OFF
Addition G	Change of preset value or start, reset input When power is OFF after being ON
Other modes	When power is OFF after changing preset value

* Be aware that the contents of EEPROM for all modes will be overwritten when power is turned OFF during input to external lock terminals ④ to ③ and ⑦ to ⑥. Such an action does not exist by doing lock operation from the front.

Operation mode

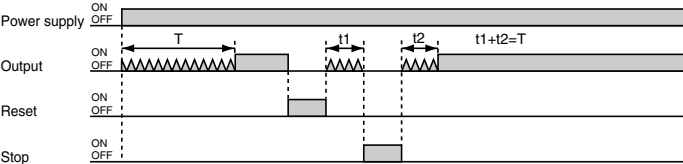
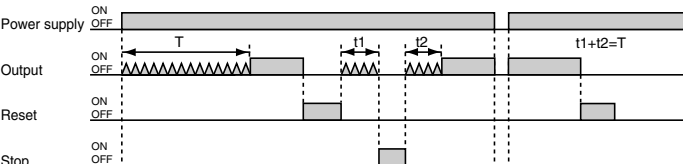
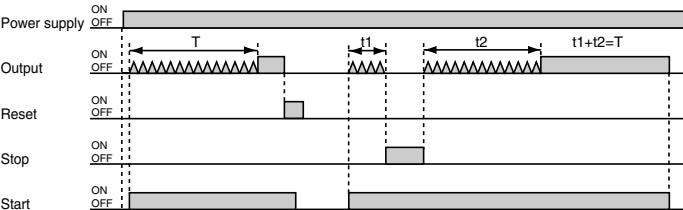
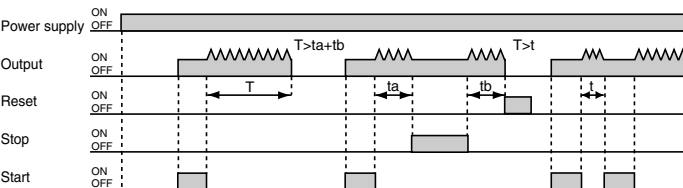
Operation type	Explanation	Time chart						
<p>Power on delay (1) Ⓐ</p>	<ul style="list-style-type: none"> Set the operation mode section of the DIP switches (no.'s 1, 2, and 3) on the side of the timer as shown. <table border="1" data-bbox="643 248 823 309"> <tr> <td>1</td> <td>2</td> <td>3</td> </tr> <tr> <td>ON</td> <td>ON</td> <td>ON</td> </tr> </table> Clears elapsed time value and starts time delay at power ON. After timer completion, stops at the display of the set value (addition), or stops at "0" (subtraction). Ignores start input. Stops delay time operation at stop ON. Restarts delay time operation at stop OFF. 	1	2	3	ON	ON	ON	
1	2	3						
ON	ON	ON						
<p>Power on delay (2) Ⓐ2</p>	<ul style="list-style-type: none"> Set the operation mode section of the DIP switches (no.'s 1, 2, and 3) on the side of the timer as shown. <table border="1" data-bbox="643 712 823 772"> <tr> <td>1</td> <td>2</td> <td>3</td> </tr> <tr> <td>OFF</td> <td>OFF</td> <td>OFF</td> </tr> </table> Elapsed time value does not clear at power ON. (power outage countermeasure function) The output remains ON even after the power is cut and restarted. After timer completion, stops at the display of the set value (addition), or stops at "0" (subtraction). Ignores start input. Stops delay time operation at stop ON. Restarts delay time operation at stop OFF. 	1	2	3	OFF	OFF	OFF	
1	2	3						
OFF	OFF	OFF						
<p>Signal on delay Ⓑ</p>	<ul style="list-style-type: none"> Set the operation mode section of the DIP switches (no.'s 1, 2, and 3) on the side of the timer as shown. <table border="1" data-bbox="643 1182 823 1243"> <tr> <td>1</td> <td>2</td> <td>3</td> </tr> <tr> <td>ON</td> <td>OFF</td> <td>OFF</td> </tr> </table> Clears elapsed time value at power ON. Time delay starts at start ON and elapsed time value or output resets at start OFF. Instantaneous time delay start at reset OFF and power ON while start is ON. Stops delay time operation at stop ON. Restarts delay time operation at stop OFF. In order to have the time delay start at power ON or reset at power OFF, short out the start input beforehand. 	1	2	3	ON	OFF	OFF	
1	2	3						
ON	OFF	OFF						
<p>Signal off delay Ⓒ</p>	<ul style="list-style-type: none"> Set the operation mode section of the DIP switches (no.'s 1, 2, and 3) on the side of the timer as shown. <table border="1" data-bbox="643 1653 823 1713"> <tr> <td>1</td> <td>2</td> <td>3</td> </tr> <tr> <td>OFF</td> <td>ON</td> <td>OFF</td> </tr> </table> Clears elapsed time value at power ON. Output control ON at start ON and time delay start at start OFF. Elapsed time value clears when start goes ON again during time delay. Stops delay time operation at stop ON. Restarts delay time operation at stop OFF. 	1	2	3	OFF	ON	OFF	
1	2	3						
OFF	ON	OFF						

Notes: 1) Each signal input (start, reset, stop, and lock) is applied by shorting their input terminal to the common terminal (terminal ① for the 8-pin type, terminal ③ for the 11-pin type, and terminal ⑥ for the screw terminal type).
2) The 8-pin type does not have a stop input or lock input.

Operation type	Explanation	Time chart						
Pulse One-shot (D)	<ul style="list-style-type: none"> Set the operation mode section of the DIP switches (no.'s 1, 2, and 3) on the side of the timer as shown. <table border="1" data-bbox="564 248 746 309"> <tr> <td>1</td> <td>2</td> <td>3</td> </tr> <tr> <td>ON</td> <td>ON</td> <td>OFF</td> </tr> </table> Clears elapsed time value at power ON. Time delay starts and output control ON at start ON. Turns output control OFF and clears elapsed time value at time-up. Turns output control OFF and clears elapsed time value at time-up. Ignores start input during time delay. Stops delay time operation at stop ON. Restarts delay time operation at stop OFF. In order to have the time delay start at power ON or reset at power OFF, short out the start input beforehand. 	1	2	3	ON	ON	OFF	
1	2	3						
ON	ON	OFF						
Pulse On delay (E)	<ul style="list-style-type: none"> Set the operation mode section of the DIP switches (no.'s 1, 2, and 3) on the side of the timer as shown. <table border="1" data-bbox="564 714 746 775"> <tr> <td>1</td> <td>2</td> <td>3</td> </tr> <tr> <td>OFF</td> <td>OFF</td> <td>ON</td> </tr> </table> Clears elapsed time value at power ON. Time delay starts at start ON. Ignores start input during time delay. Stops delay time operation at stop ON. Restarts delay time operation at stop OFF. In order to have the time delay start at power ON or reset at power OFF, short out the start input beforehand. 	1	2	3	OFF	OFF	ON	
1	2	3						
OFF	OFF	ON						
Signal Flicker (F)	<ul style="list-style-type: none"> Set the operation mode section of the DIP switches (no.'s 1, 2, and 3) on the side of the timer as shown. <table border="1" data-bbox="564 1182 746 1243"> <tr> <td>1</td> <td>2</td> <td>3</td> </tr> <tr> <td>ON</td> <td>OFF</td> <td>ON</td> </tr> </table> Clears elapsed time value at power ON. Time delay starts at start ON. Ignores start input during time delay. Output control reverses, elapsed time value clears, and timer delay starts at timer completion. Stops delay time operation at stop ON. Restarts delay time operation at stop OFF. In order to have the time delay start at power ON or reset at power OFF, short out the start input beforehand. 	1	2	3	ON	OFF	ON	
1	2	3						
ON	OFF	ON						
Totalizing On delay (G)	<ul style="list-style-type: none"> Set the operation mode section of the DIP switches (no.'s 1, 2, and 3) on the side of the timer as shown. <table border="1" data-bbox="564 1650 746 1711"> <tr> <td>1</td> <td>2</td> <td>3</td> </tr> <tr> <td>OFF</td> <td>ON</td> <td>ON</td> </tr> </table> Elapsed time value does not clear at power ON. (power outage countermeasure function) The output remains ON even after the power is off and restarted. Stops delay time operation at stop ON. Restarts delay time operation at stop OFF. 	1	2	3	OFF	ON	ON	
1	2	3						
OFF	ON	ON						

Notes: 1) Each signal input (start, reset, stop, and lock) is applied by shorting their input terminal to the common terminal (terminal ① for the 8-pin type, terminal ③ for the 11-pin type, and terminal ⑥ for the screw terminal type).
 2) The 8-pin type does not have a stop input or lock input.