



Chipsmall Limited consists of a professional team with an average of over 10 year of expertise in the distribution of electronic components. Based in Hongkong, we have already established firm and mutual-benefit business relationships with customers from,Europe,America and south Asia,supplying obsolete and hard-to-find components to meet their specific needs.

With the principle of “Quality Parts,Customers Priority,Honest Operation,and Considerate Service”,our business mainly focus on the distribution of electronic components. Line cards we deal with include Microchip,ALPS,ROHM,Xilinx,Pulse,ON,Everlight and Freescale. Main products comprise IC,Modules,Potentiometer,IC Socket,Relay,Connector.Our parts cover such applications as commercial,industrial, and automotives areas.

We are looking forward to setting up business relationship with you and hope to provide you with the best service and solution. Let us make a better world for our industry!



## Contact us

Tel: +86-755-8981 8866 Fax: +86-755-8427 6832

Email & Skype: info@chipsmall.com Web: www.chipsmall.com

Address: A1208, Overseas Decoration Building, #122 Zhenhua RD., Futian, Shenzhen, China



**OBSOLETE:**

FOR INFORMATION PURPOSES ONLY  
 Contact Linear Technology for Potential Replacement

## FEATURES

- Single 1.8V to 5.25V Supply
- Direct IQ Modulator with Integrated 90° Phase Shifter\*
- 4-Step RF Power Control
- 120MHz Modulation Bandwidth
- Independent Double-Balanced Mixer
- Modulation Accuracy Insensitive to Carrier Input Power
- Modulator I/Q Inputs Internally Biased
- Available in 20-Lead FE Package

## APPLICATIONS

- IEEE 802.11 DSSS and FHSS
- High Speed Wireless LAN (WLAN)
- Wireless Local Loop (WLL)
- PCS Wireless Data
- MMDS

## DESCRIPTION

The **LT<sup>®</sup>5503** is a front-end transmitter IC designed for low voltage operation. The IC contains a high frequency quadrature modulator with a variable gain amplifier (VGA) and a balanced mixer. The modulator includes a precision 90° phase shifter which allows direct modulation of an RF signal by the baseband I and Q signals.

In a superheterodyne system, the mixer can be used to generate the high frequency RF input for the modulator by mixing the system's 1st and 2nd local oscillators.

The LT5503 modulator output P 1dB is -3dBm at 2.5GHz. The VGA allows output power reduction in three steps up to 13dB with digital control. The baseband inputs are internally biased for maximum input voltage swing at low supply voltage. If needed, they can be driven with external bias voltages.

LT<sup>®</sup>, LT, LTC, LTM, Linear Technology and the Linear logo are registered trademarks of Linear Technology Corporation. All other trademarks are the property of their respective owners. Patents pending.

## TYPICAL APPLICATION

### 2.45GHz Transmitter Application, Carrier for Modulator Generated by Upmixer

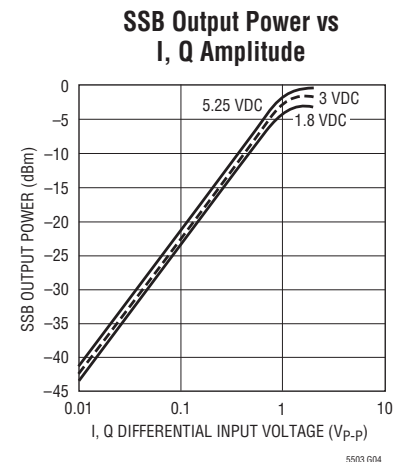
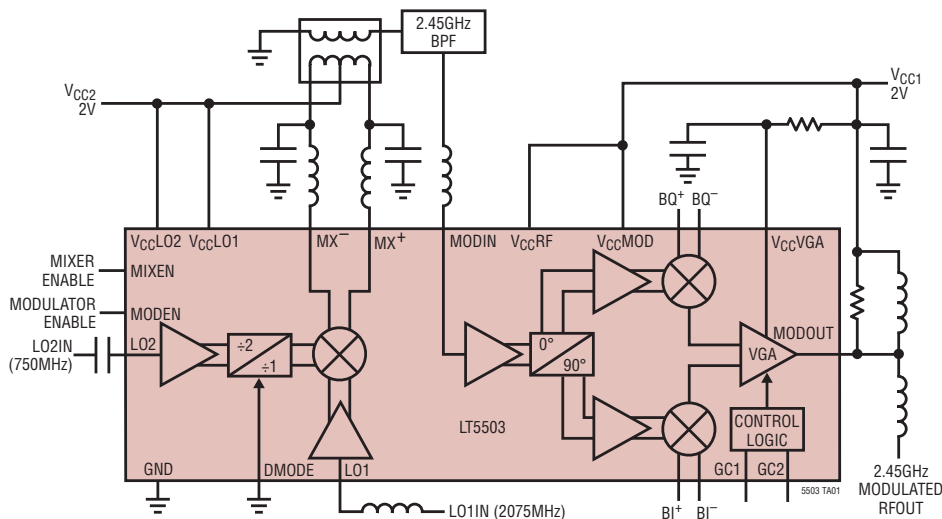

## ABSOLUTE MAXIMUM RATINGS

(Note 1)

Supply Voltage .....	5.5V
Control Voltages .....	-0.3V to ( $V_{CC} + 0.3V$ )
Baseband Voltages ( $BI^+$ to $BI^-$ and $BQ^+$ to $BQ^-$ ) .....	$\pm 2V$
Baseband Common Mode Voltage .....	1V to ( $V_{CC} - 0.3V$ )
LO1 Input Power .....	4dBm
LO2 Input Power .....	4dBm
MODIN Input Power .....	4dBm
Operating Temperature Range .....	-40°C to 85°C
Storage Temperature Range .....	-65°C to 150°C
Lead Temperature (Soldering, 10 sec).....	300°C

## PIN CONFIGURATION

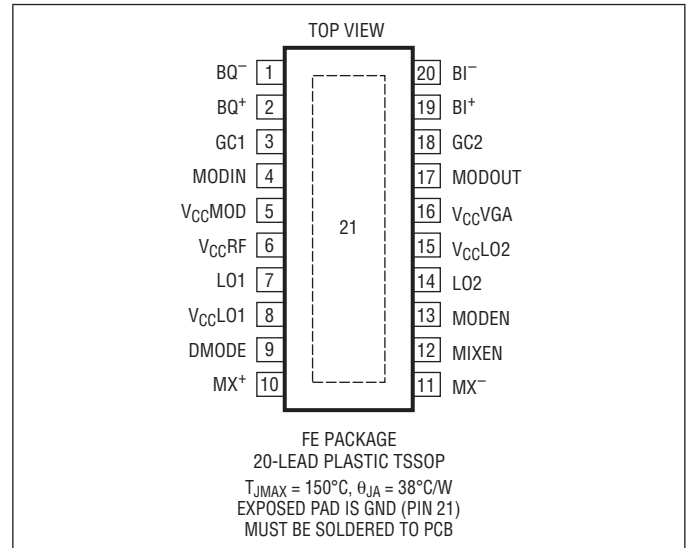

## ORDER INFORMATION

LEAD FREE FINISH	TAPE AND REEL	PART MARKING	PACKAGE DESCRIPTION	TEMPERATURE RANGE
<b>OBSOLETE PART</b>				
LT5503EFE#PBF	LT5503EFE#TRPBF	5503	20-Lead Plastic TSSOP	-40°C to 85°C

Consult LTC Marketing for parts specified with wider operating temperature ranges.

Consult LTC Marketing for information on non-standard lead based finish parts.

For more information on lead free part marking, go to: <http://www.linear.com/leadfree/>

For more information on tape and reel specifications, go to: <http://www.linear.com/tapeandreeel/>



**ELECTRICAL CHARACTERISTICS** (I/Q Modulator)

$V_{CC1} = 3VDC$ , 2.4GHz matching, MODEN = High, GC1 = GC2 = Low,  $T_A = 25^\circ C$ , MODRFIN = 2.45GHz at  $-16dBm$ ,  $[I - I_B]$  and  $[Q - Q_B] = 100kHz$  CW signal at  $1V_{P-P}$  differential, Q leads I by  $90^\circ$ , unless otherwise noted. (Test circuit shown in Figure 2.) (Note 3)

PARAMETER	CONDITIONS	MIN	TYP	MAX	UNITS
<b>RF Carrier Input (MODRFIN)</b>					
Frequency Range <sup>2</sup>	Requires Appropriate Matching		1.2 to 2.7		GHz
Input VSWR	$Z_0 = 50\Omega$		1.3:1		
Input Power			-20 to -10		dBm
<b>Baseband Inputs (BI<sup>+</sup>, BI<sup>-</sup>, BQ<sup>+</sup>, BQ<sup>-</sup>)</b>					
Frequency Bandwidth (3dB)			120		MHz
Differential Input Voltage for 1dB Compressed Output			1		$V_{P-P}$
DC Common Mode Voltage	Internally Biased		1.4		VDC
Differential Input Resistance			18		$k\Omega$
Input Capacitance			0.8		pF
Gain Error			$\pm 0.2$		dB
Phase Error			$\pm 1$		DEG
<b>Modulated RF Carrier Output (MODRFOUT)</b>					
Output Power, Max Gain		-6	-3		dBm
Output VSWR	$Z_0 = 50\Omega$		1.5:1		
Image Suppression		-26	-34		dBc
Carrier Suppression		-24	-32		dBc
Output 1dB Compression			-3		dBm
Output 3rd Order Intercept	$f_1 = 100kHz, f_Q = 120kHz$		2		dBm
Output 2rd Order Intercept	$f_1 = 100kHz, f_Q = 120kHz$		16		dBm
Broadband Noise	20MHz Offset		-142		dBm/Hz
<b>VGA Control Logic (GC2, GC1)</b>					
Switching Time			100		ns
Input Current			2		$\mu A$
Input Low Voltage				0.4	VDC
Input High Voltage		1.7			VDC
Output Power Attenuation	GC2 = Low, GC1 = High		4.5		dB
Output Power Attenuation	GC2 = High, GC1 = Low		9		dB
Output Power Attenuation	GC2 = High, GC1 = High		13.5		dB
<b>Modulator Enable (MODEN) Low = Off, High = On</b>					
Turn ON/OFF Time			1		$\mu s$
Input Current			105		$\mu A$
Enable		$V_{CC} - 0.4$			VDC
Disable				0.4	VDC
<b>Modulator Power Supply Requirements</b>					
Supply Voltage		1.8		5.25	VDC
Modulator Supply Current	MODEN = High		29	38	mA
Modulator Shutdown Current	MODEN = Low			50	$\mu A$

## ELECTRICAL CHARACTERISTICS (Mixer)

$V_{CC2} = 3\text{VDC}$ , 2.4GHz matching, MIXEN = High, DMODE = Low (LO2 ÷ 2 mode),  $T_A = 25^\circ\text{C}$ , LO2IN = 750MHz at -18dBm, LO1IN = 2075MHz at -12dBm. MIXRFOUT measured at 2450MHz, unless otherwise noted. (Test circuit shown in Figure 2.) (Note 3)

PARAMETER	CONDITIONS	MIN	TYP	MAX	UNITS
<b>Mixer 2nd LO Input (LO2IN)</b>					
Frequency Range	Internally Matched		50 to 1000		MHz
Input VSWR	$Z_0 = 50\Omega$		1.4:1		
Input Power			-20 to -12		dBm
<b>Mixer 1st LO Input (LO1IN)</b>					
Frequency Range <sup>2</sup>	Requires Appropriate Matching		1400 to 2400		MHz
Input VSWR	$Z_0 = 50\Omega$		1.5:1		
Input 3rd Order Intercept	-30dBm/Tone, $\Delta f = 200\text{kHz}$		-12		dBm
<b>Mixer RF Output (MIXRFOUT)</b>					
Frequency Range <sup>2</sup>	Requires Appropriate Matching		1700 to 2700		MHz
Output VSWR	$Z_0 = 50\Omega$		1.5:1		
Small-Signal Conversion Gain	$P_{LO1} = -30\text{dBm}$		5		dB
Output Power		-14.7	-12.7		dBm
LO1 Suppression		-22	-29		dBc
Output 1dB Compression			-15		dBm
Broadband Noise	20MHz Offset		-152		dBm/Hz
<b>LO2 Divider Mode Control (DMODE) Low = <math>f_{LO2} \div 2</math>, High = <math>f_{LO2} \div 1</math></b>					
Input Current			1		$\mu\text{A}$
Input Low Voltage ( $\div 2$ )				0.4	VDC
Input High Voltage ( $\div 1$ )		$V_{CC} - 0.4$			VDC
<b>Mixer Enable (MIXEN) Low = Off, High = On</b>					
Turn ON/OFF Time			1		$\mu\text{s}$
Input Current			130		$\mu\text{A}$
Enable		$V_{CC} - 0.4$			VDC
Disable				0.4	VDC
<b>Mixer Power Supply Requirements</b>					
Supply Voltage		1.8		5.25	VDC
Supply Current ( $\div 2$ mode)	DMODE = Low, MIXEN = High		11.9	15.5	mA
Supply Current ( $\div 1$ mode)	DMODE = High, MIXEN = High		10.8		mA
Shutdown Current	MIXEN = Low			10	$\mu\text{A}$

**Note 1:** Stresses beyond those listed under Absolute Maximum Ratings may cause permanent damage to the device. Exposure to any Absolute Maximum Rating condition for extended periods may affect device reliability and lifetime.

**Note 2:** External component values on the final test circuit shown in Figure 2 are optimized for operation in the 2.4GHz to 2.5GHz band.

**Note 3:** Specifications over the -40°C to 85°C temperature range are assured by design, characterization and correlation with statistical process controls.

# TYPICAL PERFORMANCE CHARACTERISTICS (I/Q Modulator)

$V_{CC1} = 3VDC$ , 2.4GHz matching, MODEN = high, GC1 = GC2 = low (max gain),  $T_A = 25^\circ C$ , MODRFIN = 2.45GHz at  $-16dBm$ ,  $(I-I_B)$  and  $(Q-Q_B) = 100kHz$  sine at  $1V_{P-P}$  differential, Q leads I by  $90^\circ$ , unless otherwise noted. (Test circuit shown in Figure 2.)

**Modulator Supply Current vs Supply Voltage**

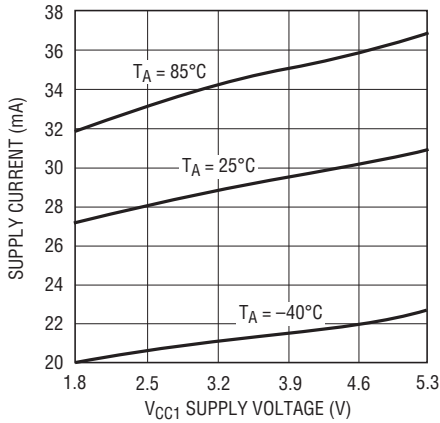

5503 G01

**Modulator Shutdown Current vs Supply Voltage**

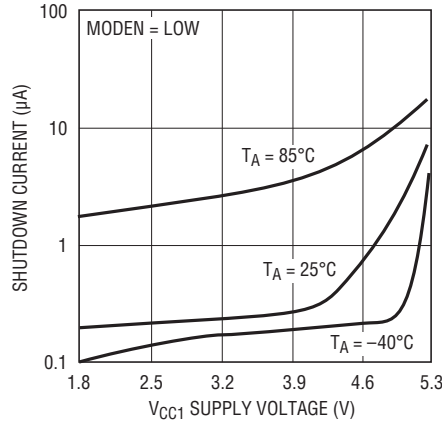

5503 G02

**MODEN Current vs Enable Voltage**

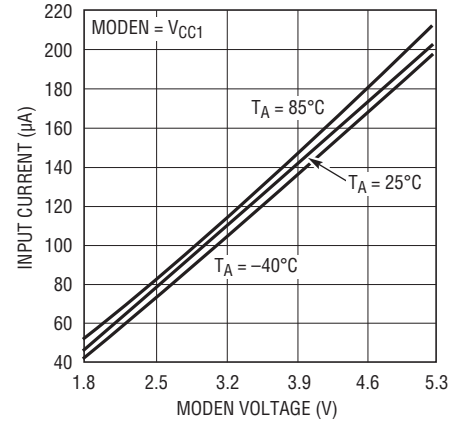

5503 G03

**2.45GHz Modulated Output Power vs Supply Voltage**

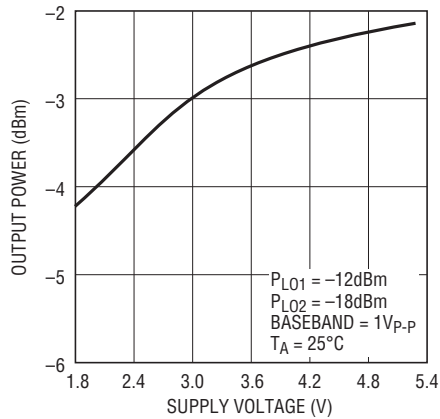

5503 TA01b

**Baseband Frequency Response I/Q Amplitude = 1Vp-p**

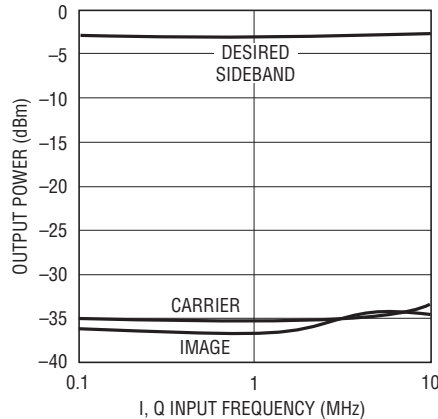

5503 G05

**MODRFIN and MODRFOUT Return Loss 2.4GHz Matching**

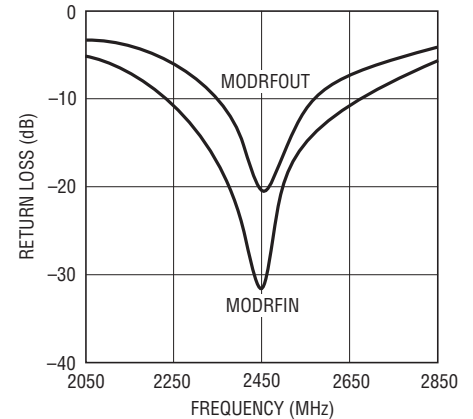

5503 G06

**Typical SSB Spectrum**

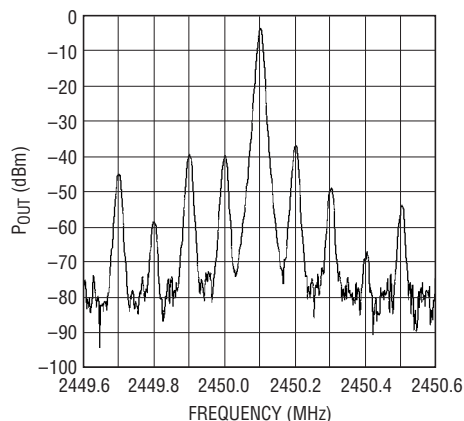

5503 G07

**TYPICAL PERFORMANCE CHARACTERISTICS** (I/Q Modulator)

2.4GHz matching, MODEN = high, GC1 = GC2 = low (max gain), MODRFIN = 2.45GHz, (I-I<sub>B</sub>) and (Q-Q<sub>B</sub>) = 100kHz sine at 1V<sub>p-p</sub> differential, Q leads I by 90°, unless otherwise noted. (Test circuit shown in Figure 2.)

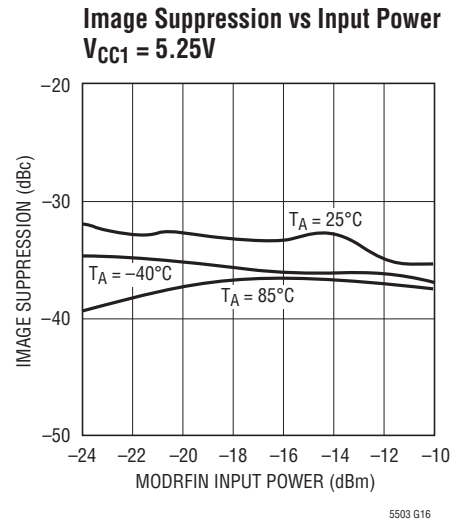
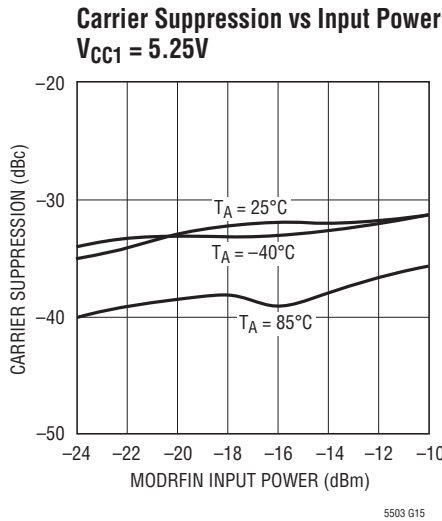
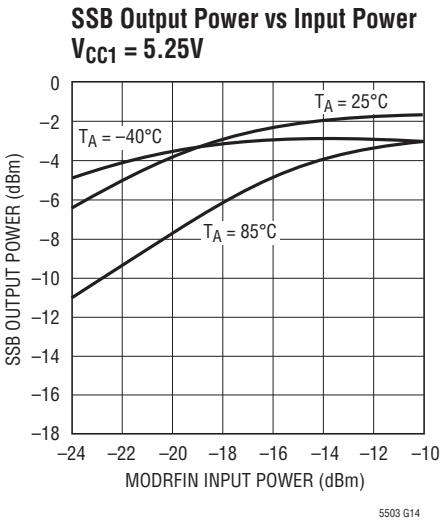
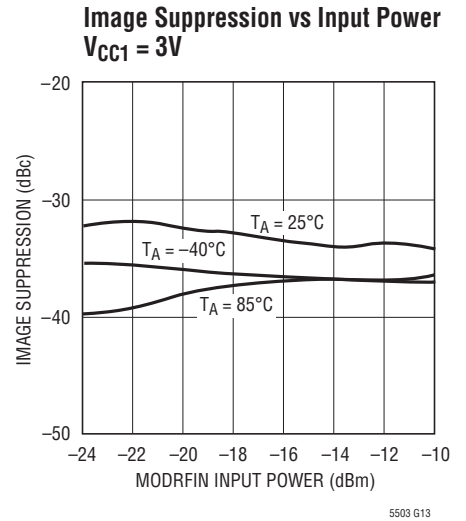
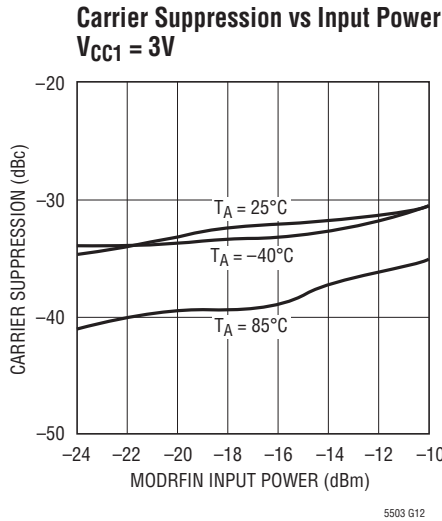
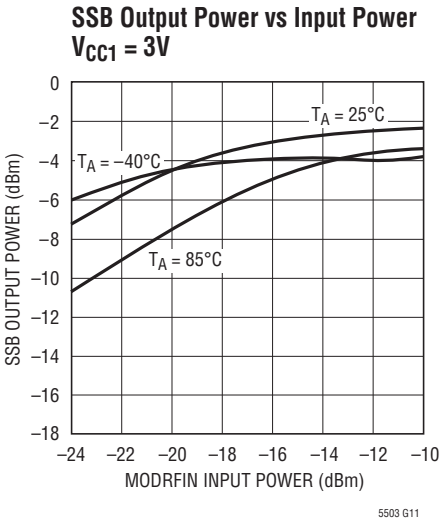
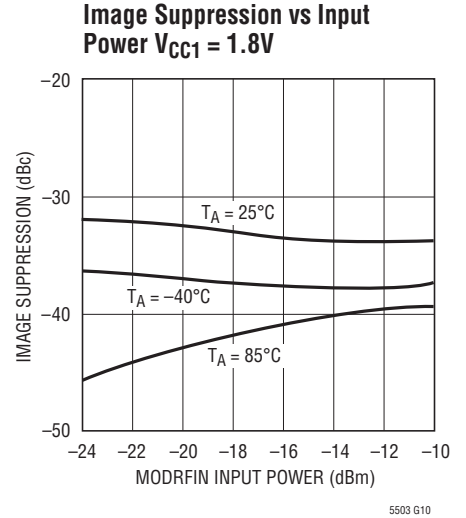
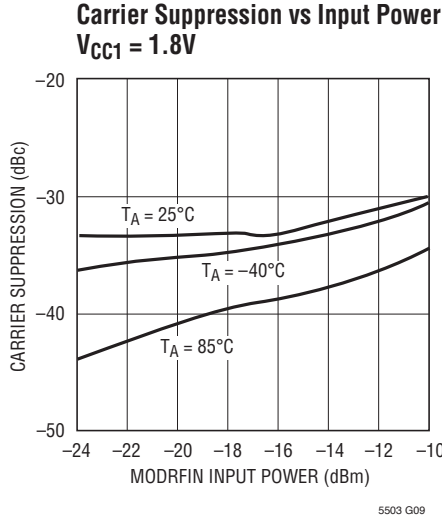
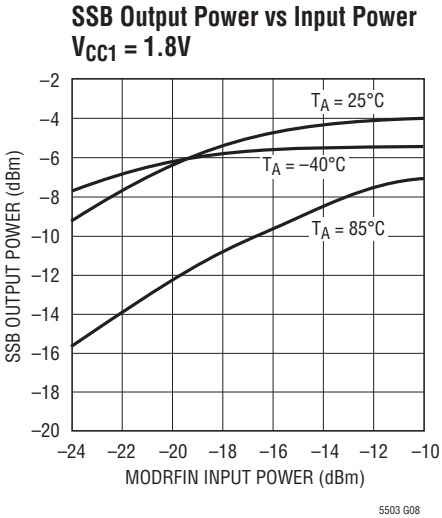

# TYPICAL PERFORMANCE CHARACTERISTICS (I/Q Modulator)

$V_{CC1} = 3VDC$ ,  $MODEN = high$ ,  $T_A = 25^\circ C$ ,  $P_{MODRFIN} = -16dBm$ ,  $(I-I_B)$  and  $(Q-Q_B) = 100kHz$  sine at  $1V_{P-P}$  differential,  $Q$  leads  $I$  by  $90^\circ$ , unless otherwise noted. (Test circuit shown in Figure 2.)

**Output Power vs Frequency  
1.2GHz Matching**

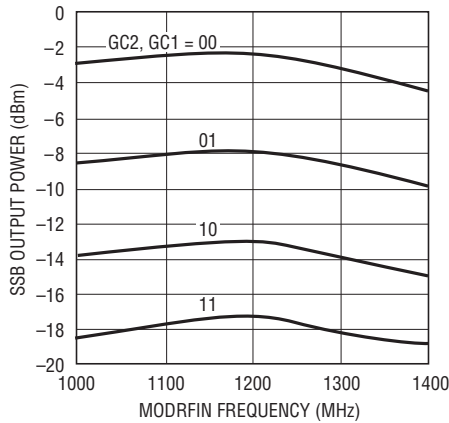

5503 G17

**Carrier Feedthrough vs Frequency  
1.2GHz Matching**

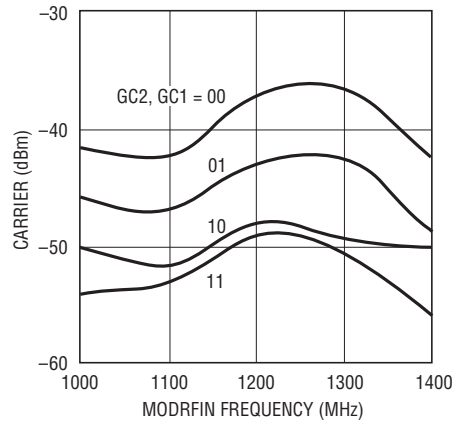

5503 G18

**SSB Image vs Frequency  
1.2GHz Matching**

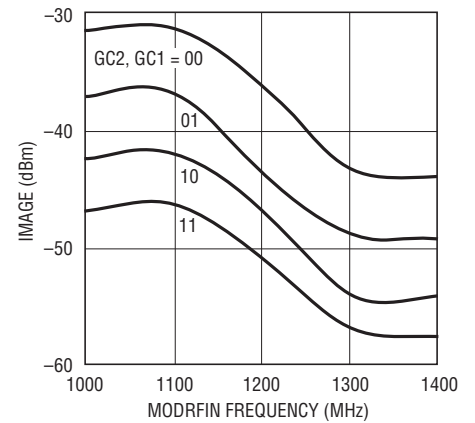

5503 G19

**Output Power vs Frequency  
1.9GHz Matching**

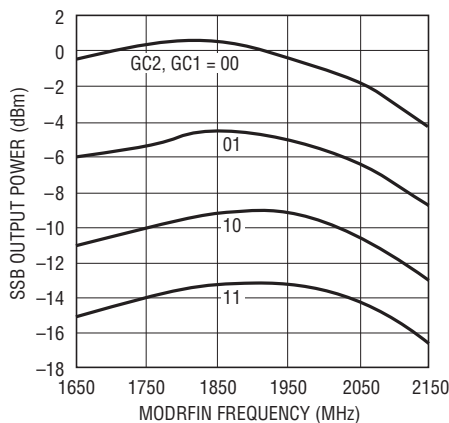

5503 G20

**Carrier Feedthrough vs Frequency  
1.9GHz Matching**

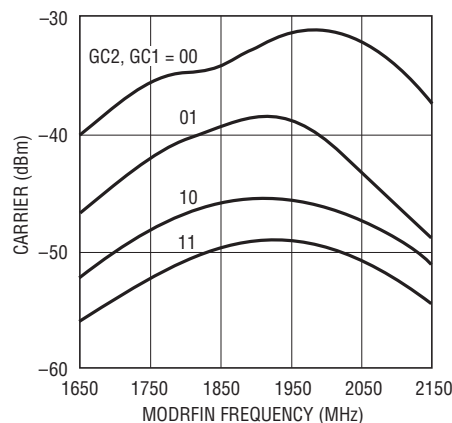

5503 G21

**SSB Image vs Frequency  
1.9GHz Matching**

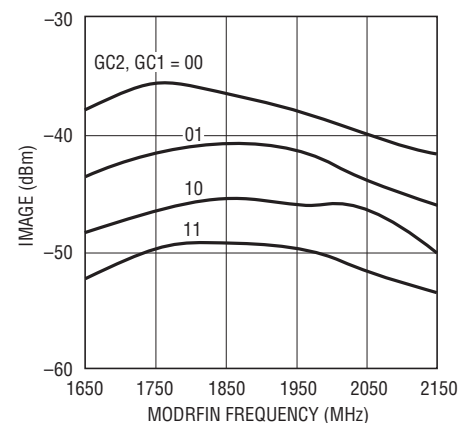

5503 G22

**Output Power vs Frequency  
2.4GHz Matching**

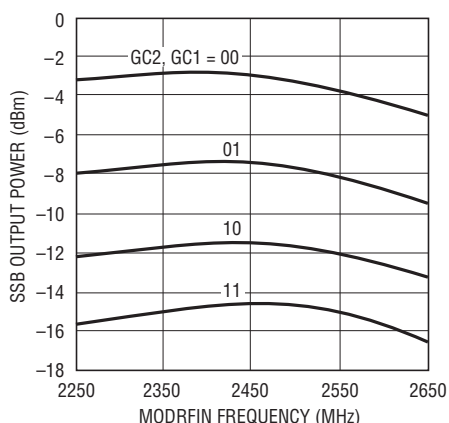

5503 G23

**Carrier Feedthrough vs Frequency  
2.4GHz Matching**

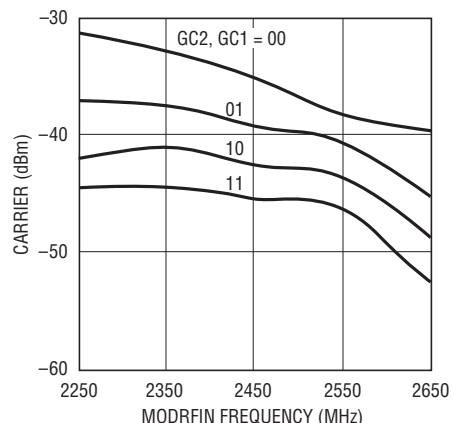

5503 G24

**SSB Image vs Frequency  
2.4GHz Matching**

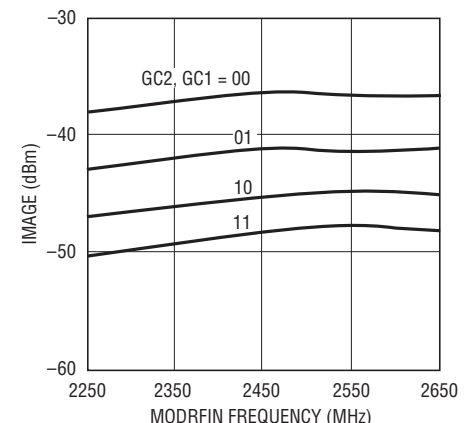

5503 G25

5503fa



## TYPICAL PERFORMANCE CHARACTERISTICS (Mixer)

2.4GHz matching, MIXEN = high, DMODE = low (LO2 ÷ 2 mode), LO2IN = 750MHz at -18dBm, LO1IN = 2075MHz. MIXRFOUT measured at 2450MHz, unless otherwise noted. (Test circuit shown in Figure 2.)

**Mixer Supply Current vs Supply Voltage (LO2 ÷ 2 Mode)**

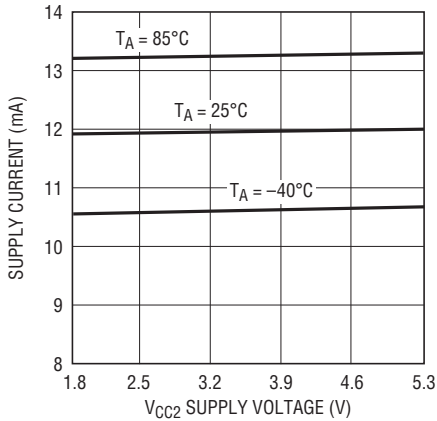

5503 G26

**Mixer Supply Current vs Supply Voltage (LO2 ÷ 1 Mode)**

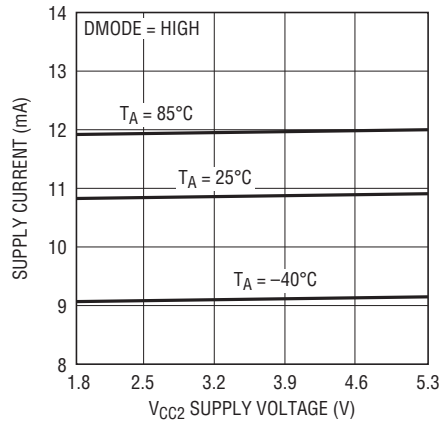

5503 G27

**Mixer Shutdown Current vs Supply Voltage**

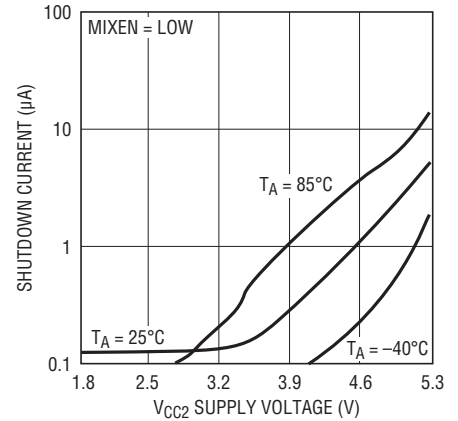

5503 G28

**RF Output Power vs LO1 Input Power (VCC2 = 1.8V)**

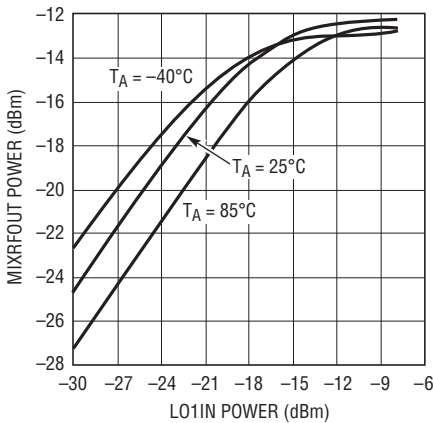

1195 G29

**RF Output Power vs LO1 Input Power (VCC2 = 3V)**

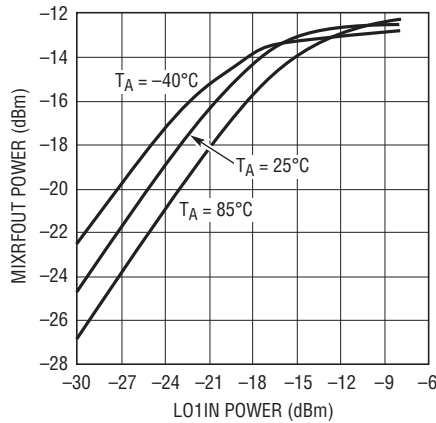

1195 G30

**RF Output Power vs LO1 Input Power (VCC2 = 5.25V)**

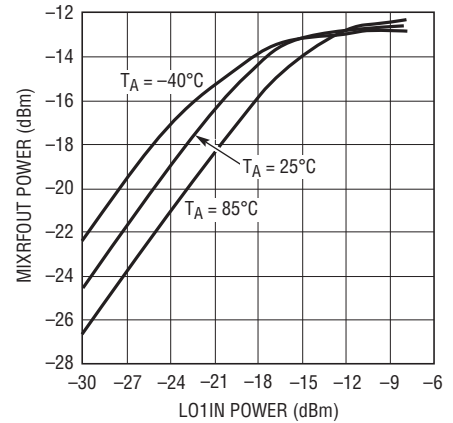

1195 G31

**LO1 Feedthrough vs LO1 Input Power (VCC2 = 1.8V)**

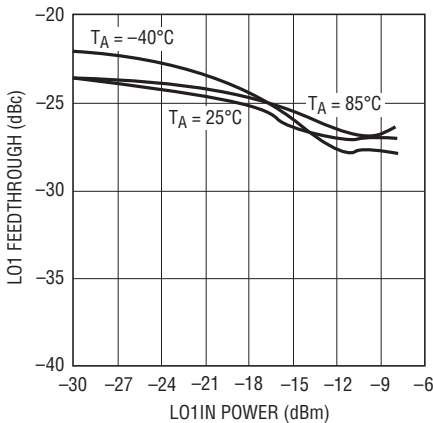

1195 G32

**LO1 Feedthrough vs LO1 Input Power (VCC2 = 3V)**

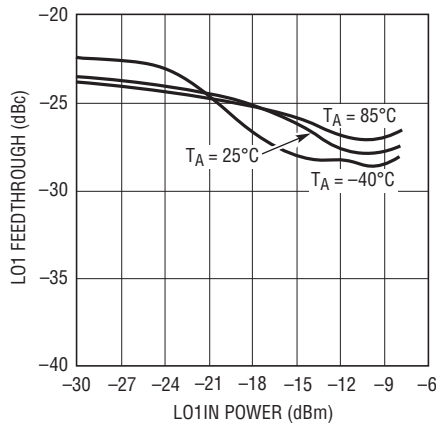

1195 G33

**LO1 Feedthrough vs LO1 Input Power (VCC2 = 5.25V)**

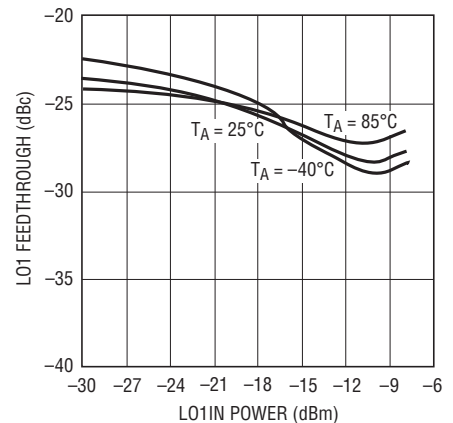

1195 G34

5503fa

# TYPICAL PERFORMANCE CHARACTERISTICS (Mixer)

$V_{CC2} = 3VDC$ , MIXEN = high, DMODE = low (LO2 ÷ 2mode),  $T_A = 25^\circ C$ , unless otherwise noted. (Test circuit shown in Figure 2.)

**RF Output Power and LO1 Feedthrough 1.9GHz Matching**

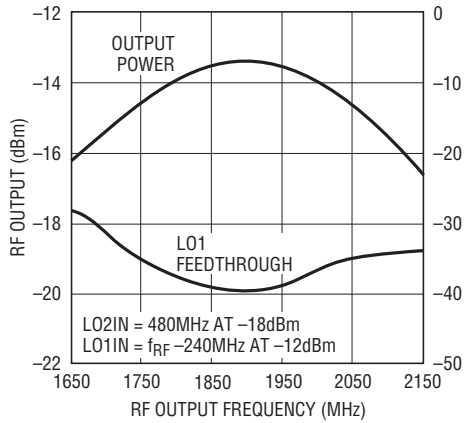

5503 G35

**Small-Signal Conversion Gain and IIP3 1.9GHz Matching**

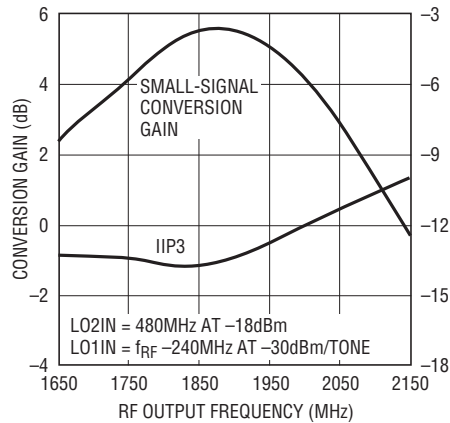

5503 G36

**LO1IN and MIXRFOUT Return Loss 1.9GHz Matching**

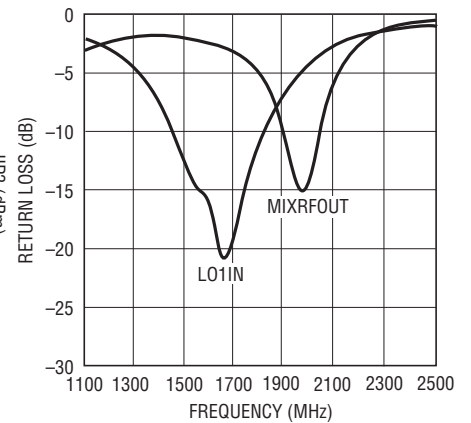

5503 G37

**RF Output Power and LO1 Feedthrough 2.4GHz Matching**

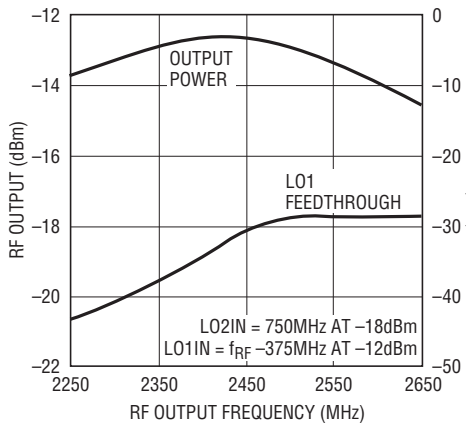

5503 G38

**Small-Signal Conversion Gain and IIP3 2.4GHz Matching**

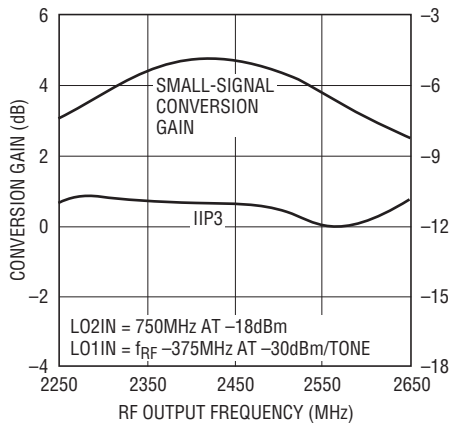

5503 G39

**LO1 and MIXRFOUT Return Loss 2.4GHz Matching**

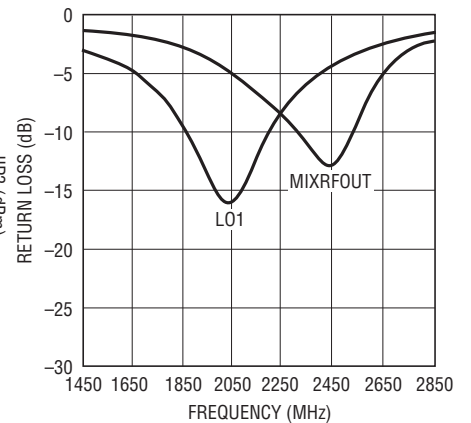

5503 G40

**MIXEN Input Current vs Enable Voltage (MIXEN =  $V_{CC2}$ )**

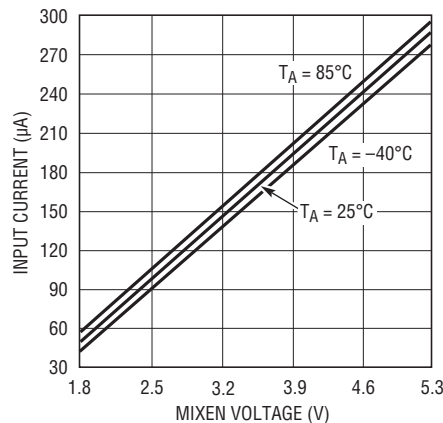

5503 G41

5503fa

## PIN FUNCTIONS

**BQ<sup>-</sup> (Pin 1):** Negative Baseband Input Pin of the Modulator Q-Channel. This pin is internally biased to 1.4V, but can also be overdriven with an external DC voltage greater than 1.4V, but less than  $V_{CC} - 0.4V$ .

**BQ<sup>+</sup> (Pin 2):** Positive Baseband Input Pin of Modulator Q-Channel. This pin is internally biased to 1.4V, but can also be overdriven with an external DC voltage greater than 1.4V, but less than  $V_{CC} - 0.4V$ .

**GC1 (Pin 3):** Gain Control Pin. This pin is the least significant bit of the 4-step modulator gain control.

**MODIN (Pin 4):** Modulator Carrier Input Pin. This pin is internally biased and should be AC-coupled. An external matching network is required for a  $50\Omega$  source.

**V<sub>CC</sub>MOD (Pin 5):** Power Supply Pin for the I/Q Modulator. This pin should be externally connected to the other  $V_{CC}$  pins and decoupled with 1000pF and 0.1 $\mu$ F capacitors.

**V<sub>CC</sub>RF (Pin 6):** Power Supply Pin for the I/Q Modulator Input RF Buffer and Phase Shifter. This pin should be externally connected to the other  $V_{CC}$  pins and decoupled with 1000pF and 0.1 $\mu$ F capacitors.

**LO1 (Pin 7):** Mixer 1st LO Input Pin. This pin is internally biased and should be AC-coupled. An external matching network is required for a  $50\Omega$  source.

**V<sub>CC</sub>LO1 (Pin 8):** Power Supply Pin for the Mixer LO1 Circuits. This pin should be externally connected to the other  $V_{CC}$  pins and decoupled with 1000pF and 0.1 $\mu$ F capacitors.

**DMODE (Pin 9):** Mixer 2nd LO Divider Mode Control Pin. Low = divide-by-2, High = divide-by-1.

**MX<sup>+</sup> (Pin 10):** Mixer Positive RF Output Pin. This pin must be connected to  $V_{CC}$  through an external matching network.

**MX<sup>-</sup> (Pin 11):** Mixer Negative RF Output Pin. This pin must be connected to  $V_{CC}$  through an external matching network.

**MIXEN (Pin 12):** Mixer Enable Pin. When the input voltage is higher than  $V_{CC} - 0.4V$ , the mixer circuits supplied through pins 8, 10, 11 and 15 are enabled. When the input voltage is less than 0.4V, these circuits are disabled.

**MODEN (Pin 13):** Modulator Enable Pin. When the input voltage is higher than  $V_{CC} - 0.4V$ , the modulator circuits supplied through pins 5, 6, 16 and 17 are enabled. When the input voltage is less than 0.4V, these circuits are disabled.

**LO2 (Pin 14):** Mixer 2nd LO Input Pin. This pin is internally biased and should be AC-coupled. An external matching network is not required, but can be used for improved matching to a  $50\Omega$  source.

**V<sub>CC</sub>LO2 (Pin 15):** Power Supply Pin for the Mixer LO2 Circuits. This pin should be externally connected to the other  $V_{CC}$  pins and decoupled with 1000pF and 0.1 $\mu$ F capacitors.

**V<sub>CC</sub>VGA (Pin 16):** Power Supply Pin for the Modulator Variable Gain Amplifier. This pin should be externally connected to the other  $V_{CC}$  pins through a  $47\Omega$  resistor and decoupled with a good high frequency capacitor (2pF typical) placed close to the pin.

**MODOUT (Pin 17):** Modulator RF Output Pin. This pin must be externally biased to  $V_{CC}$  through a bias choke. An external matching network is required to match to  $50\Omega$ .

**GC2 (Pin 18):** Gain Control Pin. This pin is the most significant bit of the 4-step modulator gain control.

**BI<sup>+</sup> (Pin 19):** Positive Baseband Input Pin of the Modulator I-Channel. This pin is internally biased to 1.4V, but can also be overdriven with an external DC voltage greater than 1.4V, but less than  $V_{CC} - 0.4V$ .

**BI<sup>-</sup> (Pin 20):** Negative Baseband Input Pin of the Modulator I-Channel. This pin is internally biased to 1.4V, but can also be overdriven with an external DC voltage greater than 1.4V, but less than  $V_{CC} - 0.4V$ .

**Exposed Pad (Pin 21):** Circuit Ground Return for the Entire IC. This must be soldered to the printed circuit board ground plane.

**BLOCK DIAGRAM**

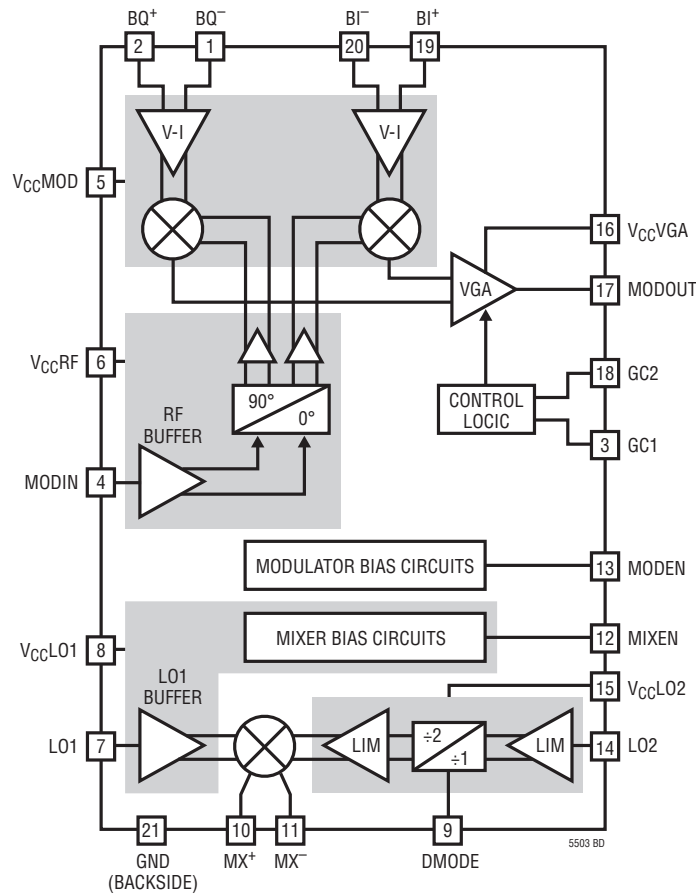

TEST CIRCUIT

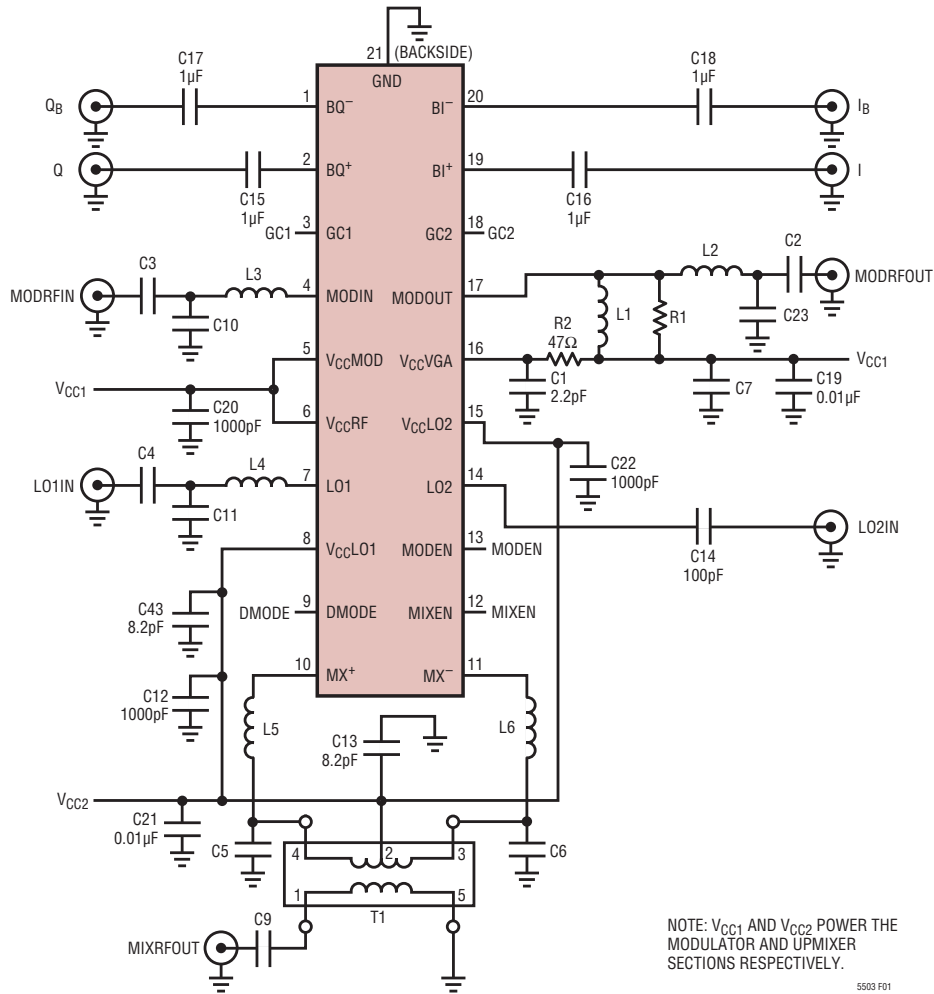

NOTE: V<sub>CC1</sub> AND V<sub>CC2</sub> POWER THE MODULATOR AND UPMIXER SECTIONS RESPECTIVELY.  
5503 F01

Application Dependent Component Values			
	1.2GHz Matching (Modulator Only)	1.9GHz Matching	2.4GHz Matching
L1	33nH	22nH	18nH
L2	12nH	5.6nH	2.7nH
L3	12nH	4.7nH	2.7nH
C2, C3, C7	39pF	15pF	8.2pF
C10	2.7pF	1.8pF	1.2pF
C23	n/a	1.5pF	1.5pF
R1	240Ω	390Ω	390Ω
C4	n/a	15pF	8.2pF
C5, C6	n/a	1.8pF	2.2pF
C9	n/a	15pF	2.7pF
C11	n/a	2.2pF	1.2pF
L4	n/a	6.8nH	4.7nH
L5, L6	n/a	5.6nH	2.2nH
T1	n/a	LDB211G9010C-001	LDB212G4005C-001

Figure 1. Test Schematic for 1.2GHz, 1.9GHz and 2.4GHz Applications



## APPLICATIONS INFORMATION

The LT5503 consists of a direct quadrature modulator and a mixer. The mixer operates over the range of 1.7GHz to 2.7GHz, and the modulator operates with an output range of 1.2GHz to 2.7GHz. The LT5503 is designed specifically for high accuracy digital modulation with supply voltages as low as 1.8V. It is suitable for IEEE 802.11b wireless local area network (WLAN), MMDS and wireless local loop (WLL) transmitters.

A dual-conversion RF system requires two local oscillators to convert signals between the baseband and RF domains (see Figure 2). The LT5503's double-balanced mixer can be used to generate the LT5503 modulator's high frequency carrier input (MODRFIN) by mixing the systems 1st and 2nd local oscillators (LO1 and LO2). In this case, a band-pass filter is required to select the desired mixer output for the modulator input. The mixer's RF differential output produces  $-12\text{dBm}$  typically at 2.45GHz and the modulator MODIN pin requires  $\geq -16\text{dBm}$ , driven single-ended. This allows approximately 4dB margin for bandpass filter

loss. The balanced output from the modulator is applied to a variable gain amplifier (VGA) that provides a single-ended output. Note that the modulator can also be used independently of the mixer, freeing the mixer to be used anywhere in the system. In this case, MODRFIN will be driven from an external frequency source.

### Modulator Baseband

The baseband I and Q inputs ( $BI^+/BI^-$  and  $BQ^+/BQ^-$ ) are internally biased to 1.4V to maximize the input signal range at low supply voltage. This bias voltage is stable over temperature, and increases by approximately 50mV at the maximum supply voltage. The modulator I and Q inputs have very wide bandwidth (120MHz typical), making the LT5503 suitable for even the most wideband modulation applications. For best carrier suppression and lowest distortion, differential input drive should be used. Single-ended drive is possible too, with the unused inputs AC-coupled to ground.

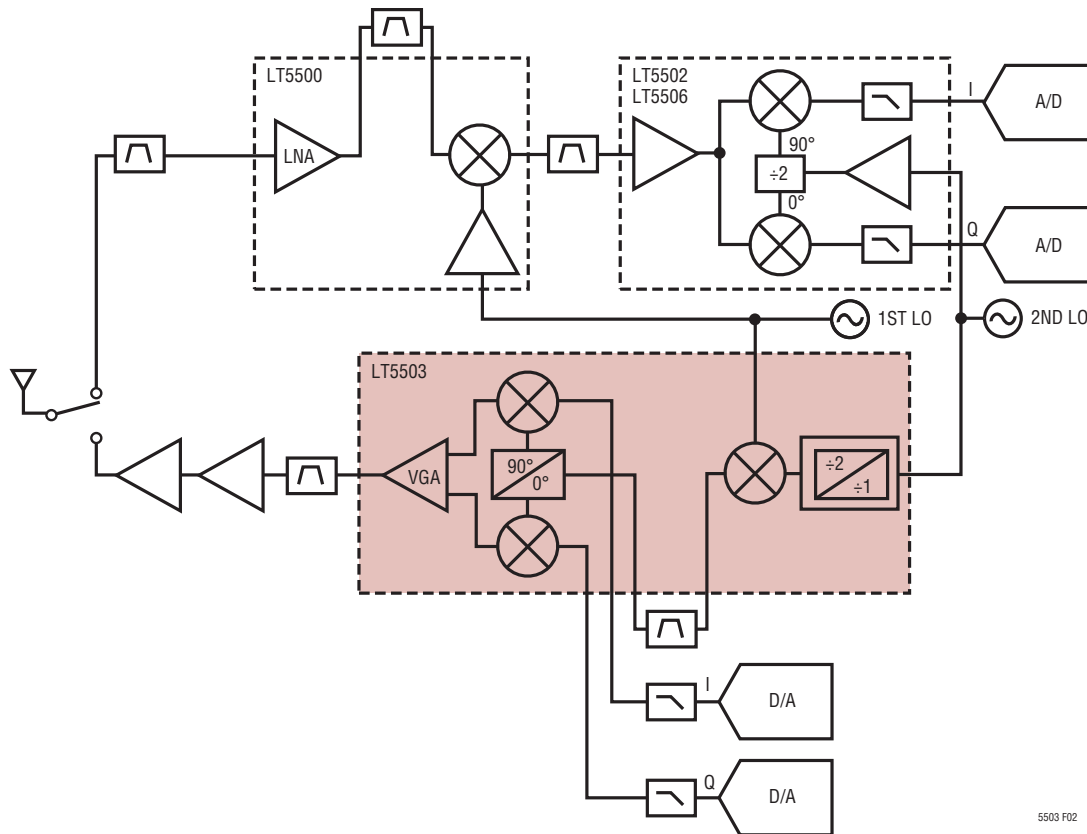
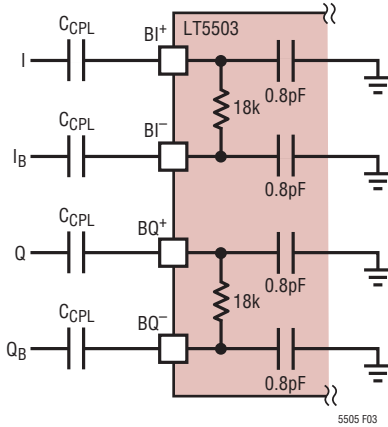

Figure 2. Example System Block Diagram for a Dual Conversion System

5503fa

## APPLICATIONS INFORMATION

**AC-Coupled Baseband.** Figure 3 shows the simplified circuit schematic of a high-pass AC-coupled baseband interface.



**Figure 3. AC-Coupled Baseband Interface**

With approximately 18k of differential input resistance, the suggested minimum AC-coupling capacitor can be determined using the following equation:

$$C_{CPL} = \frac{1}{(18 \cdot 10^3 \cdot \pi \cdot f_c)}$$

where  $f_c$  is the 3dB cut-off frequency of the baseband input signal.

A larger capacitor may be used where the settling time of charging and discharging the AC-coupling capacitor is not critical.

**DC-Coupled Baseband.** The baseband inputs' internal bias voltage can be overdriven with an external bias circuit. This facilitates direct interfacing to a D/A converter for faster transient response. In this case, the LT5503's baseband inputs are DC biased by the converter. The optimal  $V_{BIAS}$  is 1.4V, independent of  $V_{CC}$ . In general, the maximum  $V_{BIAS}$  should be less than  $V_{CC} - 0.4V$ . The DC load on each converter output can be approximated using the following equation where  $I_{INPUT}$  is the current flowing into a modulator input:

$$I_{INPUT} = \frac{V_{BIAS} - 1.4V}{9k\Omega}$$

Figure 4 shows a simplified circuit schematic for interfacing the LT5503's baseband inputs to the outputs of a D/A converter. OIP and OIN are the positive and negative baseband outputs, respectively, of the converter's I-channel. Similarly, OQP and OQN are the positive and negative baseband outputs, respectively, of the converter's Q-channel.

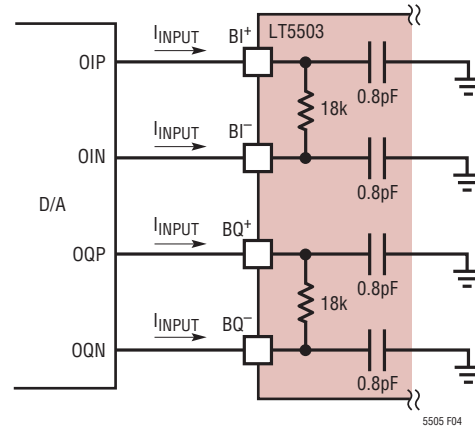

**Figure 4. DC-Coupled Baseband Interface**

### Modulator RF Input (MODRFIN)

The modulator RF input buffer is driven single ended. An internal active balun circuit produces balanced signals to drive the integrated phase shifter. Limiters following the phase shifter output accommodate a wide range of MODRFIN power, resulting in minimal degradation of modulation gain/phase accuracy performance or carrier feedthrough. This pin is easily matched to a 50Ω source with the simple lowpass network shown in Figure 1. This pin is internally biased, therefore an AC-coupling capacitor is required.

### Modulator VGA (Variable Gain Amp)

The VGA has two digital selection lines to provide a nominal 0dB, 4.5dB, 9dB and 13.5dB attenuation from the maximum modulator output power setting. The logic table is shown below:

ATTENUATION		GC2	
		LOW	HIGH
GC1	Low	0dB	9dB
	High	4.5dB	13.5dB

## APPLICATIONS INFORMATION

Pin 16 should be connected externally to  $V_{CC}$  through a low value series resistor (47 $\Omega$  typical). To assure proper output power control, a good, local high frequency AC ground for Pin 16 is essential. The MODOUT port of the VGA is an open collector configuration. An inductor with high self resonance frequency is required to connect Pin 17 to  $V_{CC}$  as a DC return path, and as a part of the output matching network. Additional matching components are required to drive a 50 $\Omega$  load as shown in Figure 1. The amplifier is designed to operate in Class A for low distortion performance. The typical output 1dB compression point (P1dB) is -3dBm at 2.45GHz. When the differential baseband input voltages are higher than 1V<sub>P-P</sub>, the VGA operates in Class AB mode, and the distortion performance of the modulator is degraded. The logic control inputs do not draw current when they are low. They draw about 2 $\mu$ A each when high.

### Mixer LO1 Port

The mixer LO1 input port is the linear input to the mixer. It consists of an active balun amplifier designed to operate over the 1.4GHz to 2.4GHz frequency range. There is a linear relationship between LO1 input power and MIXRFOUT power for LO1 input levels up to approximately -20dBm. After that, the mixer output begins to compress. When operated in the recommended -14dBm to -8dBm input power range, the mixer is well compressed, which in turn creates a stable output level for the modulator input. As shown in Figure 1, a simple lowpass matching network is required to match this pin to 50 $\Omega$ . This pin is internally biased, therefore an AC-coupling capacitor is required.

### Mixer LO2 Port

The mixer LO2 port is designed to operate in the 50MHz to 1000MHz range. The first stage is a limiting amplifier. This stage produces the correct output levels to drive the internal divider circuit reliably, with LO2 input levels down to -20dBm. The output of the divider then drives another stage, which in turn switches the nonlinear inputs of the double-balanced mixer. Note that the mixer output will produce broadband noise if the LO2 signal level is too low. The input amplifier is designed for a good match over the entire frequency range. The only requirement (Figure 1) is an external AC-coupling capacitor.

### Mixer Output Ports (MX<sup>+</sup>/MX<sup>-</sup>)

The mixer output is a differential open collector configuration. Bias current is supplied to these two pins through the center tap of a balun as shown in Figure 1. Simple lowpass matching is used to transform each leg of the mixer output to 25 $\Omega$  for the balun's 50 $\Omega$  input impedance.

The balun approach provides the highest output power and best LO1 suppression, but is not absolutely necessary. It is also possible to match each output to 50 $\Omega$  and couple power from one output. The unused output should be terminated in the same characteristic impedance. In this case, output power is approximately 2dB lower and LO1 suppression degrades to approximately 15dBc. A schematic for this approach is shown in Figure 6 where inductors LB<sup>+</sup> and LB<sup>-</sup> supply bias current to the mixer's differential outputs, and resistor R<sub>TERM</sub> terminates the unused output.

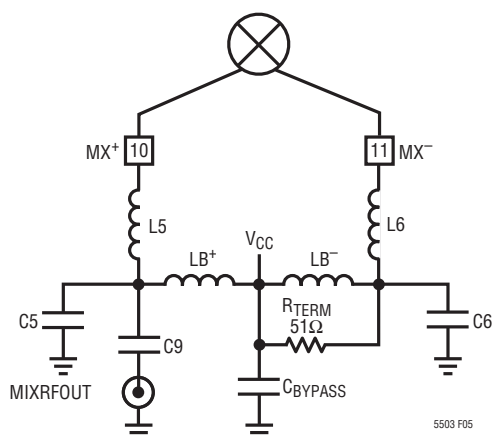

Figure 5. 50 $\Omega$  Mixer Output Matching Without a Balun

	1.9GHz	2.4GHz
L5,L6	5.6nH	2.7nH
C5, C6	1.8pF	0.68pF
C9	15pF	8.2pF

## APPLICATIONS INFORMATION

### EVALUATION BOARD

Figure 6 shows the circuit schematic of the evaluation board. The MODRFIN, MODRFOUT and MIXRFOUT ports are matched to 50Ω at 2.45GHz. The LO1IN port is matched to 50Ω at 2.1GHz and the LO2IN port is internally matched.

A 390Ω resistor is used to reduce the quality factor (Q) of the modulator output and deliver an output power of -3dBm typically. A lower value resistor may be used if the desired output power is lower. For example, the output power will be 3dB lower if a 200Ω resistor is used.

Inductors with high self-resonance frequency should be used for L1 to L6.

For simpler evaluation in a lab environment, the evaluation board includes op amps to convert single-ended I and Q input signals to differential. The op amp configuration has a voltage gain of two; therefore the peak baseband input voltage should be halved to maintain the same RF output power. The op amp configuration shown will maintain acceptable differential balance up to 10MHz typically. It is also possible to bypass the op amps and drive the modulator's differential inputs directly by connecting to the four oversized vias on the board (V1, V2, V3 and V4).

Figure 6 also shows a table of matching network values for designs centered at 1.9GHz and 1.2GHz.

Figure 7 shows the evaluation board with connectors and ICs. Figure 8 shows the test set-up with the upconverting mixer and IQ modulator connected in a transmit configuration. Refer to the demo board *DC365A Quick Start Guide* for detailed testing information.

### RF Layout Tips:

- Use 50Ω impedance transmission lines up to the matching networks, use of a ground plane is a must.
- Keep the matching networks as close to the pins as possible.
- Surface mount 0402 outline (or smaller) parts are recommended to minimize parasitic inductances and capacitances.
- Isolate the MODOUT pin from the LO2 input by putting the LO2 transmission line on the bottom side of the board.
- The only ground connection is through the exposed pad on the bottom of the package. This exposed pad must be soldered to the board in such a way to get complete RF contact.
- Low impedance RF ground connections are essential and can only be obtained by one or more vias tying directly into the ground plane.
- V<sub>CC</sub> lines must be decoupled with low impedance, broadband capacitors to prevent instability.
- Separate power supply lines should be used to isolate the MODIN signal and other stray signals from the MODOUT line. If possible, power planes should be used.
- Avoid use of long traces whenever possible. Long RF traces in particular can lead to signal radiation and degraded isolation, as well as higher losses.

APPLICATIONS INFORMATION

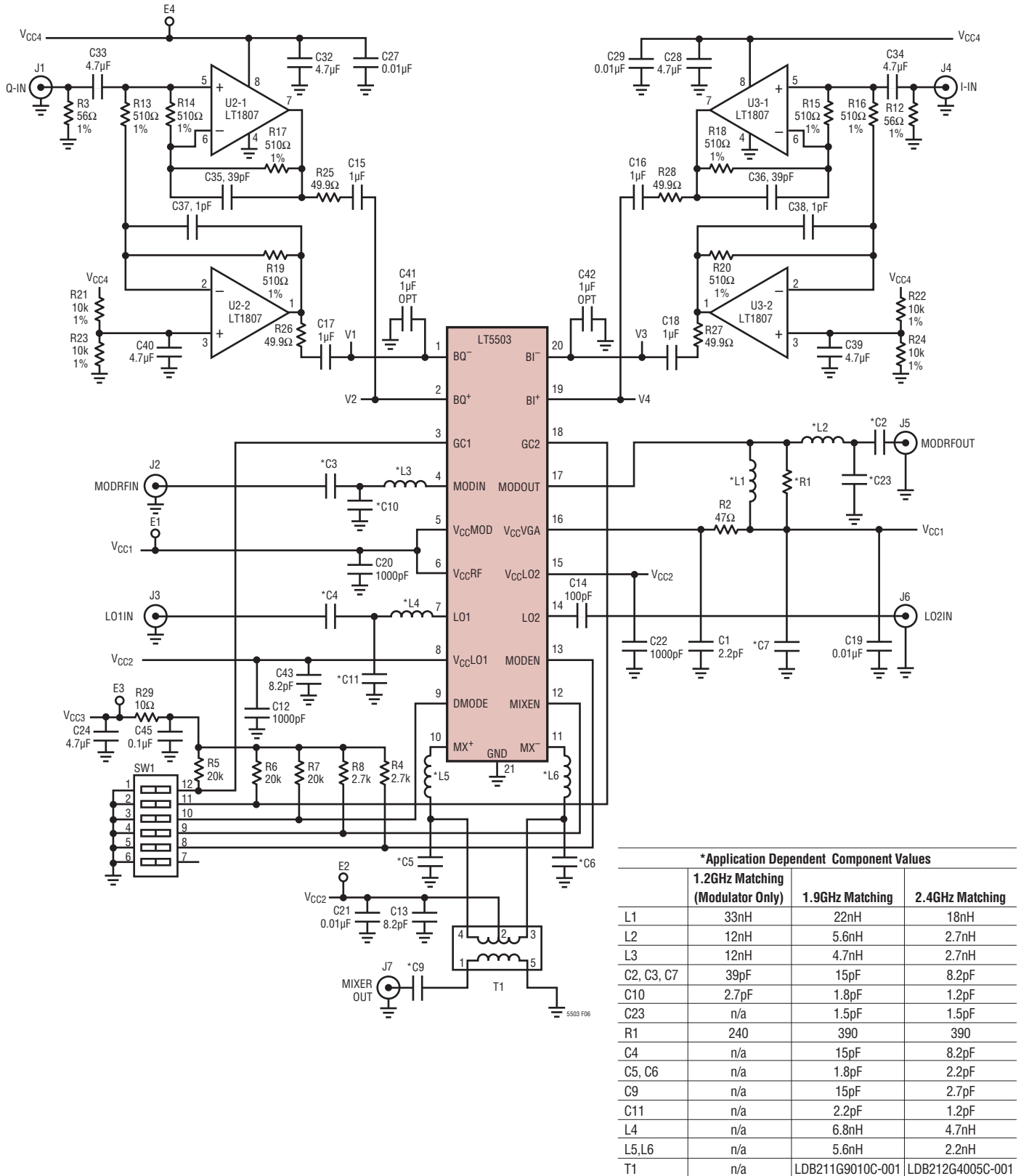

Figure 6. Evaluation Circuit Schematic for 1.2GHz, 1.9GHz and 2.4GHz Applications



APPLICATIONS INFORMATION

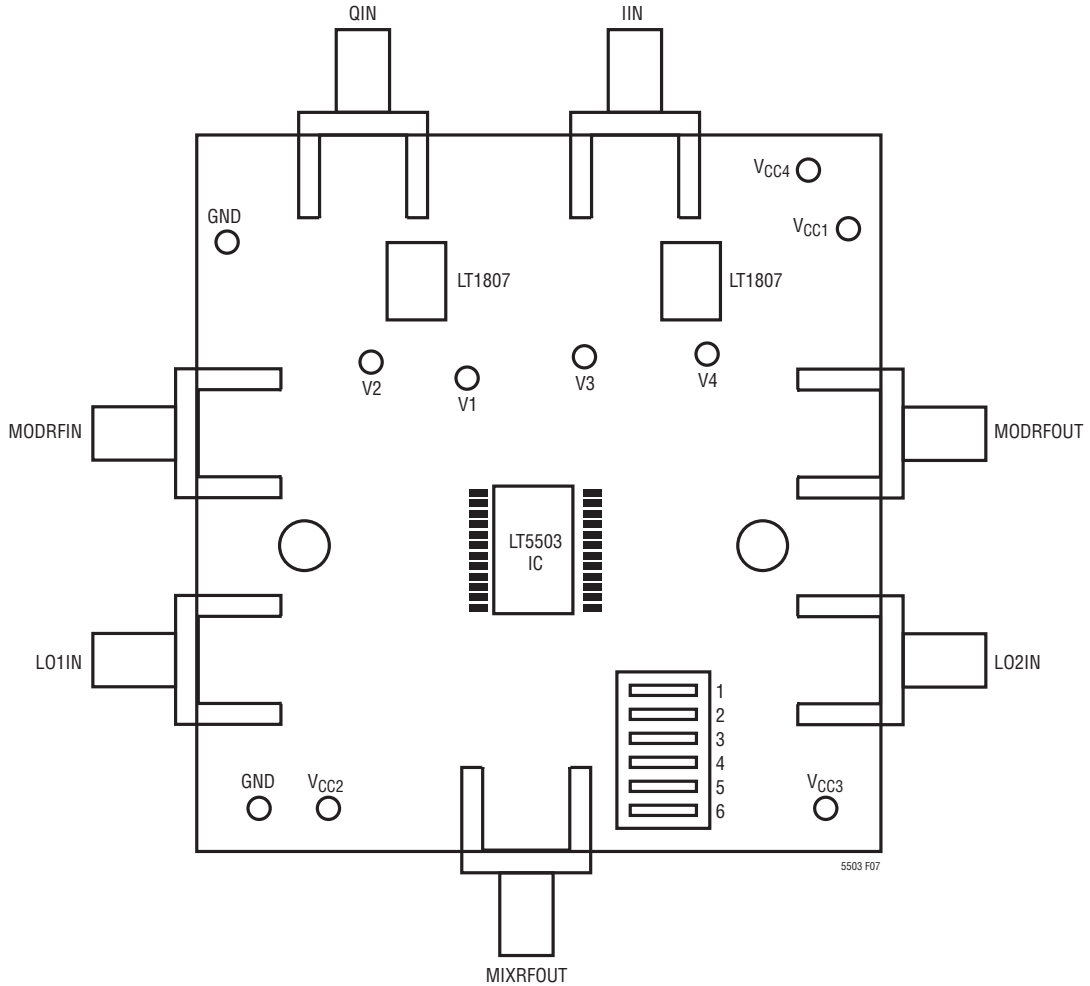
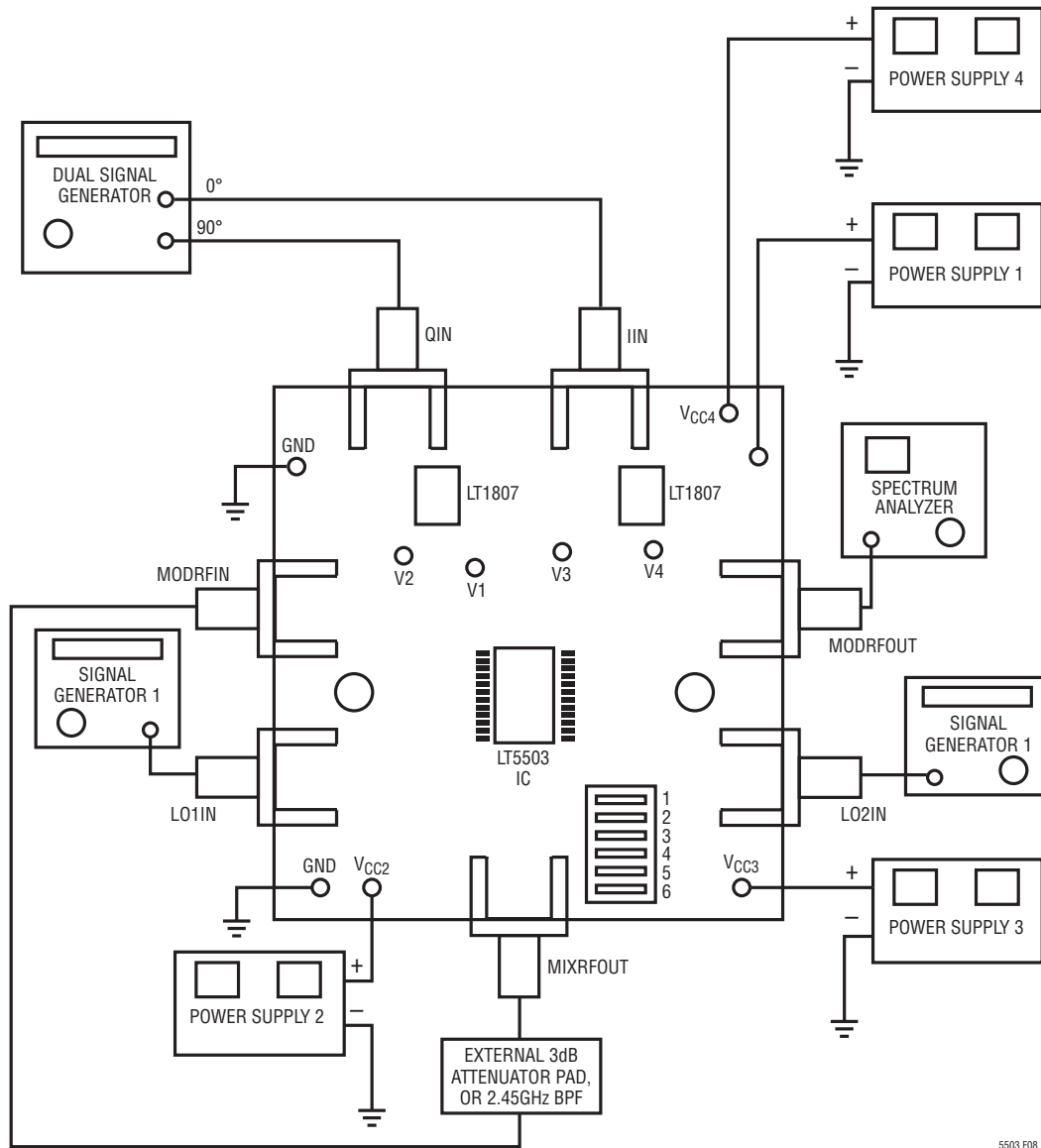

Figure 7. LT5503 Evaluation Board Layout

APPLICATIONS INFORMATION



5503 F08

Figure 8. Test Set-Up for Upconverting Mixer and I/Q Modulator Transmit Chain Measurements.

# PACKAGE DESCRIPTION

Please refer to <http://www.linear.com/designtools/packaging/> for the most recent package drawings.

**FE Package**  
**20-Lead Plastic TSSOP (4.4mm)**  
 (Reference LTC DWG # 05-08-1663 Rev K)  
**Exposed Pad Variation CB**

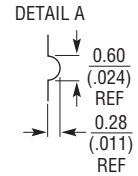
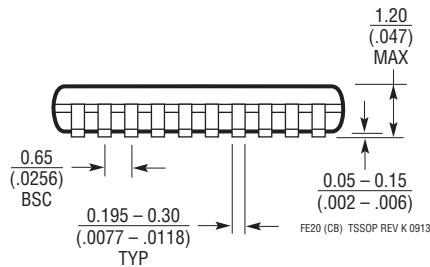
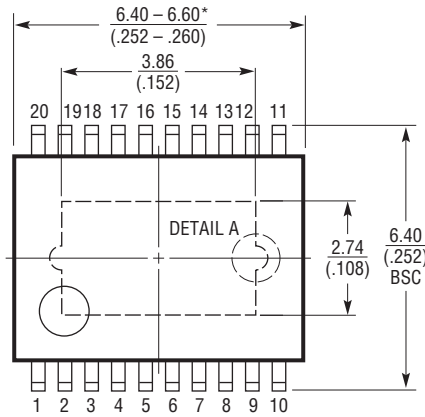
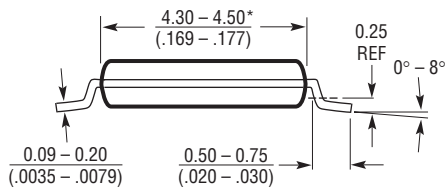
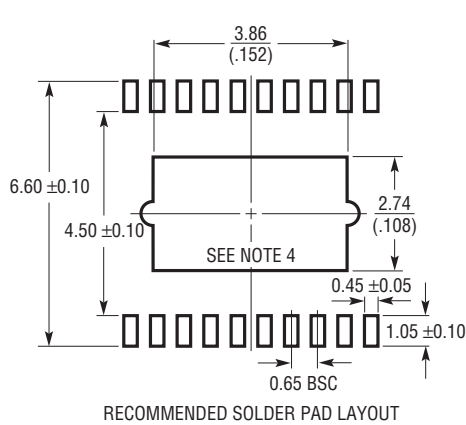

DETAIL A IS THE PART OF THE LEAD FRAME FEATURE FOR REFERENCE ONLY. NO MEASUREMENT PURPOSE.

**NOTE:**

1. CONTROLLING DIMENSION: MILLIMETERS
  2. DIMENSIONS ARE IN  $\frac{\text{MILLIMETERS}}{\text{INCHES}}$
  3. DRAWING NOT TO SCALE
  4. RECOMMENDED MINIMUM PCB METAL SIZE FOR EXPOSED PAD ATTACHMENT
- \*DIMENSIONS DO NOT INCLUDE MOLD FLASH. MOLD FLASH SHALL NOT EXCEED 0.150mm (.006") PER SIDE

## REVISION HISTORY

REV	DATE	DESCRIPTION	PAGE NUMBER
A	10/15	Obsolete Product	1, 2

## RELATED PARTS

PART NUMBER	DESCRIPTION	COMMENTS
<a href="#">LT5500</a>	RF Front End	Dual LNA Gain Setting +13.5dB/-14dB at 2.5GHz, Double-Balanced Mixer, $1.8V \leq V_{SUPPLY} \leq 5.25V$
<a href="#">LT5502</a>	400MHz Quadrature Demodulator with RSSI	1.8V to 5.25V Supply, 70MHz to 400MHz IF, 84dB Limiting Gain, 90dB RSSI Range
<a href="#">LT5504</a>	800MHz to 2.7GHz RF Measuring Receiver	80dB Dynamic Range, Temperature Compensated, 2.7V to 5.5V Supply
<a href="#">LTC5505</a>	300MHz to 3.5GHz RF Power Detector	>40dB Dynamic Range, Temperature Compensated, 2.7V to 6V Supply
<a href="#">LT5506</a>	500MHz Quadrature IF Demodulator with VGA	1.8V to 5.25V Supply, 40MHz to 500MHz IF, -4dB to 57dB Linear Power Gain
<a href="#">LTC<sup>®</sup>5507</a>	100kHz to 1GHz RF Power Detector	48dB Dynamic Range, Temperature Compensated, 2.7V to 6V Supply
<a href="#">LTC5508</a>	300MHz to 7GHz RF Power Detector	SC70 Package
<a href="#">LTC5509</a>	300MHz to 3GHz RF Power Detector	36dB Dynamic Range, SC70 Package
<a href="#">LT5511</a>	High Signal Level Up Converting Mixer	RF Output to 3GHz, 17dBm IIP3, Integrated LO Buffer
<a href="#">LT5512</a>	High Signal Level Down Converting Mixer	DC-3GHz, 20dBm IIP3, Integrated LO Buffer
<a href="#">LT5515</a>	1.5GHz to 2.5GHz Direct Conversion Demodulator	20dBm IIP3, Integrated LO Quadrature Generator
<a href="#">LT5516</a>	0.8GHz to 1.5GHz Direct Conversion Quadrature Demodulator	21.5dBm IIP3, Integrated LO Quadrature Generator
<a href="#">LT5522</a>	600MHz to 2.7GHz High Signal Level Mixer	25dBm IIP3 at 900MHz, 21.5dBm IIP3 at 1.9GHz, Matched 50Ω RF and LO Ports, Integrated LO Buffer
<a href="#">LTC5532</a>	300MHz to 7GHz Precision RF Power Detector	Precision $V_{OUT}$ Offset Control, Adjustable Gain and Offset Voltage