



Chipsmall Limited consists of a professional team with an average of over 10 year of expertise in the distribution of electronic components. Based in Hongkong, we have already established firm and mutual-benefit business relationships with customers from,Europe,America and south Asia,supplying obsolete and hard-to-find components to meet their specific needs.

With the principle of “Quality Parts,Customers Priority,Honest Operation,and Considerate Service”,our business mainly focus on the distribution of electronic components. Line cards we deal with include Microchip,ALPS,ROHM,Xilinx,Pulse,ON,Everlight and Freescale. Main products comprise IC,Modules,Potentiometer,IC Socket,Relay,Connector.Our parts cover such applications as commercial,industrial, and automotives areas.

We are looking forward to setting up business relationship with you and hope to provide you with the best service and solution. Let us make a better world for our industry!



## Contact us

Tel: +86-755-8981 8866 Fax: +86-755-8427 6832

Email & Skype: info@chipsmall.com Web: www.chipsmall.com

Address: A1208, Overseas Decoration Building, #122 Zhenhua RD., Futian, Shenzhen, China



**LED DISPLAY****LTC-2621CB  
DATASHEET**

<u>Rev</u>	<u>Description</u>	<u>By</u>
01	ORIGINAL	<u>Anon b.</u> May-23'13

SPEC. NO.: \_\_\_\_\_

DATE : May-23'13

REV. NO. : \_\_\_\_\_

PAGE NO. : 1 OF 7

**FEATURES**

- \* 0.28 inch (7.0 mm) DIGIT HEIGHT.
- \* CONTINUOUS UNIFORM SEGMENTS.
- \* LOW POWER REQUIREMENT.
- \* EXCELLENT CHARACTERS APPEARANCE.
- \* HIGH BRIGHTNESS & HIGH CONTRAST.
- \* WIDE VIEWING ANGLE.
- \* SOLID STATE RELIABILITY.
- \* CATEGORIZED FOR LUMINOUS INTENSITY.
- \* **LEAD-FREE PACKAGE (ACCORDING TO ROHS)**

**DESCRIPTION**

The LTC-2621CB is a 0.28 inch (7.0 mm) digit height triple digit seven-segment display. This device InGaN blue LED chips (GaN epi on SiC substrate) and has a gray face and white segments.

**DEVICE**

<b>PART NO.</b>	<b>DESCRIPTION</b>
InGaN BLUE	Multiplex Common Anode Rt.Hand Decimal
LTC-2621CB	

## PACKAGE DIMENSIONS

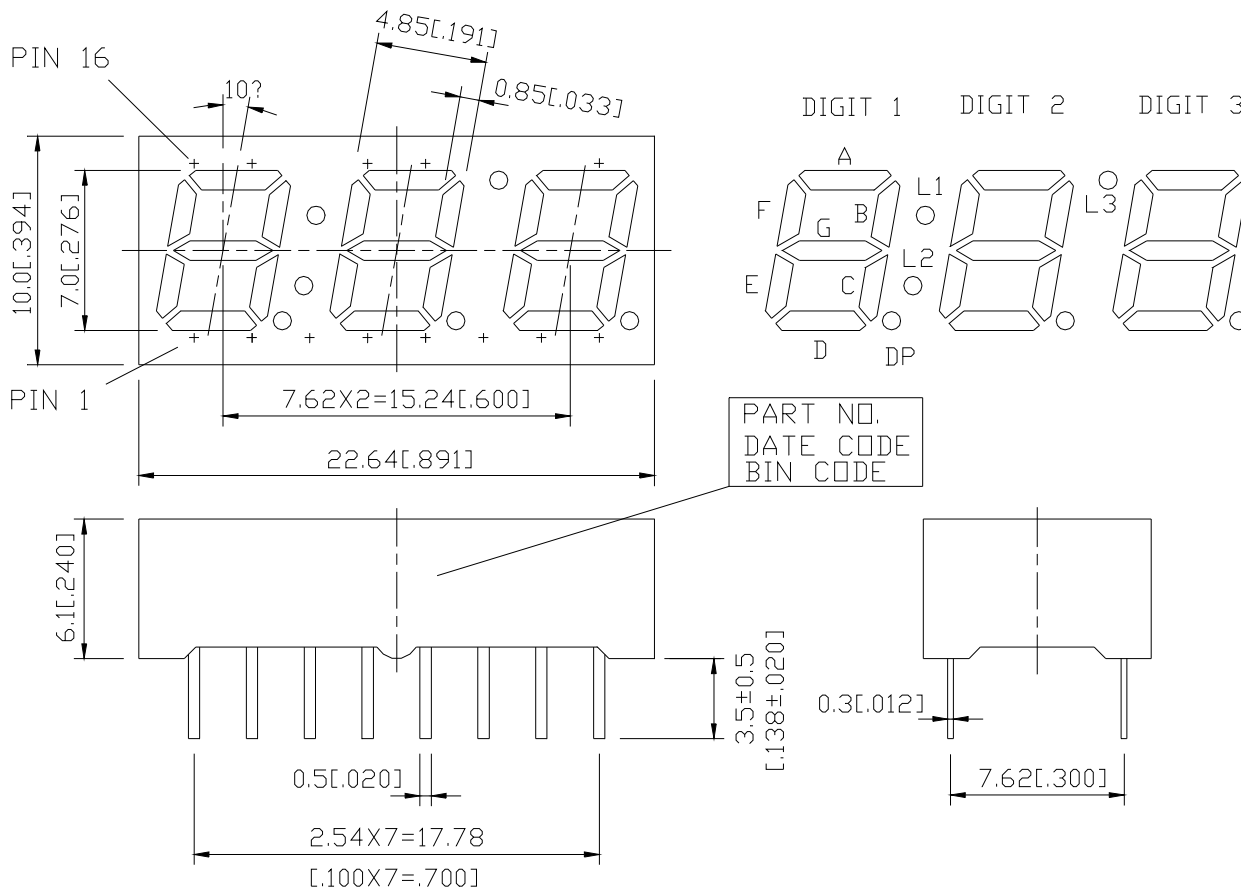

- NOTES:
1. All dimensions are in millimeters. Tolerances are  $\pm 0.25$  mm (0.01") unless otherwise noted.
  2. Pin tip's shift tolerances are  $\pm 0.40$  mm.
  3. Bending  $\cong 0.23$  mm.
  4. Foreign material on segment  $\cong 10$  mils
  5. Bubble in segment  $\cong 10$  mils
  6. Ink contamination (on surface)  $\cong 20$  mils

## INTERNAL CIRCUIT DIAGRAM

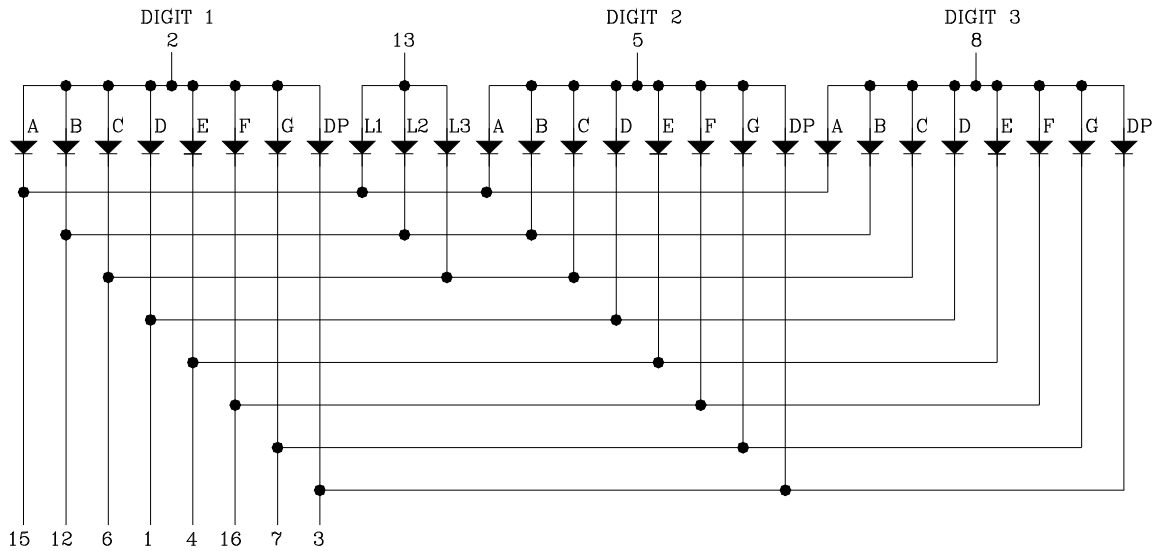
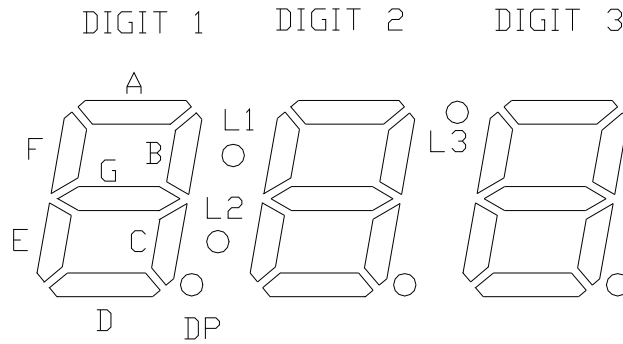

**PIN CONNECTION**

NO	CONNECTION
1	ANODE D
2	COMMON CATHODE DIGIT 1
3	ANODE DP
4	ANODE E
5	COMMON CATHODE DIGIT 2
6	ANODE C
7	ANODE G
8	COMMON CATHODE DIGIT 3
9	NO CONNECTION
10	NO PIN
11	NO PIN
12	ANODE B
13	COMMON CATHODE L1,L2,L3
14	NO PIN
15	ANODE A
16	ANODE F

**ABSOLUTE MAXIMUM RATING AT Ta=25°C**

PARAMETER	MAXIMUM RATING	UNIT
Power Dissipation Per Segment	115	mW
Peak Forward Current Per Segment ( Frequency 1Khz, 10% duty cycle)	100	mA
Continuous Forward Current Per Segment	25	mA
Forward Current Durlating from 25 <sup>0</sup> C	0.28	mA/ <sup>0</sup> C
Operating Temperature Range	-35 <sup>0</sup> C to +105 <sup>0</sup> C	
Storage Temperature Range	-35 <sup>0</sup> C to +105 <sup>0</sup> C	

Soldering Conditions: 1/16 inch below seating plane for 5 seconds at 260<sup>0</sup>C., or temperature of unit (during assembly) not over max. temperature rating above

**ELECTRICAL / OPTICAL CHARACTERISTICS AT Ta=25°C**

PARAMETER	SYMBOL	MIN	TYP	MAX	UNIT	TEST CONDITION
Average Luminous Intensity Per Segment	I <sub>v</sub>	800	2600		μcd	I <sub>F</sub> = 10mA
Peak Emission Wavelength	λ <sub>p</sub>		468		nm	I <sub>F</sub> = 20mA
Spectral Line Half-Width	Δλ		25		nm	I <sub>F</sub> = 20mA
Dominant Wavelength	λ <sub>d</sub>		470		nm	I <sub>F</sub> = 20mA
Forward Voltage Per Segment	V <sub>F</sub>		3.3	3.5	V	I <sub>F</sub> = 20mA
Reverse Current Per Segment	I <sub>R</sub>			100	μA	V <sub>R</sub> = 5V
Luminous Intensity Matching Ratio (Similar Light Area)	I <sub>v</sub> -m			2 : 1		I <sub>F</sub> = 10mA

Note: 1.Luminous intensity is measured with a light sensor and filter combination that approximates the CIE (Commision Internationale De L'Eclairage) eye-response curve.

2. Cross talk specification <=1%

3. Reverse voltage is only for IR test. It can not continue to operate at this situation.

**TYPICAL ELECTRICAL / OPTICAL CHARACTERISTIC CURVES**

(25°C Ambient Temperature Unless Otherwise Noted)

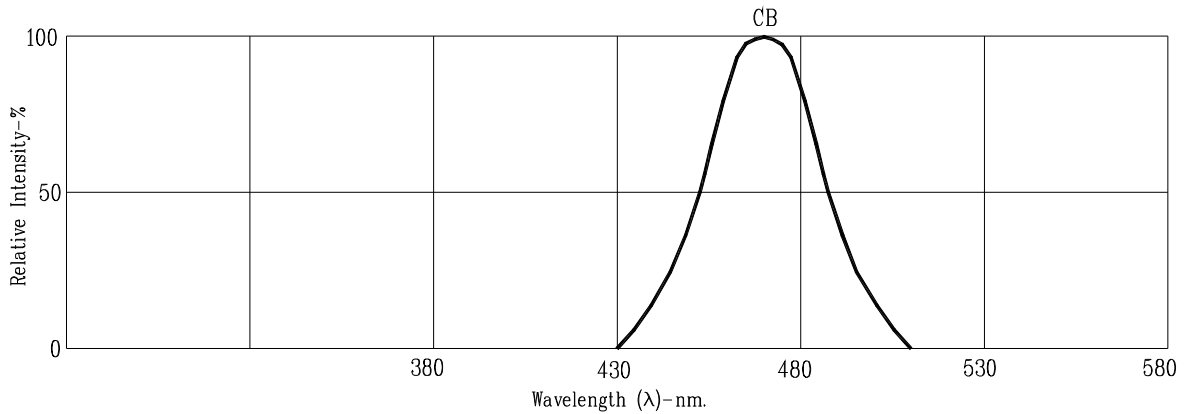

Fig1. RELATIVE INTENSITY VS. WAVELENGTH

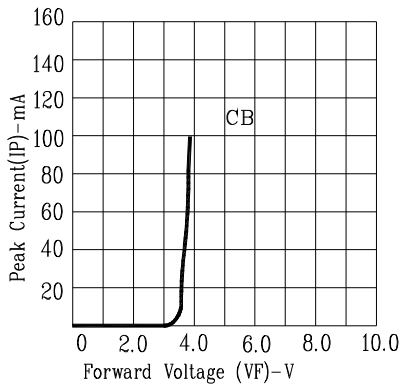

Fig3. FORWARD CURRENT VS. FORWARD VOLTAGE

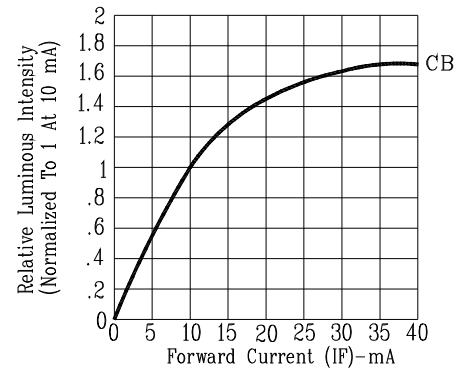

Fig4. RELATIVE LUMINOUS INTENSITY VS. FORWARD CURRENT

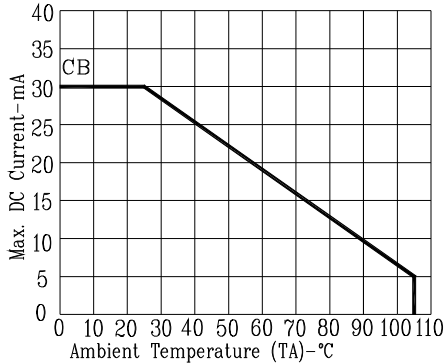

Fig5. MAX. ALLOWABLE DC CURRENT VS. AMBIENT TEMPERATURE.

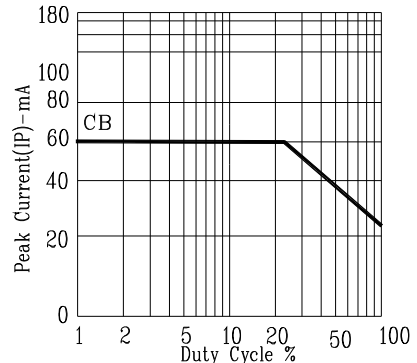

Fig6. MAX. PEAK CURRENT VS. DUTY CYCLE % (REFRESH RATE 1KHz)

NOTE: CB=InGaN Blue