



Chipsmall Limited consists of a professional team with an average of over 10 year of expertise in the distribution of electronic components. Based in Hongkong, we have already established firm and mutual-benefit business relationships with customers from,Europe,America and south Asia,supplying obsolete and hard-to-find components to meet their specific needs.

With the principle of “Quality Parts,Customers Priority,Honest Operation,and Considerate Service”,our business mainly focus on the distribution of electronic components. Line cards we deal with include Microchip,ALPS,ROHM,Xilinx,Pulse,ON,Everlight and Freescale. Main products comprise IC,Modules,Potentiometer,IC Socket,Relay,Connector.Our parts cover such applications as commercial,industrial, and automotives areas.

We are looking forward to setting up business relationship with you and hope to provide you with the best service and solution. Let us make a better world for our industry!



## Contact us

Tel: +86-755-8981 8866 Fax: +86-755-8427 6832

Email & Skype: info@chipsmall.com Web: www.chipsmall.com

Address: A1208, Overseas Decoration Building, #122 Zhenhua RD., Futian, Shenzhen, China



## FEATURES

- True RS485 from a Single 3.3V Supply
- Low Power:  $I_{CC} = 500\mu\text{A}$  Max with Driver Disabled
- $I_{CC} = 600\mu\text{A}$  Max with Driver Enabled, No Load
- $1\mu\text{A}$  Quiescent in Shutdown Mode
- $-7\text{V}$  to  $12\text{V}$  Common Mode Range Permits  $\pm 7\text{V}$  Ground Difference Between Devices on the Data Line
- Thermal Shutdown Protection
- Power Up/Down Glitch-Free Driver Outputs Permit Live Insertion or Removal of Transceiver
- Driver Maintains High Impedance in Three-State or with the Power Off
- Up to 32 Transceivers on the Bus
- 50ns Typical Driver Propagation Delays with 10ns Skew
- Pin Compatible with the LTC485
- Available in 8-Lead DIP and SO Packages

## APPLICATIONS

- Battery-Powered RS485/RS422 Applications
- Low Power RS485/RS422 Transceiver
- Level Translator

## DESCRIPTION

The LTC<sup>®</sup>1480 is an ultralow power differential line transceiver which provides full RS485 compatibility while operating from a single 3.3V supply. It is designed for data transmission standard RS485 applications with extended common mode range ( $12\text{V}$  to  $-7\text{V}$ ). It also meets the requirements of RS422 and features high speed operation up to 2.5Mb/s. The CMOS design offers significant power savings without sacrificing ruggedness against overload or ESD damage. Typical quiescent current is only  $300\mu\text{A}$  while operating and  $1\mu\text{A}$  in shutdown.

The driver and receiver feature three-state outputs, with the driver outputs maintaining high impedance over the entire common mode range. Excessive power dissipation caused by bus contention or faults is prevented by a thermal shutdown circuit which forces the driver outputs into a high impedance state. The receiver has a fail-safe feature which guarantees a high output state when the inputs are left open.

The LTC1480 is fully specified over the commercial and extended industrial temperature range. The LTC1480 is available in 8-pin SO and DIP packages.

LT, LTC and LT are registered trademarks of Linear Technology Corporation. All other trademarks are the property of their respective owners.

## TYPICAL APPLICATION

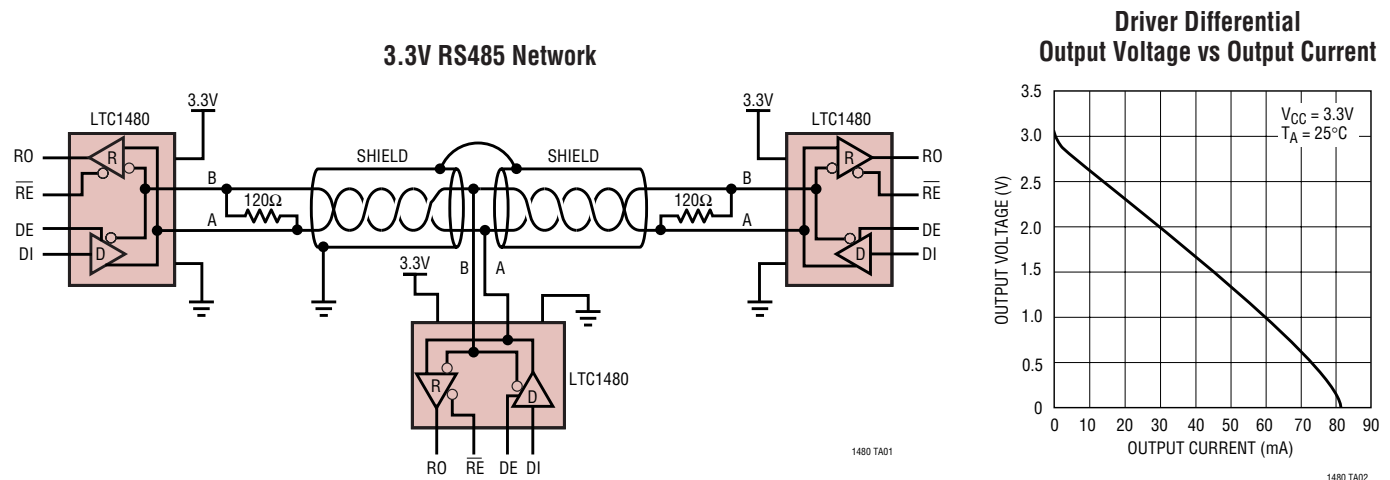

# LTC1480

## ABSOLUTE MAXIMUM RATINGS

(Note 1)

Supply Voltage ( $V_{CC}$ )	7V
Control Input Voltage	-0.3V to $V_{CC} + 0.3V$
Driver Input Voltage	-0.3V to $V_{CC} + 0.3V$
Driver Output Voltage	$\pm 14V$
Receiver Input Voltage	$\pm 14V$
Receiver Output Voltage	-0.3V to $V_{CC} + 0.3V$
Operating Temperature Range	
LTC1480C	$0^{\circ}C \leq T_A \leq 70^{\circ}C$
LTC1480I	$-40^{\circ}C \leq T_A \leq 85^{\circ}C$
Storage Temperature Range	$-65^{\circ}C$ to $150^{\circ}C$
Lead Temperature (Soldering, 10 sec)	$300^{\circ}C$

## PACKAGE/ORDER INFORMATION

N8 PACKAGE 8-LEAD PDIP	S8 PACKAGE 8-LEAD PLASTIC SO
$T_{JMAX} = 125^{\circ}C, \theta_{JA} = 130^{\circ}C/W$ (N8) $T_{JMAX} = 125^{\circ}C, \theta_{JA} = 150^{\circ}C/W$ (S8)	
ORDER PART NUMBER	S8 PART MARKING
LTC1480CN8	1480
LTC1480IN8	1480I
LTC1480CS8	
LTC1480IS8	
<b>Order Options</b> Tape and Reel: Add #TR Lead Free: Add #PBF    Lead Free Tape and Reel: Add #TRPBF Lead Free Part Marking: <a href="http://www.linear.com/leadfree/">http://www.linear.com/leadfree/</a>	

Consult LTC Marketing for parts specified with wider operating temperature ranges.

## ELECTRICAL CHARACTERISTICS

The ● denotes the specifications which apply over the full operating temperature range.  $V_{CC} = 3.3V$  (Notes 2, 3).

SYMBOL	PARAMETER	CONDITIONS	MIN	TYP	MAX	UNITS
$V_{OD1}$	Differential Driver Output Voltage (Unloaded)	$I_O = 0V$	●		3.3	V
$V_{OD2}$	Differential Driver Output Voltage (with Load)	$R = 27\Omega$ (RS485) (Figure 1) $R = 50\Omega$ (RS422)	● ●	1.5 2.0	3.3	V V
$\Delta V_{OD}$	Change in Magnitude of Driver Differential Output Voltage for Complementary Output States	$R = 27\Omega$ or $R = 50\Omega$ (Figure 1)	●		0.2	V
$V_{OC}$	Driver Common Mode Output Voltage	$R = 27\Omega$ or $R = 50\Omega$ (Figure 1)	●		2	V
$\Delta  V_{OC} $	Change in Magnitude of Driver Common Mode Output Voltage for Complementary Output States	$R = 27\Omega$ or $R = 50\Omega$ (Figure 1)	●		0.2	V
$V_{IH}$	Input HIGH Voltage	DE, DI, $\overline{RE}$	●	2		V
$V_{IL}$	Input LOW Voltage	DE, DI, $\overline{RE}$	●		0.8	V
$I_{IN1}$	Input Current	DE, DI, $\overline{RE}$	●		$\pm 2$	$\mu A$
$I_{IN2}$	Input Current (A, B)	DE = 0, $V_{CC} = 0V$ or $3.6V$ , $V_{IN} = 12V$ DE = 0, $V_{CC} = 0V$ or $3.6V$ , $V_{IN} = -7V$	● ●		1.0 -0.8	$mA$ $mA$
$V_{TH}$	Differential Input Threshold Voltage for Receiver	$-7V \leq V_{CM} \leq 12V$	●	-0.2	0.2	V
$\Delta V_{TH}$	Receiver Input Hysteresis	$V_{CM} = 0V$		70		mV
$V_{OH}$	Receiver Output HIGH Voltage	$I_O = -4mA$ , $V_{ID} = 200mV$	●	2		V
$V_{OL}$	Receiver Output LOW Voltage	$I_O = 4mA$ , $V_{ID} = -200mV$	●		0.4	V
$I_{OZR}$	Three-State (High Impedance) Output Current at Receiver	$V_{CC} = Max$ , $0.4V \leq V_O \leq 2.4V$	●		$\pm 1$	$\mu A$
$R_{IN}$	Receiver Input Resistance	$-7V \leq V_{CM} \leq 12V$	●	12		$k\Omega$
$I_{CC}$	Supply Current	No Load, Output Enabled No Load, Output Disabled	● ●	400 300	600 500	$\mu A$ $\mu A$
$I_{SHDN}$	Supply Current in Shutdown Mode	DE = 0, $\overline{RE} = V_{CC}$		1	10	$\mu A$

1480fa

## SWITCHING CHARACTERISTICS

The ● denotes the specifications which apply over the full operating temperature range.  $V_{CC} = 3.3V$  (Notes 2, 3).

SYMBOL	PARAMETER	CONDITIONS	MIN	TYP	MAX	UNITS
$I_{OSD1}$	Driver Short-Circuit Current, $V_{OUT} = HIGH$	$-7V \leq V_O \leq 12V$	● 35		250	mA
$I_{OSD2}$	Driver Short-Circuit Current, $V_{OUT} = LOW$	$-7V \leq V_O \leq 12V$	● 35		250	mA
$I_{OSR}$	Receiver Short-Circuit Current	$0V \leq V_O \leq V_{CC}$	● 7		85	mA
$t_{PLH}$	Driver Input to Output	$R_{DIFF} = 54\Omega$ , $C_{L1} = C_{L2} = 100pF$ , (Figures 3, 5)	● 25	50	80	ns
$t_{PHL}$	Driver Input to Output		● 25	50	80	ns
$t_{SKEW}$	Driver Output to Output		●	10	20	ns
$t_R, t_F$	Driver Rise or Fall Time		● 5	15	40	ns
$t_{ZH}$	Driver Enable to Output HIGH	$C_L = 100pF$ (Figures 4, 6), S2 Closed	●	70	120	ns
$t_{ZL}$	Driver Enable to Output LOW	$C_L = 100pF$ (Figures 4, 6), S1 Closed	●	70	120	ns
$t_{LZ}$	Driver Disable Time from LOW	$C_L = 15pF$ (Figures 4, 6), S1 Closed	●	70	120	ns
$t_{HZ}$	Driver Disable Time from HIGH	$C_L = 15pF$ (Figures 4, 6), S2 Closed	●	70	120	ns
$t_{PLH}$	Receiver Input to Output	$R_{DIFF} = 54\Omega$ , $C_{L1} = C_{L2} = 100pF$ , (Figures 3, 7)	● 30	140	200	ns
$t_{PHL}$	Receiver Input to Output		● 30	140	200	ns
$t_{SKD}$	$ t_{PLH} - t_{PHL} $ Differential Receiver Skew			13		ns
$t_{ZL}$	Receiver Enable to Output LOW	$C_{RL} = 15pF$ (Figures 2, 8), S1 Closed	●	50	80	ns
$t_{ZH}$	Receiver Enable to Output HIGH	$C_{RL} = 15pF$ (Figures 2, 8), S2 Closed	●	50	80	ns
$t_{LZ}$	Receiver Disable from LOW	$C_{RL} = 15pF$ (Figures 2, 8), S1 Closed	●	50	80	ns
$t_{HZ}$	Receiver Disable from HIGH	$C_{RL} = 15pF$ (Figures 2, 8), S2 Closed	●	50	80	ns
$f_{MAX}$	Maximum Data Rate		● 2.5			Mbits/s
$t_{SHDN}$	Time to Shutdown	DE = 0, RE = $\uparrow$	● 50	200	600	ns
$t_{ZH}(SHDN)$	Driver Enable from Shutdown to Output HIGH	$C_L = 100pF$ (Figures 4, 6), S2 Closed	●	70	120	ns
$t_{ZL}(SHDN)$	Driver Enable from Shutdown to Output LOW	$C_L = 100pF$ (Figures 4, 6), S1 Closed	●	70	120	ns
$t_{ZH}(SHDN)$	Receiver Enable from Shutdown to Output HIGH	$C_L = 15pF$ (Figures 2, 8), S2 Closed	●		4500	ns
$t_{ZL}(SHDN)$	Receiver Enable from Shutdown to Output LOW	$C_L = 15pF$ (Figures 2, 8), S1 Closed	●		4500	ns

**Note 1:** Absolute maximum ratings are those beyond which the safety of the device cannot be guaranteed.

**Note 2:** All currents into device pins are positive; all currents out of device pins are negative. All voltages are referenced to device ground unless otherwise specified.

**Note 3:** All typicals are given for  $V_{CC} = 3.3V$  and  $T_A = 25^\circ C$ .

## TYPICAL PERFORMANCE CHARACTERISTICS

Supply Current vs Temperature

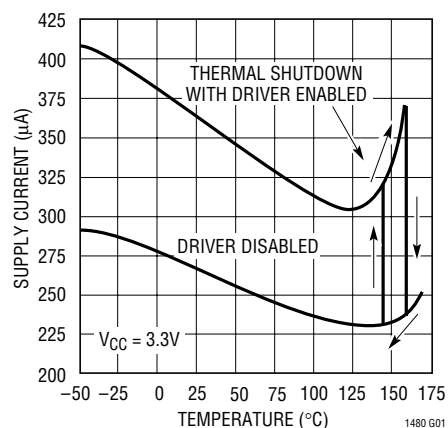

Driver Output Low/High Voltage vs Output Current

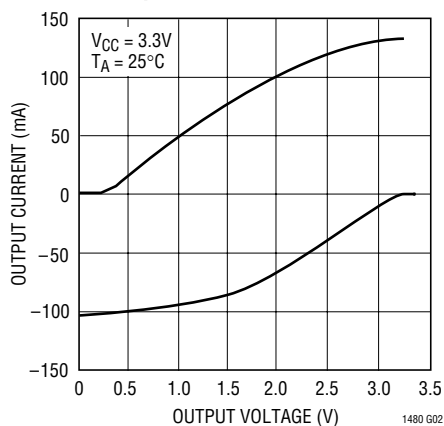

Driver Differential Output Voltage vs Temperature

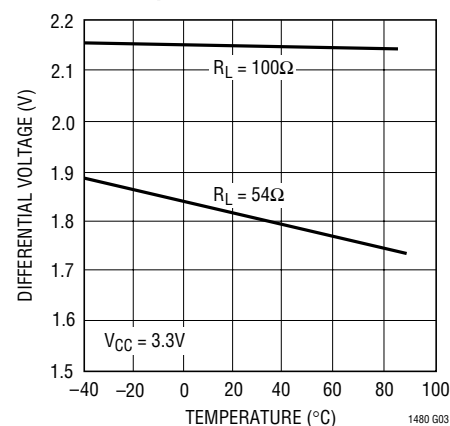

## TYPICAL PERFORMANCE CHARACTERISTICS

Driver Skew vs Temperature

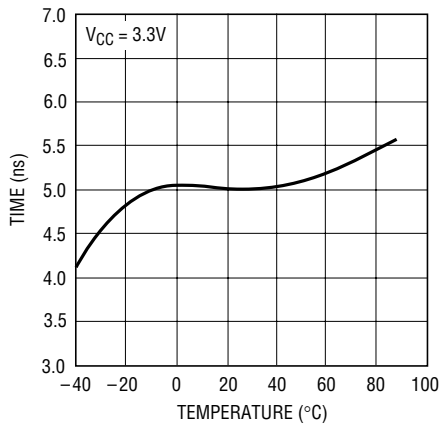

1480 G04

Receiver Output Low Voltage vs Output Current

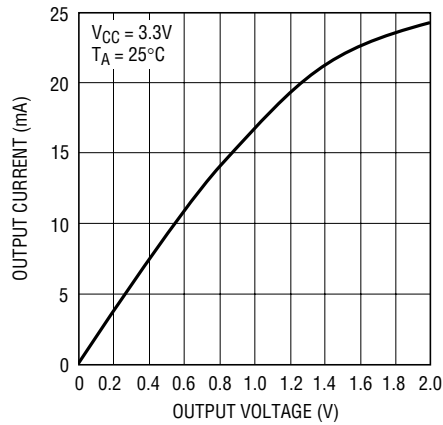

1480 G05

Receiver Output High Voltage vs Output Current

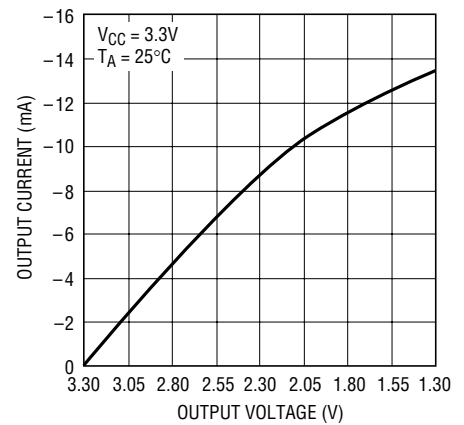

1480 G06

Receiver  $|t_{PLH} - t_{PHL}|$  vs Temperature

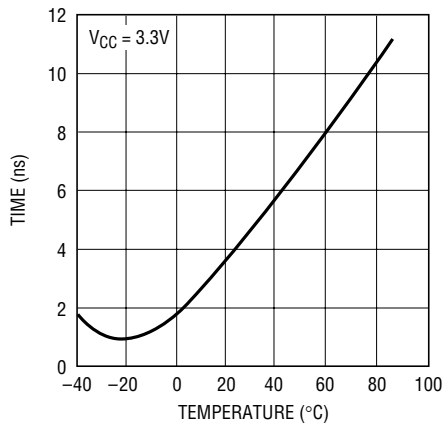

1480 G07

Receiver Output Low Voltage vs Temperature

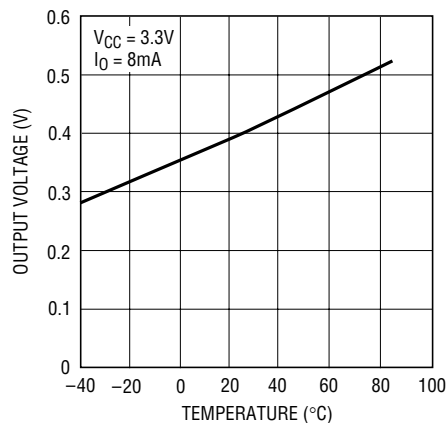

1480 G08

Receiver Output High Voltage vs Temperature

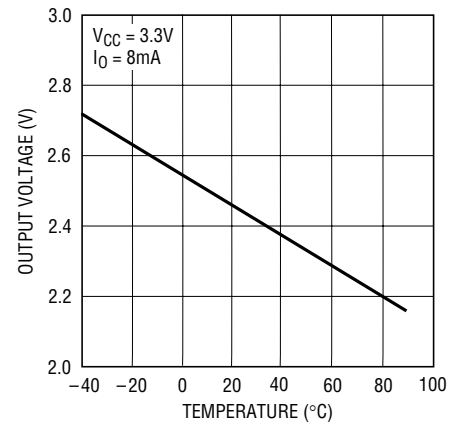

1480 G09

## PIN FUNCTIONS

**RO (Pin 1):** Receiver Output. If the receiver output is enabled ( $\overline{RE}$  LOW) and  $A > B$  by 200mV, then RO will be HIGH. If  $A < B$  by 200mV, then RO will be LOW.

**RE (Pin 2):** Receiver Output Enable. A LOW enables the receiver output, RO. A HIGH input forces the receiver output into a high impedance state.

**DE (Pin 3):** Driver Outputs Enable. A HIGH on DE enables the driver output. A, B and the chip will function as a line driver. A low input will force the driver outputs into a high impedance state and the chip will function as a line receiver. If  $\overline{RE}$  is high and DE is LOW, the part will enter a low power ( $1\mu A$ ) shutdown state. If  $\overline{RE}$  is low and DE is

high, the driver outputs will be fed back to the receiver and the receive output will correspond to the driver input.

**DI (Pin 4):** Driver Input. If the driver outputs are enabled (DE HIGH) then a low on DI forces the outputs A LOW and B HIGH. A HIGH on DI with the driver outputs enabled will force A HIGH and B LOW.

**GND (Pin 5):** Ground.

**A (Pin 6):** Driver Output/Receiver Input.

**B (Pin 7):** Driver Output/Receiver Input.

**VCC (Pin 8):** Positive Supply.  $3.0V < V_{CC} < 3.6V$ .

## FUNCTION TABLES

LTC1480 Transmitting

INPUTS			OUTPUTS	
$\overline{RE}$	DE	DI	B	A
X	1	1	0	1
X	1	0	1	0
0	0	X	Z	Z
1	0	X	Z*	Z*

\*Shutdown mode

LTC1480 Receiving

INPUTS			OUTPUTS
$\overline{RE}$	DE	A - B	RO
0	0	$\geq 0.2V$	1
0	0	$\leq -0.2V$	0
0	0	Inputs Open	1
1	0	X	Z*

\*Shutdown mode

## TEST CIRCUITS

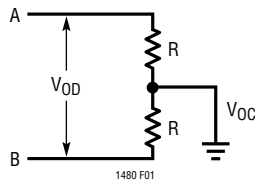

Figure 1. Driver DC Test Load

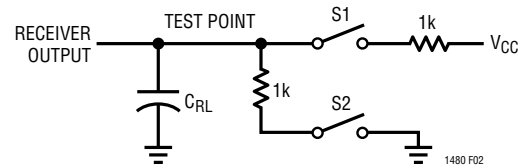

Figure 2. Receiver Timing Test Load

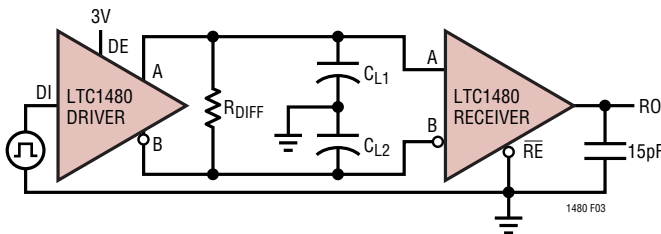

Figure 3. Driver/Receiver Timing Test Circuit

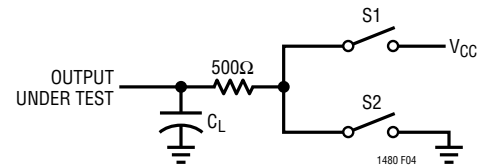

Figure 4. Driver Timing Test Load

## SWITCHING TIME WAVEFORMS

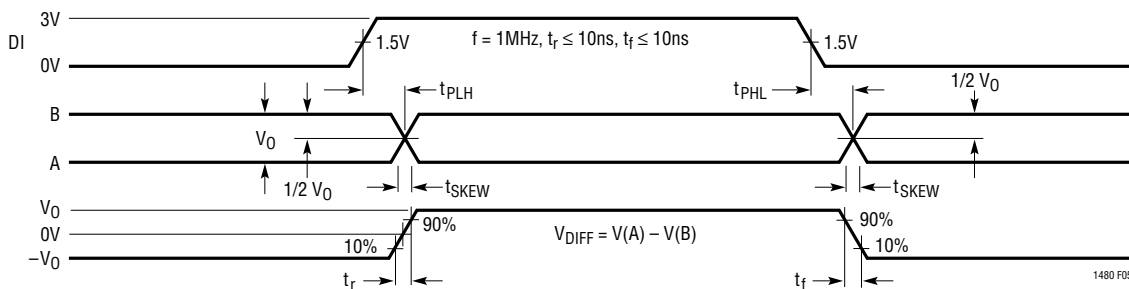

Figure 5. Driver Propagation Delays

# SWITCHING TIME WAVEFORMS

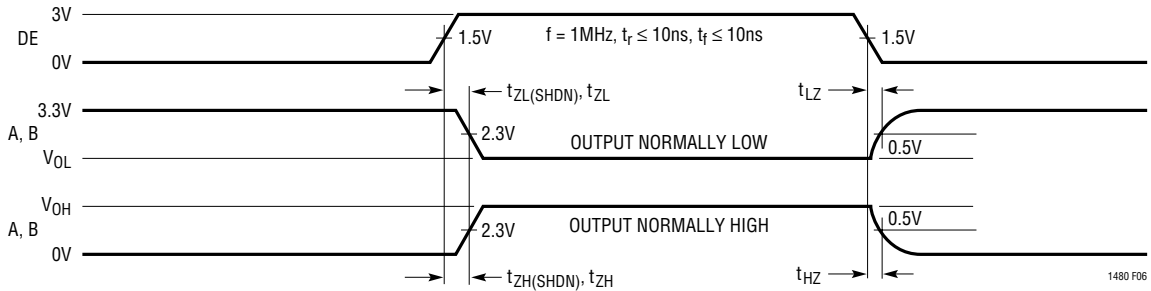

Figure 6. Driver Enable and Disable Times

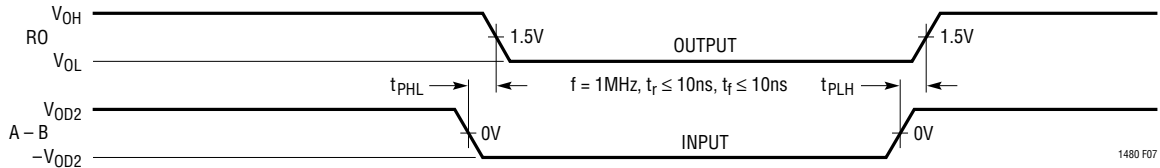

Figure 7. Receiver Propagation Delays

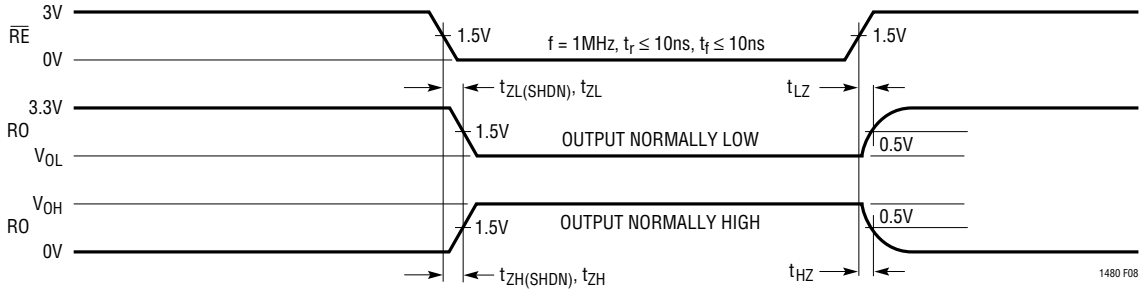

Figure 8. Receiver Enable and Disable Times

## APPLICATIONS INFORMATION

### CMOS Output Driver

The LTC1480 transceiver provides full RS485 compatibility while operating from a single 3.3V supply. The RS485 specification requires that a transceiver withstand common mode voltages of up to 12V or -7V at the RS485 line connections. Additionally, the transceiver must be immune to both ESD and latch-up. This rules out traditional CMOS drivers, which include parasitic diodes from their driver outputs to each supply rail (Figure 9). The LTC1480 uses a proprietary process enhancement which adds a pair of Schottky diodes to the output stage (Figure 10), preventing

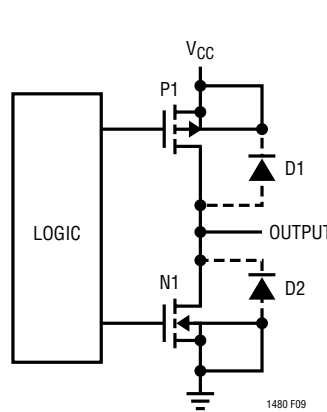

Figure 9. Conventional CMOS Output Stage

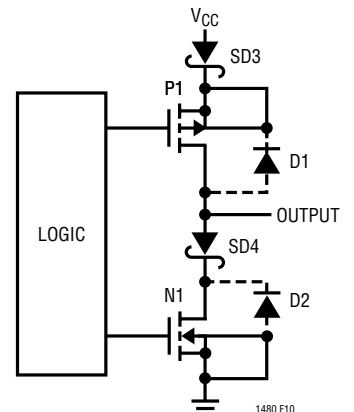

Figure 10. LTC1480 Output Stage

1480fa

## APPLICATIONS INFORMATION

current from flowing when the common mode voltage exceeds the supply rails. Latch-up at the output drivers is virtually eliminated and the driver is prevented from loading the line under RS485 specified fault conditions.

When two or more drivers are connected to the same transmission line, a potential condition exists whereby more than two drivers are simultaneously active. If one or more drivers is sourcing current while another driver is sinking current, excessive power dissipation may occur within either the sourcing or sinking element. This condition is defined as driver contention, since multiple drivers are competing for one transmission line. The LTC1480 provides a current limiting scheme to prevent driver contention failure. When driver contention occurs, the current drawn is limited to about 70mA preventing excessive power dissipation within the drivers.

The LTC1480 has a thermal shutdown feature which protects the part from excessive power dissipation. Under extreme fault conditions, up to 250mA can flow through the part causing rapid internal temperature rise. The thermal shutdown circuit will disable the driver outputs when the internal temperature reaches 150°C and turns them back on when the temperature cools to 130°C. This cycle will repeat as necessary until the fault condition is removed.

### Receiver Inputs

The LTC1480 features an input common mode range covering the entire RS485 specified range of -7V to 12V. Differential signals of greater than  $\pm 200\text{mV}$  within the specified input common mode range will be converted to a TTL compatible signal at the receiver output. A small amount of input hysteresis is included to minimize the effects of noise on the line signals. If the receiver inputs are floating (unterminated) an internal pull-up of 10 $\mu\text{A}$  at the A input will force the receiver output to a known high state.

### Low Power Operation

The LTC1480 draws very little supply current whenever the driver outputs are disabled. In shutdown mode the quiescent current is typically less than 1 $\mu\text{A}$ . With the receiver active and the driver outputs disabled, the LTC1480 will typically draw 300 $\mu\text{A}$  quiescent current. With the

driver outputs enabled but unterminated, quiescent current will rise as one of the two outputs sources current into the internal receiver input resistance. With the minimum receiver input resistance of 12k and the maximum output swing of 3.3V, the quiescent current will rise by a maximum of 275 $\mu\text{A}$ . Typical quiescent current rise with the driver enabled is about 100 $\mu\text{A}$ .

The quiescent current rises significantly if the driver is enabled when it is externally terminated. With 1/2 termination load (120 $\Omega$  between the driver outputs) the quiescent current will jump to at least 13mA as the drivers force a minimum of 1.5V across the termination resistance. With a fully terminated 60 $\Omega$  line attached, the current will rise to greater than 25mA with the driver enabled, completely overshadowing the extra 100 $\mu\text{A}$  drawn by internal receiver inputs.

### Shutdown Mode

Both the receiver output (RO) and the driver outputs (A, B) can be placed in three-state mode by bringing  $\overline{\text{RE}}$  HIGH and DE LOW respectively. In addition, the LTC1480 will enter shutdown mode when  $\overline{\text{RE}}$  is HIGH and DE is LOW.

In shutdown the LTC1480 typically draws only 1 $\mu\text{A}$  of supply current. In order to guarantee that the part goes into shutdown,  $\overline{\text{RE}}$  must be high and DE must be LOW for at least 600ns simultaneously. If this time duration is less than 50ns the part will not enter shutdown mode.

### Propagation Delay

Many digital encoding schemes are dependent upon the difference in the propagation delay times of the driver and receiver. Figure 11 shows the test circuit for the LTC1480 propagation delay.

The receiver delay times are:

$$|t_{\text{PLH}} - t_{\text{PHL}}| = 13\text{ns Typ, } V_{\text{CC}} = 3.3\text{V}$$

The driver's skew times are:

$$t_{\text{SKEW}} = 10\text{ns Typ, } V_{\text{CC}} = 3.3\text{V} \\ 20\text{ns Max, } V_{\text{CC}} = 3.3\text{V, } T_{\text{A}} = -40^{\circ}\text{C to } 85^{\circ}\text{C}$$



## APPLICATIONS INFORMATION

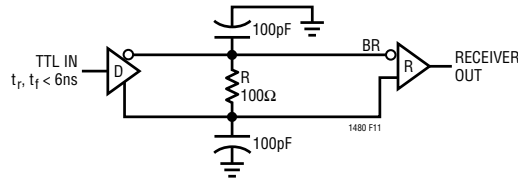
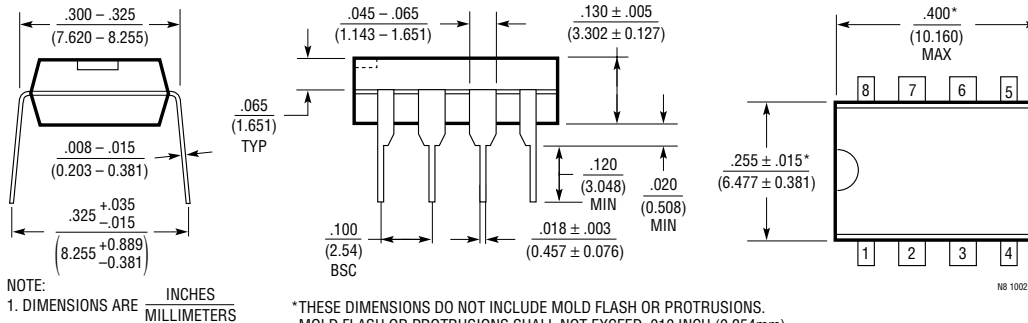

Figure 11. Receiver Propagation Delay Test Circuit

## PACKAGE DESCRIPTION

### N8 Package 8-Lead PDIP (Narrow .300 Inch) (Reference LTC DWG # 05-08-1510)



### S8 Package 8-Lead Plastic Small Outline (Narrow .150 Inch) (Reference LTC DWG # 05-08-1610)

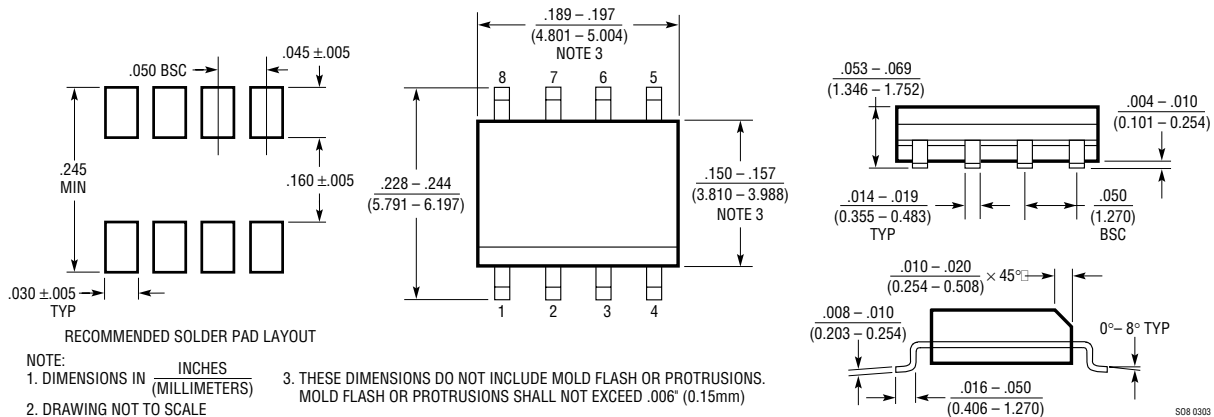

## RELATED PARTS

PART NUMBER	DESCRIPTION	COMMENTS
LTC485	5V Low Power RS485 Interface Transceiver	Low Power
LTC1481	5V Ultralow Power RS485 Transceiver with Shutdown	Lowest Power
LTC1483	5V Ultralow Power RS485 Low EMI Transceiver with Shutdown	Low EMI/Lowest Power
LTC1485	5V Differential Bus Transceiver	High Speed, 10Mbps
LTC1487	5V Ultralow Power RS485 with Low EMI, Shutdown and High Input Impedance	High Input Impedance/Low EMI/Lowest Power