



Chipsmall Limited consists of a professional team with an average of over 10 year of expertise in the distribution of electronic components. Based in Hongkong, we have already established firm and mutual-benefit business relationships with customers from,Europe,America and south Asia,supplying obsolete and hard-to-find components to meet their specific needs.

With the principle of “Quality Parts,Customers Priority,Honest Operation,and Considerate Service”,our business mainly focus on the distribution of electronic components. Line cards we deal with include Microchip,ALPS,ROHM,Xilinx,Pulse,ON,Everlight and Freescale. Main products comprise IC,Modules,Potentiometer,IC Socket,Relay,Connector.Our parts cover such applications as commercial,industrial, and automotives areas.

We are looking forward to setting up business relationship with you and hope to provide you with the best service and solution. Let us make a better world for our industry!



Contact us

Tel: +86-755-8981 8866 Fax: +86-755-8427 6832

Email & Skype: info@chipsmall.com Web: www.chipsmall.com

Address: A1208, Overseas Decoration Building, #122 Zhenhua RD., Futian, Shenzhen, China



FEATURES

- Regulates V_{OUT} Above, Below or Equal to V_{IN}
- Wide V_{IN} Range: 2.4V to 25V, <1V to 25V (Using $EXTV_{CC}$ Input)
- V_{OUT} Range: 1V to 25V
- Adjustable Output Voltage (LTC[®]3130)
- Four Selectable Fixed Output Voltages (LTC3130-1)
- 1.2 μ A No-Load Input Current in Burst Mode[®] Operation ($V_{IN} = 12V$, $V_{OUT} = 5V$)
- 600mA Output Current in Buck Mode
- Pin-Selectable 850mA/450mA Current Limit (LTC3130)
- Up to 95% Efficiency
- Pin-Selectable Burst Mode Operation
- 1.2MHz Ultralow Noise PWM Frequency
- Accurate RUN Pin Threshold
- Power Good Indicator
- Programmable Maximum Power Point Control
- $I_Q = 500nA$ in Shutdown
- Thermally-Enhanced 20-Lead 3mm \times 4mm QFN and 16-Lead MSOP Packages

APPLICATIONS

- Long-Life, Battery-Operated Instruments
- Portable Military Radios
- Low Power Sensors
- Solar Panel Post-Regulator/Charger

DESCRIPTION

The LTC3130/LTC3130-1 are high efficiency, low noise, 600mA buck-boost converters with wide V_{IN} and V_{OUT} ranges. For high efficiency operation at light loads, Burst Mode operation can be selected, reducing the quiescent current to just 1.6 μ A. Converter start-up is achieved from sources as low as 7.5 μ W.

The LTC3130/LTC3130-1 employ an ultralow noise, 1.2MHz PWM architecture that minimizes solution footprint by allowing the use of tiny, low profile inductors and ceramic capacitors. Built-in loop compensation and soft-start reduces external parts count and simplifies the design. Features include an accurate RUN comparator threshold to allow predictable regulator turn-on and a maximum power point control (MPPC) capability that ensures maximum power extraction from non-ideal sources such as photovoltaic panels. The LTC3130-1 includes an internal voltage divider to provide four selectable fixed output voltages.

Additional features include a power good output, an external V_{CC} input and thermal shutdown.

The LTC3130 and LTC3130-1 are available in thermally-enhanced 20-lead 3mm \times 4mm QFN and 16-lead MSOP packages.

LT, LTC, LTM, Linear Technology, the Linear logo and Burst Mode are registered trademarks and PowerPath is a trademark of Linear Technology Corporation. All other trademarks are the property of their respective owners.

TYPICAL APPLICATION

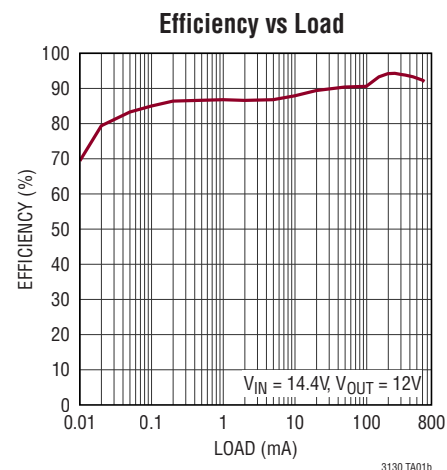
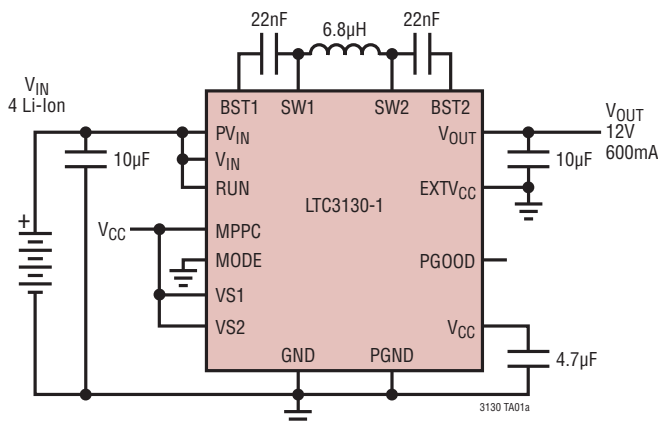

LTC3130/LTC3130-1

ABSOLUTE MAXIMUM RATINGS (Notes 1, 8)

PV_{IN} , V_{IN} , V_{OUT} Voltage	-0.3 to 27.5V
$EXTV_{CC}$ Voltage	-0.3 to 27.5V
BST1, BST2 Voltage	(SW - 0.3V) to (SW + 6V)
RUN, PGOOD Voltage.....	-0.3 to 27.5V
MODE, MPPC	-0.3 to 6V
VS1, VS2 Voltage (LTC3130-1)	-0.3 to 6V
ILIM, FB Voltage (LTC3130)	-0.3 to 6V
PGOOD Sink Current.....	12mA

Operating Junction Temperature	
Range (Notes 2, 5, 6).....	-40°C to 125°C
Storage Temperature Range	-65°C to 150°C
Lead Temperature (Soldering, 10sec)	
MSE	300°C

PIN CONFIGURATION

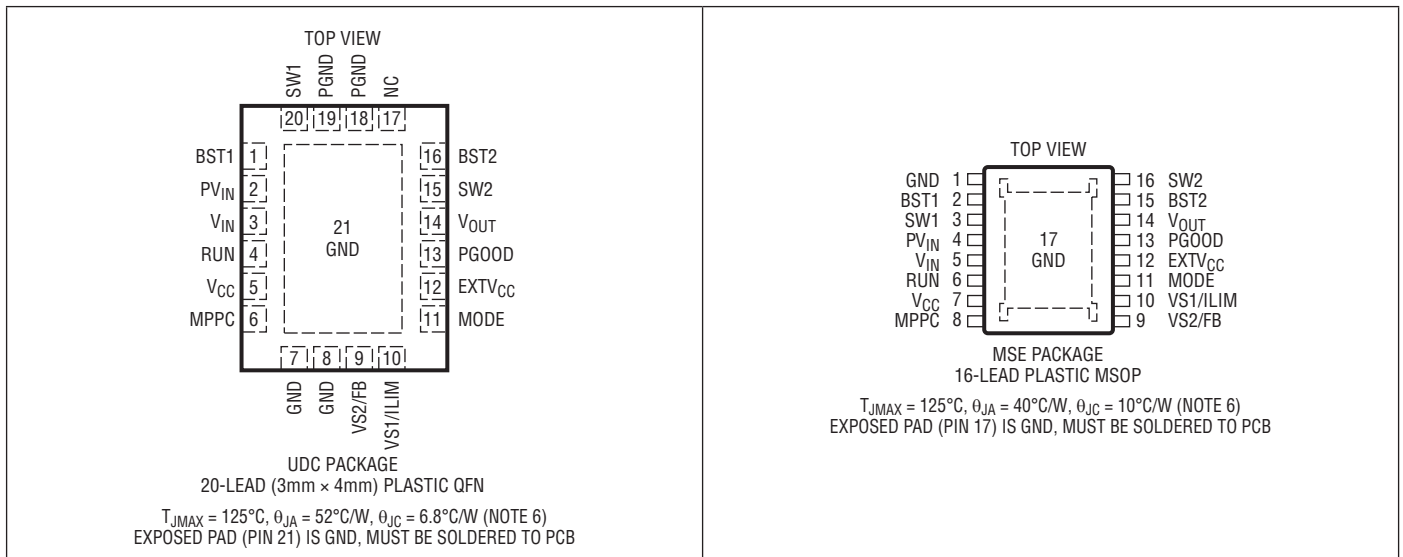

ORDER INFORMATION <http://www.linear.com/product/LTC3130#orderinfo>

LEAD FREE FINISH	TAPE AND REEL	PART MARKING*	PACKAGE DESCRIPTION	TEMPERATURE RANGE
LTC3130EUDC#PBF	LTC3130EUDC#TRPBF	LGTS	20-Lead (3mm × 4mm) Plastic QFN	-40°C to 125°C
LTC3130EUDC-1#PBF	LTC3130EUDC-1#TRPBF	LGTT	20-Lead (3mm × 4mm) Plastic QFN	-40°C to 125°C
LTC3130IUUDC#PBF	LTC3130IUUDC#TRPBF	LGTS	20-Lead (3mm × 4mm) Plastic QFN	-40°C to 125°C
LTC3130IUUDC-1#PBF	LTC3130IUUDC-1#TRPBF	LGTT	20-Lead (3mm × 4mm) Plastic QFN	-40°C to 125°C
LTC3130EMSE#PBF	LTC3130EMSE#TRPBF	3130	16-Lead Plastic MSOP	-40°C to 125°C
LTC3130EMSE-1#PBF	LTC3130EMSE-1#TRPBF	31301	16-Lead Plastic MSOP	-40°C to 125°C
LTC3130IMSE#PBF	LTC3130IMSE#TRPBF	3130	16-Lead Plastic MSOP	-40°C to 125°C
LTC3130IMSE-1#PBF	LTC3130IMSE-1#TRPBF	31301	16-Lead Plastic MSOP	-40°C to 125°C

Consult LTC Marketing for parts specified with wider operating temperature ranges. *The temperature grade is identified by a label on the shipping container. For more information on lead free part marking, go to: <http://www.linear.com/leadfree/>
 For more information on tape and reel specifications, go to: <http://www.linear.com/tapeandree/>. Some packages are available in 500 unit reels through designated sales channels with #TRMPBF suffix.

ELECTRICAL CHARACTERISTICS

The ● denotes the specifications which apply over the specified operating junction temperature range, otherwise specifications are at $T_A = 25^\circ\text{C}$ (Note 2). $PV_{IN} = V_{IN} = 12\text{V}$, $V_{OUT} = 5\text{V}$ unless otherwise noted.

PARAMETER	CONDITIONS		MIN	TYP	MAX	UNITS
V_{IN} Start-Up Voltage	EXTV _{CC} = 0V	●		2.30	2.40	V
	EXTV _{CC} > 3.15V, RUN > 1.1V	●		0.6	1.0	V
Input Voltage Range	EXTV _{CC} > 3.15V, RUN > 1.1V	●	0.6		25	V
Output Voltage Adjust Range (LTC3130)		●	1.0		25	V
Feedback Voltage (LTC3130)	For External FB Resistor Applications	●	0.975	1.000	1.020	V
	From -40°C to $+85^\circ\text{C}$ (Note 3)		0.980	1.000	1.020	V
Feedback Input Current (LTC3130)	FB = 1.1V			0.1	10	nA
Fixed V_{OUT} Voltages (LTC3130-1)	VS1 = VS2 = 0V	●	1.75	1.80	1.85	V
	VS1 = V _{CC} , VS2 = 0V	●	3.20	3.3	3.39	V
	VS1 = 0V, VS2 = V _{CC}	●	4.85	5.0	5.125	V
	VS1 = VS2 = V _{CC}	●	11.64	12.0	12.30	V
V_{IN} Quiescent Current – Shutdown	RUN < 0.2V			500	850	nA
V_{IN} Quiescent Current – UVLO	0.85V < RUN < 0.9V, EXTV _{CC} = 0V			1.4	2.4	μA
V_{IN} Quiescent Current – Burst Mode Operation (Sleeping)	FB > 1.02V (LTC3130), $V_{OUT} > V_{REG}$ (LTC3130-1), MODE = 0V, RUN = V_{IN} , MPPC > 1.05V			1.6	2.7	μA
NMOS Switch Leakage on V_{IN} and V_{OUT}	SW1 = SW2 = 0V, $V_{IN} = V_{OUT} = 25\text{V}$			5	100	nA
NMOS Switch On-Resistance	V _{CC} = 4V			0.35		Ω
Inductor Average Current Limit	LTC3130-1 (Note 4), LTC3130: ILIM = V _{CC} (Note 4)	●	660	850	1200	mA
	LTC3130: ILIM = 0V (Note 4)	●	250	450	650	mA
Inductor Peak Current Limit	LTC3130-1 (Note 4), LTC3130: ILIM = V _{CC} (Note 4)	●	0.9	1.3	1.7	A
	LTC3130: ILIM = 0V (Note 4)	●	0.6	0.85	1.15	A
Maximum Boost Duty Cycle (Percentage of Period SW2 is Low)	LTC3130-1: $V_{OUT} < V_{REG}$ (Note 7), LTC3130: FB < 0.975V (Note 7)	●	91	94	97	%
	LTC3130-1: $V_{OUT} > V_{REG}$ (Note 7), LTC3130: FB > 1.02V (Note 7)	●			0	%
Switching Frequency		●	1.00	1.20	1.40	MHz
SW1 and SW2 Minimum Low Time	(Note 3)			70		ns
MPPC Reference Voltage		●	0.95	1.00	1.05	V
MPPC Input Current	MPPC = 5V			1	20	nA
RUN Logic Threshold to Enable Reference		●	0.2	0.6	0.85	V
RUN Threshold to Enable Switching (Rising)	$V_{IN} > 2.4\text{V}$ or EXTV _{CC} > 3.15V	●	1.01	1.05	1.09	V
RUN Threshold Hysteresis		●	90	100	110	mV
RUN Input Current	RUN = 25V			1	30	nA
	RUN = 1V			0.1	5	nA
ILIM Input Logic High	(LTC3130)	●	1.1			V
ILIM Input Logic Low	(LTC3130)	●			0.35	V
ILIM Input Current	(LTC3130) ILIM = 5V			1	20	nA
VS1, VS2 Input Logic High	(LTC3130-1)	●	1.1			V
VS1, VS2 Input Logic Low	(LTC3130-1)	●			0.35	V
VS1, VS2 Input Current	(LTC3130-1) VS1, VS2 = 5V			1	20	nA
MODE Input Logic High		●	1.1			V
MODE Input Logic Low		●			0.35	V
MODE Input Current	MODE = 5V (If RUN is Low or V _{CC} is in UVLO)			1	20	nA
	MODE = 5V (If Switching is Enabled)			1.7	4	μA

LTC3130/LTC3130-1

ELECTRICAL CHARACTERISTICS

The ● denotes the specifications which apply over the specified operating junction temperature range, otherwise specifications are at $T_A = 25^\circ\text{C}$ (Note 2). $PV_{IN} = V_{IN} = 12\text{V}$, $V_{OUT} = 5\text{V}$ unless otherwise noted.

PARAMETER	CONDITIONS	MIN	TYP	MAX	UNITS
Soft-Start Time	For Average Inductor Current to Reach Limit		12		ms
V_{CC} Voltage	$(EXTV_{CC} \text{ or } V_{IN}) > 4.7\text{V}$, $RUN > 0.85\text{V}$		4		V
V_{CC} Voltage — Shutdown	$RUN \leq 0.2\text{V}$		3.25		V
V_{CC} Dropout Voltage ($V_{IN} - V_{CC}$)	$V_{IN} = 3.0\text{V}$, Switching		50	100	mV
V_{CC} Current Limit	$V_{CC} = 0\text{V}$		17	34	mA
V_{CC} UVLO Threshold (Rising)		● 2.20	2.3	2.40	V
V_{CC} UVLO Hysteresis		100	120	135	mV
$EXTV_{CC}$ Enable Threshold		● 2.85	3.0	3.15	V
$EXTV_{CC}$ Enable Hysteresis			260		mV
$EXTV_{CC}$ Input Operating Range		● 3.15		25	V
$EXTV_{CC}$ Quiescent Current – Burst Mode Operation (Sleeping)	$EXTV_{CC} > 3.15\text{V}$, $FB > 1.02\text{V}$ (LTC3130), $MPPC > 1.05\text{V}$ $V_{OUT} > V_{REG}$ (LTC3130-1), $MODE = 0\text{V}$, $RUN > 1.10\text{V}$		1.6	2.5	μA
$EXTV_{CC}$ Quiescent Current – Shutdown	$EXTV_{CC} = 5\text{V}$, $RUN < 0.2\text{V}$		400	750	nA
$EXTV_{CC}$ Current Limit	$V_{CC} = 0\text{V}$, $EXTV_{CC} = 15\text{V}$		32	68	mA
V_{IN} Sleep Current When Powered by $EXTV_{CC}$	$FB > 1.02\text{V}$ (LTC3130), $V_{OUT} > V_{REG}$ (LTC3130-1), $EXTV_{CC} > 3.15\text{V}$, $MODE = 0\text{V}$, $RUN > 1.10\text{V}$, $V_{IN} = 12\text{V}$, $MPPC > 1.05\text{V}$		600		nA
V_{OUT} UV Threshold	Rising	● 0.35	0.7	0.95	V
V_{OUT} UV Hysteresis			55		mV
V_{OUT} Quiescent Current – Shutdown			$\frac{(V_{OUT-1})}{27}$	$\frac{(V_{OUT})}{17}$	μA
V_{OUT} Quiescent Current – Burst Mode Operation (Sleeping)	$MODE = 0\text{V}$, $FB > 1.02\text{V}$, $MPPC > 1.05\text{V}$		$\frac{(V_{OUT-1})}{27}$	$\frac{(V_{OUT})}{17}$	μA
PGOOD Threshold, Rising	Referenced to Programmed V_{OUT} Voltage	-7.0	-5.0	-3.0	%
PGOOD Hysteresis	Referenced to Programmed V_{OUT} Voltage		2.5		%
PGOOD Voltage Low	$I_{SINK} = 1\text{mA}$		165	250	mV
PGOOD Leakage	PGOOD = 25V		1	50	nA

Note 1: Stresses beyond those listed under Absolute Maximum Ratings may cause permanent damage to the device. Exposure to any Absolute Maximum Rating condition for extended periods may affect device reliability and lifetime.

Note 2: The LTC3130/LTC3130-1 is tested under pulsed load conditions such that $T_J \approx T_A$. The LTC3130E/LTC3130E-1 is guaranteed to meet specifications from 0°C to 85°C junction temperature. Specifications over the -40°C to 125°C operating junction temperature range are assured by design, characterization and correlation with statistical process controls. The LTC3130I/LTC3130I-1 is guaranteed over the -40°C to 125°C operating junction temperature range. The junction temperature (T_J) is calculated from the ambient temperature (T_A) and power dissipation (P_D) according to the formula:

$$T_J = T_A + (P_D \cdot \theta_{JA}^\circ\text{C/W}),$$

where θ_{JA} is the package thermal impedance. Note that the maximum ambient temperature consistent with these specifications is determined by specific operating conditions in conjunction with board layout, the rated thermal package thermal resistance and other environmental factors.

Note 3: Specification is guaranteed by design and not 100% tested in production.

Note 4: Current measurements are made when the output is not switching.

Note 5: This IC includes overtemperature protection that is intended to protect the device during momentary overload conditions. Junction temperature will exceed 165°C when overtemperature protection is active. Continuous operation above the specified maximum operating junction temperature may result in device degradation or failure.

Note 6: Failure to solder the exposed backside of the package to the PC board ground plane will result in a much higher thermal resistance.

Note 7: Switching time measurements are made in an open-loop test configuration. Timing in the application may vary somewhat from these values due to differences in the switch pin voltage during non-overlap durations when switch pin voltage is influenced by the magnitude and duration of the inductor current.

Note 8: Voltage transients on the switch pin(s) beyond the DC limits specified in the Absolute Maximum Ratings are non-disruptive to normal operation when using good layout practices as described elsewhere in the data sheet and application notes and as seen on the product demo board.

TYPICAL PERFORMANCE CHARACTERISTICS $T_A = 25^\circ\text{C}$, unless otherwise noted.

Efficiency, $V_{OUT} = 1.8\text{V}$, PWM Mode

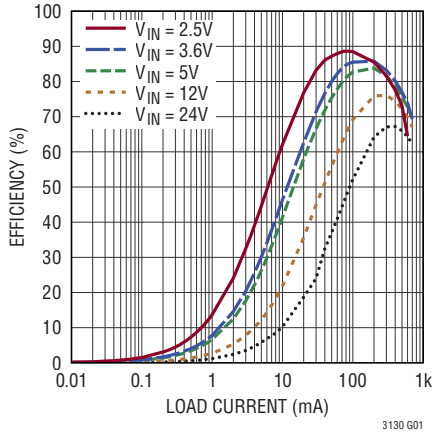

Efficiency, $V_{OUT} = 3.3\text{V}$, PWM Mode

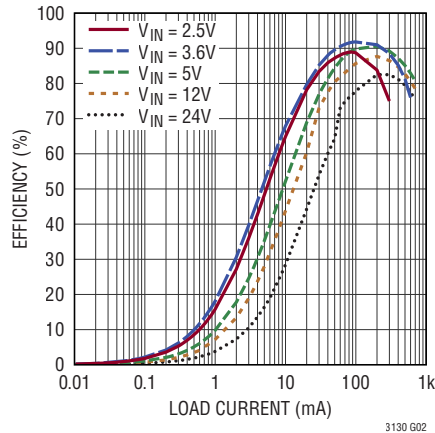

Efficiency, $V_{OUT} = 5\text{V}$, PWM Mode

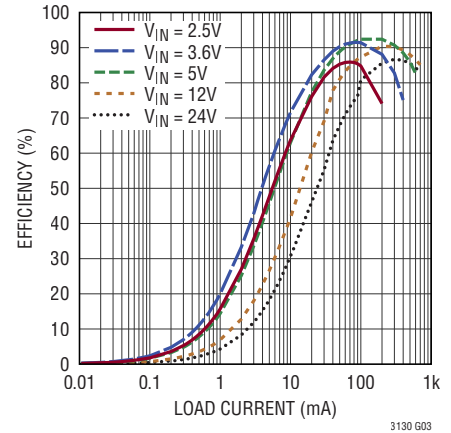

Efficiency, $V_{OUT} = 12\text{V}$, PWM Mode

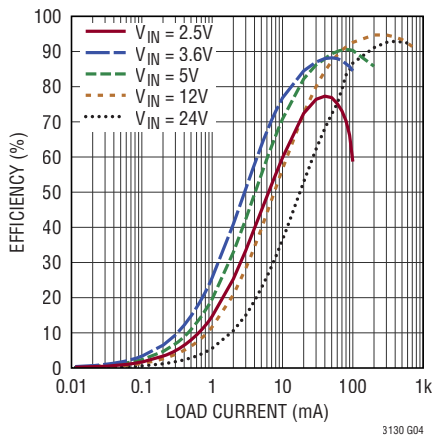

Efficiency, $V_{OUT} = 1.8\text{V}$, Burst Mode Operation (LTC3130-1)

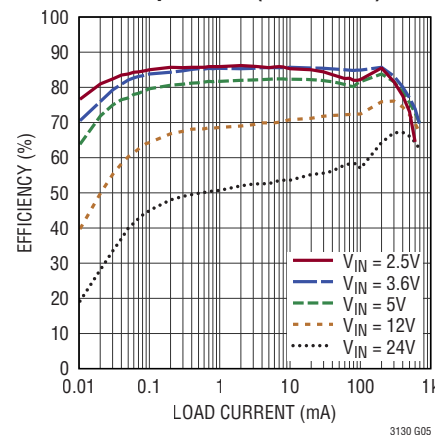

Power Loss, $V_{OUT} = 1.8\text{V}$, Burst Mode Operation (LTC3130-1)

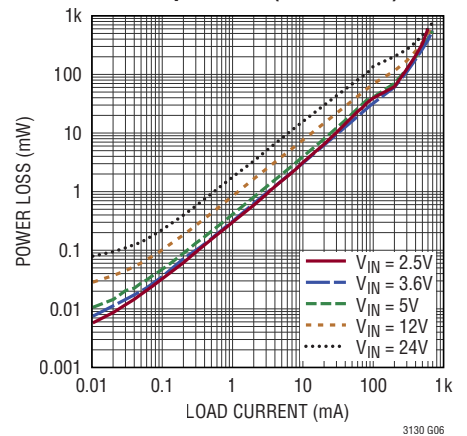

Efficiency, $V_{OUT} = 3.3\text{V}$, Burst Mode Operation (LTC3130-1)

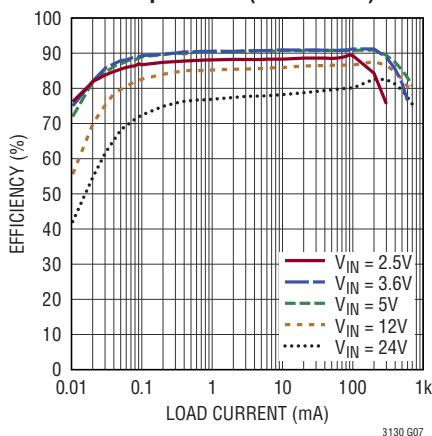

Power Loss, $V_{OUT} = 3.3\text{V}$, Burst Mode Operation (LTC3130-1)

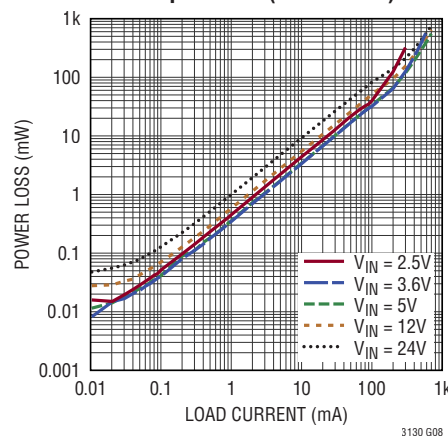

Efficiency, $V_{OUT} = 5\text{V}$, Burst Mode Operation (LTC3130-1)

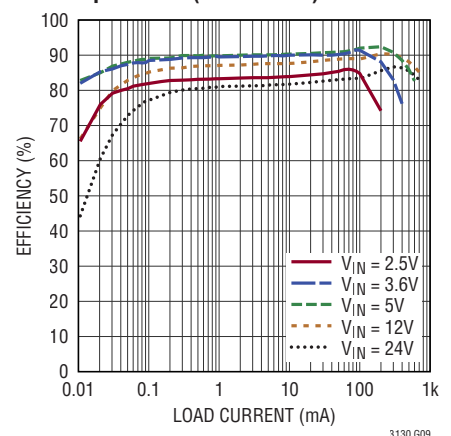

LTC3130/LTC3130-1

TYPICAL PERFORMANCE CHARACTERISTICS $T_A = 25^\circ\text{C}$, unless otherwise noted.

Power Loss, $V_{OUT} = 5\text{V}$, Burst Mode Operation (LTC3130-1)

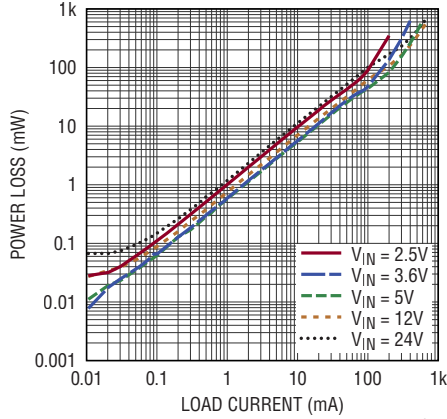

3130 G10

Efficiency, $V_{OUT} = 12\text{V}$, Burst Mode Operation (LTC3130-1)

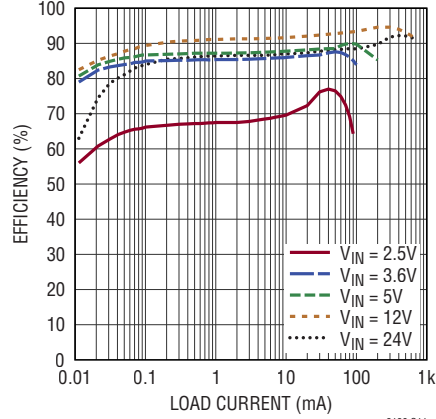

3130 G11

Power Loss, $V_{OUT} = 12\text{V}$, Burst Mode Operation (LTC3130-1)

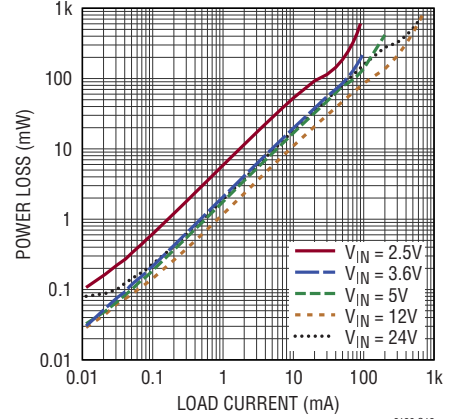

3130 G12

Efficiency, $V_{OUT} = 8\text{V}$, PWM Mode (LTC3130)

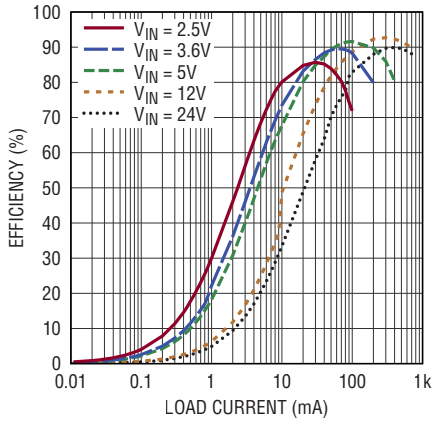

3130 G13

Efficiency, $V_{OUT} = 8\text{V}$, Burst Mode Operation (LTC3130)

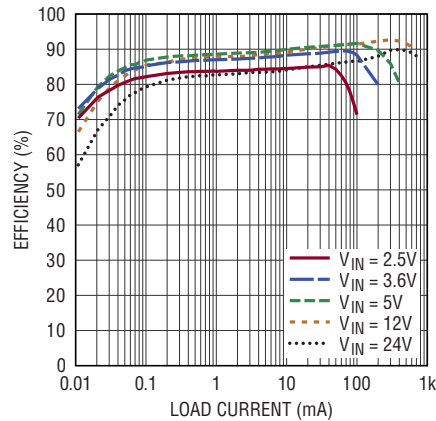

3130 G14

Power Loss, $V_{OUT} = 8\text{V}$, Burst Mode Operation (LTC3130)

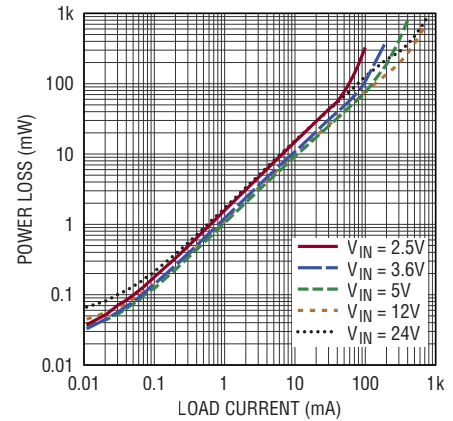

3130 G15

Efficiency, $V_{OUT} = 15\text{V}$ (LTC3130)

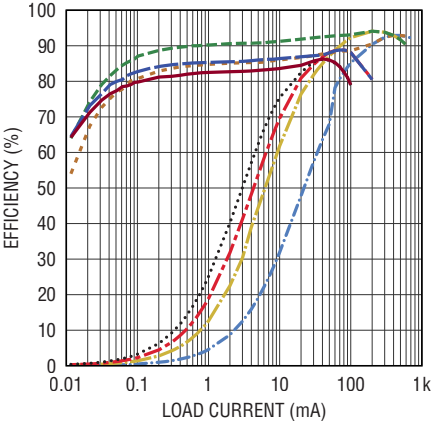

3130 G16

Power Loss, $V_{OUT} = 15\text{V}$, Burst Mode Operation (LTC3130)

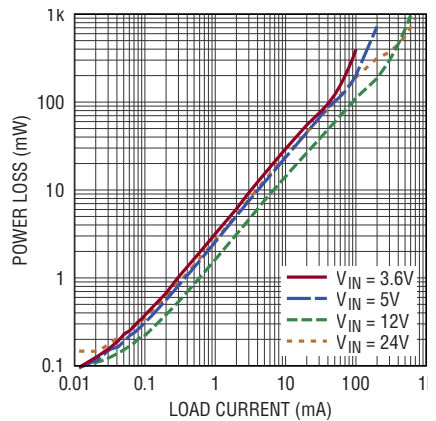

3130 G17

Efficiency, $V_{OUT} = 24\text{V}$ (LTC3130)

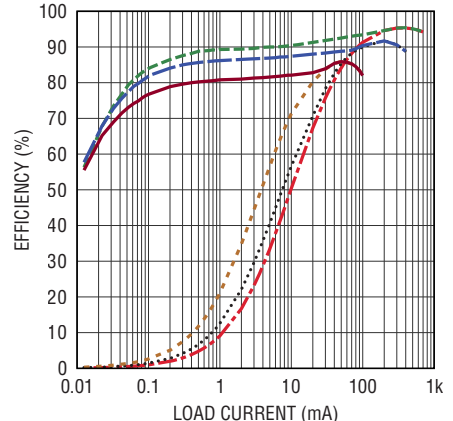

3130 G18

Burst Mode OPERATION:
 — $V_{IN} = 3.6\text{V}$
 — $V_{IN} = 5\text{V}$
 — $V_{IN} = 12\text{V}$
 — $V_{IN} = 24\text{V}$

PWM:
 $V_{IN} = 5\text{V}$
 $V_{IN} = 12\text{V}$
 $V_{IN} = 24\text{V}$

Burst Mode OPERATION:
 — $V_{IN} = 5\text{V}$
 — $V_{IN} = 12\text{V}$
 — $V_{IN} = 24\text{V}$

PWM:
 $V_{IN} = 5\text{V}$
 $V_{IN} = 12\text{V}$
 $V_{IN} = 24\text{V}$

3130f

TYPICAL PERFORMANCE CHARACTERISTICS $T_A = 25^\circ\text{C}$, unless otherwise noted.

Power Loss, $V_{OUT} = 24\text{V}$, Burst Mode Operation (LTC3130)

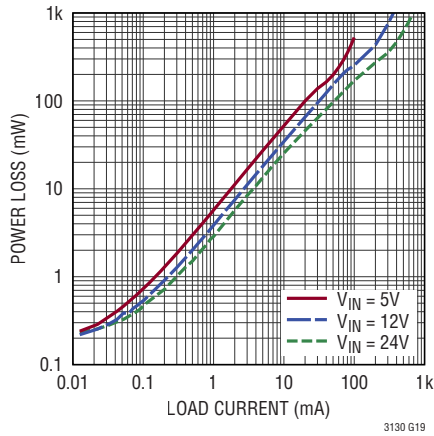

Maximum Output Current vs V_{IN} and V_{OUT}

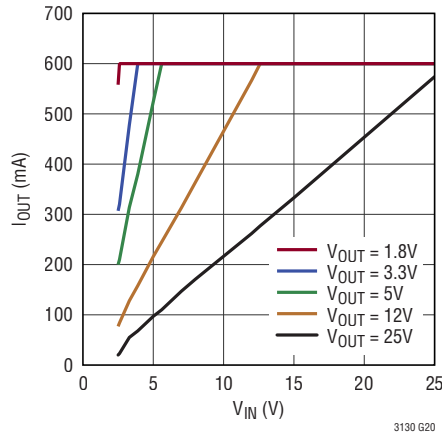

V_{IN} Shutdown Current vs V_{IN} (RUN = 0V, EXT V_{CC} = 0V)

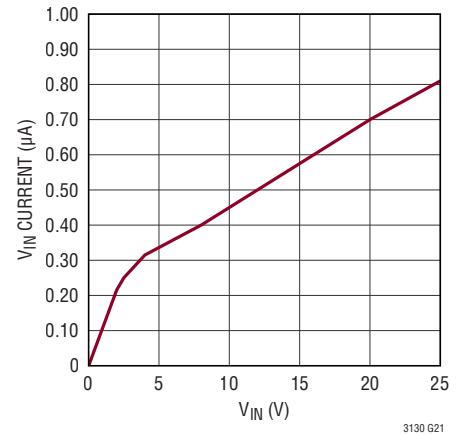

V_{IN} UVLO Current vs V_{IN} ($0.85\text{V} \leq \text{RUN} \leq 1.01\text{V}$, EXT V_{CC} = 0V)

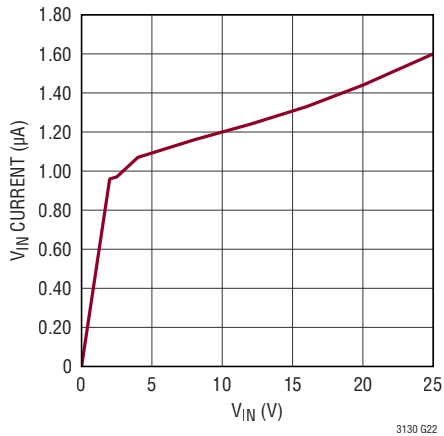

No-Load Input Current in Burst Mode Operation vs V_{IN} and V_{OUT} (LTC3130, MODE = 0V)

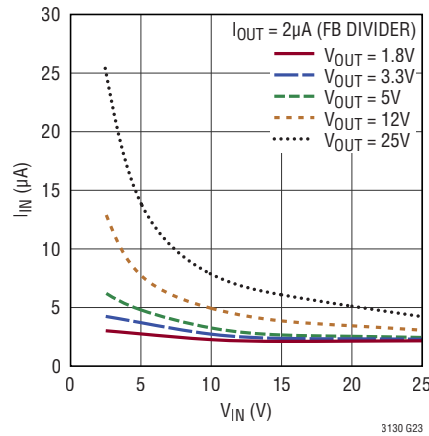

No-Load Input Current in Burst Mode Operation vs V_{IN} and V_{OUT} (LTC3130-1, MODE = 0V)

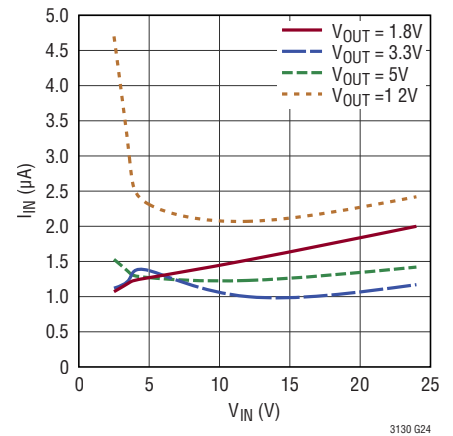

No-Load Input Current in Fixed Frequency vs V_{IN} and V_{OUT} (MODE = V_{CC})

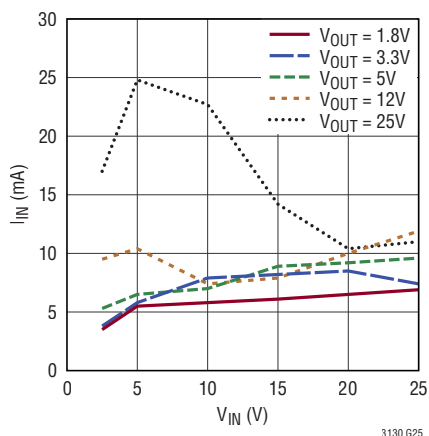

Burst Mode Operation, Load Current Threshold vs V_{IN} and V_{OUT} (MODE = 0V)

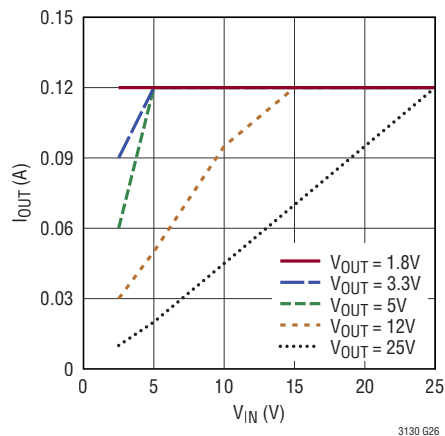

Average Inductor Current Limit vs MPPC Voltage

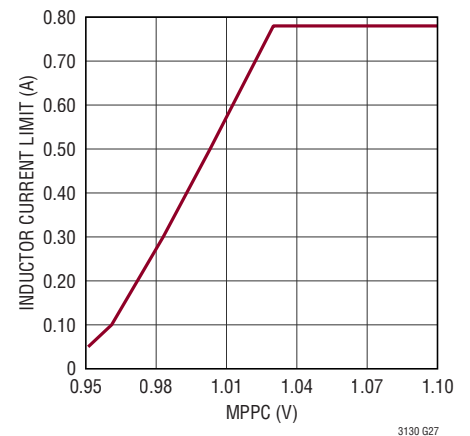

TYPICAL PERFORMANCE CHARACTERISTICS $T_A = 25^\circ\text{C}$, unless otherwise noted.

Average Current Limit vs Temperature (Normalized to 25°C)

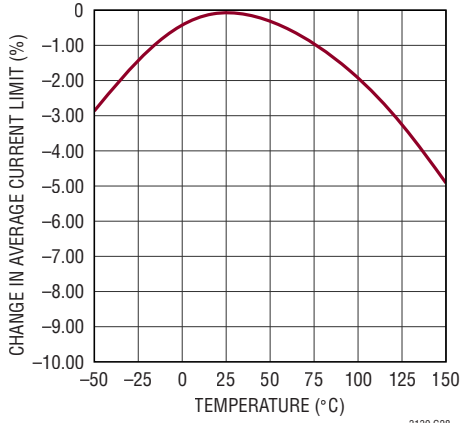

FB Voltage vs Temperature LTC3130 (Normalized to 25°C)

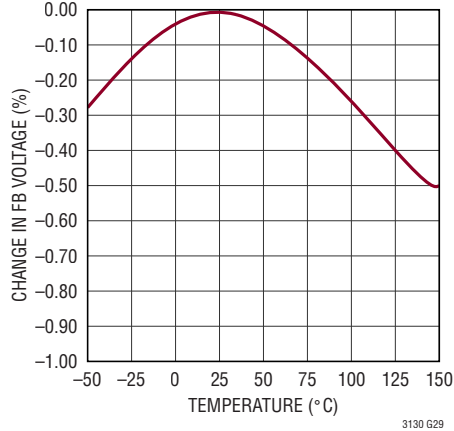

Output Voltage vs Temperature LTC3130-1 (Normalized to 25°C)

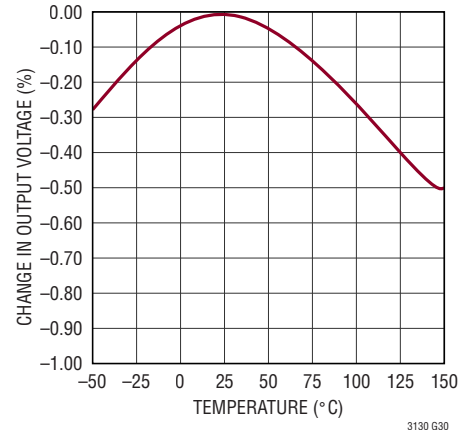

Oscillator Frequency vs Temperature (Normalized to 25°C)

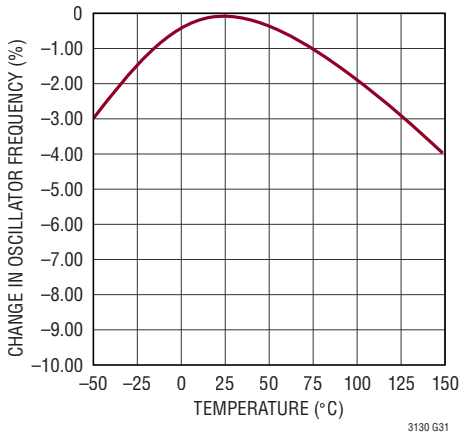

Oscillator Frequency vs V_{CC} (Normalized to $V_{CC} = 4\text{V}$)

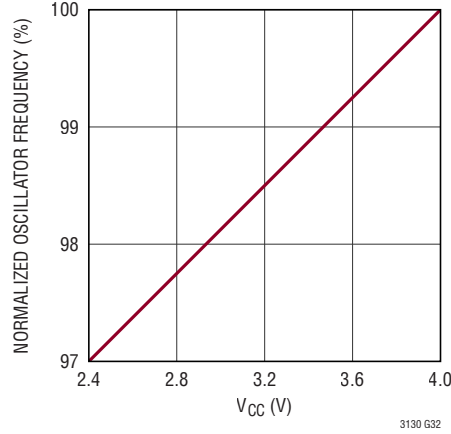

Accurate RUN Threshold vs Temperature (Normalized to 25°C)

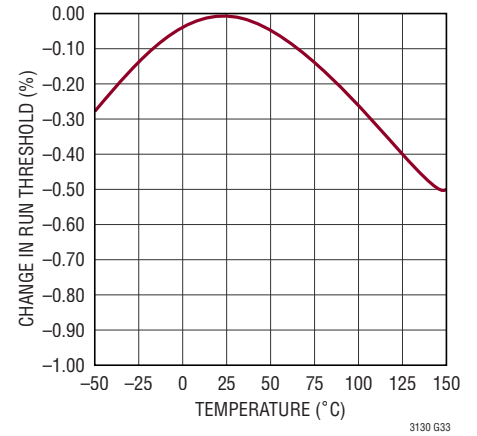

Switch $R_{DS(ON)}$ vs Temperature

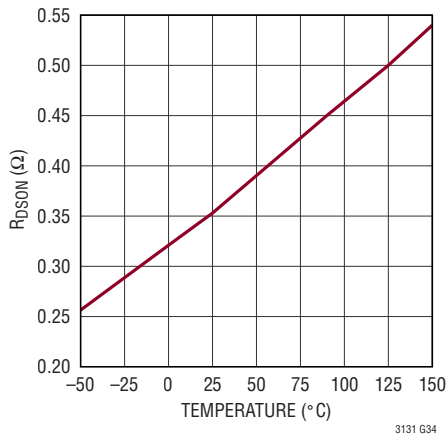

Switch $R_{DS(ON)}$ vs V_{CC}

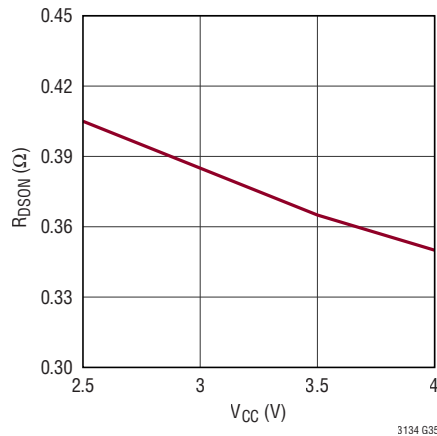

Fixed Frequency PWM Waveforms (Buck Region)

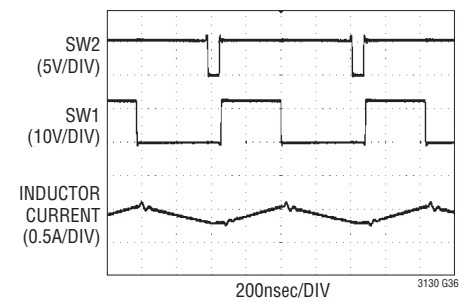

TYPICAL PERFORMANCE CHARACTERISTICS $T_A = 25^\circ\text{C}$, unless otherwise noted.

Fixed Frequency PWM Waveforms (Buck-Boost Region)

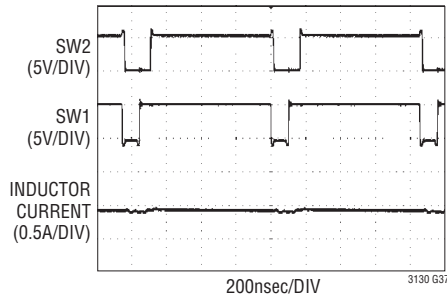

Fixed Frequency PWM Waveforms (Boost Region)

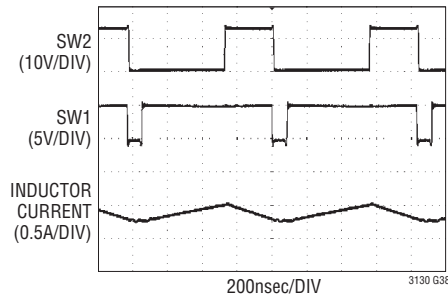

Fixed Frequency Output Voltage Ripple

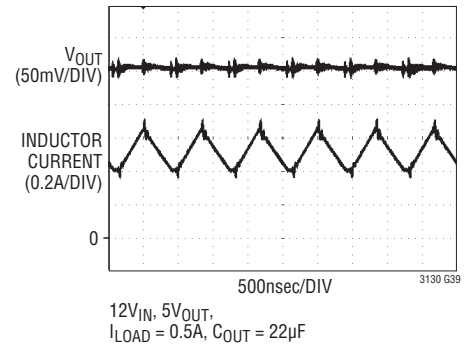

Burst Mode Operation Waveforms

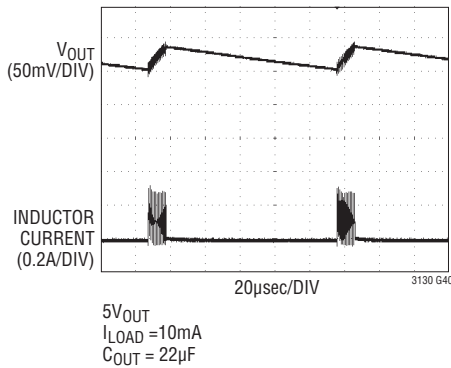

PWM to Burst Mode Operation Transition

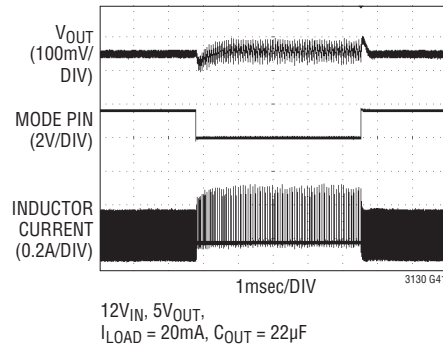

Start-Up Sequence When Applying V_{IN} (RUN Tied to V_{IN})

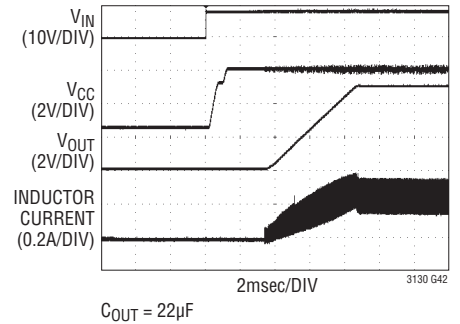

Start-Up Sequence When Raising RUN Pin ($V_{IN} = 12V$)

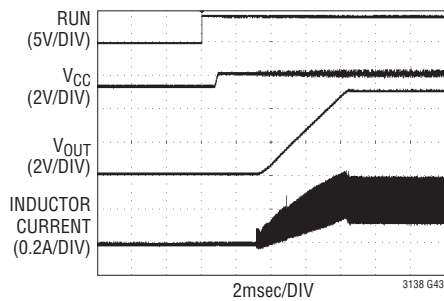

V_{CC} Response to a Step on $EXTV_{CC}$ ($V_{IN} > 4V$)

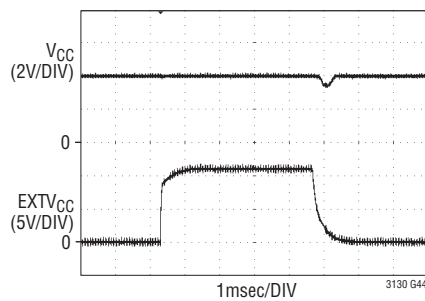

V_{CC} Response to a Step on $EXTV_{CC}$ ($V_{IN} = 3V$)

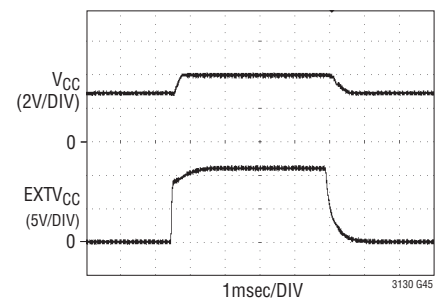

TYPICAL PERFORMANCE CHARACTERISTICS $T_A = 25^\circ\text{C}$, unless otherwise noted.

Step Load Transient Response in Fixed Frequency

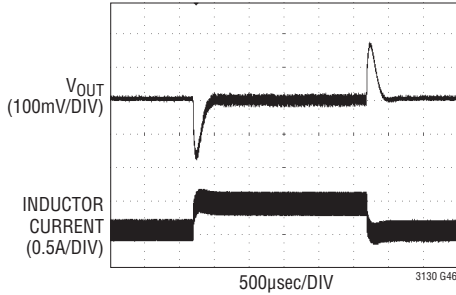

12V_{IN}, 5V_{OUT},
50mA to 500mA LOAD STEP
C_{OUT} = 22µF, L = 10µH

Step Load Transient Response in Burst Mode Operation

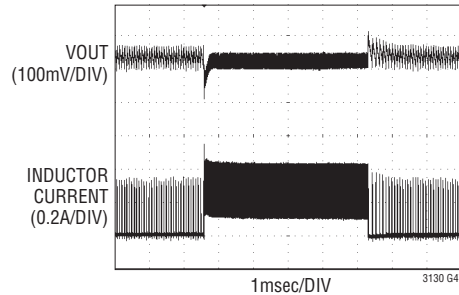

12V_{IN}, 5V_{OUT},
10mA to 250mA LOAD STEP
C_{OUT} = 22µF, L = 10µH

PGOOD Response to a Drop in V_{OUT} Due to a Step Overload

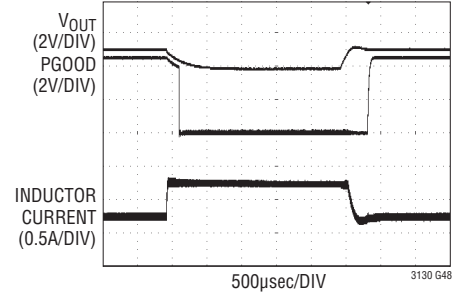

MPPC Response to an Overload (V_{MPPC} Set to 5V at V_{IN})

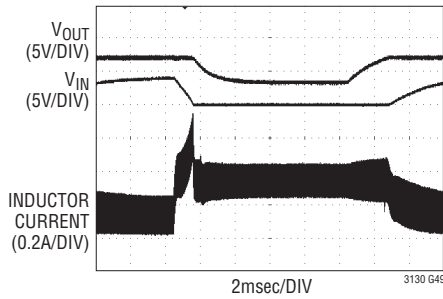

V_{OC} = 9V
V_{OUT} = 12V
R_{IN} = 20Ω
C_{IN} = 33µF

V_{IN} Line Step Response in Fixed Frequency

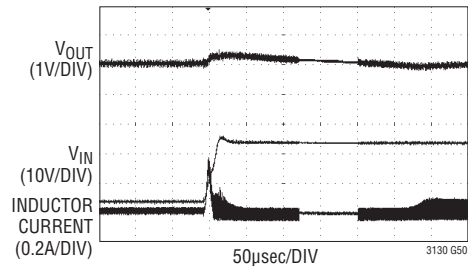

5V_{OUT},
5V TO 25V V_{IN} STEP,
C_{OUT} = 22µF, L = 10µH,
LIGHT LOAD

V_{IN} Line Step Response in Burst Mode Operation

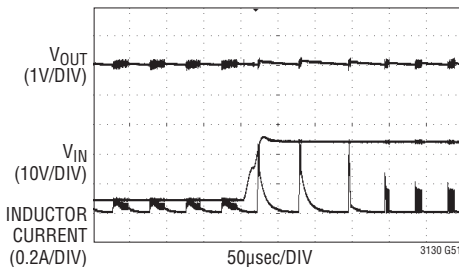

5V_{OUT},
5V TO 25V V_{IN} STEP,
C_{OUT} = 22µF, L = 10µH,
LIGHT LOAD

Output Voltage Short-Circuit Waveforms

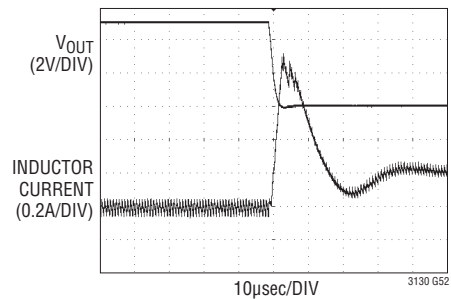

PIN FUNCTIONS (QFN/MSOP)

BST1 (Pin 1/Pin 2): Boot-Strapped Floating Supply for High Side NMOS Gate Drive. Connect to SW1 through a 22nF capacitor, as close to the part as possible.

PV_{IN} (Pin 2/Pin 4): Power Input for the Buck-Boost Converter. A 4.7μF or larger bypass capacitor should be connected between this pin and the ground plane. The capacitor should be located as close to the IC as possible. When powered through long leads or from a high ESR source, a larger bulk input capacitor (typically 47μF or larger) may be required.

V_{IN} (Pin 3/Pin 5): Input Voltage for the V_{CC} Regulator. Connect a minimum of 1μF ceramic decoupling capacitor from this pin to the ground plane.

RUN (Pin 4/Pin 6): Input to the Run Comparator. Raising this pin above 1.05V enables the converter. Pull this pin above 0.6V (typical) to put the converter in “standby mode”, where the internal reference will be enabled, but the part will not be switching. Connecting this pin to a resistor divider from V_{IN} to ground allows programming an accurate V_{IN} start threshold. To enable the converter all the time, tie RUN to V_{IN}. See the Operation section of this data sheet for more guidance.

V_{CC} (Pin 5/Pin 7): Output Voltage of the Internal 4V Voltage Regulator. This is the supply pin for the internal circuitry. Bypass this output with a minimum of 4.7μF ceramic capacitor. This internal regulator is powered by V_{IN} or EXT_V_{CC}. Note that V_{CC} should not be back-driven.

V_{CC} can be used to power external circuitry as long as the peak load current doesn't exceed 2mA. Note that this added load will increase the minimum required operating V_{IN} voltage by up to 60mV.

NC (Pin 17, QFN Only): Unused. This pin should be grounded.

MPPC (Pin 6/Pin 8): Maximum Power Point Control Programming Input. Connect this pin to a resistor divider from V_{IN} to ground to enable MPPC functionality. If the

divider voltage drops below 1.0V (typical), the inductor current will be reduced to servo V_{IN} to the programmed minimum voltage, as set by the divider. Note that this pin is very noise sensitive, therefore minimize trace length and stray capacitance. Refer to the Applications Information section of this data sheet for more detail on programming the MPPC. If this function is not needed, tie the pin to V_{CC}.

GND (Pins 7-8, Exposed Pad Pin 21/Pin 1, Exposed Pad Pin 17): Ground. Provide a short direct PCB path between GND and the ground plane that the exposed pad is soldered to. The exposed pad must be soldered to the PCB ground plane. It serves as a power ground connection, and as a means of conducting heat away from the die.

FB (Pin 9/Pin 9 (LTC3130)): Feedback input to the error amplifier. Connect to a resistor divider from V_{OUT} to ground. The output voltage can be adjusted from 1.0V to 25V by:

$$V_{OUT} = 1.00V \cdot \left(1 + \frac{R1}{R2} \right) \quad (\text{Refer to Figure 2})$$

Note that this pin is very noise sensitive, therefore minimize trace length and stray capacitance. Please refer to the Applications Information section of this data sheet for more detail on setting the FB voltage divider, and the optional use of an optional feed-forward capacitor.

VS2 (Pin 9/Pin 9 (LTC3130-1)): Output Voltage Select Pin. Connect this pin to ground or V_{CC} to program the output voltage (see Table 1). This pin can also be dynamically driven by any logic signal that satisfies the specified thresholds.

ILIM (Pin 10/Pin 10 (LTC3130)): Programming pin to select between 250mA or 660mA average minimum inductor current limit. Please see the Maximum Output Current curve in the Typical Performance Characteristics section.

ILIM = Low (ground): Sets the average inductor current limit to 250mA (minimum) for low current applications

ILIM = High (tie to V_{CC}): Sets the average inductor current limit to 660mA (minimum)

This pin can also be dynamically driven by any logic signal that satisfies the specified thresholds.

PIN FUNCTIONS (QFN/MSOP)

VS1 (Pin 10/Pin 10 (LTC3130-1)): Output Voltage Select Pin. Connect this pin to ground or V_{CC} to program the output voltage (see Table 1). This pin can also be dynamically driven by any logic signal that satisfies the specified thresholds.

Table 1. V_{OUT} Program Settings for the LTC3130-1

VS2	VS1	V_{OUT}
0	0	1.8V
0	V_{CC}	3.3V
V_{CC}	0	5.0V
V_{CC}	V_{CC}	12V

MODE (Pin 11/Pin 11): Mode Select Pin.

MODE = Low (ground): Enables automatic Burst Mode operation

MODE = High (tie to V_{CC}): Fixed frequency PWM operation

This pin can also be dynamically driven by any logic signal that satisfies the specified thresholds. There is an internal $3M\Omega$ pull-down resistor connected to MODE once switching is enabled, to prevent it from floating.

EXTV_{CC} (Pin 12/Pin 12): Second Input to the Internal V_{CC} Regulator. This pin can be tied to V_{OUT} or another voltage between 3V and 25V. If this input is used, it will power the IC, reducing the quiescent current draw on V_{IN} in buck applications and allowing the converter to operate from a V_{IN} voltage down to 1V or less. A $4.7\mu F$ decoupling capacitor is recommended on this pin unless it is tied directly to the V_{OUT} decoupling capacitor. **If not used, this pin should be grounded.**

PGOOD (Pin 13/Pin 13): Open-drain output that pulls to ground when FB (LTC3130) or V_{OUT} (LTC3130-1) drops too far below its regulated voltage. Connect a pull-up resistor from this pin to a positive supply. Note that if a supply voltage is present on V_{IN} or $EXTV_{CC}$, this pin will be forced low in shutdown or UVLO.

V_{OUT} (Pin 14/Pin 14): Output Voltage of the Converter. Connect a minimum value of $4.7\mu F$ ceramic capacitor from this pin to the ground plane. See the Applications Information section of this data sheet for guidance.

BST2 (Pin 16/Pin 15): Boot-Strapped Floating Supply for High Side NMOS Gate Drive. Connect to SW2 through a $22nF$ capacitor, as close to the part as possible.

SW2 (Pin 15/Pin 16): Switch Pin. Connect to the other side of the inductor. Keep PCB trace lengths as short and wide as possible to reduce EMI and parasitic resistance.

PGND (Pins 18-19)/(Pin 1): Power Ground. Provide a short direct PCB path between PGND and the ground plane.

SW1 (Pin 20/Pin 3): Switch Pin. Connect to one side of the inductor. Keep PCB trace lengths as short and wide as possible to reduce EMI and parasitic resistance.

LTC3130 BLOCK DIAGRAM

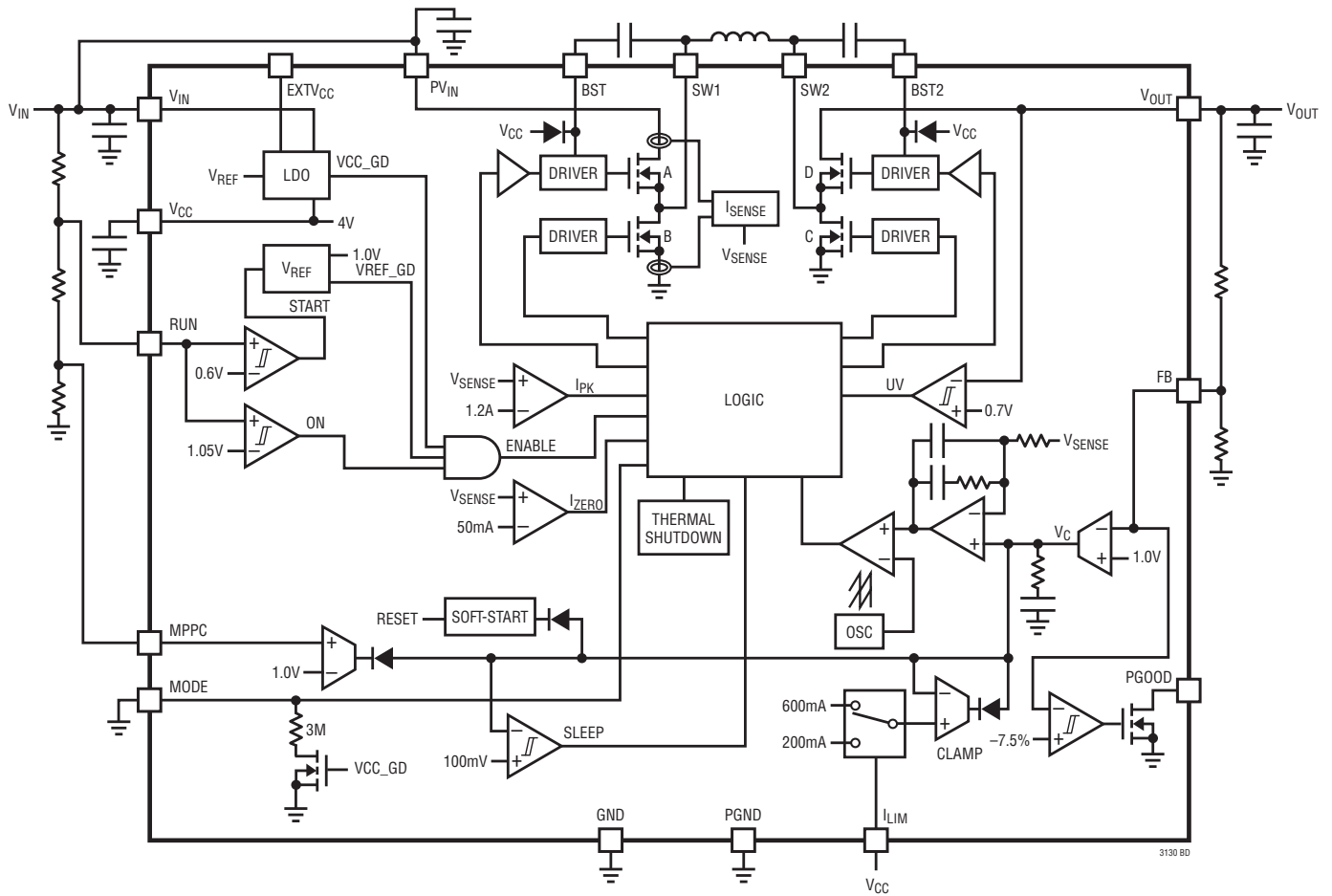

LTC3130-1 BLOCK DIAGRAM

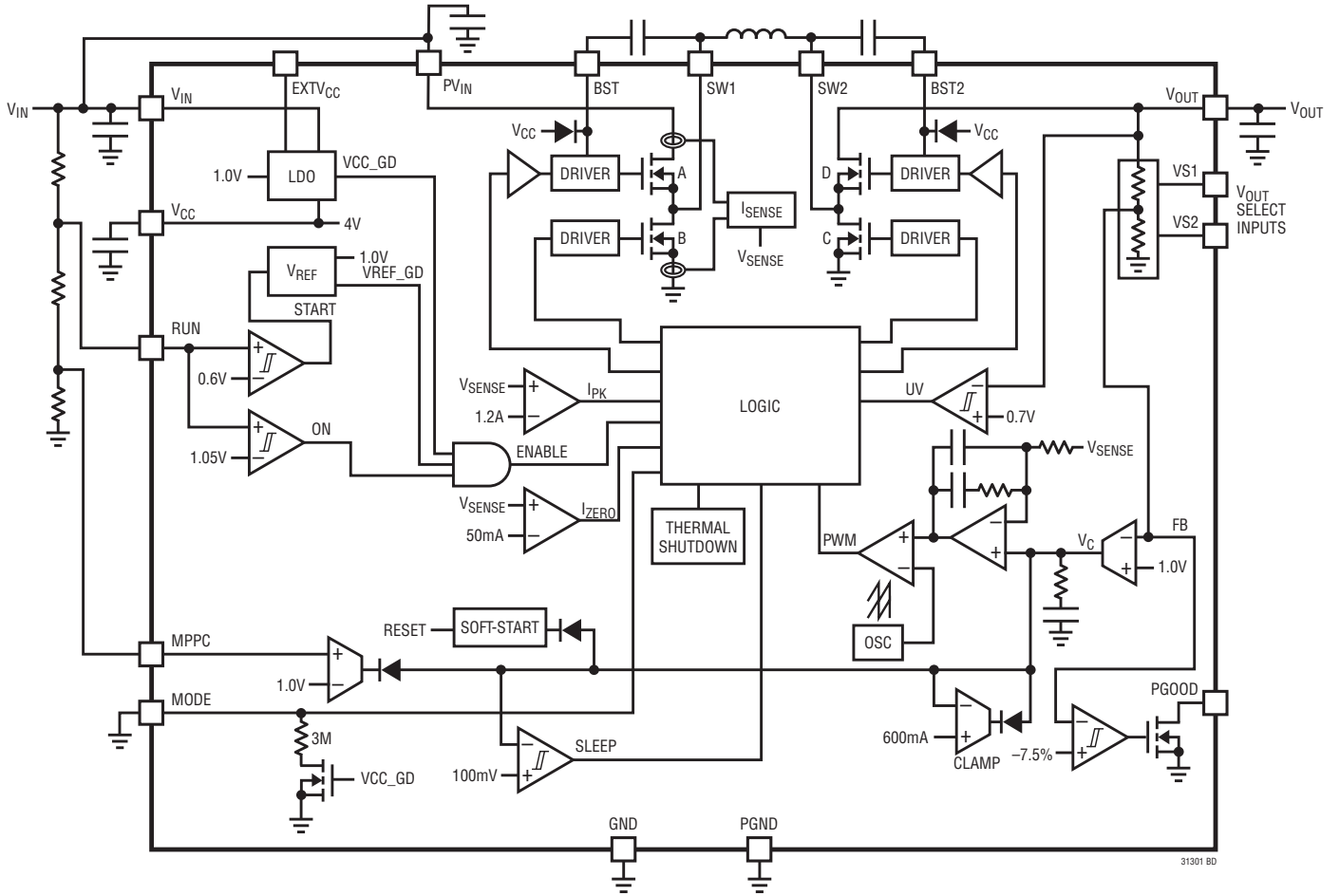

OPERATION

INTRODUCTION

The LTC3130/LTC3130-1 are 1.6 μ A quiescent current, monolithic, current mode, buck-boost DC/DC converters that can operate over a wide input voltage range of 0.6V (2.4V to start) to 25V and provide up to 600mA to the load. The LTC3130 has a FB pin for programming V_{OUT} anywhere from 1V to 25V, while the LTC3130-1 features four fixed, user-selectable output voltages which can be selected using the two digital programming pins. Internal, low $R_{DS(ON)}$ N-channel power switches reduce solution complexity and maximize efficiency. A proprietary switch control algorithm allows the buck-boost converter to maintain output voltage regulation with input voltages that are above, below or equal to the output voltage. Transitions between the step-up or step-down operating modes are seamless and free of transients and sub-harmonic switching, making this product ideal for noise sensitive applications. The LTC3130/LTC3130-1 operate at a fixed nominal switching frequency of 1.2MHz, which provides an ideal trade-off between small solution size and high efficiency. Current mode control provides inherent input line voltage rejection, simplified compensation and rapid response to load transients.

Burst Mode capability is included in the LTC3130/LTC3130-1 and is user-selected via the MODE pin. In Burst Mode operation, exceptional light-load efficiency is achieved by operating the converter only when necessary to maintain voltage regulation. The Burst Mode quiescent current is a miserly 1.6 μ A. When Burst Mode operation is selected, the converter automatically switches to fixed frequency PWM mode at higher loads. (Please refer to the Typical Performance Characteristic curves for the mode transition point at different input and output voltages.) If the application requires extremely low noise under all load conditions, continuous PWM operation can also be selected via the MODE pin by pulling it high.

A MPPC (maximum power point control) function is also provided that prevents the converter from pulling enough current to drop V_{IN} below a user-programmed threshold under load. This servos the input voltage of the converter to a programmable point for maximum power extraction when operating from various non-ideal power sources such as photovoltaic cells.

The LTC3130/LTC3130-1 also feature an accurate RUN comparator threshold with hysteresis, allowing the buck/boost DC/DC converter to turn on and off at user-programmed V_{IN} voltage thresholds. With a wide voltage range, 1.6 μ A Burst Mode current and programmable RUN and MPPC pins, these highly integrated monolithic converters are well suited for many diverse applications.

PWM MODE OPERATION

If the MODE pin is high (or if the load current on the converter is high enough to command PWM mode operation with MODE low), the LTC3130/LTC3130-1 operate in a fixed 1.2MHz PWM mode using an internally compensated average current mode control loop. PWM mode minimizes output voltage ripple and yields a low noise switching frequency spectrum. A proprietary switching algorithm provides seamless transitions between operating modes and eliminates discontinuities in the average inductor current, inductor ripple current and loop transfer function throughout all modes of operation. These advantages result in increased efficiency, improved loop stability and lower output voltage ripple in comparison to the traditional buck-boost converter.

Figure 1 shows the topology of the power stage which is comprised of four N-channel DMOS switches and their associated gate drivers. In PWM mode operation both switch pins transition on every cycle independent of the input and output voltages. In response to the internal control loop command, an internal pulse width modulator generates the appropriate switch duty cycle to maintain regulation of the output voltage.

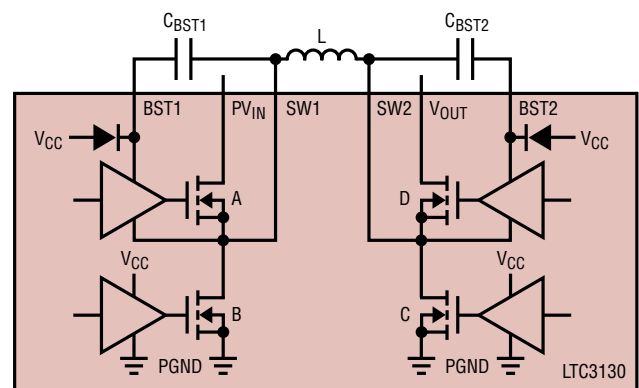

Figure 1. Power Stage Schematic

3130 F01

OPERATION

When stepping down from a high input voltage to a lower output voltage, the converter operates in buck mode and switch D remains on for the entire switching cycle except for the minimum switch low duration (typically 70ns). During the switch low duration, switch C is turned on which forces SW2 low and charges the flying capacitor, C_{BST2} . This ensures that the switch D gate driver power supply rail on BST2 is maintained. The duty cycle of switches A and B are adjusted to maintain output voltage regulation in buck mode.

If the input voltage is lower than the output voltage, the converter operates in boost mode. Switch A remains on for the entire switching cycle except for the minimum switch low duration (typically 70ns). During the switch low duration, switch B is turned on which forces SW1 low and charges the flying capacitor, C_{BST1} . This ensures that the switch A gate driver power supply rail on BST1 is maintained. The duty cycle of switches C and D are adjusted to maintain output voltage regulation in boost mode.

Oscillator

The LTC3130/LTC3130-1 operate from an internal oscillator with a nominal fixed frequency of 1.2MHz. This allows the DC/DC converter efficiency to be maximized while still using small external components.

Current Mode Control

The LTC3130/LTC3130-1 utilizes average current mode control for the pulse width modulator. Current mode control, both average and the better known peak method, enjoy some benefits compared to other control methods including: simplified loop compensation, rapid response to load transients and inherent line voltage rejection.

Referring to the Block Diagrams, a high gain, internally compensated transconductance voltage error amplifier monitors V_{OUT} through a voltage divider connected to the FB pin (LTC3130) or via the internal V_{OUT} voltage divider (LTC3130-1). The error amplifier output is used by the current mode control loop to command the appropriate inductor current level. The inverting input of the internally compensated average current amplifier is connected to the inductor current sense circuit. The average current amplifier's output is compared to the oscillator ramps,

and the comparator outputs are used to control the duty cycle of the switch pins on a cycle-by-cycle basis.

The voltage error amplifier makes adjustments to the current command as necessary to maintain V_{OUT} in regulation. The voltage error amplifier therefore controls the outer voltage regulation loop. The average current amplifier makes adjustments to the inductor current as directed by the voltage error amplifier, and is commonly referred to as the inner current loop amplifier.

The average current mode control technique is similar to peak current mode control except that the average current amplifier, by virtue of its configuration as an integrator, controls average current instead of the peak current. This difference eliminates the peak to average current error inherent to peak current mode control, while maintaining most of the advantages inherent to peak current mode control.

The compensation components required to ensure proper operation have been carefully selected and are integrated within the LTC3130/LTC3130-1.

Inductor Current Sense and Maximum Average Output Current

As part of the current control loop required for current mode control, the LTC3130/LTC3130-1 include a pair of current sensing circuits that measure the buck-boost converter inductor current.

The voltage error amplifier output (V_C) is internally clamped to an accurate threshold. Since the average inductor current is proportional to V_C , the clamp level sets the maximum average inductor current that can be programmed by the inner current loop. Taking into account the current sense amplifier's gain, the maximum average inductor current is approximately 850mA typical (660mA minimum, assuming the ILIM pin is pulled high for the LTC3130). In buck mode, the output current is approximately equal to 90% of the inductor current I_L (due to the forced low time of the B and C switches, where no current is delivered to the output):

$$I_{OUT(BUCK)} \approx 0.9 \cdot I_L$$

OPERATION

In boost mode, the output current is related to average inductor current and duty cycle by:

$$I_{\text{OUT(BOOST)}} \approx I_L \cdot \left(\frac{V_{\text{IN}}}{V_{\text{OUT}}} \right) \cdot \eta$$

Since the output current in boost mode is reduced by the step-up ratio of $V_{\text{IN}}/V_{\text{OUT}}$, the output current rating in buck mode is always greater than in boost mode. Also, because boost mode operation requires a higher inductor current for a given output current compared to buck mode, the efficiency (η) in boost mode will generally be lower due to higher $I_L^2 \cdot R_{\text{DS(ON)}}$ losses in the power switches. This will further reduce the output current capability in boost mode. In either operating mode, however, the inductor peak-to-peak ripple current does not play a major role in determining the output current capability, unlike peak current mode control.

The LTC3130/LTC3130-1 measure and control average inductor current, and therefore, the inductor ripple current magnitude has little effect on the maximum current capability (in contrast to an equivalent peak current mode converter). Under most conditions in buck mode, the LTC3130/LTC3130-1 are capable of providing a minimum of 600mA to the load. Refer to the Typical Performance Characteristics section for more details. In boost mode, as described previously, the output current capability is related to the boost ratio. For example, for a 5V V_{IN} to 15V output application, the LTC3130/LTC3130-1 can provide up to 150mA typical to the load. Refer to the Typical Performance Characteristics section for more detail on output current capability.

Programming V_{OUT} (LTC3130)

The output voltage of the LTC3130 is programmed using an external resistor divider from V_{OUT} to ground with the divider tap connected to the FB pin, as shown in Figure 2, according to the equation:

$$V_{\text{OUT}} = 1.00\text{V} \cdot \left(1 + \frac{R1}{R2} \right) \quad (\text{Refer to Figure 2})$$

The output voltage can be set anywhere from 1.0V to 25V.

An optional feed-forward capacitor can be added in parallel with R1 (as shown in Figure 2) to reduce Burst Mode ripple and improve transient response of the voltage loop. The typical feed-forward capacitor value can be calculated by:

$$C_{\text{FF}} (\text{pF}) = \frac{40}{R1 (\text{Meg})}$$

In some applications, where the voltage-loop bandwidth is high, it may prove beneficial to add a resistor in series with the feed-forward capacitor to limit the high frequency gain. The value isn't critical, and resistor values of

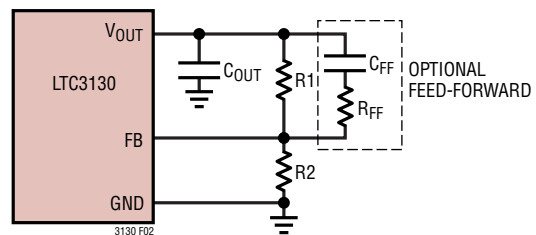

Figure 2. V_{OUT} Feedback Divider (Showing Optional Feed-Forward Capacitor)

approximately $R1/20$ are generally recommended.

V_{OUT} Programming Pins (LTC3130-1)

The LTC3130-1 has a precision internal voltage divider on V_{OUT} , eliminating the need for high value external feedback resistors. This not only eliminates two external components, it minimizes no-load quiescent current by using very high resistance values that would not be practical when used externally due to the effects of noise and board leakages that would cause V_{OUT} regulation errors. The tap point on this divider is digitally selected by using the VS1 and VS2 pins to program one of four fixed output voltages.

The VS1 and VS2 pins can be grounded or connected to V_{CC} to select the desired output voltage, according to Table 1. They can also be driven dynamically from external logic signals, as long as the pin's specified logic levels are satisfied and the absolute maximum ratings for the pins are not exceeded.

OPERATION

Note that driving VS1 or VS2 to a logic high that is below the V_{CC} voltage can result in an increase of up to $1\mu\text{A}$ of current draw from V_{CC} per VS pin. This does not occur in shutdown or if V_{CC} is below its UVLO threshold, in which case these inputs are disabled and will not cause any extra current draw.

Table 1. V_{OUT} Program Settings for the LTC3130-1

VS2	VS1	V_{OUT}
0	0	1.8V
0	V_{CC}	3.3V
V_{CC}	0	5.0V
V_{CC}	V_{CC}	12V

Programming the ILIM Threshold (LTC3130 only)

The LTC3130 has two average current limit settings, which are set by the ILIM pin. If ILIM is pulled high (tied to V_{CC}), the average inductor current limit will be set to 660mA (minimum). If the ILIM pin is pulled low (tied to ground), the average inductor current limit will be reduced to 250mA (minimum). This setting can be used in low power applications to reduce the maximum current draw from sources that may suffer excessive voltage drop at the full 600mA current limit setting, or to simply reduce the maximum output current.

V_{OUT} Undervoltage and Foldback Current Limit

The LTC3130/LTC3130-1 include a foldback current limit feature to reduce power dissipation into a shorted output. When V_{OUT} is less than 0.7V (typical), the average current limit is reduced to about half of its normal value. In the case of the LTC3130 with the ILIM pin set low, the average inductor current limit has already been cut in half and will not be further reduced during undervoltage.

Overload Peak Current Limit

The LTC3130/LTC3130-1 also have peak overload current (I_{PEAK}) and zero current (I_{ZERO}) comparators. The I_{PEAK} current comparator turns off switch A for the remainder of the switching cycle if the inductor current exceeds the maximum threshold of 1.3A (typical). An inductor current

level of this magnitude may occur during a fault, such as an output short circuit, or possibly for a few cycles during large load or input voltage transients. Note that it may also occur if there is excessive inductor ripple current (or inductor saturation) due to an improperly sized inductor.

Note that if a peak current limit is reached while V_{OUT} is also less than 0.7V typical (which would be indicative of a shorted output), a soft-start cycle will be triggered.

I_{ZERO} Comparator

The LTC3130/LTC3130-1 feature near discontinuous inductor current operation at light output loads by virtue of the I_{ZERO} comparator circuit. By limiting the reverse current magnitude in PWM mode, a balance between low noise operation and improved efficiency at light loads is achieved. The I_{ZERO} threshold is set near the zero current level in PWM mode, and as a result the reverse current magnitude will be a function of inductance value and output voltage due to the comparator's propagation delay. In general, higher output voltages and lower inductor values will result in increased peak reverse current.

In automatic Burst Mode operation (MODE pin low), the I_{ZERO} threshold is increased so that reverse inductor current does not normally occur. This maximizes efficiency at light loads.

Note that reverse current is also inhibited during soft-start (regardless of the MODE pin setting) to prevent V_{OUT} discharge when starting up into pre-biased outputs.

Burst Mode OPERATION

When the MODE pin is held low, the LTC3130/LTC3130-1 are configured for automatic Burst Mode operation. As a result, the buck-boost DC/DC converter will operate with normal continuous PWM switching above a predetermined minimum output load and will automatically transition to power saving Burst Mode operation below this output load level. Refer to the Typical Performance Characteristics section of this data sheet to determine the Burst Mode transition threshold for various combinations of V_{IN} and V_{OUT} .

OPERATION

If MODE is low, at light output loads, the LTC3130/LTC3130-1 go into a standby or sleep state when the output voltage achieves its nominal regulation level. The sleep state halts PWM switching and powers down all non-essential functions of the IC, significantly reducing the quiescent current of the converter to just 1.6 μ A typical. This greatly improves overall power conversion efficiency when the output load is light. Since the converter is not operating in sleep, the output voltage will slowly decay at a rate determined by the output load current and the output capacitor value. When the output voltage has decayed by a small amount, the LTC3130/LTC3130-1 wake and resume normal PWM switching operation until the voltage on V_{OUT} is restored to the previous level. If the load is very light, the converter may only need to switch for a few cycles to restore V_{OUT} and may sleep for extended periods of time, significantly improving efficiency. If the load is suddenly increased above the burst transition threshold, the part will automatically resume continuous PWM operation until the load is once again reduced.

Note that Burst Mode operation is inhibited until soft-start is done, the MPPC pin is greater than 1.05V and V_{OUT} has reached 95% of regulation.

Soft-Start

The LTC3130/LTC3130-1 soft-start circuit minimizes input current transients and output voltage overshoot on initial power up. The required timing components for soft-start are internal to the IC and produce a nominal average current limit soft-start duration of approximately 12ms. The internal soft-start circuit slowly ramps the error amplifier output. In doing so, the maximum average inductor current is also slowly increased, starting from zero. Soft-start is reset if the RUN pin drops below the accurate run threshold, V_{CC} drops below its UVLO threshold, a thermal shutdown occurs, or a peak current limit occurs while V_{OUT} is less than 0.7V typical.

Note that because the average current limit is being soft-started, the V_{OUT} rise time will be load dependent, and is typically less than 12ms.

V_{CC} Regulator and EXTV $_{CC}$ Input

An internal low dropout regulator (LDO) generates a nominal 4V V_{CC} rail from V_{IN} , or from EXTV $_{CC}$ if a valid EXTV $_{CC}$ voltage is present. The V_{CC} rail powers the internal control circuitry and the gate drivers of the LTC3130/LTC3130-1. The V_{CC} regulator is enabled even in shutdown, but will regulate to a lower voltage. The V_{CC} regulator includes current-limit protection to safeguard against accidental short-circuiting of the V_{CC} rail. V_{CC} should be decoupled with a 4.7 μ F ceramic capacitor located close to the IC.

During start-up, the IC will choose the higher of V_{IN} or EXTV $_{CC}$ to generate V_{CC} . Once V_{CC} is above its rising UVLO threshold, EXTV $_{CC}$ will continue to be used if it is above 3.0V typical, otherwise V_{IN} will be used. This allows start-up from low V_{IN} sources (in applications where a valid EXTV $_{CC}$ voltage is present), while minimizing LDO power dissipation after start-up in applications where V_{IN} may be much higher than V_{CC} .

Use of the EXTV $_{CC}$ input allows the converter to operate from V_{IN} voltages less than 1V, as long as EXTV $_{CC}$ is held in its operating range of 3.0V minimum and 25V maximum. If EXTV $_{CC}$ is tied to V_{OUT} in buck applications, it will also reduce the input current drawn from V_{IN} , thereby increasing converter efficiency, especially at light loads.

If an independent source, such as a battery or another supply rail, is used to power EXTV $_{CC}$, then the IC can start up and operate at any input voltage, from 25V down to (theoretically) 0V (assuming the RUN pin is held above 1.05V). In practice, the minimum V_{IN} voltage capability will be application specific, determined by the required output voltage and output current of the converter. Due to the rapid drop in efficiency at very low input voltages, the practical V_{IN} limit is usually around 0.6V, assuming a low resistance source, and that the step-up ratio to V_{OUT} doesn't become duty cycle limited. Refer to the Typical Performance Characteristic curves for the output voltage and current capability versus V_{IN} .

If not used, EXTV $_{CC}$ should be grounded.

OPERATION

Undervoltage Lockout (UVLO)

The V_{CC} UVLO has a falling voltage threshold of 2.175V (typical). If the V_{CC} voltage falls below this threshold, IC operation is disabled until V_{CC} rises above 2.30V (typical).

Therefore, if a valid voltage source is not present on $EXTV_{CC}$, the minimum V_{IN} for the part to start up is 2.30V (typical).

Note that until V_{CC} is above the UVLO threshold, the part will remain in a low quiescent current state (1.4 μ A typical). This facilitates start-up from very weak sources.

RUN Pin Comparator

When RUN is driven above its logic threshold (0.6V typical), the internal voltage reference and the PGOOD circuit are enabled (assuming V_{CC} is above 2.30V typical). If the voltage on RUN is increased further so that it exceeds the RUN comparator's accurate rising threshold (1.05V typical), all functions of the buck-boost converter will be enabled and a start-up sequence will ensue. The RUN pin comparator has 100mV of hysteresis, so operation will be inhibited if the pin drops below 0.95V.

Therefore, with the addition of an optional resistor divider as shown in Figure 3, the RUN pin can be used to establish user-programmable turn-on and turn-off (UVLO) thresholds. This feature can be utilized to minimize battery drain below a programmed input voltage, or to operate the converter in a hiccup mode from very low current sources.

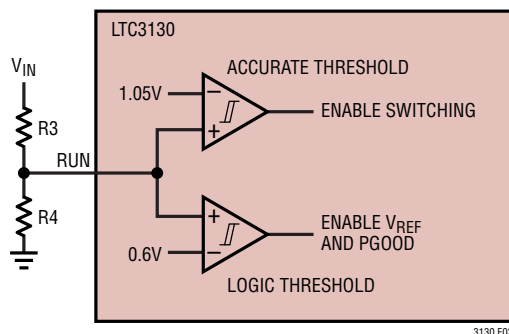

Figure 3. Accurate RUN Pin Comparator

If RUN is brought below the accurate comparator falling threshold, the buck-boost converter will inhibit switching, but the V_{CC} regulator and control circuitry will remain powered. In this state, the typical V_{IN} quiescent current is only 1.4 μ A, in order to completely shut down the IC and reduce the V_{IN} current to 500nA (typical), it is necessary to ensure that RUN is brought below its minimum low logic threshold of 0.2V.

RUN can be tied directly to V_{IN} to continuously enable the IC when the input supply is present. Also note that RUN can be driven above V_{IN} or V_{OUT} as long as it stays within the absolute maximum rating of 25V.

The converter is enabled when the voltage on RUN exceeds 1.05V (nominal). Therefore, the turn-on voltage threshold on V_{IN} is given by:

$$V_{IN(TURNON)} = 1.05V \cdot \left(1 + \frac{R3}{R4}\right)$$

Once the converter is enabled, the RUN comparator includes a built-in hysteresis of 100mV, so that the turn-off threshold will be :

$$V_{IN(TURNOFF)} = 0.95V \cdot \left(1 + \frac{R3}{R4}\right)$$

The RUN comparator is designed to be relatively noise insensitive, but there may be cases due to PCB layout, very large value resistors for R3 and R4, or proximity to noisy components where noise pickup is unavoidable and may cause the turn-on or turn-off of the IC to be intermittent. In these cases, a small filter capacitor can be added across R4.

PGOOD Comparator

The LTC3130/LTC3130-1 provide an open-drain PGOOD output that pulls low if FB (LTC3130) or V_{OUT} (LTC3130-1) falls more than 7.5% (typical) below its programmed value. When V_{OUT} rises to within 5% (typical) of its programmed value, the internal PGOOD pull-down will turn off and PGOOD will go high if an external pull-up resistor has been provided. An internal filter prevents

OPERATION

nuisance trips of PGOOD due to short transients on V_{OUT} . PGOOD can be pulled up to any voltage, as long as the absolute maximum rating of 25V is not exceeded, and as long as the absolute maximum sink current rating of 12mA is not exceeded when PGOOD is low.

Note that PGOOD will be driven low if V_{CC} is below its UVLO threshold or if the part is in shutdown (RUN below its logic threshold). PGOOD is not affected by the accurate RUN threshold. Therefore, if PGOOD is pulled up to V_{IN} or V_{CC} , this will add to the V_{IN} quiescent current in shutdown and UVLO, when PGOOD is low. For the lowest possible V_{IN} current in shutdown or UVLO, PGOOD should be pulled up to V_{OUT} or some other source.

Maximum Power Point Control (MPPC)

The MPPC input of the LTC3130/LTC3130-1 can be used with an optional external voltage divider to dynamically adjust the commanded inductor current in order to maintain a minimum input voltage when using high resistance sources, such as photovoltaic panels, so as to maximize input power transfer and prevent V_{IN} from dropping too low under load.

Referring to Figure 4, the MPPC pin is internally connected to the noninverting input of a g_m amplifier, whose inverting input is connected to the 1.0V reference. If the voltage at MPPC, using the external voltage divider, falls below the reference voltage, the output of the amplifier pulls the internal VC node low. This reduces the commanded average inductor current so as to reduce the input current and regulate V_{IN} to the programmed minimum voltage, as given by:

$$V_{IN(MPPC)} = 1.00V \cdot \left(1 + \frac{R5}{R6} \right)$$

Note that external compensation should not be required for MPPC loop stability if the input filter capacitor, C_{IN} , is at least 22 μ F.

The MPPC divider resistor values can be in the M Ω range so as to minimize the input current in very low power applications. However, stray capacitance and noise pickup on the MPPC pin must also be minimized. If the MPPC function is not required, the MPPC pin should be tied to V_{CC} .

Beware of adding a noise filter capacitor to the MPPC pin, as the added filter pole may cause the MPPC control loop to be unstable.

Note that because Burst Mode operation will be inhibited if the MPPC loop takes control, the converter will be operating in fixed frequency mode, and will therefore require a minimum of about 6mA of continuous input current to operate. For operation from weaker sources, such as small indoor solar panels, refer to the Applications Information section to see how the RUN pin may be programmed to control the converter in a hysteretic manner while providing an effective MPPC function by maintaining V_{IN} at the desired voltage. This technique can be used with sources as weak as 3 μ A (enough to power the IC in UVLO and the external RUN divider).

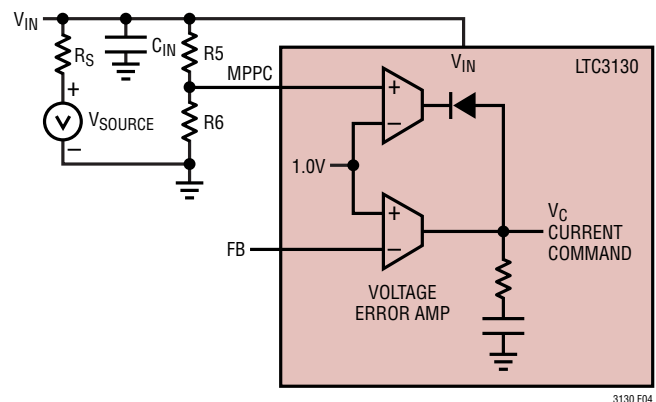

Figure 4. MPPC Amplifier with External Resistor Divider

APPLICATIONS INFORMATION

A standard application circuit for the LTC3130-1 is shown on the front page of this data sheet. There are numerous other application examples for both the LTC3130-1 and LTC3130 shown in the Typical Applications section of this data sheet.

The appropriate selection of external components is dependent upon the required performance of the IC in each particular application given considerations and trade-offs such as PCB area, input and output voltage range, output voltage ripple, transient response, required efficiency, thermal considerations and cost. This section of the data sheet provides some basic guidelines and considerations to aid in the selection of external components and the design of the applications circuit, as well as more application circuit examples.

V_{CC} Capacitor Selection

The V_{CC} output of the LTC3130/LTC3130-1 is generated from V_{IN} or EXT_V_{CC} by a low dropout linear regulator. The V_{CC} regulator has been designed for stable operation with a wide range of output capacitors. For most applications, a low ESR capacitor of at least 4.7μF should be used. The capacitor should be located as close to the V_{CC} pin as possible and connected to the V_{CC} pin and ground through the shortest traces possible. V_{CC} is the regulator output and is also the internal supply pin for the IC control circuitry as well as the gate drivers and boost rail charging diodes.

Inductor Selection

The choice of inductor used in LTC3130/LTC3130-1 application circuits influences the maximum deliverable output current, the converter bandwidth, the magnitude of the inductor current ripple and the overall converter efficiency. The inductor must have a low DC series resistance or output current capability and efficiency will be compromised. Larger inductor values reduce inductor current ripple but do not increase output current capability as is the case with peak current mode control. Larger value inductors also tend to have a higher DC series resistance

for a given case size, which will have a negative impact on efficiency. Larger values of inductance will also lower the right half plane (RHP) zero frequency when operating in boost mode, which can compromise loop stability. Nearly all LTC3130/LTC3130-1 application circuits deliver the best performance with an inductor value between 3.3μH and 15μH, depending on V_{IN} and V_{OUT}. Buck mode only applications can use the larger inductor values as they are unaffected by the RHP zero, while mostly boost applications generally require inductance on the low end of this range depending on how large the step-up ratio is.

Regardless of inductor value, the saturation current rating should be selected such that it is greater than the worst-case average inductor current plus half of the ripple current. The peak-to-peak inductor current ripple for each operational mode can be calculated from the following formula, where f is the switching frequency (1.2MHz), L is the inductance in μH and t_{LOW} is the switch pin minimum low time in μs. The switch pin minimum low time is typically 0.07μs.

$$\Delta I_{L(P-P)(BUCK)} = \frac{V_{OUT}}{L} \left(\frac{V_{IN} - V_{OUT}}{V_{IN}} \right) \left(\frac{1}{f} - t_{LOW} \right) \text{ Amps}$$

$$\Delta I_{L(P-P)(BOOST)} = \frac{V_{IN}}{L} \left(\frac{V_{OUT} - V_{IN}}{V_{OUT}} \right) \left(\frac{1}{f} - t_{LOW} \right) \text{ Amps}$$

It should be noted that the worst-case peak-to-peak inductor ripple current occurs when the duty cycle in buck mode is minimum (highest V_{IN}) and in boost mode when the duty cycle is 50% (V_{OUT} = 2 • V_{IN}). As an example, if V_{IN} (minimum) = 2.5V and V_{IN} (maximum) = 15V, V_{OUT} = 5V and L = 10μH, the peak-to-peak inductor ripples at the voltage extremes (15V V_{IN} for buck and 2.5V V_{IN} for boost) are:

Buck = 251mA peak-to-peak

Boost = 94mA peak-to-peak

One-half of this inductor ripple current must be added to the highest expected average inductor current in order to select the proper saturation current rating for the inductor.

APPLICATIONS INFORMATION

To minimize core losses and to prevent high inductor current ripple from tripping the peak current limit before the average current limit is reached, an inductor value with a ΔI_L of less than 500mA P-P should be chosen. For loads that operate well below current limit, higher inductor ripple can be tolerated to allow the use of a lower value inductor.

To avoid the possibility of inductor saturation during load transients, an inductor with a saturation current rating of at least 1200mA is recommended for all applications (unless the ILIM pin of the LTC3130 is set low, in which case a 650mA rated inductor may be used).

Note that in boost mode, especially at large step-up ratios, the output current capability is often limited by the total resistive losses in the power stage. These losses include switch resistances, inductor DC resistance and PCB trace resistance. Avoid inductors with a high DC resistance (DCR) as they can degrade the maximum output current capability from what is shown in the Typical Performance Characteristics section and from the Typical Application circuits.

As a guideline, the inductor DCR should be significantly less than the typical power switch resistance of 350m Ω . The only exceptions are applications that have a maximum output current much less than what the LTC3130/LTC3130-1 are capable of delivering. Generally speaking, inductors with a DCR in the range of 0.05 Ω to 0.15 Ω are recommended. Lower values of DCR will improve the efficiency at the expense of size, while higher DCR values will reduce efficiency (typically by a few percent) while allowing the use of a physically smaller inductor.

Different inductor core materials and styles have an impact on the size and price of an inductor at any given current rating. Shielded construction is generally preferred as it minimizes the chances of interference with other circuitry. The choice of inductor style depends upon the price, sizing, and EMI requirements of a particular application.

Table 2 provides a wide sampling of inductor families from different manufacturers that are well suited to LTC3130/LTC3130-1 applications. However, be sure to check the

current rating and DC resistance for the particular value you need, as not all of the inductor values in a given family will be suitable.

Table 2. Recommended Inductors

VENDOR	PART NUMBER FAMILY
Coilcraft coilcraft.com	EPL3015, LPS3314, LPS4012, LPS4018, XFL3012, XFL4020, MSS4020
Coiltronics cooperindustries.com	SD3814, SD3118, SD52
Murata murata.com	LQH43P, LQH44P
Sumida sumida.com	CDRH2D18, CDRH3D14, CDRH3D16, CDRH4D14
Taiyo-Yuden t-yuden.com	NR3012T, NR3015T, NRS4012T, NR4018T
TDK tdk.com	VLF252015MT, VLF302510MT, VLF302512MT, VLS3015ET, VLFC4018T, VLFC4020T, SPM4012T
Toko tokoam.com	DB318C, DB320C, DEM2815C, DEM3512C, DEM3518C
Würth we-online.com	WE-TPC 2818, WE-TPC 3816

Recommended maximum inductor values and minimum output capacitor values, for different output voltage ranges are given in Table 3 as a guideline. These values were chosen to minimize inductor size while ensuring loop stability over the entire load range of the converter.

Table 3. Recommended Inductor and Output Capacitor Values

V _{OUT} (V)	L _{MAX} (μ H)	MINIMUM RECOMMENDED OUTPUT CAPACITANCE (μ F)	
		LTC3130-1/LTC3130 WITH FEED FORWARD	LTC3130 PWM AND NO FEED-FORWARD
1 – 2.4	4.7	40	20
2.5 – 3.9	6.8	30	15
4 – 6.5	10	20	10
6.6 – 14	15	20	10
14 – 25	15	10	5

Note that many applications will be able to use a lower inductor value, depending on the input voltage range and resulting inductor current ripple. Lower inductor values will also allow the use of a smaller output capacitor value without compromising loop stability.

APPLICATIONS INFORMATION

Output Capacitor Selection

A low effective series resistance (ESR) output capacitor of 10 μ F minimum should be connected at the output of the buck-boost converter in order to minimize output voltage ripple. Multilayer ceramic capacitors are an excellent option as they have low ESR and are available in small footprints. The capacitor value should be chosen large enough to reduce the output voltage ripple to acceptable levels. Neglecting the capacitor's ESR and ESL (effect series inductance), the peak-to-peak output voltage ripple can be calculated by the following formula, where f is the frequency in MHz (1.2MHz), C_{OUT} is the capacitance in μ F, t_{LOW} is the switch pin minimum low time in μ s (0.07 μ s) and I_{LOAD} is the output current in Amps:

$$\Delta V_{P-P(BUCK)} = \frac{I_{LOAD} t_{LOW}}{C_{OUT}} \text{ Volts}$$

$$\Delta V_{P-P(BOOST)} = \frac{I_{LOAD}}{f C_{OUT}} \left(\frac{V_{OUT} - V_{IN} + t_{LOW} f V_{IN}}{V_{OUT}} \right) \text{ Volts}$$

Examining the previous equations reveal that the output voltage ripple increases with load current and is generally higher in boost mode than in buck mode. Note that these equations only take into account the voltage ripple that occurs from the inductor current to the output being discontinuous. They provide a good approximation of the ripple at any significant load current but underestimate the output voltage ripple at very light loads where the output voltage ripple is dominated by the inductor current ripple.

In addition to the output voltage ripple generated across the output capacitance, there is also output voltage ripple produced across the internal resistance of the output capacitor. The ESR-generated output voltage ripple is proportional to the series resistance of the output capacitor and is given by the following expressions where R_{ESR} is

the series resistance of the output capacitor and all other terms as previously defined:

$$\Delta V_{P-P(BUCK)} = \frac{I_{LOAD} R_{ESR}}{1 - t_{LOW} f} \cong I_{LOAD} R_{ESR} \text{ Volts}$$

$$\Delta V_{P-P(BOOST)} = \frac{I_{LOAD} R_{ESR} V_{OUT}}{V_{IN} (1 - t_{LOW} f)} \\ \cong I_{LOAD} R_{ESR} \left(\frac{V_{OUT}}{V_{IN}} \right) \text{ Volts}$$

In most LTC3130/LTC3130-1 applications, an output capacitor between 10 μ F and 47 μ F will work well. To minimize output ripple in Burst Mode operation, or transients incurred by large step loads, values of 22 μ F or larger are recommended.

Input Capacitor Selection

The PV_{IN} pin carries the full inductor current, while the V_{IN} pin provides power to internal control circuits in the IC. To minimize input voltage ripple and ensure proper operation of the IC, a low ESR bypass capacitor with a value of at least 4.7 μ F should be located as close to the PV_{IN} pin as possible. The V_{IN} pin should be bypassed with a 1 μ F ceramic capacitor located close to the pin, and Kelvined to "quiet side" of the primary V_{IN} decoupling capacitor. Do not tie the V_{IN} pin directly to PV_{IN} pin.

When powered through long leads or from a power source with any significant resistance, an additional, larger value bulk input capacitor may be required and is generally recommended. In such applications, a 47 μ F to 100 μ F low ESR electrolytic capacitor in parallel with the 4.7 μ F ceramic capacitor generally yields a high performance, low cost solution.

For applications using the MPPC feature, a minimum C_{IN} capacitor value of 22 μ F is recommended. Larger values can be used without limitation.

APPLICATIONS INFORMATION

Recommended Input and Output Capacitor Types

The capacitors used to filter the input and output of the LTC3130/LTC3130-1 must have low ESR and must be rated to handle the AC currents generated by the switching converter. This is important to maintain proper functioning of the IC and to reduce output voltage ripple. There are many capacitor types that are well suited to these applications including multilayer ceramic, low ESR tantalum, OS-CON and POSCAP technologies. In addition, there are certain types of electrolytic capacitors such as solid aluminum organic polymer capacitors that are designed for low ESR and high AC currents and these are also well suited to some LTC3130/LTC3130-1 applications.

The choice of capacitor technology is primarily dictated by a trade-off between size, leakage current and cost. In backup power applications, the input or output capacitor might be a super or ultra capacitor with a capacitance value measuring in the Farad range. The selection criteria in these applications are generally similar except that voltage ripple is generally not a concern.

Some capacitors exhibit a high DC leakage current which may preclude their consideration for applications that require a very low quiescent current in Burst Mode operation. Note that ultra capacitors may have a rather high ESR, therefore a 4.7 μ F (minimum) ceramic capacitor is recommended in parallel, close to the IC pins.

Beware of Capacitor DC Bias Effect

Ceramic capacitors are often utilized in switching converter applications due to their small size, low ESR and low leakage currents. However, many ceramic capacitors intended for power applications experience a significant loss in capacitance from their rated value as the DC bias voltage on the capacitor increases. It is not uncommon for a small surface mount capacitor to lose more than 50% of its rated capacitance when operated at even half of its maximum rated voltage. This effect is generally reduced as the case size is increased for the same nominal value capacitor. As a result, it is often necessary to use a larger

value capacitance or a higher voltage rated capacitor than would ordinarily be required to actually realize the intended capacitance at the operating voltage of the application. X5R and X7R dielectric types are recommended as they exhibit the best performance over the wide operating range and temperature of the LTC3130/LTC3130-1. To verify that the intended capacitance is achieved in the application circuit, be sure to consult the capacitor vendor's curve of capacitance versus DC bias voltage.

Using the Programmable RUN Function to Operate from Extremely Weak Input Sources

Another application of the programmable RUN pin is that it can be used to operate the converter in a "hiccup" mode from extremely weak sources. This allows operation from sources that can only generate microamps of output current, and would be far too weak to sustain normal steady-state operation, even with the use of the MPPC pin. Because the LTC3130/LTC3130-1 draw only 1.4 μ A typical from V_{IN} until they are enabled, the RUN pin can be programmed to keep the ICs disabled until V_{IN} reaches the programmed voltage level. In this manner, the input source can trickle-charge an input storage capacitor, even if it can only supply microamps of current, until V_{IN} reaches the turn-on threshold set by the RUN pin divider. The converter will then be enabled, using the stored charge in the input capacitor to power the converter and bring up V_{OUT} , until V_{IN} drops below the turn-off threshold, at which point the converter will turn off and the process will repeat.

This approach allows the converter to run from weak sources as small, thin-film solar cells using indoor lighting. Although the converter will be operating in bursts, it is enough to charge an output capacitor to power low duty cycle loads, such as in wireless sensor applications, or to trickle-charge a battery. In addition, note that the input voltage will be cycling (with 10% ripple as set by the UVLO hysteresis) about a fixed voltage, as determined by the divider. This allows the high impedance source to operate about the programmed optimal voltage for maximum power transfer.