



Chipsmall Limited consists of a professional team with an average of over 10 year of expertise in the distribution of electronic components. Based in Hongkong, we have already established firm and mutual-benefit business relationships with customers from,Europe,America and south Asia,supplying obsolete and hard-to-find components to meet their specific needs.

With the principle of "Quality Parts,Customers Priority,Honest Operation,and Considerate Service",our business mainly focus on the distribution of electronic components. Line cards we deal with include Microchip,ALPS,ROHM,Xilinx,Pulse,ON,Everlight and Freescale. Main products comprise IC,Modules,Potentiometer,IC Socket,Relay,Connector.Our parts cover such applications as commercial,industrial, and automotives areas.

We are looking forward to setting up business relationship with you and hope to provide you with the best service and solution. Let us make a better world for our industry!



## Contact us

Tel: +86-755-8981 8866 Fax: +86-755-8427 6832

Email & Skype: info@chipsmall.com Web: www.chipsmall.com

Address: A1208, Overseas Decoration Building, #122 Zhenhua RD., Futian, Shenzhen, China



# Wide $V_{IN}$ Range Buck-Boost Charge Pump with Watchdog Timer

## FEATURES

- 2.7V – 38V Operating Range (42V Abs Max)
- $I_Q = 20\mu\text{A}$  Operating,  $1.5\mu\text{A}$  in Shutdown
- Multimode Buck-Boost Charge Pump (2:1, 1:1, 1:2) with Automatic Mode Switching
- 12V to 5V Efficiency = 81%
- $I_{OUT}$  Up to 500mA
- $V_{OUT}$ : Fixed 3.3V, 5V or Adjustable (2.5V to 5V)
- Ultralow EMI Emissions
- Engineered for Diagnostic Coverage in ISO 26262 Systems
- Overtemperature, Overvoltage and Short-Circuit Protection
- Operating Junction Temperature:  $150^\circ\text{C}$  Max
- POR/Watchdog Controller w/External Timing Control
- Thermally Enhanced 16-Lead MSOP Package

## APPLICATIONS

- Automotive ECU/CAN Transceiver Supplies
- Industrial/Telecom Housekeeping Supplies
- Low Power 12V to 5V Conversion

## DESCRIPTION

The LTC3246 is a switched capacitor buck-boost DC/DC converter with integrated watchdog timer. The device produces a regulated output (3.3V, 5V or adjustable) from a 2.7V to 38V input. Switched capacitor fractional conversion is used to maintain regulation over a wide range of input voltage. Internal circuitry automatically selects the conversion ratio to optimize efficiency as input voltage and load conditions vary. No inductors are required.

The LTC3246's reset time and watchdog timeout may be set without external components, or adjusted using external capacitors. A windowed watchdog function is used for high reliability applications. The reset input can be used for additional supply monitoring or be configured as a pushbutton reset.

Low operating current ( $20\mu\text{A}$  without load,  $1.5\mu\text{A}$  in shutdown) and low external parts count make the LTC3246 ideally suited for low power, space constrained automotive/industrial applications. The device is short-circuit and overtemperature protected and is available in a thermally enhanced 16-lead MSOP package.

All registered trademarks and trademarks are the property of their respective owners.

## TYPICAL APPLICATION

Regulated 5V Output with Pushbutton Reset

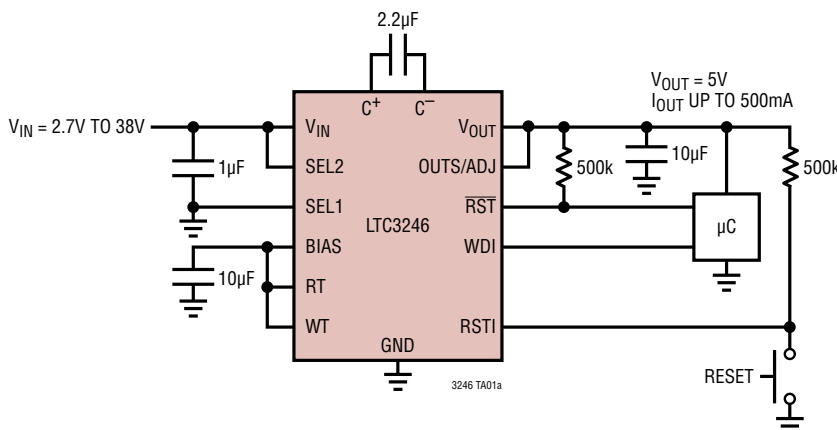

Output Voltage vs Input Voltage

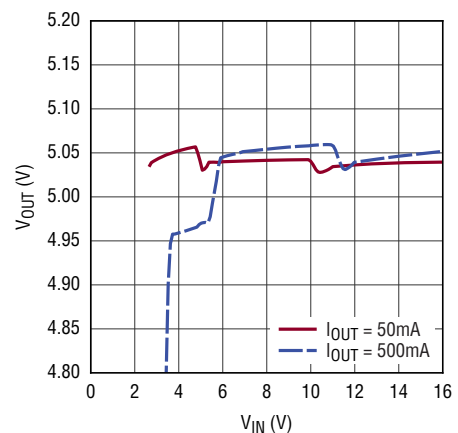

# LTC3246

## ABSOLUTE MAXIMUM RATINGS

(Notes 1, 2)

$V_{IN}$ , SEL1, SEL2, WDI	-0.3V to 42V
$V_{OUT}$ , OUTS/ADJ, RSTI, WT, RT, BIAS, $\overline{RST}$	-0.3V to 6V
$I_{RST}$	10mA
$V_{OUT}$ Short Circuit Duration	Indefinite
Lead Temperature (Soldering, 10 sec)	300°C
Operating Junction Temperature Range (Notes 3, 4)	
(E-Grade/I-Grade)	-40 to 125°C
(H-Grade)	-40 to 150°C
(MP-Grade)	-55 to 150°C
Storage Temperature Range	-65 to 150°C

## PIN CONFIGURATION

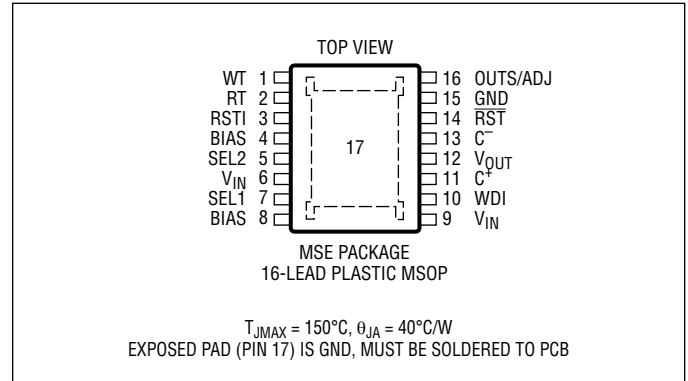

## ORDER INFORMATION <http://www.linear.com/product/LTC3246#orderinfo>

LEAD FREE FINISH	TAPE AND REEL	PART MARKING*	PACKAGE DESCRIPTION	TEMPERATURE RANGE
LTC3246EMSE#PBF	LTC3246EMSE#TRPBF	3246	16-Lead Plastic MSOP	-40°C to 125°C
LTC3246IMSE#PBF	LTC3246IMSE#TRPBF	3246	16-Lead Plastic MSOP	-40°C to 125°C
LTC3246HMSE#PBF	LTC3246HMSE#TRPBF	3246	16-Lead Plastic MSOP	-40°C to 150°C
LTC3246MPMSE#PBF	LTC3246MPMSE#TRPBF	3246	16-Lead Plastic MSOP	-55°C to 150°C

Consult ADI Marketing for parts specified with wider operating temperature ranges. \*The temperature grade is identified by a label on the shipping container. Consult ADI Marketing for information on nonstandard lead based finish parts.

For more information on lead free part marking, go to: <http://www.linear.com/leadfree/>

For more information on tape and reel specifications, go to: <http://www.linear.com/tapeandreeel/>

## ELECTRICAL CHARACTERISTICS

The ● denotes the specifications which apply over the specified operating junction temperature range, otherwise specifications are at  $T_A = 25^\circ\text{C}$ .  $V_{IN} = 12\text{V}$ ,  $C_{FLY} = 2.2\mu\text{F}$ ,  $C_{OUT} = 10\mu\text{F}$ , unless otherwise noted.

SYMBOL	PARAMETER	CONDITIONS	MIN	TYP	MAX	UNITS
$V_{IN}$	Operating Input Voltage Range	(Note 5)	● 2.7		38	V
$V_{UVLO}$	$V_{IN}$ Undervoltage Lockout Threshold			● 2.35	2.7	V
$I_{VIN}$	$V_{IN}$ Quiescent Current Shutdown CP Enabled, Output in Regulation	SEL1 = SEL2 = 0V SEL1 = $V_{IN}$ and/or SEL2 = $V_{IN}$ , RST1 = 5V				
				1.5	3	$\mu\text{A}$
				20	30	$\mu\text{A}$
$V_{HIGH}$	SEL1, SEL2 Input Voltage		●	1.1	1.6	V
$V_{LOW}$	SEL1, SEL2 Input Voltage		● 0.4	0.8		V
$I_{LOW}$	SEL1, SEL2 Input Current	$V_{PIN} = 0\text{V}$	● -1	0	1	$\mu\text{A}$
$I_{HIGH}$	SEL1, SEL2 Input Current	$V_{PIN} = 38\text{V}$	● 0.5	1	2	$\mu\text{A}$

### Charge Pump Operation

$V_{OUTS\_5}$	VOUTS/ADJ Regulation Voltage SEL1 = 0V, SEL2 = $V_{IN}$	2.7V < $V_{IN}$ < 38V (Notes 5, 6)	● 4.8		5.2	V
$V_{OUTS\_3}$	VOUTS/ADJ Regulation Voltage SEL1 = $V_{IN}$ , SEL2 = $V_{IN}$	2.7V < $V_{IN}$ < 38V (Notes 5, 6)	● 3.17		3.43	V
$V_{ADJ}$	VOUTS/ADJ Regulation Voltage SEL1 = $V_{IN}$ , SEL2 = 0V	2.7V < $V_{IN}$ < 38V (Notes 5, 6)	● 1.08	1.11	1.14	V

3246fa

## ELECTRICAL CHARACTERISTICS

The ● denotes the specifications which apply over the specified operating junction temperature range, otherwise specifications are at  $T_A = 25^\circ\text{C}$ .  $V_{IN} = 12\text{V}$ ,  $C_{FLY} = 2.2\mu\text{F}$ ,  $C_{OUT} = 10\mu\text{F}$ , unless otherwise noted.

SYMBOL	PARAMETER	CONDITIONS		MIN	TYP	MAX	UNITS
$I_{ADJ}$	VOULTS/ADJ Input Current SEL1 = SEL2 = $V_{IN}$		●	-50	0	+50	nA
$I_{OUT\_SCKT}$	$I_{V_{OUT}}$ Short Circuit Foldback Current	$V_{OUT} = 0\text{V}$			250		mA
$R_{OUT}$	Charge Pump Output Impedance	2:1 Step-Down Mode 1:1 Step-Down Mode, $V_{IN} = 5.5\text{V}$ 1:2 Step-Up Mode, $V_{IN} = 3\text{V}$ , $V_{OUT} \geq 3.3\text{V}$ (Note 6)	●		1 1.2 4	8	$\Omega$ $\Omega$ $\Omega$
$V_{OUT\_OV\_RST}$	$V_{OUT}$ Overvoltage Reset	% of Final Regulation Voltage at Which $V_{OUT}$ Rising Makes $\overline{RST}$ Go Low $V_{OUT}$ Falling Makes $\overline{RST}$ Go Hi-Z	● ●	106	109 108.5	111.5	% %
$V_{OUT\_UV\_RST}$	$V_{OUT}$ Undervoltage Reset	% of Final Regulation Voltage at Which $V_{OUT}$ Rising Makes $\overline{RST}$ Go Hi-Z $V_{OUT}$ Falling Makes $\overline{RST}$ Go Low	● ●	93	97.5 95	99	% %
$V_{OUT\_PD}$	$V_{OUT}$ Pull-Down in Shut Down	SEL1 = SEL2 = 0V			100		k $\Omega$
$V_{OUT\_RIPPLE}$	$V_{OUT}$ Ripple Voltage	$C_{OUT} = 10\mu\text{F}$ $C_{OUT} = 22\mu\text{F}$			50 25		mV mV

### Reset Timer Control Pin (RT)

$I_{RT(UP)}$	RT Pull-Up Current	$V_{RT} = 0.3\text{V}$	●	-2	-3.1	-4.2	$\mu\text{A}$
$I_{RT(DOWN)}$	RT Pull-Down Current	$V_{RT} = 1.3\text{V}$	●	2	3.1	4.2	$\mu\text{A}$
$I_{RT(INT)}$	Internal RT Detect Current	$V_{RT} = V_{BIAS}$	●		0.4	1	$\mu\text{A}$
$V_{RT(INT)}$	RT Internal Timer Threshold	$V_{RT}$ Rising	●	2.0	2.4	2.65	V

### Reset Timer Input (RSTI)

$V_{RSTI\_H}$	RSTI Input High Voltage		●		1.22	1.27	V
$V_{RSTI\_L}$	RSTI Input Low Voltage		●	1.04	1.2		V
$I_{RSTI\_H}$	RSTI Input High Current	RSTI = 5V	●	-1	0	1	$\mu\text{A}$
$I_{RSTI\_L}$	RSTI Input Low Current	RSTI = 0V	●	-1	0	1	$\mu\text{A}$

### Reset Timing

$t_{RST(INT)}$	Internal Reset Timeout Period	$V_{RT} = V_{BIAS}$		150	200	270	ms
$t_{RST(EXT)}$	Adjustable Reset Timeout Period	$C_{RT} = 2.2\text{nF}$	●	14	21	28	ms
$t_{RSTIL}$	RSTI Low to $\overline{RST}$ Asserted		●	5	20	40	$\mu\text{s}$

### Reset Output (RST)

$V_{OL(RST)}$	Output Voltage Low $\overline{RST}$	$I_{RST} = 2\text{mA}$	●		0.1	0.4	V
$I_{OH(RST)}$	$\overline{RST}$ Output Voltage High Leakage	$V_{\overline{RST}} = 5\text{V}$	●	-1	0	1	$\mu\text{A}$

### Watchdog Timing

$t_{WDR(INT)}$	Internal Watchdog Upper Boundary	$V_{WT} = V_{BIAS}$	●	1.2	1.6	2.2	s
$t_{WDL(INT)}$	Internal Watchdog Lower Boundary	$V_{WT} = V_{BIAS}$	●	37.5	50	68	ms
$t_{WDR(EXT)}$	External Watchdog Timeout Period	$C_{WT} = 2.2\text{nF}$	●	100	160	220	ms
$t_{WDR(EXT)}$	External Watchdog Upper Boundary		●		$t_{WDR(EXT)} \cdot (128/129)$		ms
$t_{WDL(EXT)}$	External Watchdog Lower Boundary		●		$t_{WDR(EXT)} \cdot (5/129)$		ms

### Watchdog Timer Input (WDI)

$V_{IH}$	WDI Input High Voltage		●		1.1	1.6	V
$V_{OL}$	WDI Input Low Voltage		●	0.4	0.8		V
$I_{IH}$	WDI Input High Current	$V_{WDI} = 38\text{V}$	●	-1	0	1	$\mu\text{A}$
$I_{IL}$	WDI Input Low Current	$V_{WDI} = 0\text{V}$	●	-1	0	1	$\mu\text{A}$
$t_{PW(WDI)}$	Input Pulsewidth		●	400			ns

## ELECTRICAL CHARACTERISTICS

The ● denotes the specifications which apply over the specified operating junction temperature range, otherwise specifications are at  $T_A = 25^\circ\text{C}$ .  $V_{IN} = 12\text{V}$ ,  $C_{FLY} = 2.2\mu\text{F}$ ,  $C_{OUT} = 10\mu\text{F}$ , unless otherwise noted.

SYMBOL	PARAMETER	CONDITIONS	MIN	TYP	MAX	UNITS
<b>Watchdog Timer Control Pin (WT)</b>						
$I_{WT(UP)}$	WT Pull-Up Current	$V_{WT} = 0.3\text{V}$	● -2	-3.1	-4.2	$\mu\text{A}$
$I_{WT(DOWN)}$	WT Pull-Down Current	$V_{WT} = 1.3\text{V}$	● 2	3.1	4.2	$\mu\text{A}$
$I_{WT(INT)}$	Internal WT Detect Current	$V_{WT} = V_{BIAS}$	●	0.4	1	$\mu\text{A}$
$V_{WT(INT)}$	WT Internal Timer Threshold	$V_{WT}$ Rising	● 2	2.2	2.65	V

**Note 1:** Stresses beyond those listed under Absolute Maximum Ratings may cause permanent damage to the device. Exposure to any Absolute Maximum Rating condition for extended periods may affect device reliability and lifetime.

**Note 2:** All voltages are referenced to GND unless otherwise specified.

**Note 3:** The LTC3246E is guaranteed to meet performance specifications from  $0^\circ\text{C}$  to  $85^\circ\text{C}$  operating junction temperature. Specifications over the  $-40^\circ\text{C}$  to  $125^\circ\text{C}$  operating junction temperature range are assured by design, characterization and correlation with statistical process controls. The LTC3246I is guaranteed over the  $-40^\circ\text{C}$  to  $125^\circ\text{C}$  operating junction temperature range. The LTC3246H is guaranteed over the  $-40^\circ\text{C}$  to  $150^\circ\text{C}$  operating junction temperature range. The LTC3246MP is guaranteed and tested over the  $-55^\circ\text{C}$  to  $150^\circ\text{C}$  operating junction temperature range. High junction temperatures degrade operating lifetimes; operating lifetime is derated for junction temperatures greater than  $125^\circ\text{C}$ . Note that the maximum ambient temperature consistent with these specifications is determined by specific operating conditions in conjunction with board layout, the rated package thermal resistance and other environmental factors.

The junction temperature ( $T_J$ , in  $^\circ\text{C}$ ) is calculated from the ambient temperature ( $T_A$ , in  $^\circ\text{C}$ ) and power dissipation ( $P_D$ , in watts) according to the formula:

$$T_J = T_A + (P_D \cdot \theta_{JA}), \text{ where } \theta_{JA} \text{ (in } ^\circ\text{C/W) is the package thermal impedance.}$$

**Note 4:** This IC has overtemperature protection that is intended to protect the device during momentary overload conditions. Junction temperatures will exceed  $150^\circ\text{C}$  when overtemperature protection is active. Continuous operation above the specified maximum operating junction temperature may impair device reliability.

**Note 5:** The maximum operating junction temperature of  $150^\circ\text{C}$  must be followed. Certain combinations of input voltage, output current and ambient temperature will cause the junction temperature to exceed  $150^\circ\text{C}$  and must be avoided. See Thermal Management section for information on calculating maximum operating conditions.

**Note 6:** The LTC3246 will attempt to regulate the output voltage under all load conditions, but like any regulator, the output will drop out if inadequate supply voltage exists for the load. See  $V_{OUT}$  Regulation section for calculating available load current at low input operating voltages. Also see "Boost Output Impedance at Dropout vs Temperature" for typical impedance values at output voltages less than  $3.3\text{V}$ .

## TYPICAL PERFORMANCE CHARACTERISTICS

$T_A = 25^\circ\text{C}$ , unless otherwise noted.

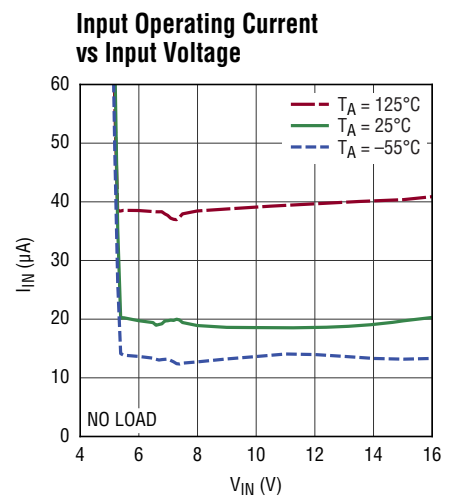
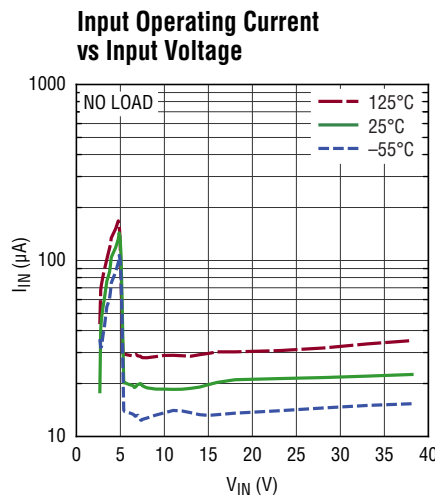
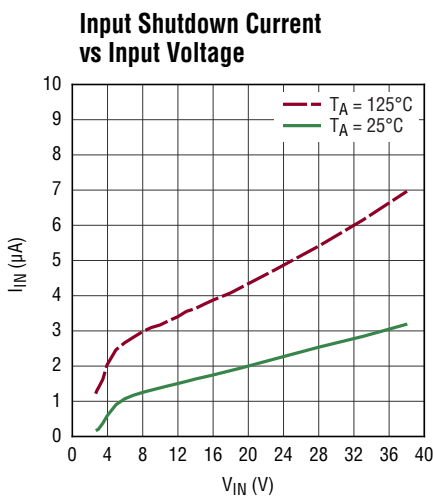

**TYPICAL PERFORMANCE CHARACTERISTICS**  $T_A = 25^\circ\text{C}$ , unless otherwise noted.

**3.3V Fixed Output Voltage vs Input Voltage**

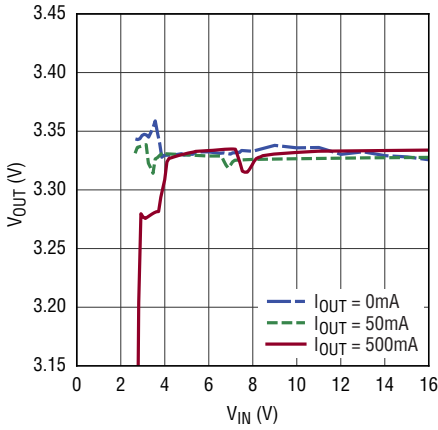

3246 G04

**3.3V Fixed Output Voltage vs Input Voltage**

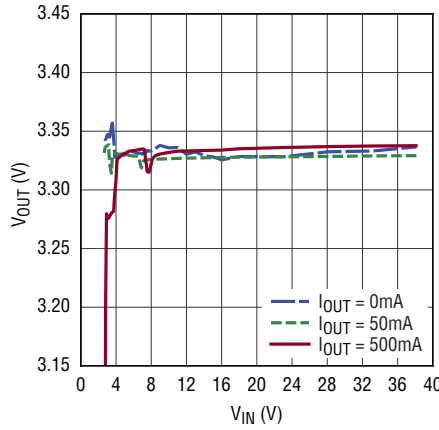

3246 G05

**3.3V Efficiency and Power Loss vs Input Voltage**

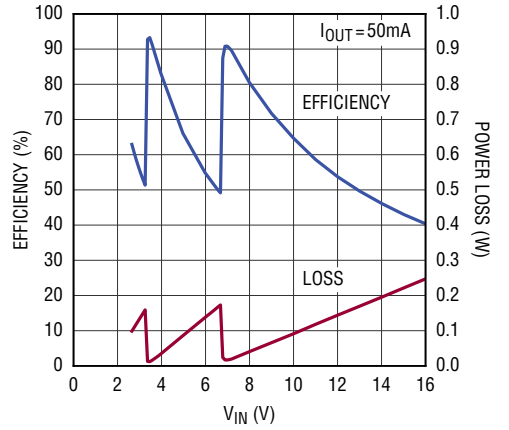

3246 G06

**5V Fixed Output Voltage vs Input Voltage**

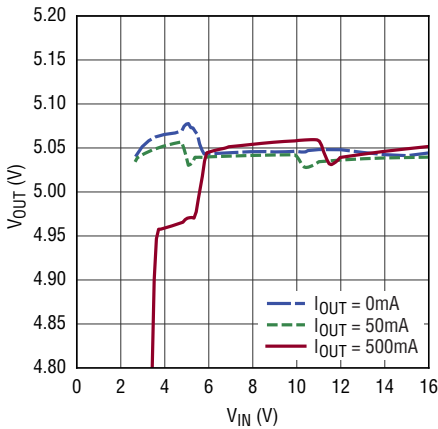

3246 G07

**5V Fixed Output Voltage vs Input Voltage**

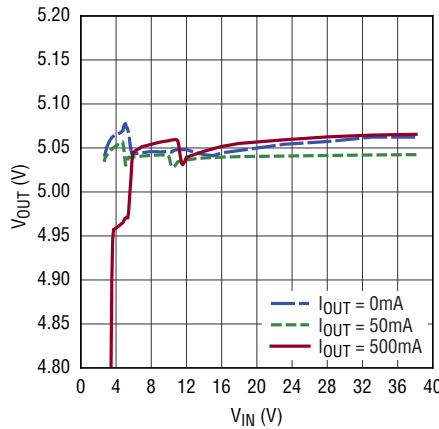

3246 G08

**5V Efficiency and Power Loss vs Input Voltage**

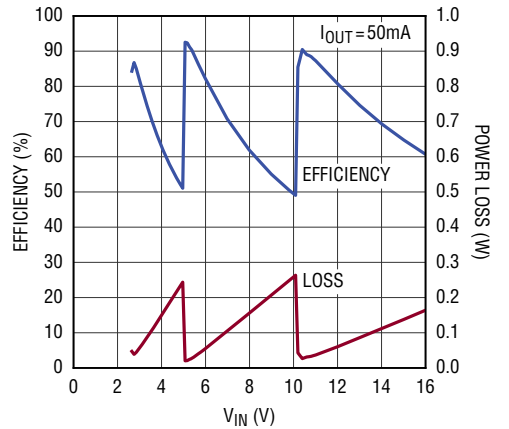

3246 G09

**5V Efficiency and Power Loss vs Input Voltage**

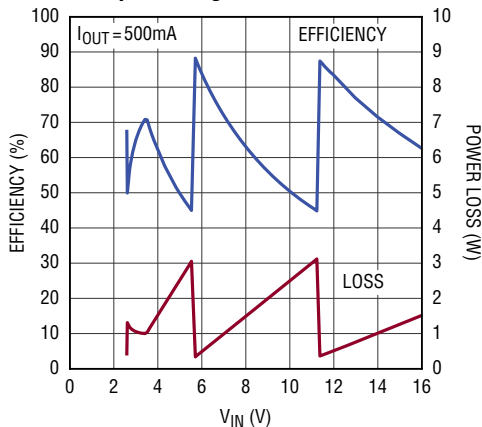

3246 G10

**3.3V Efficiency and Power Loss vs Input Voltage**

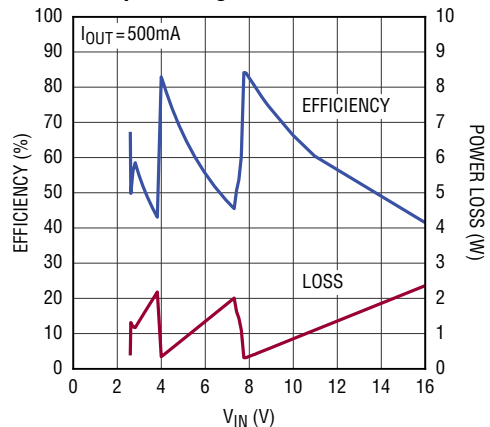

3246 G11

## TYPICAL PERFORMANCE CHARACTERISTICS $T_A = 25^\circ\text{C}$ , unless otherwise noted.

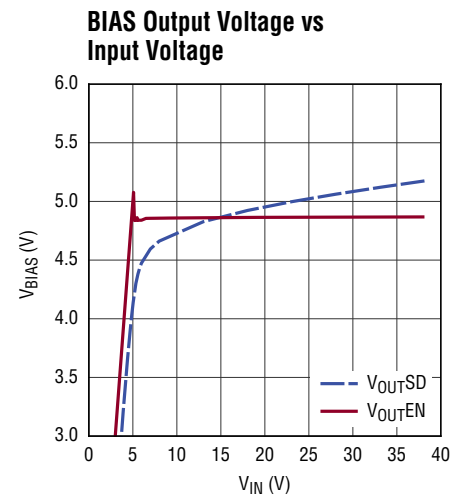
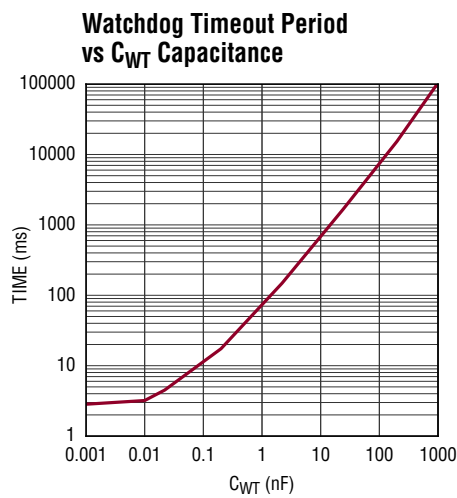
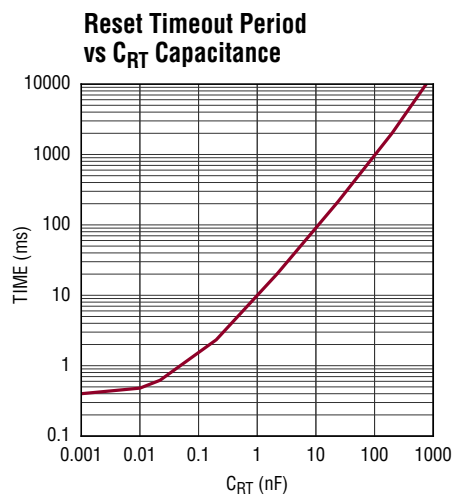
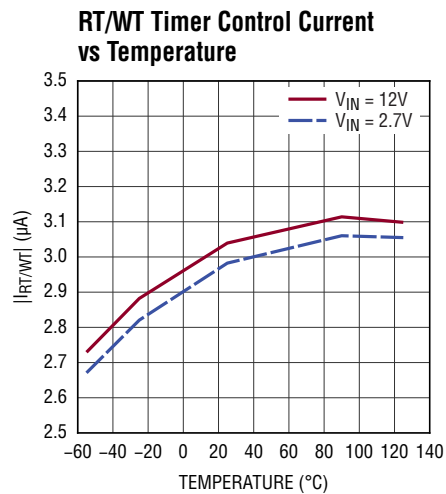
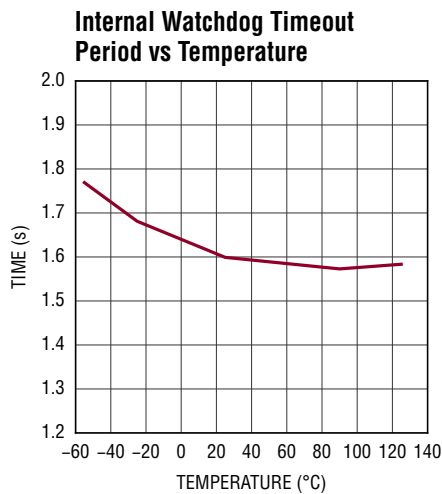
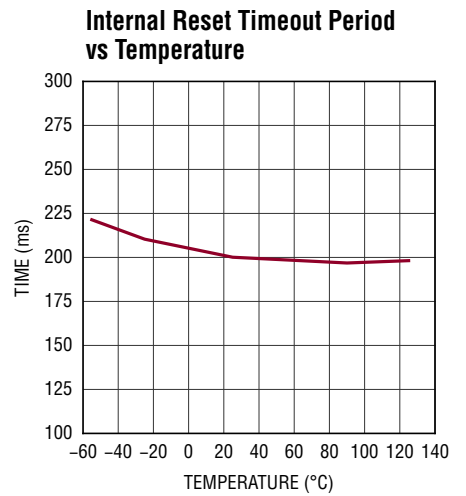
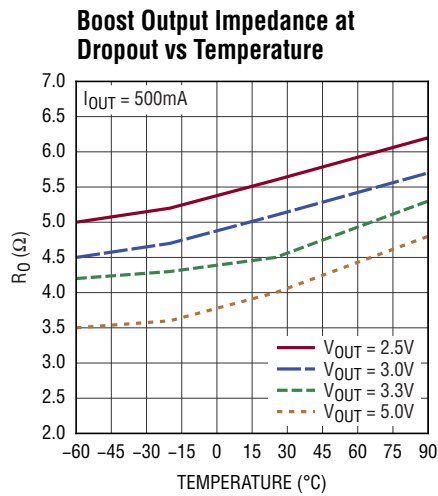
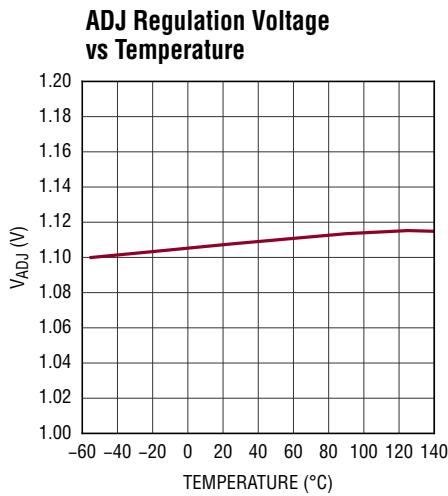

**TYPICAL PERFORMANCE CHARACTERISTICS**  $T_A = 25^\circ\text{C}$ , unless otherwise noted.

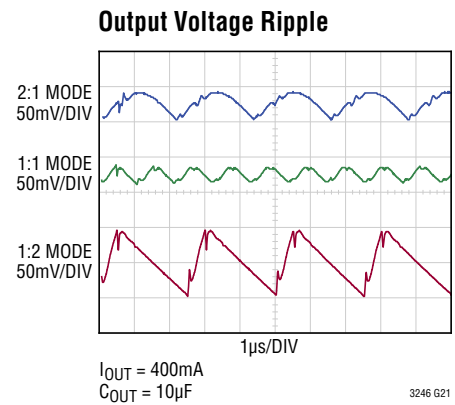
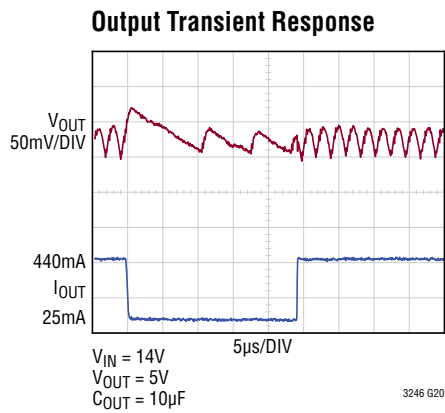

**TIMING DIAGRAMS**

**Charge Pump Output Reset Timing**

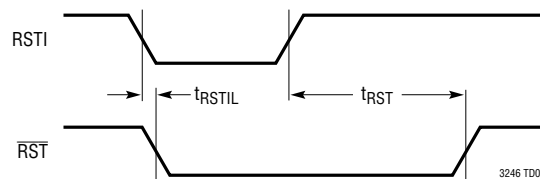

**Watchdog Timing**

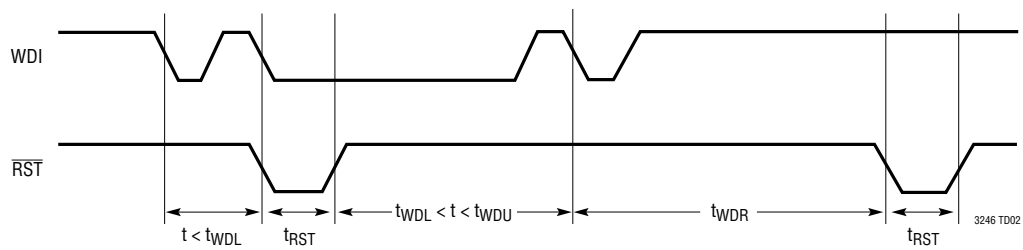



## PIN FUNCTIONS

**WT (Pin 1):** Watchdog Timer Control Pin. Attach an external capacitor ( $C_{WT}$ ) to GND to set a watchdog upper boundary timeout time (See “Watchdog Timeout Period vs WT Capacitance” graph on page 6). Tie WT to BIAS to generate a timeout of about 1.6s. Tie WT and WDI to GND to disable the watchdog timer.

**RT (Pin 2):** Reset Timeout Control Pin. Attach an external capacitor ( $C_{RT}$ ) to GND to set a reset timeout time (See “Reset Timeout Period vs RT Capacitance” graph on page 6). Tie RT to BIAS to generate a reset timeout of about 200ms.

**RSTI (Pin 3):** Reset Logic Comparator Pin. The RSTI input is compared to a reference threshold (1.2V typical). If RSTI is below the reference voltage, the part will enter the reset state and the  $\overline{RST}$  pin will be low. Once RSTI exceeds the reference voltage and  $V_{OUT}$  in regulation, the reset timer is started.  $\overline{RST}$  pin will be low until the reset period times out. RSTI is a high impedance pin and must be driven to a valid level. Do not float.

**BIAS (Pin 4, 8):** Internal BIAS Voltage. The bias pin is for internal operation only and should not be loaded or driven externally. Bypass BIAS with a 10 $\mu$ F or greater ceramic capacitor.

**SEL2 (Pin 5):** Logic Input Pin. See Table 1 for SEL1/SEL2 operating logic. SEL2 enables and disables the charge pump along with the SEL1 pin. The SEL2 pin has a 1 $\mu$ A (typical) pull down current to ground and can tolerate 38V inputs allowing it to be pin-strapped to  $V_{IN}$ .

**$V_{IN}$  (Pin 6, 9):** Power Input Pin. Input voltage for both charge pump and IC control circuitry. The  $V_{IN}$  pin operates from 2.7V to 38V. All  $V_{IN}$  pins should be connected together at pins and bypassed with a 1 $\mu$ F or greater ceramic capacitor.

**SEL1 (Pin 7):** Logic Input Pin. See Table 1 for SEL1/SEL2 operating logic. SEL1 enables and disables the charge pump along with the SEL2 pin. The SEL1 pin has a 1 $\mu$ A (typical) pull down current to ground and can tolerate 38V inputs allowing it to be pin-strapped to  $V_{IN}$ .

**Table 1.  $V_{OUT}$  Operating Modes**

SEL2	SEL1	MODE
LOW	LOW	Shutdown
LOW	HIGH	Adjustable $V_{OUT}$
HIGH	LOW	Fixed 5V
HIGH	HIGH	Fixed 3.3V

**WDI (Pin 10):** Watchdog Logic Input Pin. If the watchdog timer is not disabled then WDI must be driven such that a falling edge occurs within a time less than the watchdog upper boundary time, or  $\overline{RST}$  will be asserted low. The WDI period must also be greater than the watchdog lower boundary time, and only falling edges are considered. Tie WT and WDI to GND to disable the watchdog timer. WDI is a high impedance pin and must be driven to a valid level. Do not float.

**C+ (Pin 11):** Connect to positive flying capacitor terminal only. Do not load or drive externally.

**$V_{OUT}$  (Pin 12):** Charge Pump Output Voltage. The charge pump output is enabled if either SEL1 or SEL2 are logic high.

**C- (Pin 13):** Connect to negative flying capacitor terminal only. Do not load or drive externally.

**$\overline{RST}$  (Pin 14):** Reset Open Drain Logic Output. The  $\overline{RST}$  pin is low impedance during the reset period, and goes high impedance during the watchdog period.  $\overline{RST}$  is intended to be pulled up to low voltage supply (such as  $V_{OUT}$ ) with an external resistor.

**GND (Pin 15, Exposed Pad):** Ground. The exposed package pad is ground and must be soldered to the PC board ground plane for proper functionality and for rated thermal performance.

**OUTS/ADJ (Pin 16):**  $V_{OUT}$  Sense/Adjust Input Pin. This pin acts as  $V_{OUT}$  sense (OUTS) for 5V or 3.3V fixed outputs and adjust (ADJ) for adjustable output through external feedback. The ADJ pin servos to 1.1V when the device is enabled in adjustable mode. (OUTS/ADJ are selected by SEL1 and SEL2 pins; See Table 1). Connect OUTS/ADJ to  $V_{OUT}$  or external divider as appropriate.

# SIMPLIFIED BLOCK DIAGRAM

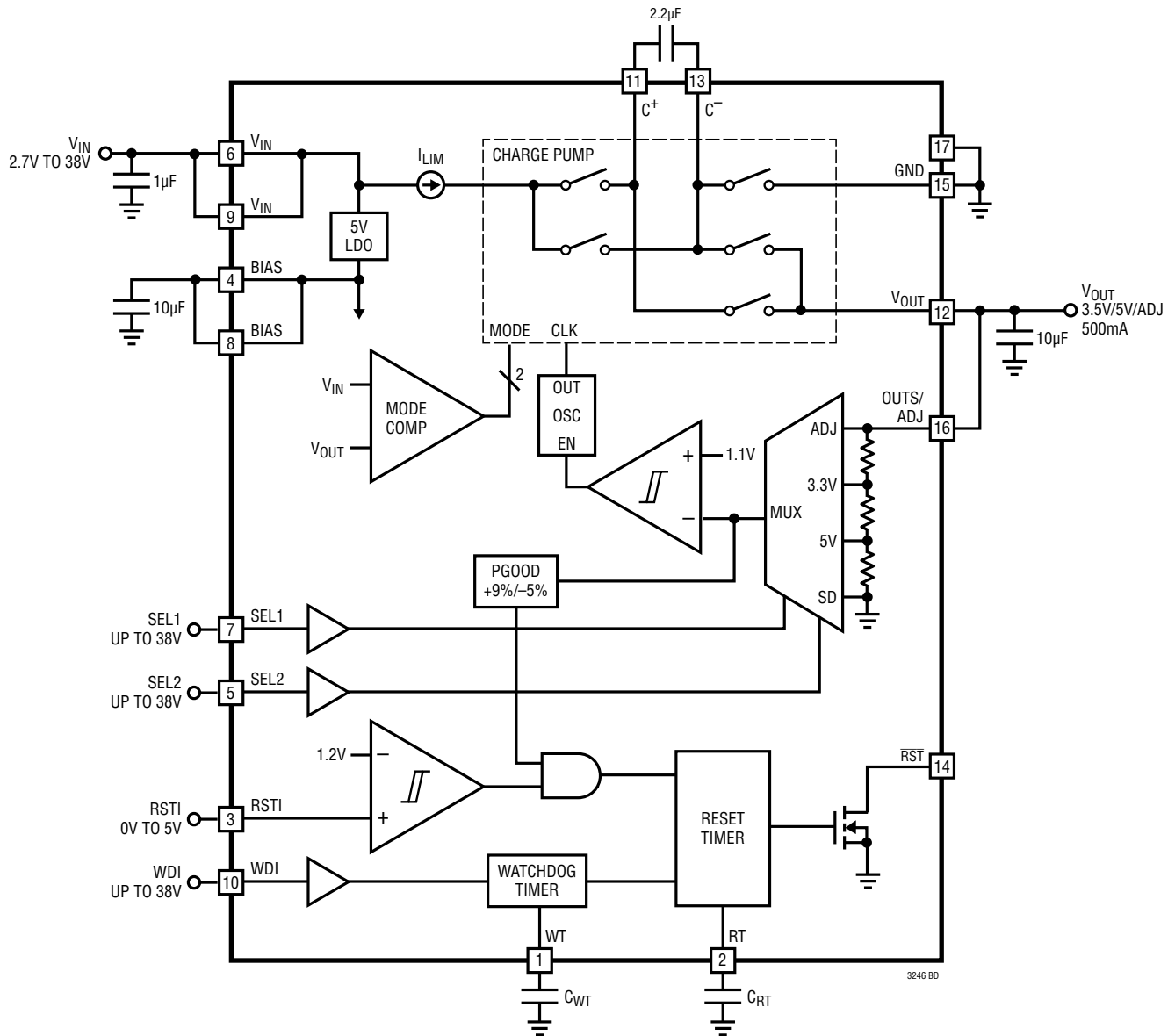

## APPLICATIONS INFORMATION

### General Operation

The LTC3246 uses switched capacitor based DC/DC conversion to provide the efficiency advantages associated with inductor based circuits as well as the cost and simplicity advantages of a linear regulator. The LTC3246 uses an internal switch network and fractional conversion ratios to achieve high efficiency and regulation over widely varying  $V_{IN}$  and output load conditions.

Internal control circuitry selects the appropriate conversion ratio based on  $V_{IN}$  and load conditions. The device has three possible conversion modes: 2:1 step-down mode, 1:1 step-down mode and 1:2 step-up mode. Only one external flying capacitor is needed to operate in all three modes. 2:1 mode is chosen when  $V_{IN}$  is greater than two times the desired  $V_{OUT}$ . 1:1 mode is chosen when  $V_{IN}$  falls between two times  $V_{OUT}$  and  $V_{OUT}$ . 1:2 mode is chosen when  $V_{IN}$  falls below the desired  $V_{OUT}$ . The internal mode control logic maintains output regulation over all load conditions.

Regulation is achieved by sensing the output voltage and enabling charge transfer when the output falls below regulation. When the charge pump is enabled, it controls the current into the flying capacitor to limit the output ripple beyond that of conventional switched capacitor charge pumps. The part has two SEL pins that select the output regulation (fixed 5V, fixed 3.3V or adjustable) as well as shutdown.

The charge pump operates at a nominal frequency of about 450kHz, though actual output ripple frequency will vary with output load, operating mode and output capacitance.

The LTC3246 is designed for applications requiring high system reliability. The part includes output supply monitoring and watchdog timing circuitry as well as overvoltage, short-circuit and overtemperature protection.

### $V_{OUT}$ Regulation and Mode Selection

Regulation is achieved by sensing the output voltage and enabling charge transfer when the output falls below the programmed regulation voltage. The amount of charge transferred per cycle is controlled over the full input range to minimize output ripple. The regulation voltage (fixed 5V, fixed 3.3V or adjustable) is selected through the SEL1 and SEL2 pins per Table 1 in the Pin Function section.

The optimal conversion ratio is chosen based on  $V_{IN}$ ,  $V_{OUT}$  and output conditions. Two internal comparators are used to select the default conversion ratio. The conversion ratio switch point is optimized to provide peak efficiency over all supply and load conditions while maintaining regulation. Each comparator also has built-in hysteresis to reduce the tendency of oscillating between modes when a transition point is reached.

The LTC3246 will attempt to regulate its output over the full operating range (2.7V to 38V), but like any regulator the output will drop out of regulation if inadequate supply voltage exists to the operating load. As the input voltage drops, the LTC3246 will eventually end up in the 1:2 step up mode. As the input voltage drops further, the output will eventually drop out of regulation. At this point, the 1:2 step-up charge pump impedance can be calculated as:

$$R_{OUT} = \frac{2 \cdot V_{IN} - V_{OUT}}{I_{OUT}}$$

This equation can be rewritten to determine the output current at which the output will drop out for a given input voltage as:

$$I_{OUT} = \frac{2 \cdot V_{IN} - V_{OUT}}{R_{OUT}} \quad (I_{OUT} \leq 500\text{mA})$$

For a typical 1:2 step-up charge pump impedance of  $4\Omega$  with 5V output voltage and 3V input voltage, the output current at dropout will be about:

$$I_{OUT} = \frac{2 \cdot 3 - 4.8}{4} \text{mA} = 300\text{mA}$$

Thus, typically the part should be able to output 300mA without dropping out. To be conservative, the max 1:2 step-up charge pump impedance of  $8\Omega$  should be used which gives a more conservative output current of 150mA.

Any supply impedance in series with the LTC3246 must be doubled and added to the 1:2 step-up charge pump impedance. It is also important to have the specified  $C_{OUT}$  and  $C_{FLY}$  capacitance to achieve the specified output impedance. Observing dropout will allow the user to calculate the output impedance for their specific application.

## APPLICATIONS INFORMATION

### Short-Circuit/Thermal Protection

The LTC3246 has built-in short-circuit current limiting on both the  $V_{OUT}$  and BIAS outputs to protect the part in the event of a short. During short-circuit conditions, the device will automatically limit the output current from both outputs.

The LTC3246 has thermal protection that will shut down the device if the junction temperature exceeds the overtemperature threshold (typically 175°C). Thermal shutdown is included to protect the IC in cases of excessively high ambient temperatures, or in cases of excessive power dissipation inside the IC. The charge transfer will reactivate once the junction temperature drops back to approximately 165°C.

When the thermal protection is active, the junction temperature is beyond the specified operating range. The thermal and short-circuit protection are intended for momentary overload conditions outside normal operation. Continuous operation above the specified maximum operating conditions may impair device reliability.

### Programming the Output Voltage (OUTS/ADJ Pin)

The LTC3246 output voltage programming is very flexible offering a fixed 3.3V output, fixed 5V output as well as adjustable output that is programmed through an external resistor divider. The desired output regulation method is selected through the SEL pins.

For a fixed output simply short OUTS (OUTS/ADJ pin) to  $V_{OUT}$  as shown in Figure 1. Fixed 3.3V operation is enabled by driving both SEL1 and SEL2 pins high, while fixed 5V operating is selected by driving SEL2 high with SEL1 low. Driving both SEL1 and SEL2 low shuts down the device causing  $V_{OUT}$  to be pulled low by an internal impedance of about 80kΩ.

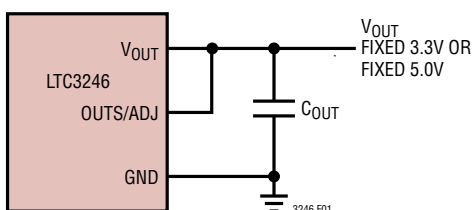

Figure 1. Fixed Output Operation

Adjustable output programming is accomplished by connecting ADJ (OUTS/ADJ pin) to a resistor divider between  $V_{OUT}$  and GND as shown in Figure 2. Adjustable operation is enabled by driving SEL1 high and SEL2 low. Driving both SEL1 and SEL2 low shuts down the device, causing  $V_{OUT}$  to be pulled low by an internal impedance of about 80kΩ.

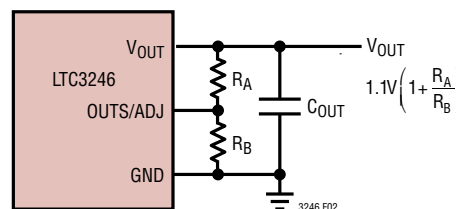

Figure 2. Adjustable Output Operation

Using adjustable operation, the output ( $V_{OUT}$ ) can be programmed to regulate from 2.5V to 5V. The limited programming range provides the required  $V_{OUT}$  operating voltage without overstressing the  $V_{OUT}$  pin.

The desired adjustable output voltage is programmed by solving the following equation for  $R_A$  and  $R_B$ :

$$\frac{R_A}{R_B} = \frac{V_{OUT}}{1.11V} - 1$$

Select a value for  $R_B$  in the range of 1k to 1M and solve for  $R_A$ . Note that the resistor divider current adds to the total no load operating current. Thus, a larger value for  $R_B$  will result in lower operating current.

### 2:1 Step-Down Charge Pump Operation

When the input supply is greater than about two times the output voltage, the LTC3246 will operate in 2:1 step-down mode. Charge transfer happens in two phases. On the first phase, the flying capacitor ( $C_{FLY}$ ) is connected between  $V_{IN}$  and  $V_{OUT}$ . On this phase,  $C_{FLY}$  is charged up and current is delivered to  $V_{OUT}$ . On the second phase, the flying capacitor ( $C_{FLY}$ ) is connected between  $V_{OUT}$  and GND. The charge stored on  $C_{FLY}$  during the first phase is transferred to  $V_{OUT}$  on the second phase. When in 2:1 step-down mode, the input current will be approximately

## APPLICATIONS INFORMATION

half of the total output current. The efficiency ( $\eta$ ) and chip power dissipation ( $P_D$ ) in 2:1 are approximately:

$$\eta \cong \frac{P_{OUT}}{P_{IN}} = \frac{V_{OUT} \cdot I_{OUT}}{V_{IN} \cdot \frac{1}{2} I_{OUT}} = \frac{2V_{OUT}}{V_{IN}}$$

$$P_D = \left( \frac{V_{IN}}{2} - V_{OUT} \right) I_{OUT}$$

### 1:1 Step-Down Charge Pump Operation

When the input supply is less than about two times the output voltage, but more than the programmed output voltage, the LTC3246 will operate in 1:1 step-down mode. This method of regulation is very similar to a linear regulator. Charge is delivered directly from  $V_{IN}$  to  $V_{OUT}$  through most of the oscillator period. The charge transfer is briefly interrupted at the end of the period. When in 1:1 step-down mode, the input current will be approximately equal to the total output current. Thus, efficiency ( $\eta$ ) and chip power dissipation ( $P_D$ ) in 1:1 are approximately:

$$\eta \cong \frac{P_{OUT}}{P_{IN}} = \frac{V_{OUT} \cdot I_{OUT}}{V_{IN} \cdot I_{OUT}} = \frac{V_{OUT}}{V_{IN}}$$

$$P_D = (V_{IN} - V_{OUT}) I_{OUT}$$

### 1:2 Step-Up Charge Pump Operation

When the input supply is less than the output voltage, the LTC3246 will operate in 1:2 step-up mode. Charge transfer happens in two phases. On the first phase, the flying capacitor ( $C_{FLY}$ ) is connected between  $V_{IN}$  and GND. On this phase,  $C_{FLY}$  is charged up. On the second phase, the flying capacitor ( $C_{FLY}$ ) is connected between  $V_{IN}$  and  $V_{OUT}$  and the charge stored on  $C_{FLY}$  during the first phase is transferred to  $V_{OUT}$ . When in 1:2 step-up mode, the input current will be approximately twice the total output current. Thus, efficiency ( $\eta$ ) and chip power dissipation ( $P_D$ ) in 1:2 are approximately:

$$\eta \cong \frac{P_{OUT}}{P_{IN}} = \frac{V_{OUT} \cdot I_{OUT}}{V_{IN} \cdot 2I_{OUT}} = \frac{V_{OUT}}{2V_{IN}}$$

$$P_D = (2V_{IN} - V_{OUT}) I_{OUT}$$

### $V_{OUT}$ Ripple and Capacitor Selection

The type and value of capacitors used with the LTC3246 determine output ripple and charge pump strength. The value of  $C_{OUT}$  directly controls the amount of output ripple for a given load current. Output ripple decreases with output capacitance until about 20 $\mu$ F, at which point output peak to peak ripple remains more or less constant. See Figure 3 for graph of output ripple vs output capacitance.

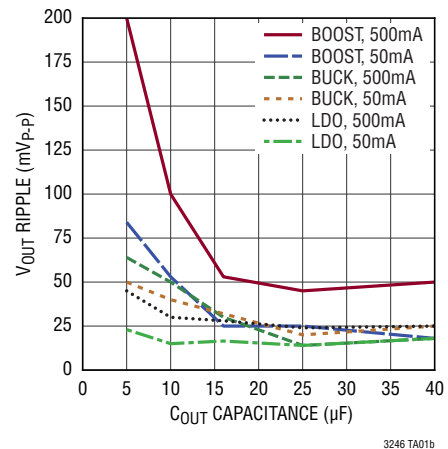

Figure 3. Typical  $V_{OUT}$  Ripple Voltage vs  $C_{OUT}$  Capacitance

To reduce output noise and ripple, it is suggested that a low ESR (equivalent series resistance  $< 0.1\Omega$ ) ceramic capacitor (10 $\mu$ F or greater) be used for  $C_{OUT}$ . For optimal performance, it is best to increase  $C_{OUT}$  for low  $V_{OUT}$  as the ripple becomes a larger percentage of the regulation voltage degrading performance. Tantalum and aluminum capacitors can be used in parallel with a ceramic capacitor to increase the total capacitance but are not recommended to be used alone because of their high ESR.

### $V_{OUT}$ Overvoltage Protection

An internal comparator monitors the voltage at  $V_{OUT}$  and will prevent charge transfer in the event that  $V_{OUT}$  exceeds the overvoltage threshold (5.9V typ.). Overvoltage protection is added as a safety feature to prevent damage to the part in the event of a fault such as  $V_{OUTS}/ADJ$  pin shorted to ground or not connected to  $V_{OUT}$ . Charge transfer will start once the output falls to about 5.75V.

## APPLICATIONS INFORMATION

### $V_{IN}$ Capacitor Selection

The finite charge transfer architecture used by the LTC3246 makes input noise filtering much less demanding than the sharp current spikes of conventional regulated charge pumps. Depending on the mode of operation, the input current of the LTC3246 can step from about 1A to 0A on a cycle-by-cycle basis. Low ESR will reduce the voltage steps caused by changing input current, while the absolute capacitor value will determine the level of ripple. The total amount and type of capacitance necessary for input bypassing is very dependent on the applied source impedance as well as existing bypassing already on the  $V_{IN}$  node. For optimal input noise and ripple reduction, it is recommended that a low ESR ceramic capacitor be used for  $C_{IN}$  bypassing. An electrolytic or tantalum capacitor may be used in parallel with the ceramic capacitor on  $C_{IN}$  to increase the total capacitance, but, due to the higher ESR, it is not recommended that an electrolytic or tantalum capacitor be used alone for input bypassing. The LTC3246 will operate with capacitors less than 1 $\mu$ F, but, depending on the source impedance, input noise can feed through to the output causing degraded performance. For best performance 1 $\mu$ F or greater total capacitance is suggested for  $C_{IN}$ .

### Flying Capacitor Selection

Ceramic capacitors should always be used for the flying capacitor. The flying capacitor controls the strength of the charge pump. In order to achieve the rated output current, it is necessary for the flying capacitor to have at least 1 $\mu$ F of capacitance over operating temperature with a bias voltage equal to the programmed  $V_{OUT}$  (see Ceramic Capacitor Selection Guidelines). If only 100mA or less of output current is required for the application, the flying capacitor minimum can be reduced to 0.2 $\mu$ F. The voltage rating of the ceramic capacitor should be  $V_{OUT} + 1V$  or greater.

### Ceramic Capacitor Selection Guidelines

Capacitors of different materials lose their capacitance with higher temperature and voltage at different rates. For example, a ceramic capacitor made of X5R or X7R

material will retain most of its capacitance from  $-40^{\circ}C$  to  $85^{\circ}C$ , whereas a Z5U or Y5V style capacitor will lose considerable capacitance over that range (60% to 80% loss typical). Z5U and Y5V capacitors may also have a very strong voltage coefficient, causing them to lose an additional 60% or more of their capacitance when the rated voltage is applied. Therefore, when comparing different capacitors, it is often more appropriate to compare the amount of achievable capacitance for a given case size rather than discussing the specified capacitance value. For example, over rated voltage and temperature conditions, a 4.7 $\mu$ F, 10V, Y5V ceramic capacitor in an 0805 case may not provide any more capacitance than a 1 $\mu$ F, 10V, X5R or X7R available in the same 0805 case. In fact, over bias and temperature range, the 1 $\mu$ F, 10V, X5R or X7R will provide more capacitance than the 4.7 $\mu$ F, 10V, Y5V. The capacitor manufacturer's data sheet should be consulted to determine what value of capacitor is needed to ensure minimum capacitance values are met over operating temperature and bias voltage. Below is a list of ceramic capacitor manufacturers and how to contact them:

MANUFACTURER	WEBSITE
AVX	<a href="http://www.avxcorp.com">www.avxcorp.com</a>
Kemet	<a href="http://www.kemet.com">www.kemet.com</a>
Murata	<a href="http://www.murata">www.murata</a>
Taiyo Yuden	<a href="http://www.t-yuden.com">www.t-yuden.com</a>
TDK	<a href="http://www.tdk.com">www.tdk.com</a>
Würth Elektronik	<a href="http://www.we-online.com">www.we-online.com</a>

### BIAS Pin and Capacitor Selection

The BIAS pin of the LTC3246 is a 5V output that is generated by an internal Low Drop-Out (LDO) regulator supplied by  $V_{IN}$ . The BIAS voltage is used as a supply for the internal low voltage circuitry. A capacitor on the BIAS pin is necessary to stabilize the LDO output and minimize ripple during transient conditions. A low ESR ceramic capacitor with a minimum capacitance of 2 $\mu$ F over temperature with 5V bias should be used. Since the BIAS voltage comes from an LDO, the BIAS voltage will drop with  $V_{IN}$  as  $V_{IN}$  goes below 5V. This is normal and expected operation. The BIAS pin voltage is for internal circuitry only and should not be loaded externally.

## APPLICATIONS INFORMATION

### Reset Generation (RSTI input, $\overline{\text{RST}}$ output)

The LTC3246 pulls the  $\overline{\text{RST}}$  open-drain output low whenever RSTI is below threshold (typically 1.2V) or  $V_{\text{OUT}}$  is greater than the overvoltage threshold or less than the undervoltage threshold.  $\overline{\text{RST}}$  remains asserted low for a reset timeout period ( $t_{\text{RST}}$ ) once RSTI goes above the threshold and  $V_{\text{OUT}}$  is in regulation (within the overvoltage and undervoltage thresholds).  $\overline{\text{RST}}$  de-asserts by going high impedance at the end of the reset timeout period.

The reset timeout can be configured to use an internal timer without external components or an adjustable timer programmed by connecting an external capacitor from the RT pin to GND. Glitch filtering ensures reliable reset operation without false triggering.

During initial power up, the  $\overline{\text{RST}}$  output asserts low while  $V_{\text{IN}}$  is below the  $V_{\text{IN}}$  undervoltage lockout threshold. The state of  $V_{\text{OUT}}$  and RSTI have no effect on  $\overline{\text{RST}}$  while  $V_{\text{IN}}$  is below the undervoltage lockout threshold. The reset timeout period cannot start until  $V_{\text{IN}}$  exceeds the undervoltage lockout threshold.

### $V_{\text{OUT}}$ Undervoltage/Overvoltage Reset

A built-in  $V_{\text{OUT}}$  supply monitor ensures the  $V_{\text{OUT}}$  is in regulation before  $\overline{\text{RST}}$  is allowed to go high impedance. The monitor detects both overvoltage and undervoltage faults.

If  $V_{\text{OUT}}$  is greater than the overvoltage threshold or less than the undervoltage threshold, the part registers a fault and pulls  $\overline{\text{RST}}$  low. The fault condition is removed when  $V_{\text{OUT}}$  is within the overvoltage and undervoltage thresholds.

Load transients within the operating range of the part will not register as a fault by design.

### Selecting the Reset Timing Capacitor

The reset timeout period can be set to a fixed internal timer or programmed with a capacitor in order to accommodate a variety of applications. Connecting a capacitor,  $C_{\text{RT}}$ , between the RT pin and GND sets the reset timeout period,  $t_{\text{RST}}$ .

Figure 4 shows the desired reset timeout period as a function of the value of the timer capacitor. Leaving RT

open without external capacitor generates a reset timeout of approximately 0.5ms. Shorting RT to BIAS generates a reset timeout of approximately 0.2s.

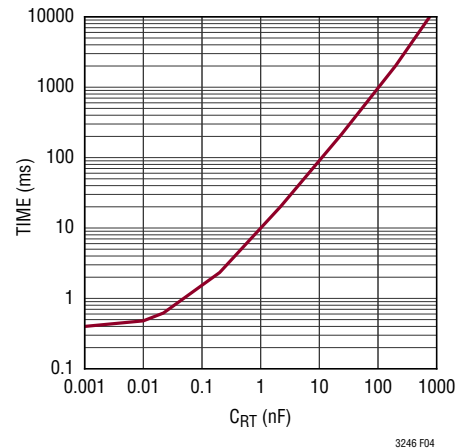

Figure 4. Reset Timeout Period vs  $C_{\text{RT}}$  Capacitance

### $\overline{\text{RST}}$ Output Characteristics

$\overline{\text{RST}}$  is an open-drain pin and, thus, requires an external pull-up resistor to a logic supply.  $\overline{\text{RST}}$  may be pulled up to any valid logic level (such as  $V_{\text{OUT}}$ ) providing the voltage limits of the pin are observed (See Absolute Maximum Ratings section).

### Watchdog Timer (WDI input, $\overline{\text{RST}}$ output)

The LTC3246 includes a windowed watchdog function that can continuously monitor the application's logic or microprocessor and issue automatic resets to aid recovery from unintended lockups or crashes. With the RSTI input held above threshold, the application must periodically toggle the logic state of the watchdog input (WDI pin) in order to clear the watchdog timer. Specifically, successive falling edges on the WDI pin must be spaced by more than the watchdog lower boundary but less than the watchdog upper boundary. As long as this condition holds,  $\overline{\text{RST}}$  remains high impedance.

If a falling edge arrives before the watchdog lower boundary, or if the watchdog timer reaches the upper boundary without seeing a falling edge on WDI, the watchdog timer immediately enters its reset state and asserts  $\overline{\text{RST}}$

## APPLICATIONS INFORMATION

low for the reset timeout period. Once the reset timeout completes,  $\overline{\text{RST}}$  is released to go high and the watchdog timer starts again.

During power-up, the watchdog timer remains cleared while  $\overline{\text{RST}}$  is asserted low. As soon as the reset timer times out,  $\overline{\text{RST}}$  goes high and the watchdog timer is started.

### Setting the Watchdog Timeout Period

The watchdog upper boundary ( $t_{\text{WDU}}$ ) and lower boundary ( $t_{\text{WDL}}$ ) are not observable outside the part; only the watchdog timeout period ( $t_{\text{WDR}}$ ) of the part is observable via the  $\overline{\text{RST}}$  pin. The watchdog upper boundary ( $t_{\text{WDU}}$ ) occurs one watchdog clock cycle before the watchdog timeout period ( $t_{\text{WDR}}$ ). The *internal* watchdog timeout period consists of 8193 clock cycles, so the *internal* watchdog upper boundary time is essentially the same as the internal watchdog timeout period. Conversely, the *external* watchdog timeout period consists of only 129 clock cycles, so the *external* watchdog upper boundary should be more accurately calculated as:

$$t_{\text{WDU(EXT)}} = t_{\text{WDR(EXT)}} \cdot \frac{128}{129}$$

The *external* watchdog lower boundary ( $t_{\text{WDL(EXT)}}$ ) occurs five clock cycles into the watchdog timeout period ( $t_{\text{WDR(EXT)}}$ ). Thus the *external* watchdog lower boundary can be calculated from the *external* watchdog timeout period as:

$$t_{\text{WDL(EXT)}} = t_{\text{WDR(EXT)}} \cdot \frac{5}{129}$$

The *internal* watchdog lower boundary can be calculated from the *internal* watchdog timeout period by the following:

$$t_{\text{WDL(INT)}} = \frac{t_{\text{WDR(INT)}}}{32}$$

The watchdog upper boundary is adjustable and can be optimized for software execution. The watchdog upper boundary is adjusted by connecting a capacitor,  $C_{\text{WT}}$ , between the WT and GND pins.

Figure 5 shows the approximate external watchdog timeout period as a function of the watchdog capacitor. Shorting WT to BIAS sets an upper and lower watchdog timeout period of about 50ms and 1.6s respectively.

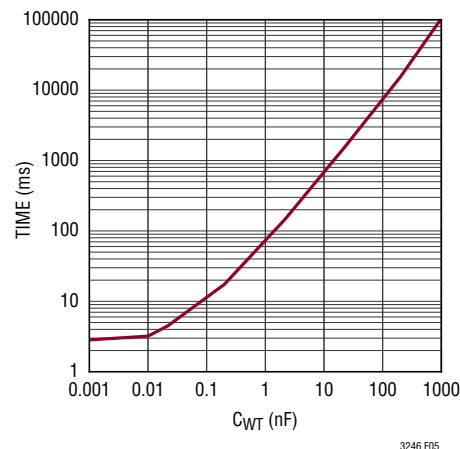

Figure 5. External Watchdog Timeout Period vs  $C_{\text{WT}}$  Capacitance

### Layout Considerations

Due to the high switching frequency and transient currents produced by the LTC3246, careful board layout is necessary for optimal performance. A true ground plane and short connections to all capacitors will optimize performance, reduce noise and ensure proper regulation over all conditions.

When using the LTC3246 with an external resistor divider it is important to minimize any stray capacitance to the ADJ (OUTS/ADJ pin) node. Stray capacitance from ADJ to  $C^+$  or  $C^-$  can degrade performance significantly and should be minimized and/or shielded if necessary. Minimize stray capacitance from WT and RT to  $C^+$  and  $C^-$  when using external timing capacitors to minimize timing variation.

### Thermal Management/Thermal Shutdown

The on-chip power dissipation in the LTC3246 will cause the junction to ambient temperature to rise at rate of typically 40°C/W in still air with a good thermal connection to the PC board. Connecting the die pad (Pin 17) with multiple vias to a large ground plane under the device can reduce the thermal resistance of the package and PC board con-



## APPLICATIONS INFORMATION

siderably. Poor board layout and failure to connect the die pad (Pin 17) to a large ground plane can result in thermal junction to ambient impedance well in excess of 40°C/W. It is also possible to get thermal rates less than 40°C/W with good airflow over the part and PC board.

Because of the wide input operating range, it is possible to exceed the specified operating junction temperature and even reach thermal shutdown (175°C typ). Figure 6 and Figure 7 show the available output current vs ambient temperature to ensure the 150°C operating junction temperature is not exceeded.

The figures assume worst-case operating conditions and a thermal impedance of 40°C/W. It is always safe to operate under the line shown on the graph. Operation above the line is conditional and is the responsibility of the user to calculate worst-case operating conditions (temperature and power) to make sure the part does not exceed the 150°C operating junction temperature for extended periods of time.

The 2:1 Step-Down Charge Pump Operation, 1:1 Step-Down Charge Pump Operation, and 1:2 Step-Up Charge Pump Operation sections provide equations for calculating power dissipation ( $P_D$ ) in each mode.

For example, if it is determined that the maximum power dissipation ( $P_D$ ) is 1.2W under normal operation, then the junction to ambient temperature rise will be:

$$T_{JA} = 1.2W \cdot 40^\circ\text{C/W} = 48^\circ\text{C}$$

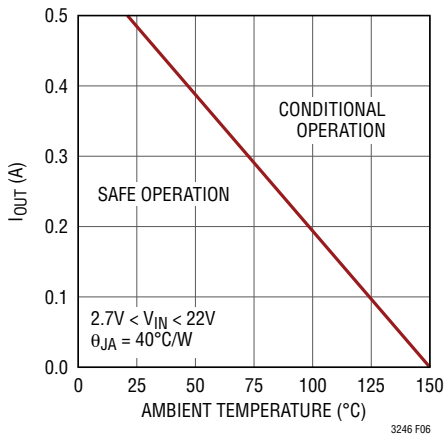

Figure 6. 5V Output Operation vs Ambient Temperature

Thus, the ambient temperature under this condition cannot exceed 102°C if the junction temperature is to remain below 150°C, and, if the ambient temperature exceeds about 127°C, the device will cycle in and out of the thermal shutdown.

Every application will have a slightly different thermal rise than the specified 40°C/W, especially applications with good airflow. Calculating the actual thermal rate for a specific application circuit is too complex to be presented here, but the thermal rate can be measured in application. This is done by first taking the final application circuit and enabling the LTC3246 under a known power dissipation ( $P_D$ ) and raising the ambient temperature slowly until the LTC3246 shuts down. Note this temperature as T1. Now, remove the load from the part and raise the ambient temperature slowly until the LTC3246 shuts down again. Note this temperature as T2. The thermal rate can be calculated as:

$$\theta_{JA} = P_D / (T_2 - T_1)$$

Another method for determining maximum safe operating temperature in application is to configure the LTC3246 to operate under the worst case operating power dissipation. Then slowly raise the ambient temperature until the LTC3246 shuts down. At this point the LTC3246 junction temperature will be about 175°C, so simply subtract 25°C from the shutdown temperature and this is the safe operating temperature for the application.

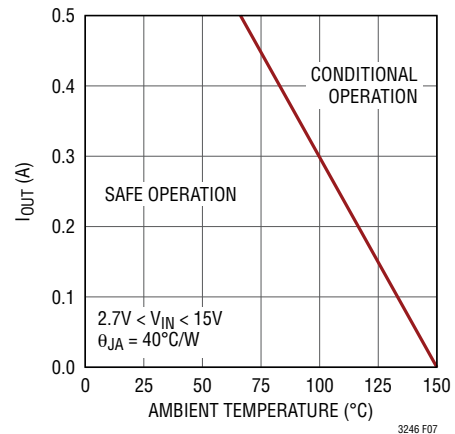
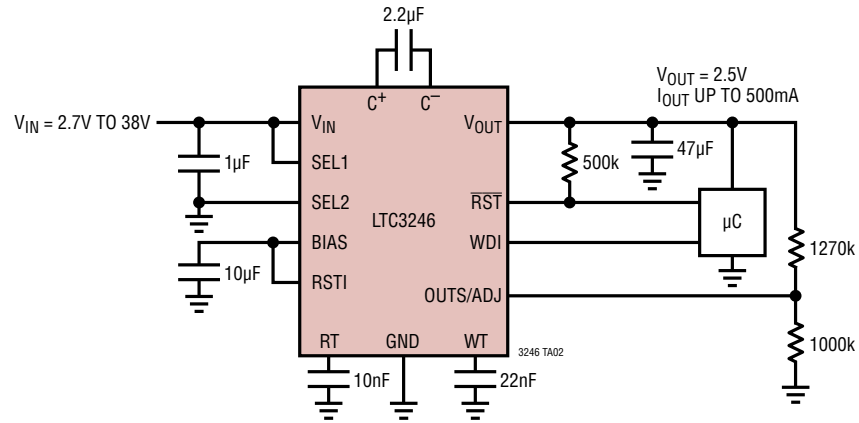

Figure 7. 3.3V Output Operation vs Ambient Temperature

## TYPICAL APPLICATIONS

### Regulated 2.5V Output with Externally Programmed Watchdog Timing



## PACKAGE DESCRIPTION

Please refer to <http://www.linear.com/product/LTC3246#packaging> for the most recent package drawings.

### MSE Package 16-Lead Plastic MSOP, Exposed Die Pad (Reference LTC DWG # 05-08-1667 Rev F)

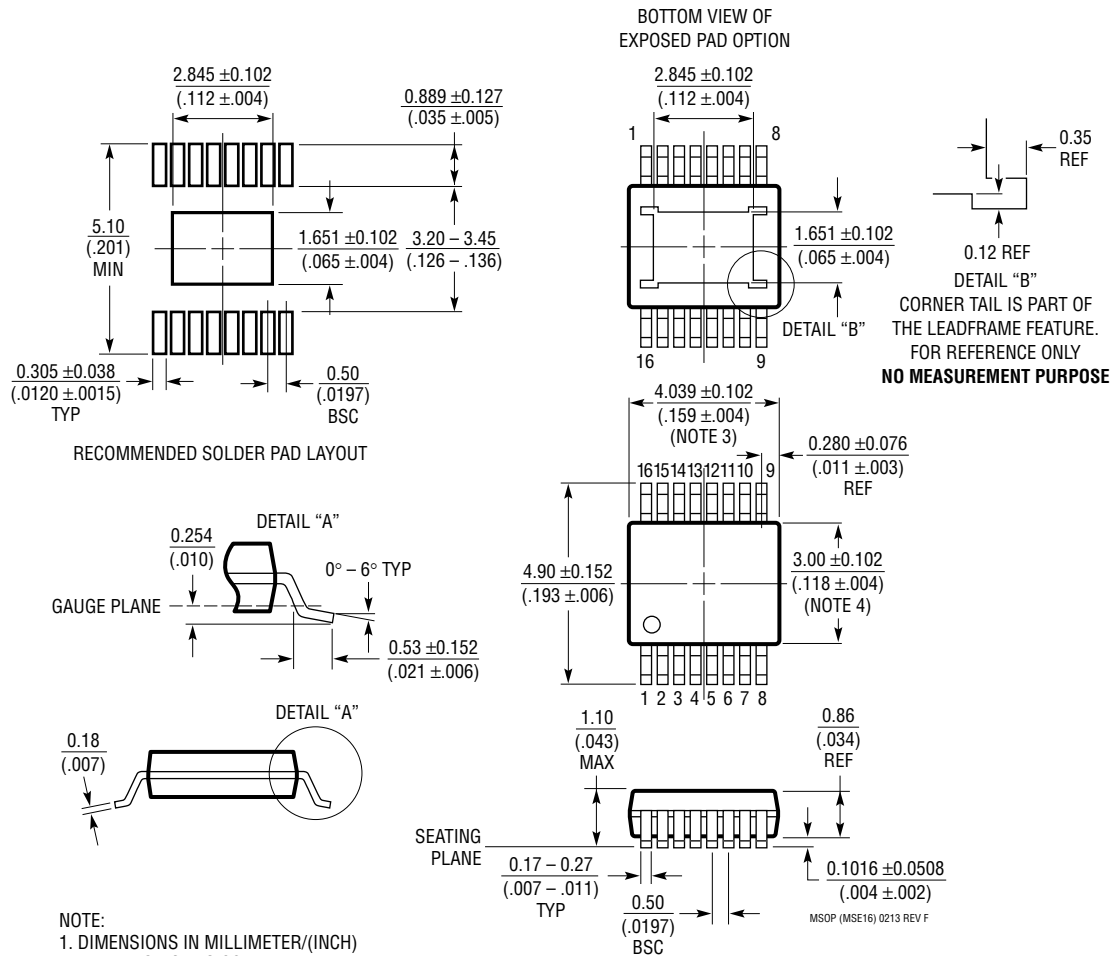

## REVISION HISTORY

REV	DATE	DESCRIPTION	PAGE NUMBER
A	12/17	Changed $R_{OUT}$ $V_{IN}$ condition	3
		Changed $V_{RSTL\_L}$ lower limit	3
		Changed $I_{OUT}$ equation resultant to 300mA and text to 150mA	10
		Changed circuit pin names	17

## TYPICAL APPLICATION

### Reduced Ripple 3.3V Output with Watchdog Timing Disabled

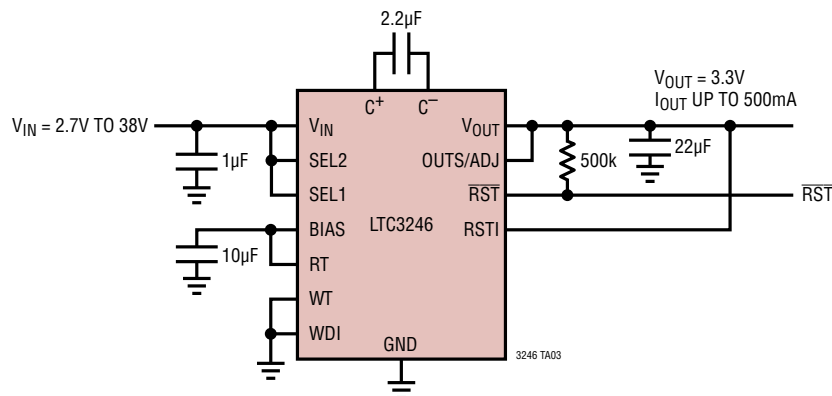

## RELATED PARTS

PART NUMBER	DESCRIPTION	COMMENTS
<a href="#">LTC3204-3.3/</a> <a href="#">LTC3204B-3.3/</a> <a href="#">LTC3204-5/</a> <a href="#">LTC3204B-5</a>	Low Noise, Regulated Charge Pumps in (2mm × 2mm) DFN Package	$V_{IN}$ : 1.8V to 4.5V (LTC3204B-3.3), 2.7V to 5.5V (LTC3204B-5), $I_Q = 48\mu\text{A}$ , B Version without Burst Mode Operation, 6-Lead (2mm × 2mm) DFN Package
<a href="#">LTC3440</a>	600mA ( $I_{OUT}$ ) 2MHz Synchronous Buck-Boost DC/DC Converter	95% Efficiency, $V_{IN}$ : 2.5V to 5.5V, $V_{OUT(MIN)} = 2.5V$ , $I_Q = 25\mu\text{A}$ , $I_{SD} \leq 1\mu\text{A}$ , 10-Lead MS Package
<a href="#">LTC3441</a>	High Current Micropower 1MHz Synchronous Buck-Boost DC/DC Converter	95% Efficiency, $V_{IN}$ : 2.5V to 5.5V, $V_{OUT(MIN)} = 2.5V$ , $I_Q = 25\mu\text{A}$ , $I_{SD} \leq 1\mu\text{A}$ , DFN Package
<a href="#">LTC3443</a>	High Current Micropower 600kHz Synchronous Buck-Boost DC/DC Converter	96% Efficiency, $V_{IN}$ : 2.4V to 5.5V, $V_{OUT(MIN)} = 2.4V$ , $I_Q = 28\mu\text{A}$ , $I_{SD} < 1\mu\text{A}$ , DFN Package
<a href="#">LTC3240-3.3/</a> <a href="#">LTC3240-2.5</a>	3.3V/2.5V Step-Up/Step-Down Charge Pump DC/DC Converter	$V_{IN}$ : 1.8V to 5.5V, $V_{OUT(MAX)} = 3.3V/2.5V$ , $I_Q = 65\mu\text{A}$ , $I_{SD} < 1\mu\text{A}$ , 2mm × 2mm DFN Package
<a href="#">LTC3260</a>	Low Noise Dual Supply Inverting Charge Pump	$V_{IN}$ Range: 4.5V to 32V, $I_Q = 100\mu\text{A}$ , 100mA Charge Pump, 50mA Positive LDO, 50mA Negative LDO
<a href="#">LTC3261</a>	High Voltage Low $I_Q$ Inverting Charge Pump	$V_{IN}$ Range: 4.5V to 32V, $I_Q = 60\mu\text{A}$ , 100mA Charge Pump
<a href="#">LTC3245</a>	High Voltage, Low Noise 250mA Buck-Boost Charge Pump	$V_{IN}$ Range: 2.7V to 38V, $V_{OUT}$ Range: 2.5V to 5V, $I_Q = 18\mu\text{A}$ , $I_{SD} = 4\mu\text{A}$ , 3mm × 4mm DFN and 12-Pin MSE Packages
<a href="#">LTC3255</a>	Wide $V_{IN}$ Range Fault Protected 50mA Step-Down Charge Pump	$V_{IN}$ Range: 4V to 48V, $V_{OUT}$ Range: 2.4V to 15V, $I_Q = 20\mu\text{A}$ , 10-Pin 3mm × 3mm DFN and MSE Packages
<a href="#">LTC3256</a>	Wide $V_{IN}$ Range Dual Output 350mA Step-Down Charge Pump with WDT	$V_{IN}$ Range: 5.5V to 38V, $V_{OUT}$ Range: 5V/3.3V, $I_Q = 18\mu\text{A}$ , 16-Pin MSE Package