



Chipsmall Limited consists of a professional team with an average of over 10 year of expertise in the distribution of electronic components. Based in Hongkong, we have already established firm and mutual-benefit business relationships with customers from,Europe,America and south Asia,supplying obsolete and hard-to-find components to meet their specific needs.

With the principle of “Quality Parts,Customers Priority,Honest Operation,and Considerate Service”,our business mainly focus on the distribution of electronic components. Line cards we deal with include Microchip,ALPS,ROHM,Xilinx,Pulse,ON,Everlight and Freescale. Main products comprise IC,Modules,Potentiometer,IC Socket,Relay,Connector.Our parts cover such applications as commercial,industrial, and automotives areas.

We are looking forward to setting up business relationship with you and hope to provide you with the best service and solution. Let us make a better world for our industry!



Contact us

Tel: +86-755-8981 8866 Fax: +86-755-8427 6832

Email & Skype: info@chipsmall.com Web: www.chipsmall.com

Address: A1208, Overseas Decoration Building, #122 Zhenhua RD., Futian, Shenzhen, China



Low I_Q, Dual, 2-Phase Synchronous Step-Down Controller

FEATURES

- **Wide Output Voltage Range: 0.8V ≤ V_{OUT} ≤ 10V**
- **Low Operating I_Q: 80μA (One Channel On)**
- **Out-of-Phase Controllers Reduce Required Input Capacitance and Power Supply Induced Noise**
- **OPTI-LOOP® Compensation Minimizes C_{OUT}**
- **±1% Output Voltage Accuracy**
- **Wide V_{IN} Range: 4V to 36V Operation**
- **Phase-Lockable Fixed Frequency 140kHz to 650kHz**
- **Selectable Continuous, Pulse Skipping or Low Ripple Burst Mode® Operation at Light Loads**
- **Dual N-Channel MOSFET Synchronous Drive**
- **Very Low Dropout Operation: 99% Duty Cycle**
- **Adjustable Output Voltage Soft-Start or Tracking**
- **Output Current Foldback Limiting**
- **Power Good Output Voltage Monitor**
- **Output Overvoltage Protection**
- **Low Shutdown I_Q: 8μA**
- **Internal LDO Powers Gate Drive from V_{IN} or V_{OUT}**
- **Small 5mm × 5mm QFN Package**

APPLICATIONS

- Automotive Systems
- Battery-Operated Digital Devices
- Distributed DC Power Systems

DESCRIPTION

The LTC[®]3827 is a high performance dual step-down switching regulator controller that drives all N-channel synchronous power MOSFET stages. A constant frequency current mode architecture allows a phase-lockable frequency of up to 650kHz. Power loss and noise due to the ESR of the input capacitor ESR are minimized by operating the two controller output stages out of phase.

The 80μA no-load quiescent current extends operating life in battery-powered systems. OPTI-LOOP compensation allows the transient response to be optimized over a wide range of output capacitance and ESR values. The LTC3827 features a precision 0.8V reference and a power good output indicator. A wide 4V to 36V input supply range encompasses all battery chemistries.

Independent TRACK/SS pins for each controller ramp the output voltage during start-up. Current foldback limits MOSFET heat dissipation during short-circuit conditions.

The PLLIN/MODE pin selects among Burst Mode operation, pulse skipping mode, or continuous inductor current mode at light loads. For a leaded package version (28-lead SSOP), see the LTC3827-1 datasheet.

LT, LT, LTC and LTM are registered trademarks of Linear Technology Corporation. Burst Mode and OPTI-LOOP are registered trademarks of Linear Technology Corporation. All other trademarks are the property of their respective owners. Protected by U.S. Patents including 5481178, 5929620, 6177787, 6144194, 5408150, 6580258, 6304066, 570919.

TYPICAL APPLICATION

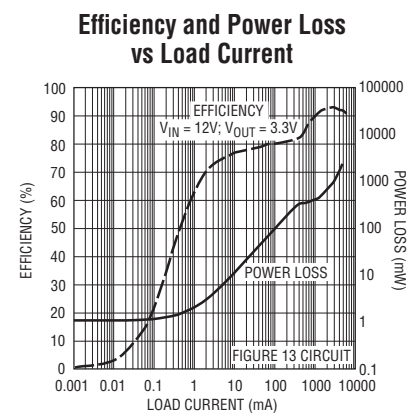
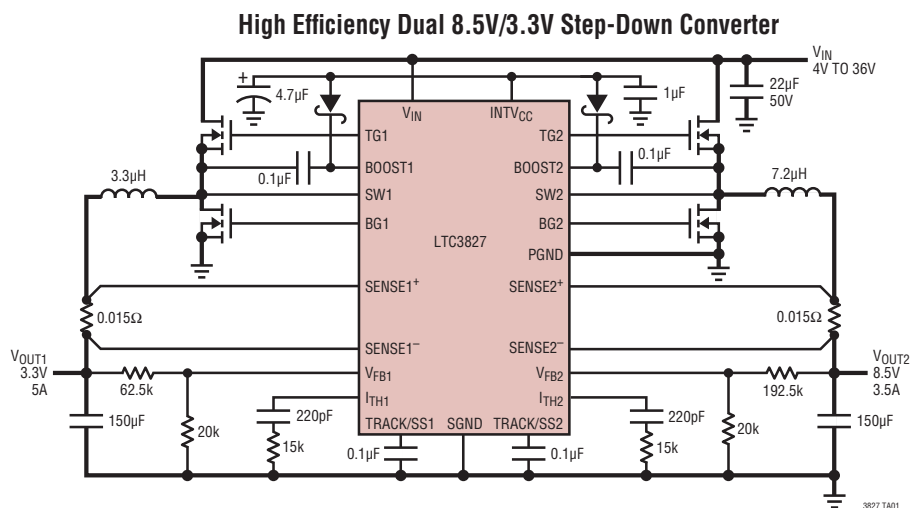

ABSOLUTE MAXIMUM RATINGS

(Note 1)

Input Supply Voltage (V_{IN})	36V to -0.3V
Topside Driver Voltages	
BOOST1, BOOST2	42V to -0.3V
Switch Voltage (SW1, SW2)	36V to -5V
BOOST1-SW1, BOOST2-SW2	8.5V to -0.3V
RUN1, RUN2	7V to -0.3V
SENSE1 ⁺ , SENSE2 ⁺ , SENSE1 ⁻ , SENSE2 ⁻ Voltages	11V to -0.3V
PLLIN/MODE, PLLLPF, Voltages	INTV _{CC} to -0.3V
PHASMD, FOLDDIS, TRACK/SS1, TRACK/SS2 Voltages	
EXTV _{CC}	INTV _{CC} to -0.3V
I _{TH1} , I _{TH2} , V _{FB1} , V _{FB2} Voltages	2.7V to -0.3V
PGOOD1, PGOOD2 Voltages	8.5V to -0.3V
Peak Output Current <10 μ s (TG1, TG2, BG1, BG2)	3A
INTV _{CC} Peak Output Current	50mA
Operating Temperature Range (Note 2)	-40°C to 85°C
Junction Temperature (Note 3)	125°C
Storage Temperature Range	-65°C to 125°C

PIN CONFIGURATION

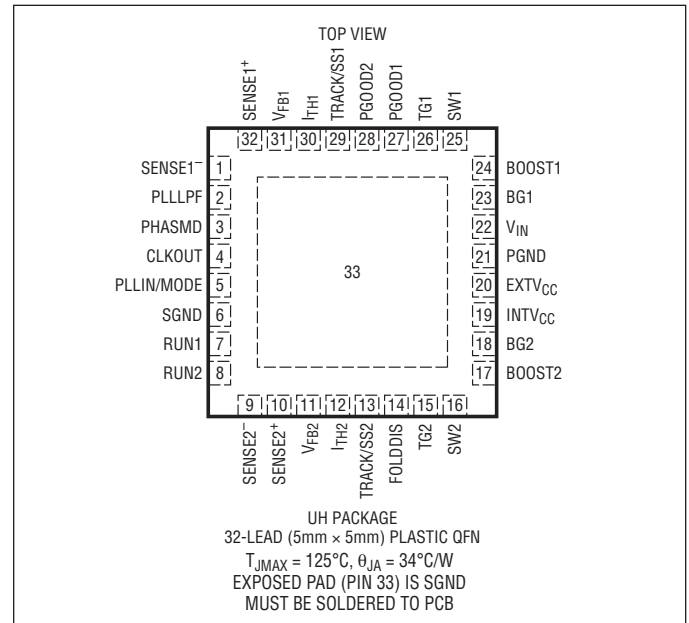

ORDER INFORMATION

LEAD FREE FINISH	TAPE AND REEL	PART MARKING*	PACKAGE DESCRIPTION	TEMPERATURE RANGE
LTC3827EUH#PBF	LTC3827EUH#TRPBF	3827	32-Lead (5mm x 5mm) Plastic QFN	-40°C to 85°C
LTC3827IUH#PBF	LTC3827IUH#TRPBF	3827	32-Lead (5mm x 5mm) Plastic QFN	-40°C to 85°C
LEAD BASED FINISH	TAPE AND REEL	PART MARKING*	PACKAGE DESCRIPTION	TEMPERATURE RANGE
LTC3827EUH	LTC3827EUH#TR	3827	32-Lead (5mm x 5mm) Plastic QFN	-40°C to 85°C
LTC3827IUH	LTC3827IUH#TR	3827	32-Lead (5mm x 5mm) Plastic QFN	-40°C to 85°C

Consult LTC Marketing for parts specified with wider operating temperature ranges. *The temperature grade is identified by a label on the shipping container.

For more information on lead free part marking, go to: <http://www.linear.com/leadfree/>

For more information on tape and reel specifications, go to: <http://www.linear.com/tapeandreel/>

ELECTRICAL CHARACTERISTICS

The ● denotes the specifications which apply over the full operating temperature range, otherwise specifications are at $T_A = 25^\circ\text{C}$. $V_{IN} = 12\text{V}$, $V_{RUN/SS1,2} = 5\text{V}$ unless otherwise noted.

SYMBOL	PARAMETER	CONDITIONS	MIN	TYP	MAX	UNITS	
Main Control Loops							
$V_{FB1,2}$	Regulated Feedback Voltage	(Note 4) $I_{TH1,2}$ Voltage = 1.2V	● 0.792	0.800	0.808	V	
$I_{VFB1,2}$	Feedback Current	(Note 4)		-5	-50	nA	
$V_{REFLNREG}$	Reference Voltage Line Regulation	$V_{IN} = 4\text{V}$ to 30V (Note 4)		0.002	0.02	%/V	
$V_{LOADREG}$	Output Voltage Load Regulation	(Note 4) Measured in Servo Loop; ΔI_{TH} Voltage = 1.2V to 0.7V Measured in Servo Loop; ΔI_{TH} Voltage = 1.2V to 2V	● ●	0.1 -0.1	0.5 -0.5	% %	
$g_{m1,2}$	Transconductance Amplifier g_m	$I_{TH1,2} = 1.2\text{V}$; Sink/Source $5\mu\text{A}$ (Note 4)		1.55		mmho	
I_Q	Input DC Supply Current	(Note 5)					
	Sleep Mode (Channel 1 On)	$RUN1 = 5\text{V}$, $RUN2 = 0\text{V}$, $V_{FB1} = 0.83\text{V}$ (No Load)		80	125	μA	
	Sleep Mode (Channel 2 On)	$RUN1 = 0\text{V}$, $RUN2 = 5\text{V}$, $V_{FB2} = 0.83\text{V}$ (No Load)		80	125	μA	
	Shutdown	$V_{RUN1,2} = 0\text{V}$		8	20	μA	
	Sleep Mode (Both Channels)	$RUN1,2 = 5\text{V}$, $V_{FB1} = V_{FB2} = 0.83\text{V}$		115	160	μA	
UVLO	Undervoltage Lockout	V_{IN} Ramping Down	●	3.5	4	V	
V_{OVL}	Feedback Overvoltage Lockout	Measured at $V_{FB1,2}$, Relative to Regulated $V_{FB1,2}$		8	10	12	%
I_{SENSE}	Sense Pins Total Source Current	(Each Channel) $V_{SENSE1-,2-} = V_{SENSE1+,2+} = 0\text{V}$		-660		μA	
DF_{MAX}	Maximum Duty Factor	In Dropout		98	99.4	%	
$I_{TRACK/SS1,2}$	Soft-Start Charge Current	$V_{TRACK1,2} = 0\text{V}$		0.75	1.0	1.35	μA
$V_{RUN1,2\text{ ON}}$	RUN Pin ON Threshold	$V_{RUN1,2}$ Rising		0.5	0.7	0.9	V
$V_{SENSE(MAX)}$	Maximum Current Sense Threshold	$V_{FB1,2} = 0.7\text{V}$, $V_{SENSE1-,2-} = 3.3\text{V}$ $V_{FB1,2} = 0.7\text{V}$, $V_{SENSE1-,2-} = 3.3\text{V}$	●	90 80	100 100	110 115	mV mV
$TG1,2 t_r$ $TG1,2 t_f$	TG Transition Time: Rise Time Fall Time	(Note 6) $C_{LOAD} = 3300\text{pF}$ $C_{LOAD} = 3300\text{pF}$		50 50	90 90	ns ns	
$BG1,2 t_r$ $BG1,2 t_f$	BG Transition Time: Rise Time Fall Time	(Note 6) $C_{LOAD} = 3300\text{pF}$ $C_{LOAD} = 3300\text{pF}$		40 40	90 80	ns ns	
$TG/BG t_{1D}$	Top Gate Off to Bottom Gate On Delay Synchronous Switch-On Delay Time	$C_{LOAD} = 3300\text{pF}$ Each Driver		70		ns	
$BG/TG t_{2D}$	Bottom Gate Off to Top Gate On Delay Top Switch-On Delay Time	$C_{LOAD} = 3300\text{pF}$ Each Driver		70		ns	
$t_{ON(MIN)}$	Minimum On-Time	(Note 7)		180		ns	
INTV_{CC} Linear Regulator							
$V_{INTVCCVIN}$	Internal V_{CC} Voltage	$8.5\text{V} < V_{IN} < 30\text{V}$, $V_{EXTVCC} = 0\text{V}$		5.0	5.25	5.5	V
V_{LDOVIN}	INTV _{CC} Load Regulation	$I_{CC} = 0\text{mA}$ to 20mA , $V_{EXTVCC} = 0\text{V}$		0.2	1.0	%	
$V_{INTVCCEXT}$	Internal V_{CC} Voltage	$V_{EXTVCC} = 8.5\text{V}$		7.2	7.5	7.8	V
V_{LDOEXT}	INTV _{CC} Load Regulation	$I_{CC} = 0\text{mA}$ to 20mA , $V_{EXTVCC} = 8.5\text{V}$		0.2	1.0	%	
V_{EXTVCC}	EXTV _{CC} Switchover Voltage	EXTV _{CC} Ramping Positive		4.5	4.7	V	
V_{LDOHYS}	EXTV _{CC} Hysteresis			0.2		V	
Oscillator and Phase-Locked Loop							
f_{NOM}	Nominal Frequency	$V_{PLLPF} = \text{Floating}$; $PLLIN/MODE = \text{DC Voltage}$		360	400	440	kHz
f_{LOW}	Lowest Frequency	$V_{PLLPF} = 0\text{V}$; $PLLIN/MODE = \text{DC Voltage}$		220	250	280	kHz
f_{HIGH}	Highest Frequency	$V_{PLLPF} = \text{INTV}_{CC}$; $PLLIN/MODE = \text{DC Voltage}$		475	530	580	kHz
$f_{SYNCMIN}$	Minimum Synchronizable Frequency	$PLLIN/MODE = \text{External Clock}$; $V_{PLLPF} = 0\text{V}$		115	140	kHz	

ELECTRICAL CHARACTERISTICS

The ● denotes the specifications which apply over the full operating temperature range, otherwise specifications are at $T_A = 25^\circ\text{C}$. $V_{IN} = 12\text{V}$, $V_{RUN/SS1, 2} = 5\text{V}$ unless otherwise noted.

SYMBOL	PARAMETER	CONDITIONS	MIN	TYP	MAX	UNITS
f_{SYNCMAX}	Maximum Synchronizable Frequency	PLLIN/MODE = External Clock; $V_{\text{PLLLPF}} = 2\text{V}$	650	800		kHz
I_{PLLLPF}	Phase Detector Output Current Sinking Capability Sourcing Capability	$f_{\text{PLLIN/MODE}} < f_{\text{OSC}}$ $f_{\text{PLLIN/MODE}} > f_{\text{OSC}}$		-5 5		μA μA
PGOOD Output						
V_{PGL}	PGOOD Voltage Low	$I_{\text{PGOOD}} = 2\text{mA}$		0.1	0.3	V
I_{PGOOD}	PGOOD Leakage Current	$V_{\text{PGOOD}} = 5\text{V}$			± 1	μA
V_{PG}	PGOOD Trip Level	V_{FB} with Respect to Set Regulated Voltage V_{FB} Ramping Negative V_{FB} Ramping Positive	-12 8	-10 10	-8 12	% %

Note 1: Stresses beyond those listed under Absolute Maximum Ratings may cause permanent damage to the device. Exposure to any Absolute Maximum Rating condition for extended periods may affect device reliability and lifetime.

Note 2: The LTC3827E is guaranteed to meet performance specifications from 0°C to 85°C . Specifications over the -40°C to 85°C operating temperature range are assured by design, characterization and correlation with statistical process controls. The LTC3827I is guaranteed to meet performance specifications over the full -40°C to 85°C operating temperature range.

Note 3: T_J is calculated from the ambient temperature T_A and power dissipation P_D according to the following formulas:

$$T_J = T_A + (P_D \cdot 34 \text{ } ^\circ\text{C/W})$$

Note 4: The LTC3827 is tested in a feedback loop that servos $V_{\text{ITH1, 2}}$ to a specified voltage and measures the resultant $V_{\text{FB1, 2}}$.

Note 5: Dynamic supply current is higher due to the gate charge being delivered at the switching frequency. See Applications Information.

Note 6: Rise and fall times are measured using 10% and 90% levels. Delay times are measured using 50% levels.

Note 7: The minimum on-time condition is specified for an inductor peak-to-peak ripple current $\geq 40\%$ of I_{MAX} (see minimum on-time considerations in the Applications Information section).

TYPICAL PERFORMANCE CHARACTERISTICS

Efficiency and Power Loss vs Output Current

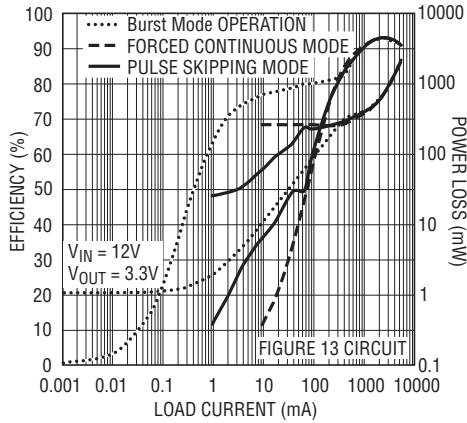

3827 G01

Efficiency vs Load Current

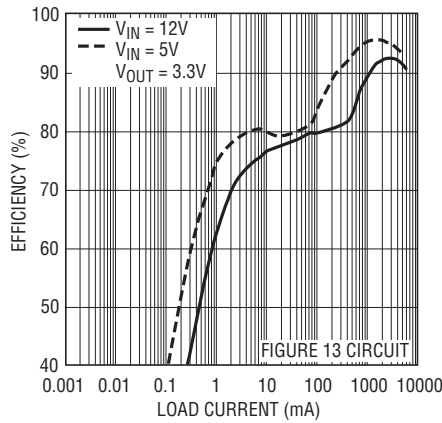

3827 G02

Efficiency vs Input Voltage

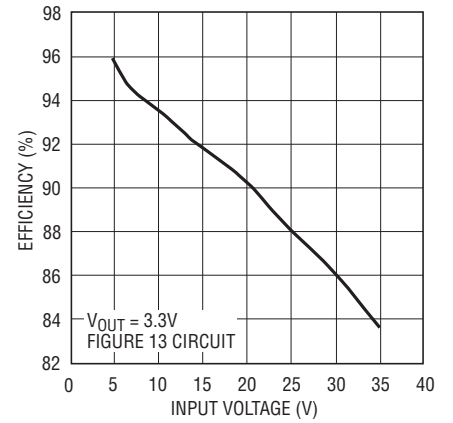

3827 G03

Load Step (Burst Mode Operation)

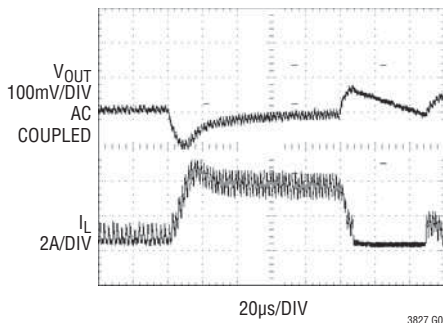

3827 G04

Load Step (Forced Continuous Mode)

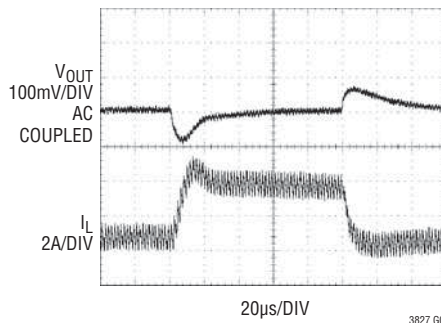

3827 G05

Load Step (Pulse Skip Mode)

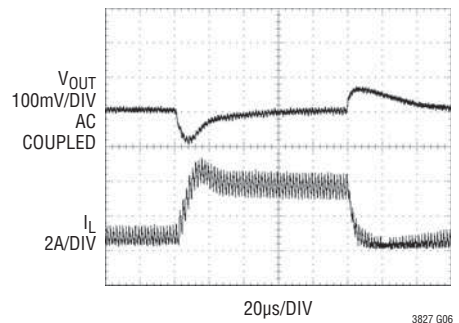

3827 G06

Inductor Current at Light Load

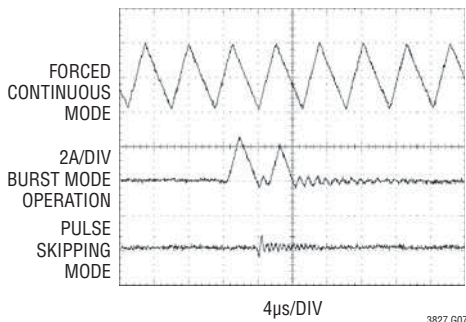

3827 G07

Soft Start-Up

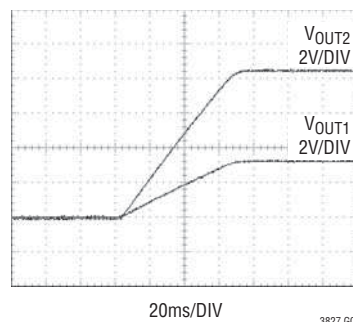

3827 G08

Tracking Start-Up

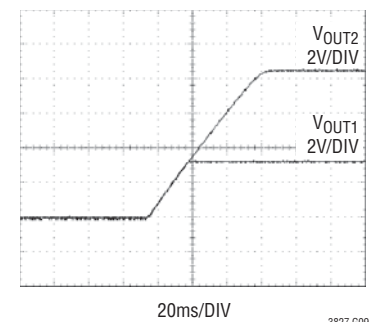

3827 G09

TYPICAL PERFORMANCE CHARACTERISTICS

Total Input Supply Current vs Input Voltage

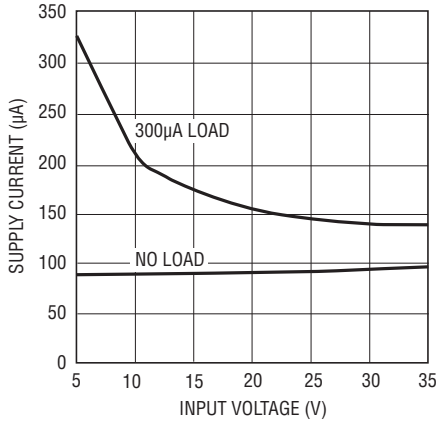

3827 G10

EXTV_{CC} Switchover and INTV_{CC} Voltages vs Temperature

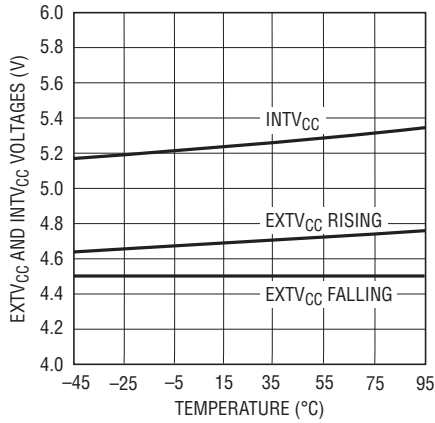

3827 G11

INTV_{CC} Line Regulation

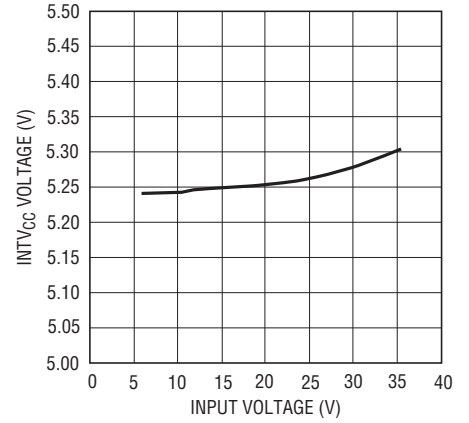

3827 G12

Maximum Current Sense Voltage vs I_{TH} Voltage

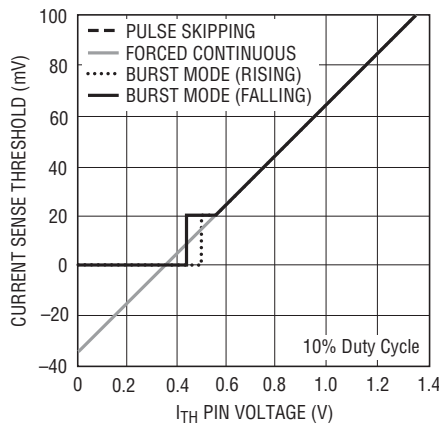

3827 G13

Sense Pins Total Input Bias Current

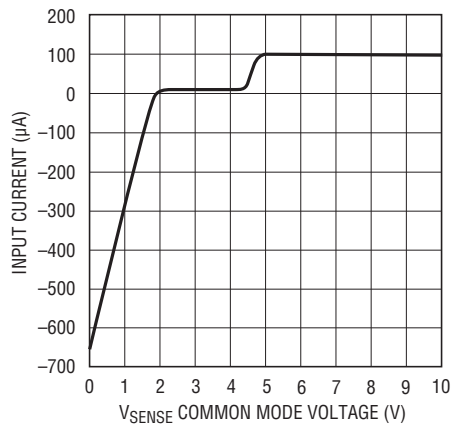

3827 G14

Maximum Current Sense Threshold vs Duty Cycle

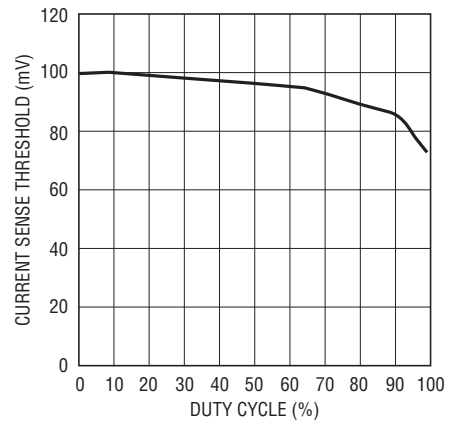

3827 G15

Foldback Current Limit

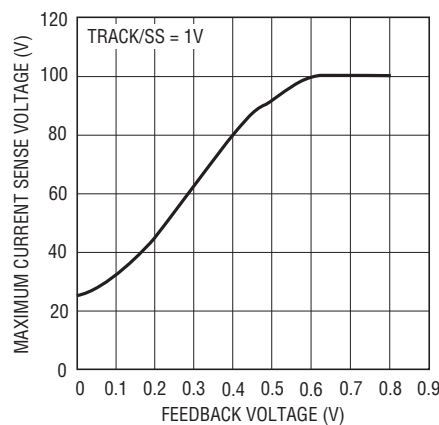

3827 G16

Quiescent Current vs Temperature

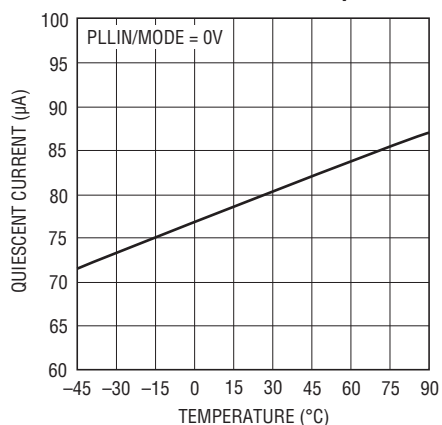

3827 G17

SENSE Pins Total Input Bias Current vs I_{TH}

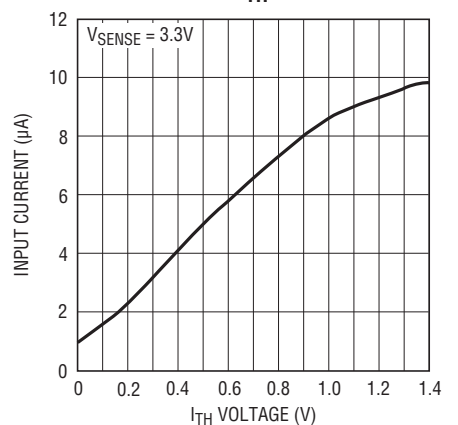

3827 G18

TYPICAL PERFORMANCE CHARACTERISTICS

TRACK/SS Pull-Up Current vs Temperature

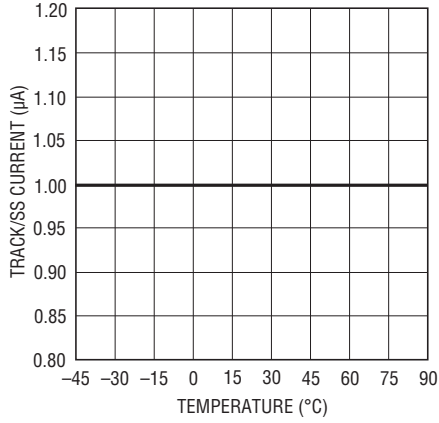

3827 G19

Shutdown (RUN) Threshold vs Temperature

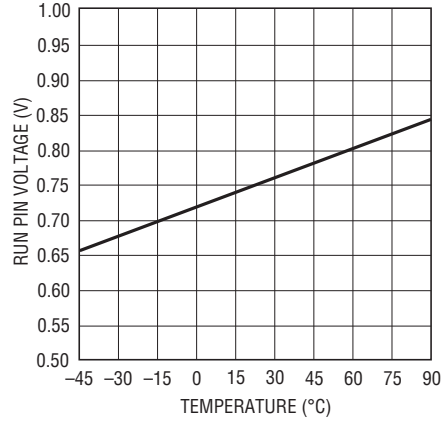

3827 G20

Regulated Feedback Voltage vs Temperature

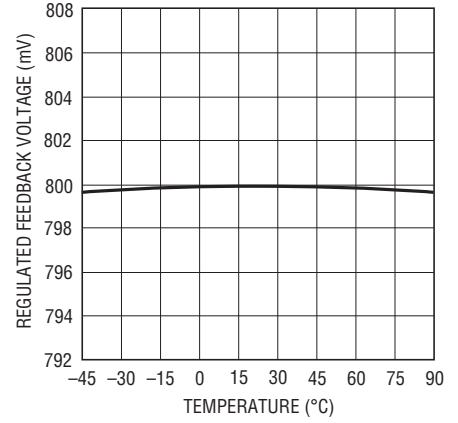

3827 G21

Sense Pins Total Input Current vs Temperature

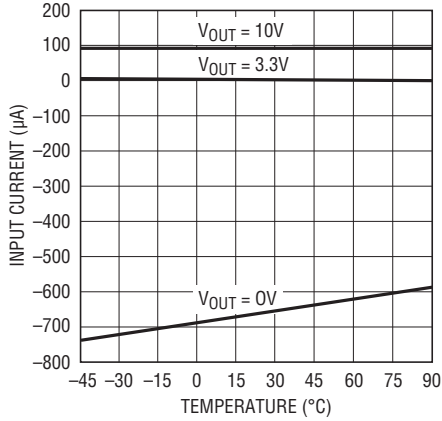

3827 G22

Shutdown Current vs Input Voltage

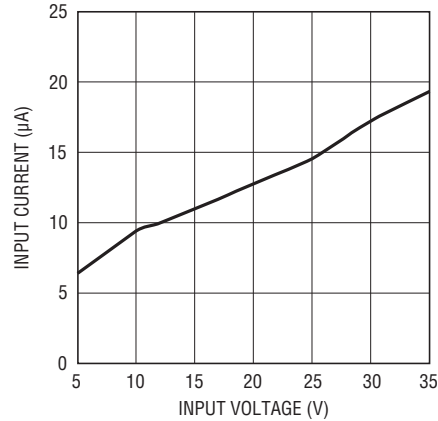

3827 G23

Oscillator Frequency vs Temperature

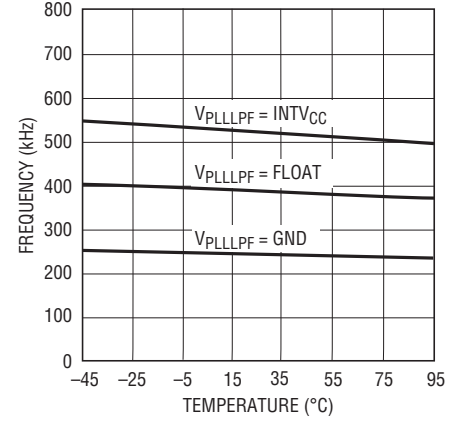

3827 G24

Undervoltage Lockout Threshold vs Temperature

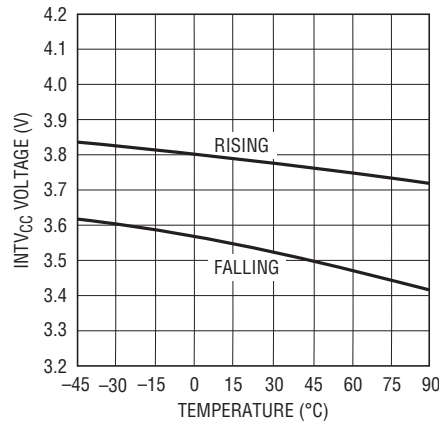

3827 G25

Oscillator Frequency vs Input Voltage

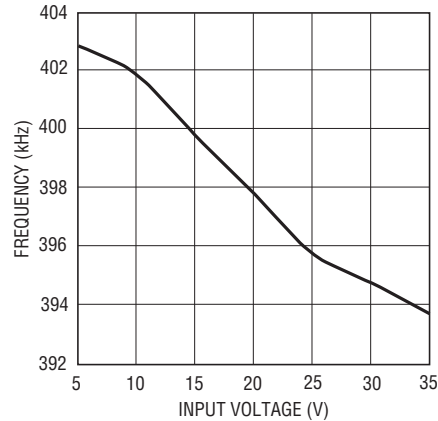

3827 G26

Shutdown Current vs Temperature

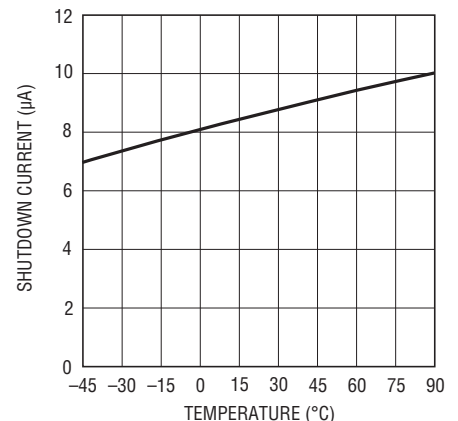

3827 G27

PIN FUNCTIONS

SENSE1⁻, SENSE2⁻ (Pins 1, 9): The (–) Input to the Differential Current Comparators.

PLLLPF (Pin 2): The phase-locked loop's lowpass filter is tied to this pin when synchronizing to an external clock. Alternatively, tie this pin to GND, INTV_{CC} or leave floating to select 250kHz, 530kHz or 400kHz switching frequency.

PHASMD (Pin 3): Control Input to Phase Selector which determines the phase relationships between controller 1, controller 2 and the CLKOUT signal.

CLKOUT (Pin 4): Output Clock Signal available to daisy-chain other controller ICs for additional MOSFET driver stages/phases.

PLLIN/MODE (Pin 5): External Synchronization Input to Phase Detector and Forced Continuous Control Input. When an external clock is applied to this pin, the phase-locked loop will force the rising TG1 signal to be synchronized with the rising edge of the external clock. In this case, an R-C filter must be connected to the PLLPF pin. When not synchronizing to an external clock, this input, which acts on both controllers, determines how the LTC3827 operates at light loads. Pulling this pin below 0.7V selects Burst Mode operation. Tying this pin to INTV_{CC} forces continuous inductor current operation. Tying this pin to a voltage greater than 0.9V and less than INTV_{CC} – 1.2V selects pulse skipping operation.

SGND (Pins 6, 33): Small-Signal Ground common to both controllers, must be routed separately from high current grounds to the common (–) terminals of the C_{IN} capacitors. The Exposed Pad is SGND. It must be soldered to PCB ground for rated thermal performance.

RUN1, RUN2 (Pins 7, 8): Digital Run Control Inputs for Each Controller. Forcing either of these pins below 0.7V shuts down that controller. Forcing both of these pins below 0.7V shuts down the entire LTC3827, reducing quiescent current to approximately 8μA.

FOLDDIS (Pin 14): Foldback Current Disable Input Pin. Driving this pin high (to INTV_{CC}) disables foldback current limiting during short-circuit or overcurrent conditions.

INTV_{CC} (Pin 19): Output of the Internal Linear Low Dropout Regulator. The driver and control circuits are powered from this voltage source. Must be decoupled to power ground with a minimum of 4.7μF tantalum or other low ESR capacitor.

EXTV_{CC} (Pin 20): External Power Input to an Internal LDO Connected to INTV_{CC}. This LDO supplies INTV_{CC} power, bypassing the internal LDO powered from V_{IN} whenever EXTV_{CC} is higher than 4.7V. See EXTV_{CC} Connection in the Applications Information section. Do not exceed 10V on this pin.

PGND (Pin 21): Driver Power Ground. Connects to the sources of bottom (synchronous) N-channel MOSFETs, anodes of the Schottky rectifiers and the (–) terminal(s) of C_{IN}.

V_{IN} (Pin 22): Main Supply Pin. A bypass capacitor should be tied between this pin and the signal ground pin.

BG1, BG2 (Pins 23, 18): High Current Gate Drives for Bottom (Synchronous) N-Channel MOSFETs. Voltage swing at these pins is from ground to INTV_{CC}.

BOOST1, BOOST2 (Pins 24, 17): Bootstrapped Supplies to the Topside Floating Drivers. Capacitors are connected between the BOOST and SW pins and Schottky diodes are tied between the BOOST and INTV_{CC} pins. Voltage swing at the BOOST pins is from INTV_{CC} to (V_{IN} + INTV_{CC}).

SW1, SW2 (Pins 25, 16): Switch Node Connections to Inductors. Voltage swing at these pins is from a Schottky diode (external) voltage drop below ground to V_{IN}.

TG1, TG2 (Pins 26, 15): High Current Gate Drives for Top N-Channel MOSFETs. These are the outputs of floating drivers with a voltage swing equal to INTV_{CC} – 0.5V superimposed on the switch node voltage SW.

PGOOD1 (Pin 27): Open-Drain Logic Output. PGOOD1 is pulled to ground when the voltage on the V_{FB1} pin is not within ±10% of its set point.

PGOOD2 (Pin 28): Open-Drain Logic Output. PGOOD2 is pulled to ground when the voltage on V_{FB2} pin is not within ±10% of its set point.

PIN FUNCTIONS

TRACK/SS1, TRACK/SS2 (Pins 29, 13): External Tracking and Soft-Start Input. The LTC3827 regulates the $V_{FB1,2}$ voltage to the smaller of 0.8V or the voltage on the TRACK/SS1,2 pin. An internal 1 μ A pull-up current source is connected to this pin. A capacitor to ground at this pin sets the ramp time to final regulated output voltage. Alternatively, a resistor divider on another voltage supply connected to this pin allows the LTC3827 output to track the other supply during startup.

I_{TH1}, I_{TH2} (Pins 30, 12): Error Amplifier Outputs and Switching Regulator Compensation Points. Each associated channel's current comparator trip point increases with this control voltage.

V_{FB1}, V_{FB2} (Pins 31, 11): Receives the remotely sensed feedback voltage for each controller from an external resistive divider across the output.

SENSE1⁺, SENSE2⁺ (Pins 32, 10): The (+) Input to the Differential Current Comparators. The I_{TH} pin voltage and controlled offsets between the SENSE⁻ and SENSE⁺ pins in conjunction with R_{SENSE} set the current trip threshold.

Exposed Pad (Pin 33): SGND. Must be soldered to the PCB.

OPERATION (Refer to Functional Diagram)

Main Control Loop

The LTC3827 uses a constant frequency, current mode step-down architecture with the two controller channels operating 180 degrees out of phase. During normal operation, each external top MOSFET is turned on when the clock for that channel sets the RS latch, and is turned off when the main current comparator, I_{CMP} , resets the RS latch. The peak inductor current at which I_{CMP} trips and resets the latch is controlled by the voltage on the I_{TH} pin, which is the output of the error amplifier EA. The error amplifier compares the output voltage feedback signal at the V_{FB} pin, (which is generated with an external resistor divider connected across the output voltage, V_{OUT} , to ground) to the internal 0.800V reference voltage. When the load current increases, it causes a slight decrease in V_{FB} relative to the reference, which causes the EA to increase the I_{TH} voltage until the average inductor current matches the new load current.

After the top MOSFET is turned off each cycle, the bottom MOSFET is turned on until either the inductor current starts to reverse, as indicated by the current comparator I_R , or the beginning of the next clock cycle.

INTV_{CC}/EXTV_{CC} Power

Power for the top and bottom MOSFET drivers and most other internal circuitry is derived from the INTV_{CC} pin. When the EXTV_{CC} pin is left open or tied to a voltage less than 4.7V, an internal 5.25V low dropout linear regulator supplies INTV_{CC} power from V_{IN} . If EXTV_{CC} is taken above 4.7V, the 5.25V regulator is turned off and a 7.5V low dropout linear regulator is enabled that supplies INTV_{CC} power from EXTV_{CC}. If EXTV_{CC} is less than 7.5V (but greater than 4.7V), the 7.5V regulator is in dropout and INTV_{CC} is approximately equal to EXTV_{CC}. When EXTV_{CC} is greater than 7.5V (up to an absolute maximum rating of 10V), INTV_{CC} is regulated to 7.5V. Using the EXTV_{CC} pin allows the INTV_{CC} power to be derived from a high efficiency external source such as one of the LTC3827 switching regulator outputs.

Each top MOSFET driver is biased from the floating bootstrap capacitor, C_B , which normally recharges during each off cycle through an external diode when the top MOSFET turns off. If the input voltage V_{IN} decreases to a voltage close to V_{OUT} , the loop may enter dropout and attempt to turn on the top MOSFET continuously. The dropout detector detects this and forces the top MOSFET off for about one twelfth of the clock period every tenth cycle to allow C_B to recharge.

Shutdown and Start-Up (RUN1, RUN2 and TRACK/SS1, TRACK/SS2 Pins)

The two channels of the LTC3827 can be independently shut down using the RUN1 and RUN2 pins. Pulling either of these pins below 0.7V shuts down the main control loop for that controller. Pulling both pins low disables both controllers and most internal circuits, including the INTV_{CC} regulator, and the LTC3827 draws only 8 μ A of quiescent current.

Releasing either RUN pin allows an internal 0.5 μ A current to pull up the pin and enable that controller. Alternatively, the RUN pin may be externally pulled up or driven directly by logic. Be careful not to exceed the Absolute Maximum rating of 7V on this pin.

The start-up of each controller's output voltage V_{OUT} is controlled by the voltage on the TRACK/SS1 and TRACK/SS2 pin. When the voltage on the TRACK/SS pin is less than the 0.8V internal reference, the LTC3827 regulates the V_{FB} voltage to the TRACK/SS pin voltage instead of the 0.8V reference. This allows the TRACK/SS pin to be used to program a soft-start by connecting an external capacitor from the TRACK/SS pin to SGND. An internal 1 μ A pull-up current charges this capacitor creating a voltage ramp on the TRACK/SS pin. As the TRACK/SS voltage rises linearly from 0V to 0.8V (and beyond), the output voltage V_{OUT} rises smoothly from zero to its final value.

Alternatively the TRACK/SS pin can be used to cause the start-up of V_{OUT} to "track" that of another supply. Typically, this requires connecting to the TRACK/SS pin an

OPERATION (Refer to Functional Diagram)

external resistor divider from the other supply to ground (see Applications Information section).

When the corresponding RUN pin is pulled low to disable a controller, or when V_{IN} drops below its undervoltage lockout threshold of 3.5V, the TRACK/SS pin is pulled low by an internal MOSFET. When in undervoltage lockout, both controllers are disabled and the external MOSFETs are held off.

Light Load Current Operation (Burst Mode Operation, Pulse Skipping or Continuous Conduction) (PLLIN/MODE Pin)

The LTC3827 can be enabled to enter high efficiency Burst Mode operation, constant frequency pulse skipping mode, or forced continuous conduction mode at low load currents. To select Burst Mode operation, tie the PLLIN/MODE pin to a DC voltage below 0.7V (e.g., SGND). To select forced continuous operation, tie the PLLIN/MODE pin to $INTV_{CC}$. To select pulse-skipping mode, tie the PLLIN/MODE pin to a DC voltage greater than 0.9V and less than $INTV_{CC} - 1.2V$.

When a controller is enabled for Burst Mode operation, the peak current in the inductor is set to approximately one-tenth of the maximum sense voltage even though the voltage on the I_{TH} pin indicates a lower value. If the average inductor current is lower than the load current, the error amplifier EA will decrease the voltage on the I_{TH} pin. When the I_{TH} voltage drops below 0.4V, the internal sleep signal goes high (enabling “sleep” mode) and both external MOSFETs are turned off. The I_{TH} pin is then disconnected from the output of the EA and “parked” at 0.425V.

In sleep mode, much of the internal circuitry is turned off, reducing the quiescent current that the LTC3827 draws. If one channel is shut down and the other channel is in sleep mode, the LTC3827 draws only 80 μ A of quiescent current. If both channels are in sleep mode, the LTC3827 draws only 115 μ A of quiescent current. In sleep mode, the load current is supplied by the output capacitor. As the output voltage decreases, the EA’s output begins to rise. When the output voltage drops enough, the I_{TH} pin is reconnected to the output of the EA, the sleep signal

goes low, and the controller resumes normal operation by turning on the top external MOSFET on the next cycle of the internal oscillator.

When a controller is enabled for Burst Mode operation, the inductor current is not allowed to reverse. The reverse current comparator (IR) turns off the bottom external MOSFET just before the inductor current reaches zero, preventing it from reversing and going negative. Thus, the controller operates in discontinuous operation.

In forced continuous operation, the inductor current is allowed to reverse at light loads or under large transient conditions. The peak inductor current is determined by the voltage on the I_{TH} pin, just as in normal operation. In this mode, the efficiency at light loads is lower than in Burst Mode operation. However, continuous has the advantages of lower output ripple and less interference to audio circuitry. In forced continuous mode, the output ripple is independent of load current.

When the PLLIN/MODE pin is connected for pulse skipping mode or clocked by an external clock source to use the phase-locked loop (see Frequency Selection and Phase-Locked Loop section), the LTC3827 operates in PWM pulse skipping mode at light loads. In this mode, constant frequency operation is maintained down to approximately 1% of designed maximum output current. At very light loads, the current comparator I_{CMP} may remain tripped for several cycles and force the external top MOSFET to stay off for the same number of cycles (i.e., skipping pulses). The inductor current is not allowed to reverse (discontinuous operation). This mode, like forced continuous operation, exhibits low output ripple as well as low audio noise and reduced RF interference as compared to Burst Mode operation. It provides higher low current efficiency than forced continuous mode, but not nearly as high as Burst Mode operation.

Frequency Selection and Phase-Locked Loop (PLLPF and PLLIN/MODE Pins)

The selection of switching frequency is a tradeoff between efficiency and component size. Low frequency operation increases efficiency by reducing MOSFET switching

OPERATION (Refer to Functional Diagram)

losses, but requires larger inductance and/or capacitance to maintain low output ripple voltage.

The switching frequency of the LTC3827's controllers can be selected using the PLLPF pin.

If the PLLIN/MODE pin is not being driven by an external clock source, the PLLPF pin can be floated, tied to $INTV_{CC}$, or tied to SGND to select 400kHz, 530kHz, or 250kHz, respectively.

A phase-locked loop (PLL) is available on the LTC3827 to synchronize the internal oscillator to an external clock source that is connected to the PLLIN/MODE pin. In this case, a series R-C should be connected between the PLLPF pin and SGND to serve as the PLL's loop filter. The LTC3827 phase detector adjusts the voltage on the PLLPF pin to align the turn-on of controller 1's external top MOSFET to the rising edge of the synchronizing signal. Thus, the turn-on of controller 2's external top MOSFET is 180 degrees out of phase to the rising edge of the external clock source.

The typical capture range of the LTC3827's phase-locked loop is from approximately 115kHz to 800kHz, with a guarantee over all manufacturing variations to be between 140kHz and 650kHz. In other words, the LTC3827's PLL is guaranteed to lock to an external clock source whose frequency is between 140kHz and 650kHz.

The typical input clock thresholds on the PLLIN/MODE pin are 1.6V (rising) and 1.2V (falling).

PolyPhase Applications (CLKOUT and PHASMD Pins)

The LTC3827 features two pins (CLKOUT and PHASMD) that allow other controller ICs to be daisy-chained with the LTC3827 in PolyPhase® applications. The clock output signal on the CLKOUT pin can be used to synchronize additional power stages in a multiphase power supply solution feeding a single, high current output or multiple separate outputs. The PHASMD pin is used to adjust the phase of the CLKOUT signal as well as the relative phases between the two internal controllers, as summarized in

Table 1. The phases are calculated relative to the zero degrees phase being defined as the rising edge of the top gate driver output of controller 1 (TG1).

Table 1

V_{PHASMD}	CONTROLLER 2 PHASE	CLKOUT PHASE
GND	180°	60°
Floating	180°	90°
$INTV_{CC}$	240°	120°

Output Overvoltage Protection

An overvoltage comparator guards against transient overshoots as well as other more serious conditions that may overvoltage the output. When the V_{FB} pin rises by more than 10% above its regulation point of 0.800V, the top MOSFET is turned off and the bottom MOSFET is turned on until the overvoltage condition is cleared.

Power Good (PGOOD1 and PGOOD2) Pins

Each PGOOD pin is connected to an open drain of an internal N-channel MOSFET. The MOSFET turns on and pulls the PGOOD pin low when the corresponding V_{FB} pin voltage is not within $\pm 10\%$ of the 0.8V reference voltage. The PGOOD pin is also pulled low when the corresponding RUN pin is low (shut down). When the V_{FB} pin voltage is within the $\pm 10\%$ requirement, the MOSFET is turned off and the pin is allowed to be pulled up by an external resistor to a source of up to 8.5V.

Foldback Current (FOLDDIS Pin)

When the output voltage falls to less than 70% of its nominal level, foldback current limiting is activated, progressively lowering the peak current limit in proportion to the severity of the overcurrent or short-circuit condition. Foldback current limiting is disabled during the soft-start interval (as long as the V_{FB} voltage is keeping up with the TRACK/SS voltage) or when the FOLDDIS pin is pulled high to $INTV_{CC}$.

PolyPhase is a registered trademark of Linear Technology Corporation.

OPERATION (Refer to Functional Diagram)

THEORY AND BENEFITS OF 2-PHASE OPERATION

Why the need for 2-phase operation? Up until the 2-phase family, constant-frequency dual switching regulators operated both channels in phase (i.e., single-phase operation). This means that both switches turned on at the same time, causing current pulses of up to twice the amplitude of those for one regulator to be drawn from the input capacitor and battery. These large amplitude current pulses increased the total RMS current flowing from the input capacitor, requiring the use of more expensive input capacitors and increasing both EMI and losses in the input capacitor and battery.

With 2-phase operation, the two channels of the dual-switching regulator are operated 180 degrees out of phase. This effectively interleaves the current pulses drawn by the

switches, greatly reducing the overlap time where they add together. *The result is a significant reduction in total RMS input current, which in turn allows less expensive input capacitors to be used, reduces shielding requirements for EMI and improves real world operating efficiency.*

Figure 1 compares the input waveforms for a representative single-phase dual switching regulator to the LTC3827 2-phase dual switching regulator. An actual measurement of the RMS input current under these conditions shows that 2-phase operation dropped the input current from $2.53A_{RMS}$ to $1.55A_{RMS}$. While this is an impressive reduction in itself, remember that the power losses are proportional to I_{RMS}^2 , meaning that the actual power wasted is reduced by a factor of 2.66. The reduced input ripple voltage also means less power is lost in the input power path, which could

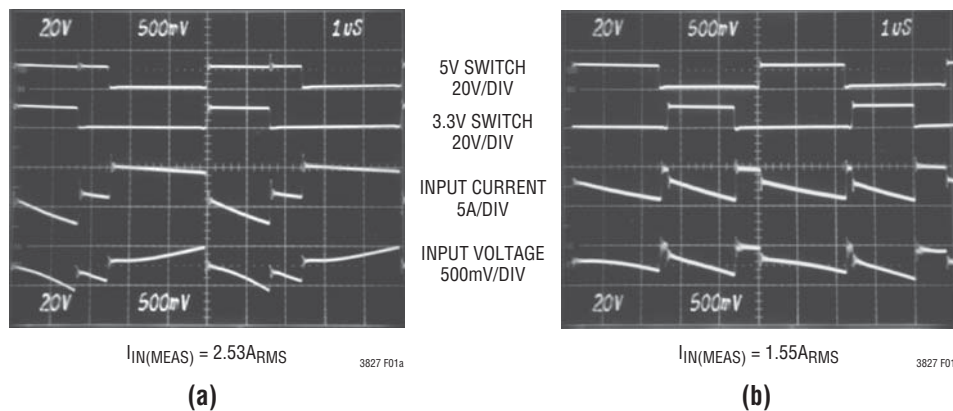

Figure 1. Input Waveforms Comparing Single-Phase (a) and 2-Phase (b) Operation for Dual Switching Regulators Converting 12V to 5V and 3.3V at 3A Each. The Reduced Input Ripple with the 2-Phase Regulator Allows Less Expensive Input Capacitors, Reduces Shielding Requirements for EMI and Improves Efficiency

OPERATION (Refer to Functional Diagram)

include batteries, switches, trace/connector resistances and protection circuitry. Improvements in both conducted and radiated EMI also directly accrue as a result of the reduced RMS input current and voltage.

Of course, the improvement afforded by 2-phase operation is a function of the dual switching regulator's relative duty cycles which, in turn, are dependent upon the input voltage V_{IN} (Duty Cycle = V_{OUT}/V_{IN}). Figure 2 shows how the RMS input current varies for single-phase and 2-phase operation for 3.3V and 5V regulators over a wide input voltage range.

It can readily be seen that the advantages of 2-phase operation are not just limited to a narrow operating range, for most applications is that 2-phase operation will reduce the input capacitor requirement to that for just one channel operating at maximum current and 50% duty cycle.

The schematic on the first page is a basic LTC3827 application circuit. External component selection is driven by the load requirement, and begins with the selection of R_{SENSE} and the inductor value. Next, the power MOSFETs are selected. Finally, C_{IN} and C_{OUT} are selected.

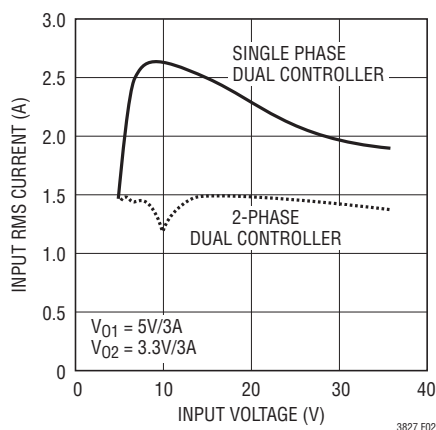

Figure 2. RMS Input Current Comparison

APPLICATIONS INFORMATION

R_{SENSE} Selection for Output Current

R_{SENSE} is chosen based on the required output current. The current comparator has a maximum threshold of 100mV/R_{SENSE} and an input common mode range of SGND to 10V. The current comparator threshold sets the peak of the inductor current, yielding a maximum average output current I_{MAX} equal to the peak value less half the peak-to-peak ripple current, ΔI_L.

Allowing a margin for variations in the IC and external component values yields:

$$R_{\text{SENSE}} = \frac{80\text{mV}}{I_{\text{MAX}}}$$

When using the controller in very low dropout conditions, the maximum output current level will be reduced due to the internal compensation required to meet stability criterion for buck regulators operating at greater than 50% duty factor. A curve is provided in the Typical Performance Characteristics section to estimate this reduction in peak output current level depending upon the operating duty factor.

Operating Frequency and Synchronization

The choice of operating frequency, is a trade-off between efficiency and component size. Low frequency operation improves efficiency by reducing MOSFET switching losses, both gate charge loss and transition loss. However, lower frequency operation requires more inductance for a given amount of ripple current.

The internal oscillator for each of the LTC3827's controllers runs at a nominal 400kHz frequency when the PLLLPF pin is left floating and the PLLIN/MODE pin is a DC low or high. Pulling the PLLLPF to INTV_{CC} selects 530kHz operation; pulling the PLLLPF to SGND selects 250kHz operation.

Alternatively, the LTC3827 will phase-lock to a clock signal applied to the PLLIN/MODE pin with a frequency between 140kHz and 650kHz (see Phase-Locked Loop and Frequency Synchronization).

Inductor Value Calculation

The operating frequency and inductor selection are inter-related in that higher operating frequencies allow the use of smaller inductor and capacitor values. So why would anyone ever choose to operate at lower frequencies with larger components? The answer is efficiency. A higher frequency generally results in lower efficiency because of MOSFET gate charge losses. In addition to this basic trade-off, the effect of inductor value on ripple current and low current operation must also be considered.

The inductor value has a direct effect on ripple current. The inductor ripple current ΔI_L decreases with higher inductance or frequency and increases with higher V_{IN}:

$$\Delta I_L = \frac{1}{(f)(L)} V_{\text{OUT}} \left(1 - \frac{V_{\text{OUT}}}{V_{\text{IN}}} \right)$$

Accepting larger values of ΔI_L allows the use of low inductances, but results in higher output voltage ripple and greater core losses. A reasonable starting point for setting ripple current is ΔI_L = 0.3(I_{MAX}). The maximum ΔI_L occurs at the maximum input voltage.

The inductor value also has secondary effects. The transition to Burst Mode operation begins when the average inductor current required results in a peak current below 10% of the current limit determined by R_{SENSE}. Lower inductor values (higher ΔI_L) will cause this to occur at lower load currents, which can cause a dip in efficiency in the upper range of low current operation. In Burst Mode operation, lower inductance values will cause the burst frequency to decrease.

Inductor Core Selection

Once the value for L is known, the type of inductor must be selected. High efficiency converters generally cannot afford the core loss found in low cost powdered iron cores, forcing the use of more expensive ferrite or molypermalloy cores. Actual core loss is independent of core size for a fixed inductor value, but it is very dependent on inductance

APPLICATIONS INFORMATION

selected. As inductance increases, core losses go down. Unfortunately, increased inductance requires more turns of wire and therefore copper losses will increase.

Ferrite designs have very low core loss and are preferred at high switching frequencies, so design goals can concentrate on copper loss and preventing saturation. Ferrite core material saturates “hard,” which means that inductance collapses abruptly when the peak design current is exceeded. This results in an abrupt increase in inductor ripple current and consequent output voltage ripple. Do not allow the core to saturate!

Power MOSFET and Schottky Diode (Optional) Selection

Two external power MOSFETs must be selected for each controller in the LTC3827: one N-channel MOSFET for the top (main) switch, and one N-channel MOSFET for the bottom (synchronous) switch.

The peak-to-peak drive levels are set by the $INTV_{CC}$ voltage. This voltage is typically 5V during start-up (see $EXTV_{CC}$ Pin Connection). Consequently, logic-level threshold MOSFETs must be used in most applications. The only exception is if low input voltage is expected ($V_{IN} < 5V$); then, sub-logic level threshold MOSFETs ($V_{GS(TH)} < 3V$) should be used. Pay close attention to the BV_{DSS} specification for the MOSFETs as well; most of the logic level MOSFETs are limited to 30V or less.

Selection criteria for the power MOSFETs include the “ON” resistance, $R_{DS(ON)}$, Miller capacitance, C_{MILLER} , input voltage and maximum output current. Miller capacitance, C_{MILLER} , can be approximated from the gate charge curve usually provided on the MOSFET manufacturers’ data sheet. C_{MILLER} is equal to the increase in gate charge along the horizontal axis while the curve is approximately flat divided by the specified change in V_{DS} . This result is then multiplied by the ratio of the application applied V_{DS} to the Gate charge curve specified V_{DS} . When the IC is

operating in continuous mode the duty cycles for the top and bottom MOSFETs are given by:

$$\text{Main Switch Duty Cycle} = \frac{V_{OUT}}{V_{IN}}$$

$$\text{Synchronous Switch Duty Cycle} = \frac{V_{IN} - V_{OUT}}{V_{IN}}$$

The MOSFET power dissipations at maximum output current are given by:

$$P_{MAIN} = \frac{V_{OUT}}{V_{IN}} (I_{MAX})^2 (1 + \delta) R_{DS(ON)} + (V_{IN})^2 \left(\frac{I_{MAX}}{2} \right) (R_{DR}) (C_{MILLER}) \cdot \left[\frac{1}{V_{INTVCC} - V_{THMIN}} + \frac{1}{V_{THMIN}} \right] (f)$$

$$P_{SYNC} = \frac{V_{IN} - V_{OUT}}{V_{IN}} (I_{MAX})^2 (1 + \delta) R_{DS(ON)}$$

where δ is the temperature dependency of $R_{DS(ON)}$ and R_{DR} (approximately 2Ω) is the effective driver resistance at the MOSFET’s Miller threshold voltage. V_{THMIN} is the typical MOSFET minimum threshold voltage.

Both MOSFETs have I^2R losses while the topside N-channel equation includes an additional term for transition losses, which are highest at high input voltages. For $V_{IN} < 20V$ the high current efficiency generally improves with larger MOSFETs, while for $V_{IN} > 20V$ the transition losses rapidly increase to the point that the use of a higher $R_{DS(ON)}$ device with lower C_{MILLER} actually provides higher efficiency. The synchronous MOSFET losses are greatest at high input voltage when the top switch duty factor is low or during a short-circuit when the synchronous switch is on close to 100% of the period.

APPLICATIONS INFORMATION

The term $(1 + \delta)$ is generally given for a MOSFET in the form of a normalized $R_{DS(ON)}$ vs Temperature curve, but $\delta = 0.005/^\circ\text{C}$ can be used as an approximation for low voltage MOSFETs.

The optional Schottky diodes D3 and D4 shown in Figure 14 conduct during the dead-time between the conduction of the two power MOSFETs. This prevents the body diode of the bottom MOSFET from turning on, storing charge during the dead-time and requiring a reverse recovery period that could cost as much as 3% in efficiency at high V_{IN} . A 1A to 3A Schottky is generally a good compromise for both regions of operation due to the relatively small average current. Larger diodes result in additional transition losses due to their larger junction capacitance.

C_{IN} and C_{OUT} Selection

The selection of C_{IN} is simplified by the 2-phase architecture and its impact on the worst-case RMS current drawn through the input network (battery/fuse/capacitor). It can be shown that the worst-case capacitor RMS current occurs when only one controller is operating. The controller with the highest $(V_{OUT})(I_{OUT})$ product needs to be used in the formula below to determine the maximum RMS capacitor current requirement. Increasing the output current drawn from the other controller will actually decrease the input RMS ripple current from its maximum value. The out-of-phase technique typically reduces the input capacitor's RMS ripple current by a factor of 30% to 70% when compared to a single phase power supply solution.

In continuous mode, the source current of the top MOSFET is a square wave of duty cycle $(V_{OUT})/(V_{IN})$. To prevent large voltage transients, a low ESR capacitor sized for the maximum RMS current of one channel must be used. The maximum RMS capacitor current is given by:

$$C_{IN} \text{ Required } I_{RMS} \approx \frac{I_{MAX}}{V_{IN}} [(V_{OUT})(V_{IN} - V_{OUT})]^{1/2}$$

This formula has a maximum at $V_{IN} = 2V_{OUT}$, where $I_{RMS} = I_{OUT}/2$. This simple worst-case condition is commonly used for design because even significant deviations do not

offer much relief. Note that capacitor manufacturers' ripple current ratings are often based on only 2000 hours of life. This makes it advisable to further derate the capacitor, or to choose a capacitor rated at a higher temperature than required. Several capacitors may be paralleled to meet size or height requirements in the design. Due to the high operating frequency of the LTC3827, ceramic capacitors can also be used for C_{IN} . Always consult the manufacturer if there is any question.

The benefit of the LTC3827 2-phase operation can be calculated by using the equation above for the higher power controller and then calculating the loss that would have resulted if both controller channels switched on at the same time. The total RMS power lost is lower when both controllers are operating due to the reduced overlap of current pulses required through the input capacitor's ESR. This is why the input capacitor's requirement calculated above for the worst-case controller is adequate for the dual controller design. Also, the input protection fuse resistance, battery resistance, and PC board trace resistance losses are also reduced due to the reduced peak currents in a 2-phase system. The overall benefit of a multiphase design will only be fully realized when the source impedance of the power supply/battery is included in the efficiency testing. The sources of the top MOSFETs should be placed within 1cm of each other and share a common $C_{IN}(s)$. Separating the sources and C_{IN} may produce undesirable voltage and current resonances at V_{IN} .

A small (0.1 μF to 1 μF) bypass capacitor between the chip V_{IN} pin and ground, placed close to the LTC3827, is also suggested. A 10 Ω resistor placed between C_{IN} (C1) and the V_{IN} pin provides further isolation between the two channels.

The selection of C_{OUT} is driven by the effective series resistance (ESR). Typically, once the ESR requirement is satisfied, the capacitance is adequate for filtering. The output ripple (ΔV_{OUT}) is approximated by:

$$\Delta V_{OUT} \approx I_{RIPPLE} \left(\text{ESR} + \frac{1}{8fC_{OUT}} \right)$$

APPLICATIONS INFORMATION

where f is the operating frequency, C_{OUT} is the output capacitance and I_{RIPPLE} is the ripple current in the inductor. The output ripple is highest at maximum input voltage since I_{RIPPLE} increases with input voltage.

Setting Output Voltage

The LTC3827 output voltages are each set by an external feedback resistor divider carefully placed across the output, as shown in Figure 3. The regulated output voltage is determined by:

$$V_{OUT} = 0.8V \cdot \left(1 + \frac{R_B}{R_A} \right)$$

To improve the frequency response, a feed-forward capacitor, C_{FF} , may be used. Great care should be taken to route the V_{FB} line away from noise sources, such as the inductor or the SW line.

SENSE⁺ and SENSE⁻ Pins

The common mode input range of the current comparator is from 0V to 10V. Continuous linear operation is provided throughout this range allowing output voltages from 0.8V to 10V. The input stage of the current comparator requires that current either be sourced or sunk from the SENSE pins depending on the output voltage, as shown in the curve in Figure 4. If the output voltage is below 1.5V, current will flow out of both SENSE pins to the main output. In these cases, the output can be easily pre-loaded by the V_{OUT}

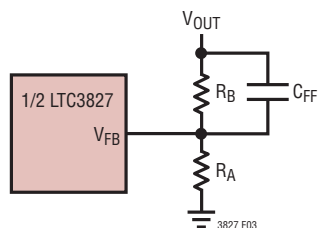

Figure 3. Setting Output Voltage

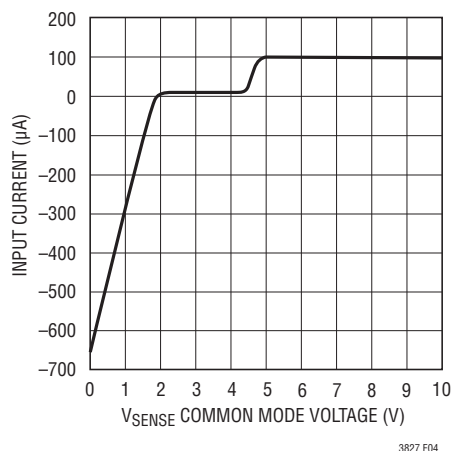

Figure 4. SENSE Pins Input Bias Current vs Common Mode (Output) Voltage

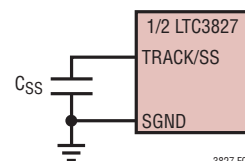

Figure 5. Using the TRACK/SS Pin to Program Soft-Start

resistor divider to compensate for the current comparator's negative input bias current. Since V_{FB} is servoed to the 0.8V reference voltage, R_A in Figure 3 should be chosen to be less than $0.8V/I_{SENSE}$, with I_{SENSE} determined from Figure 4 at the specified output voltage.

Tracking and Soft-Start (TRACK/SS Pins)

The start-up of each V_{OUT} is controlled by the voltage on the respective TRACK/SS pin. When the voltage on the TRACK/SS pin is less than the internal 0.8V reference, the LTC3827 regulates the V_{FB} pin voltage to the voltage on the TRACK/SS pin instead of 0.8V. The TRACK/SS pin can be used to program an external soft-start function or to allow V_{OUT} to “track” another supply during start-up.

Soft-start is enabled by simply connecting a capacitor from the TRACK/SS pin to ground, as shown in Figure 5. An internal $1\mu A$ current source charges up the capacitor,

APPLICATIONS INFORMATION

providing a linear ramping voltage at the TRACK/SS pin. The LTC3827 will regulate the V_{FB} pin (and hence V_{OUT}) according to the voltage on the TRACK/SS pin, allowing V_{OUT} to rise smoothly from 0V to its final regulated value. The total soft-start time will be approximately:

$$t_{SS} = C_{SS} \cdot \frac{0.8V}{1\mu A}$$

Alternatively, the TRACK/SS pin can be used to track two (or more) supplies during start-up, as shown qualitatively in Figures 6a and 6b. To do this, a resistor divider should be connected from the master supply (V_X) to the TRACK/SS pin of the slave supply (V_{OUT}), as shown in Figure 7. During start-up V_{OUT} will track V_X according to the ratio

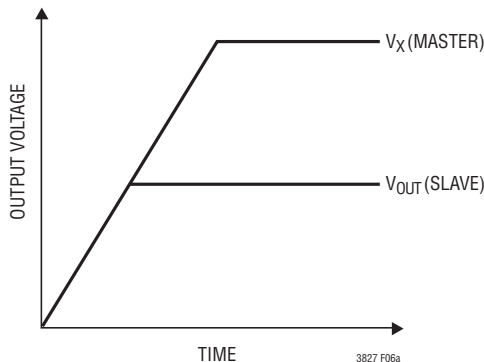

(6a) Coincident Tracking

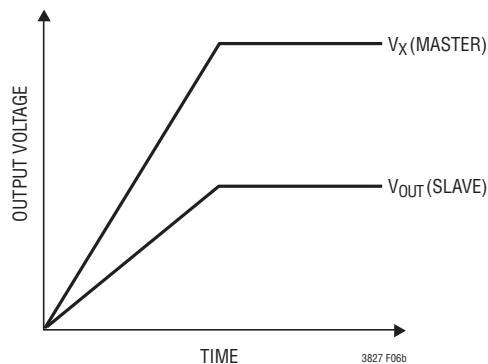

(6b) Ratiometric Tracking

Figure 6. Two Different Modes of Output Voltage Tracking

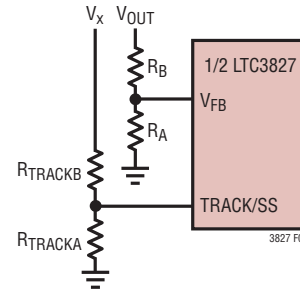

Figure 7. Using the TRACK/SS Pin for Tracking

set by the resistor divider:

$$\frac{V_X}{V_{OUT}} = \frac{R_A}{R_{TRACKA}} \cdot \frac{R_{TRACKA} + R_{TRACKB}}{R_A + R_B}$$

For coincident tracking ($V_{OUT} = V_X$ during start-up),

$$R_A = R_{TRACKA}$$

$$R_B = R_{TRACKB}$$

INTV_{CC} Regulators

The LTC3827 features two separate internal P-channel low dropout linear regulators (LDO) that supply power at the INTV_{CC} pin from either the V_{IN} supply pin or the EXT_V_{CC} pin, respectively, depending on the connection of the EXT_V_{CC} pin. INTV_{CC} powers the gate drivers and much of the LTC3827's internal circuitry. The V_{IN} LDO regulates the voltage at the INTV_{CC} pin to 5.25V and the EXT_V_{CC} LDO regulates it to 7.5V. Each of these can supply a peak current of 50mA and must be bypassed to ground with a minimum of 4.7μF tantalum, 10μF special polymer, or low ESR electrolytic capacitor. A ceramic capacitor with a minimum value of 4.7μF can also be used if a 1Ω resistor is added in series with the capacitor. No matter what type of bulk capacitor is used, an additional 1μF ceramic capacitor placed directly adjacent to the INTV_{CC} and PGND IC pins is highly recommended. Good bypassing is needed to supply the high transient currents required by the MOSFET gate drivers and to prevent interaction between the channels.

High input voltage applications in which large MOSFETs are being driven at high frequencies may cause the maximum junction temperature rating for the LTC3827 to be exceeded. The INTV_{CC} current, which is dominated by the

APPLICATIONS INFORMATION

gate charge current, may be supplied by either the 5.25V V_{IN} LDO or the 7.5V $EXTV_{CC}$ LDO. When the voltage on the $EXTV_{CC}$ pin is less than 4.7V, the V_{IN} LDO is enabled. Power dissipation for the IC in this case is highest and is equal to $V_{IN} \cdot I_{INTV_{CC}}$. The gate charge current is dependent on operating frequency as discussed in the Efficiency Considerations section. The junction temperature can be estimated by using the equations given in Note 2 of the Electrical Characteristics. For example, the LTC3827 $INTV_{CC}$ current is limited to less than 24mA from a 24V supply when in the G package and not using the $EXTV_{CC}$ supply:

$$T_J = 70^\circ\text{C} + (24\text{mA})(24\text{V})(95^\circ\text{C/W}) = 125^\circ\text{C}$$

To prevent the maximum junction temperature from being exceeded, the input supply current must be checked while operating in continuous conduction mode (PLLIN/MODE = $INTV_{CC}$) at maximum V_{IN} .

When the voltage applied to $EXTV_{CC}$ rises above 4.7V, the V_{IN} LDO is turned off and the $EXTV_{CC}$ LDO is enabled. The $EXTV_{CC}$ LDO remains on as long as the voltage applied to $EXTV_{CC}$ remains above 4.5V. The $EXTV_{CC}$ LDO attempts to regulate the $INTV_{CC}$ voltage to 7.5V, so while $EXTV_{CC}$ is less than 7.5V, the LDO is in dropout and the $INTV_{CC}$ voltage is approximately equal to $EXTV_{CC}$. When $EXTV_{CC}$ is greater than 7.5V up to an absolute maximum of 10V, $INTV_{CC}$ is regulated to 7.5V.

Using the $EXTV_{CC}$ LDO allows the MOSFET driver and control power to be derived from one of the LTC3827's switching regulator outputs ($4.7\text{V} \leq V_{OUT} \leq 10\text{V}$) during normal operation and from the V_{IN} LDO when the output is out of regulation (e.g., start-up, short-circuit). If more current is required through the $EXTV_{CC}$ LDO than is specified, an external Schottky diode can be added between the $EXTV_{CC}$ and $INTV_{CC}$ pins. Do not apply more than 10V to the $EXTV_{CC}$ pin and make sure that $EXTV_{CC} \leq V_{IN}$.

Significant efficiency and thermal gains can be realized by powering $INTV_{CC}$ from the output, since the V_{IN} current resulting from the driver and control currents will be scaled by a factor of (Duty Cycle)/(Switcher Efficiency). For 5V to 10V regulator outputs, this means connecting the $EXTV_{CC}$ pin directly to V_{OUT} . Tying the $EXTV_{CC}$ pin to a 5V

supply reduces the junction temperature in the previous example from 125°C to:

$$T_J = 70^\circ\text{C} + (24\text{mA})(5\text{V})(95^\circ\text{C/W}) = 81^\circ\text{C}$$

However, for 3.3V and other low voltage outputs, additional circuitry is required to derive $INTV_{CC}$ power from the output.

The following list summarizes the four possible connections for $EXTV_{CC}$:

1. $EXTV_{CC}$ Left Open (or Grounded). This will cause $INTV_{CC}$ to be powered from the internal 5.25V regulator resulting in an efficiency penalty of up to 10% at high input voltages.
2. $EXTV_{CC}$ Connected directly to V_{OUT} . This is the normal connection for a 5V to 10V regulator and provides the highest efficiency.
3. $EXTV_{CC}$ Connected to an External supply. If an external supply is available in the 5V to 10V range, it may be used to power $EXTV_{CC}$ providing it is compatible with the MOSFET gate drive requirements.
4. $EXTV_{CC}$ Connected to an Output-Derived Boost Network. For 3.3V and other low voltage regulators, efficiency gains can still be realized by connecting $EXTV_{CC}$ to an output-derived voltage that has been boosted to greater than 4.7V. This can be done with the capacitive charge pump shown in Figure 8.

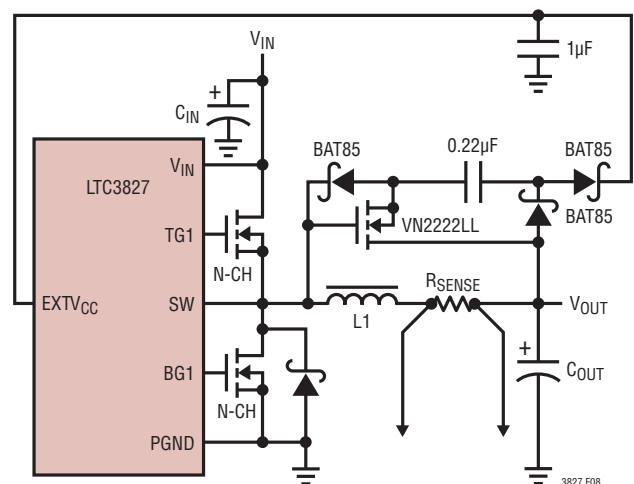

Figure 8. Capacitive Charge Pump for $EXTV_{CC}$

APPLICATIONS INFORMATION

Topside MOSFET Driver Supply (C_B , D_B)

External bootstrap capacitors, C_B , connected to the BOOST pins supply the gate drive voltages for the topside MOSFETs. Capacitor C_B in the Functional Diagram is charged through external diode D_B from $INTV_{CC}$ when the SW pin is low. When one of the topside MOSFETs is to be turned on, the driver places the C_B voltage across the gate-source of the desired MOSFET. This enhances the MOSFET and turns on the topside switch. The switch node voltage, SW, rises to V_{IN} and the BOOST pin follows. With the topside MOSFET on, the boost voltage is above the input supply: $V_{BOOST} = V_{IN} + V_{INTV_{CC}}$. The value of the boost capacitor, C_B , needs to be 100 times that of the total input capacitance of the topside MOSFET(s). The reverse breakdown of the external Schottky diode must be greater than $V_{IN(MAX)}$. When adjusting the gate drive level, the final arbiter is the total input current for the regulator. If a change is made and the input current decreases, then the efficiency has improved. If there is no change in input current, then there is no change in efficiency.

Fault Conditions: Current Limit and Current Foldback

The LTC3827 includes current foldback to help limit load current when the output is shorted to ground. If the output falls below 70% of its nominal output level, then the maximum sense voltage is progressively lowered from 100mV to 30mV. Under short-circuit conditions with very low duty cycles, the LTC3827 will begin cycle skipping in order to limit the short-circuit current. In this situation the bottom MOSFET will be dissipating most of the power but less than in normal operation. The short-circuit ripple current is determined by the minimum on-time, $t_{ON(MIN)}$, of the LTC3827 (≈ 180 ns), the input voltage and inductor value:

$$\Delta I_{L(SC)} = t_{ON(MIN)} (V_{IN}/L)$$

The resulting short-circuit current is:

$$I_{SC} = \frac{30mV}{R_{SENSE}} - \frac{1}{2} \Delta I_{L(SC)}$$

Fault Conditions: Overvoltage Protection (Crowbar)

The overvoltage crowbar is designed to blow a system input fuse when the output voltage of the regulator rises much higher than nominal levels. The crowbar causes huge currents to flow, that blow the fuse to protect against a shorted top MOSFET if the short occurs while the controller is operating.

A comparator monitors the output for overvoltage conditions. The comparator (OV) detects overvoltage faults greater than 10% above the nominal output voltage. When this condition is sensed, the top MOSFET is turned off and the bottom MOSFET is turned on until the overvoltage condition is cleared. The bottom MOSFET remains on continuously for as long as the OV condition persists; if V_{OUT} returns to a safe level, normal operation automatically resumes. A shorted top MOSFET will result in a high current condition which will open the system fuse. The switching regulator will regulate properly with a leaky top MOSFET by altering the duty cycle to accommodate the leakage.

Phase-Locked Loop and Frequency Synchronization

The LTC3827 has a phase-locked loop (PLL) comprised of an internal voltage-controlled oscillator (VCO) and a phase detector. This allows the turn-on of the top MOSFET of controller 1 to be locked to the rising edge of an external clock signal applied to the PLLIN/MODE pin. The turn-on of controller 2's top MOSFET is thus 180 degrees out of phase with the external clock. The phase detector is an edge sensitive digital type that provides zero degrees phase shift between the external and internal oscillators. This type of phase detector does not exhibit false lock to harmonics of the external clock.

The output of the phase detector is a pair of complementary current sources that charge or discharge the external filter network connected to the PLLLPF pin. The relationship between the voltage on the PLLLPF pin and operating frequency, when there is a clock signal applied

APPLICATIONS INFORMATION

to PLLIN/MODE, is shown in Figure 9 and specified in the Electrical Characteristics table. Note that the LTC3827 can only be synchronized to an external clock whose frequency is within range of the LTC3827's internal VCO, which is nominally 115kHz to 800kHz. This is guaranteed to be between 140kHz and 650kHz. A simplified block diagram is shown in Figure 10.

If the external clock frequency is greater than the internal oscillator's frequency, f_{OSC} , then current is sourced continuously from the phase detector output, pulling up the PLLLPF pin. When the external clock frequency is less than f_{OSC} , current is sunk continuously, pulling down the PLLLPF pin. If the external and internal frequencies are the same but exhibit a phase difference, the current sources turn on for an amount of time corresponding to the phase difference. The voltage on the PLLLPF pin is adjusted until the phase and frequency of the internal and external oscillators are identical. At the stable operating point, the phase detector output is high impedance and the filter capacitor, C_{LP} , holds the voltage.

The loop filter components, C_{LP} and R_{LP} , smooth out the current pulses from the phase detector and provide a stable input to the voltage-controlled oscillator. The filter components C_{LP} and R_{LP} determine how fast the loop

acquires lock. Typically $R_{LP} = 10k$ and C_{LP} is 2200pF to 0.01 μ F.

Typically, the external clock (on PLLIN/MODE pin) input high threshold is 1.6V, while the input low threshold is 1.2V.

Table 2 summarizes the different states in which the PLLLPF pin can be used.

Table 2

PLLLPF PIN	PLLIN/MODE PIN	FREQUENCY
0V	DC Voltage	250kHz
Floating	DC Voltage	400kHz
INTV _{CC}	DC Voltage	530kHz
RC Loop Filter	Clock Signal	Phase-Locked to External Clock

Minimum On-Time Considerations

Minimum on-time, $t_{ON(MIN)}$, is the smallest time duration that the LTC3827 is capable of turning on the top MOSFET. It is determined by internal timing delays and the gate charge required to turn on the top MOSFET. Low duty cycle applications may approach this minimum on-time limit and care should be taken to ensure that

$$t_{ON(MIN)} < \frac{V_{OUT}}{V_{IN}(f)}$$

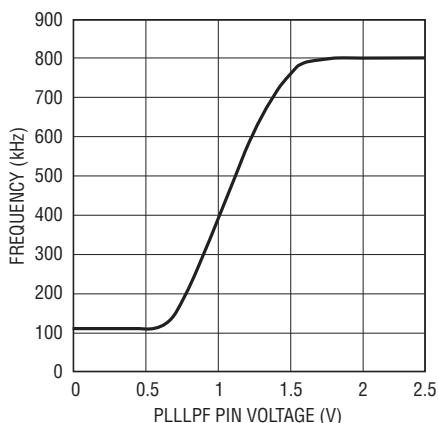

3827 F09

Figure 9. Relationship Between Oscillator Frequency and Voltage at the PLLLPF Pin When Synchronizing to an External Clock

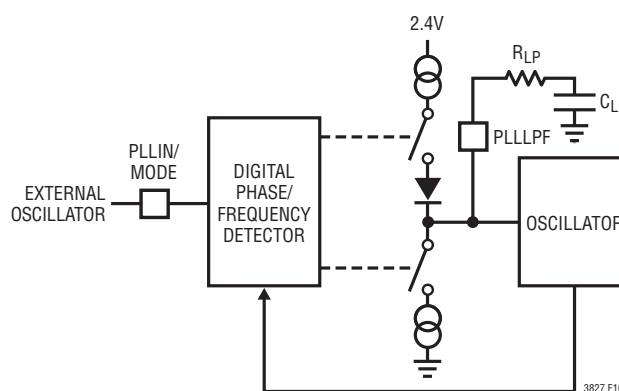

3827 F10

Figure 10. Phase-Locked Loop Block Diagram

APPLICATIONS INFORMATION

If the duty cycle falls below what can be accommodated by the minimum on-time, the controller will begin to skip cycles. The output voltage will continue to be regulated, but the ripple voltage and current will increase.

The minimum on-time for the LTC3827 is approximately 180ns. However, as the peak sense voltage decreases the minimum on-time gradually increases up to about 200ns. This is of particular concern in forced continuous applications with low ripple current at light loads. If the duty cycle drops below the minimum on-time limit in this situation, a significant amount of cycle skipping can occur with correspondingly larger current and voltage ripple.

Efficiency Considerations

The percent efficiency of a switching regulator is equal to the output power divided by the input power times 100%. It is often useful to analyze individual losses to determine what is limiting the efficiency and which change would produce the most improvement. Percent efficiency can be expressed as:

$$\% \text{Efficiency} = 100\% - (L1 + L2 + L3 + \dots)$$

where L1, L2, etc. are the individual losses as a percentage of input power.

Although all dissipative elements in the circuit produce losses, four main sources usually account for most of the losses in LTC3827 circuits: 1) IC V_{IN} current, 2) $INTV_{CC}$ regulator current, 3) I^2R losses, 4) Topside MOSFET transition losses.

1. The V_{IN} current has two components: the first is the DC supply current given in the Electrical Characteristics table, which excludes MOSFET driver and control currents; the second is the current drawn from the 3.3V linear regulator output. V_{IN} current typically results in a small (<0.1%) loss.
2. $INTV_{CC}$ current is the sum of the MOSFET driver and control currents. The MOSFET driver current results from switching the gate capacitance of the power

MOSFETs. Each time a MOSFET gate is switched from low to high to low again, a packet of charge dQ moves from $INTV_{CC}$ to ground. The resulting dQ/dt is a current out of $INTV_{CC}$ that is typically much larger than the control circuit current. In continuous mode, $I_{GATECHG} = f(Q_T + Q_B)$, where Q_T and Q_B are the gate charges of the topside and bottom side MOSFETs.

Supplying $INTV_{CC}$ power through the $EXTV_{CC}$ switch input from an output-derived source will scale the V_{IN} current required for the driver and control circuits by a factor of (Duty Cycle)/(Efficiency). For example, in a 20V to 5V application, 10mA of $INTV_{CC}$ current results in approximately 2.5mA of V_{IN} current. This reduces the mid-current loss from 10% or more (if the driver was powered directly from V_{IN}) to only a few percent.

3. I^2R losses are predicted from the DC resistances of the fuse (if used), MOSFET, inductor, current sense resistor, and input and output capacitor ESR. In continuous mode the average output current flows through L and R_{SENSE} , but is “chopped” between the topside MOSFET and the synchronous MOSFET. If the two MOSFETs have approximately the same $R_{DS(ON)}$, then the resistance of one MOSFET can simply be summed with the resistances of L, R_{SENSE} and ESR to obtain I^2R losses. For example, if each $R_{DS(ON)} = 30m\Omega$, $R_L = 50m\Omega$, $R_{SENSE} = 10m\Omega$ and $R_{ESR} = 40m\Omega$ (sum of both input and output capacitance losses), then the total resistance is 130m Ω . This results in losses ranging from 3% to 13% as the output current increases from 1A to 5A for a 5V output, or a 4% to 20% loss for a 3.3V output. Efficiency varies as the inverse square of V_{OUT} for the same external components and output power level. The combined effects of increasingly lower output voltages and higher currents required by high performance digital systems is not doubling but quadrupling the importance of loss terms in the switching regulator system!

APPLICATIONS INFORMATION

4. Transition losses apply only to the topside MOSFET(s), and become significant only when operating at high input voltages (typically 15V or greater). Transition losses can be estimated from:

$$\text{Transition Loss} = (1.7) V_{IN}^2 I_{O(\text{MAX})} C_{RSS} f$$

Other “hidden” losses such as copper trace and internal battery resistances can account for an additional 5% to 10% efficiency degradation in portable systems. It is very important to include these “system” level losses during the design phase. The internal battery and fuse resistance losses can be minimized by making sure that C_{IN} has adequate charge storage and very low ESR at the switching frequency. A 25W supply will typically require a minimum of 20 μ F to 40 μ F of capacitance having a maximum of 20m Ω to 50m Ω of ESR. The LTC3728L 2-phase architecture typically halves this input capacitance requirement over competing solutions. Other losses including Schottky conduction losses during dead-time and inductor core losses generally account for less than 2% total additional loss.

Checking Transient Response

The regulator loop response can be checked by looking at the load current transient response. Switching regulators take several cycles to respond to a step in DC (resistive) load current. When a load step occurs, V_{OUT} shifts by an amount equal to ΔI_{LOAD} (ESR), where ESR is the effective series resistance of C_{OUT} . ΔI_{LOAD} also begins to charge or discharge C_{OUT} generating the feedback error signal that forces the regulator to adapt to the current change and return V_{OUT} to its steady-state value. During this recovery time V_{OUT} can be monitored for excessive overshoot or ringing, which would indicate a stability problem. OPTI-LOOP compensation allows the transient response to be optimized over a wide range of output capacitance and ESR values. *The availability of the I_{TH} pin not only allows optimization of control loop behavior but also provides*

a DC coupled and AC filtered closed-loop response test point. The DC step, rise time and settling at this test point truly reflects the closed-loop response. Assuming a predominantly second order system, phase margin and/or damping factor can be estimated using the percentage of overshoot seen at this pin. The bandwidth can also be estimated by examining the rise time at the pin. The I_{TH} external components shown in Figure 13 circuit will provide an adequate starting point for most applications.

The I_{TH} series R_C - C_C filter sets the dominant pole-zero loop compensation. The values can be modified slightly (from 0.5 to 2 times their suggested values) to optimize transient response once the final PC layout is done and the particular output capacitor type and value have been determined. The output capacitors need to be selected because the various types and values determine the loop gain and phase. An output current pulse of 20% to 80% of full-load current having a rise time of 1 μ s to 10 μ s will produce output voltage and I_{TH} pin waveforms that will give a sense of the overall loop stability without breaking the feedback loop. Placing a power MOSFET directly across the output capacitor and driving the gate with an appropriate signal generator is a practical way to produce a realistic load step condition. The initial output voltage step resulting from the step change in output current may not be within the bandwidth of the feedback loop, so this signal cannot be used to determine phase margin. This is why it is better to look at the I_{TH} pin signal which is in the feedback loop and is the filtered and compensated control loop response. The gain of the loop will be increased by increasing R_C and the bandwidth of the loop will be increased by decreasing C_C . If R_C is increased by the same factor that C_C is decreased, the zero frequency will be kept the same, thereby keeping the phase shift the same in the most critical frequency range of the feedback loop. The output voltage settling behavior is related to the