



Chipsmall Limited consists of a professional team with an average of over 10 year of expertise in the distribution of electronic components. Based in Hongkong, we have already established firm and mutual-benefit business relationships with customers from,Europe,America and south Asia,supplying obsolete and hard-to-find components to meet their specific needs.

With the principle of “Quality Parts,Customers Priority,Honest Operation,and Considerate Service”,our business mainly focus on the distribution of electronic components. Line cards we deal with include Microchip,ALPS,ROHM,Xilinx,Pulse,ON,Everlight and Freescale. Main products comprise IC,Modules,Potentiometer,IC Socket,Relay,Connector.Our parts cover such applications as commercial,industrial, and automotives areas.

We are looking forward to setting up business relationship with you and hope to provide you with the best service and solution. Let us make a better world for our industry!



## Contact us

Tel: +86-755-8981 8866 Fax: +86-755-8427 6832

Email & Skype: info@chipsmall.com Web: www.chipsmall.com

Address: A1208, Overseas Decoration Building, #122 Zhenhua RD., Futian, Shenzhen, China



# Bidirectional PolyPhase® Synchronous Buck or Boost Controller

## FEATURES

- Unique Architecture Allows Dynamic Regulation of Input Voltage, Output Voltage or Current
- $V_{HIGH}$  Voltages Up to 100V
- $V_{LOW}$  Voltages Up to 30V
- Synchronous Rectification: Up to 97% Efficiency
- LTC-Proprietary Advanced Current Mode Control
- $\pm 1\%$  Voltage Regulation Accuracy Over Temperature
- Accurate, Programmable Output Current Monitoring and Regulation for Both Buck and Boost Operation
- Selectable Buck and Boost Current Sense Limits
- Programmable  $DRV_{CC}/EXTV_{CC}$  Optimizes Efficiency
- Programmable  $V_{HIGH}$  UV and OV Thresholds
- Programmable  $V_{LOW}$  OV Threshold
- Phase-Lockable Frequency: 60kHz to 460kHz
- Multiphase/Multi-ICs Operation Up to 12 Phases
- Selectable CCM/DCM Modes
- Thermally Enhanced 48-Lead LQFP Package

## APPLICATIONS

- Automotive 48V/12V Dual Battery Systems
- Backup Power Systems

## DESCRIPTION

The **LTC®3871** is a high performance bidirectional buck or boost switching regulator controller that operates in either buck or boost mode on demand. It regulates in buck mode from  $V_{HIGH}$  to  $V_{LOW}$  and boost mode from  $V_{LOW}$  to  $V_{HIGH}$  depending on a control signal, making it ideal for 48V/12V automotive dual battery systems. An accurate current programming loop regulates the maximum current that can be delivered in either direction. The LTC3871 allows both batteries to supply energy to the load simultaneously by converting energy from one battery to the other.

Its proprietary constant-frequency current mode architecture enhances the signal-to-noise ratio enabling low noise operation and provides excellent current matching between phases. Additional features include discontinuous or continuous mode of operation, OV/UV monitors, independent loop compensation for buck and boost operation, accurate output current monitoring and overcurrent protection.

LT, LT, LTC, LTM, Linear Technology, the Linear logo,  $\mu$ Module, PolyPhase and OPTI-LOOP are registered trademarks of Linear Technology Corporation. All other trademarks are the property of their respective owners. Protected by U.S. Patents, including 5481178, 5705919, 5929620, 6177787, 6580258, 6100678, 6144154, 6304066.

## TYPICAL APPLICATION

High Efficiency Bidirectional Charger/Power Supply

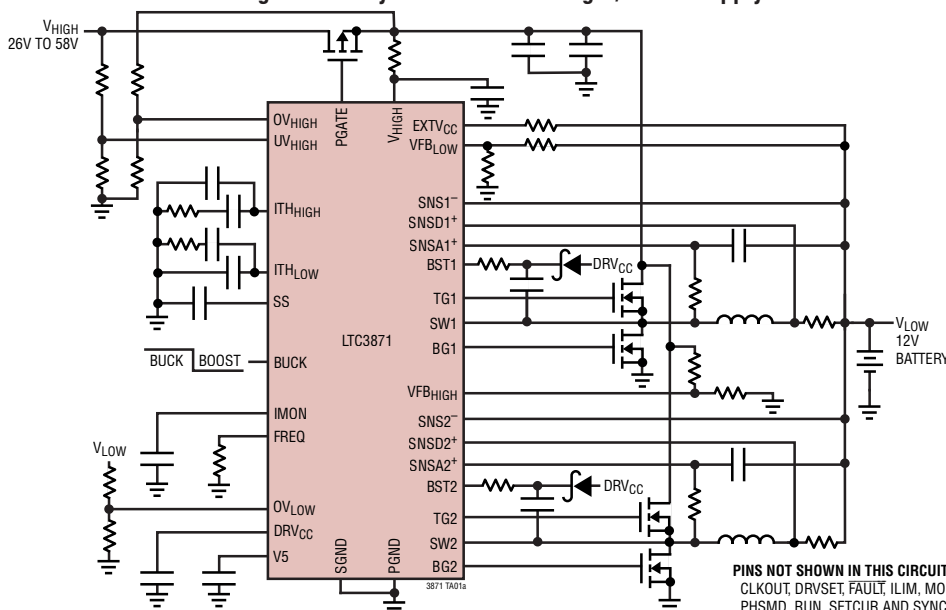

Buck-to-Boost Transition

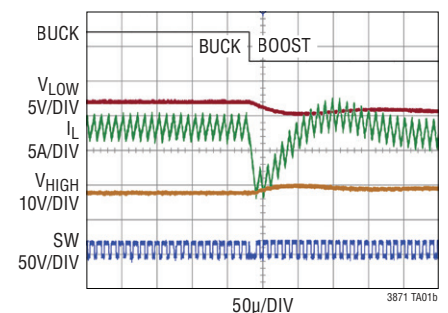

# LTC3871

## ABSOLUTE MAXIMUM RATINGS

(Note 1)

$V_{HIGH}$ .....	-0.3V to 100V
Top Side Driver Voltages (BOOST1, BOOST2) .....	-0.3V to 111V
Switch Voltage (SW1, SW2) .....	-5V to 100V
Current Sense Voltages (SNSA <sup>+</sup> , SNS <sup>-</sup> , SNSD <sup>+</sup> Channels 1 and 2)..	-0.3V to 34V
(BOOST1-SW1), (BOOST2-SW2) .....	-0.3V to 11V
EXTV <sub>CC</sub> .....	-0.3V to 34V
DRV <sub>CC</sub> .....	-0.3V to 11V
VFB <sub>HIGH</sub> , VFB <sub>LOW</sub> .....	-0.3V to V5
MODE, SS Voltages.....	-0.3V to V5
RUN .....	-0.3V to 6V
FAULT, SETCUR, Voltages .....	-0.3V to V5
ILIM, DRVSET, BUCK Voltages .....	-0.3V to V5
OV <sub>HIGH</sub> , UV <sub>HIGH</sub> , OV <sub>LOW</sub> Voltages .....	-0.3V to 6V
SYNC, PHSMD Voltages .....	-0.3V to V5
Operating Junction Temperature Range (Notes 2, 3).....	-40°C to 150°C
Storage Temperature Range .....	-65°C to 150°C
DRV <sub>CC</sub> /EXTV <sub>CC</sub> Peak Current.....	100mA

## PIN CONFIGURATION

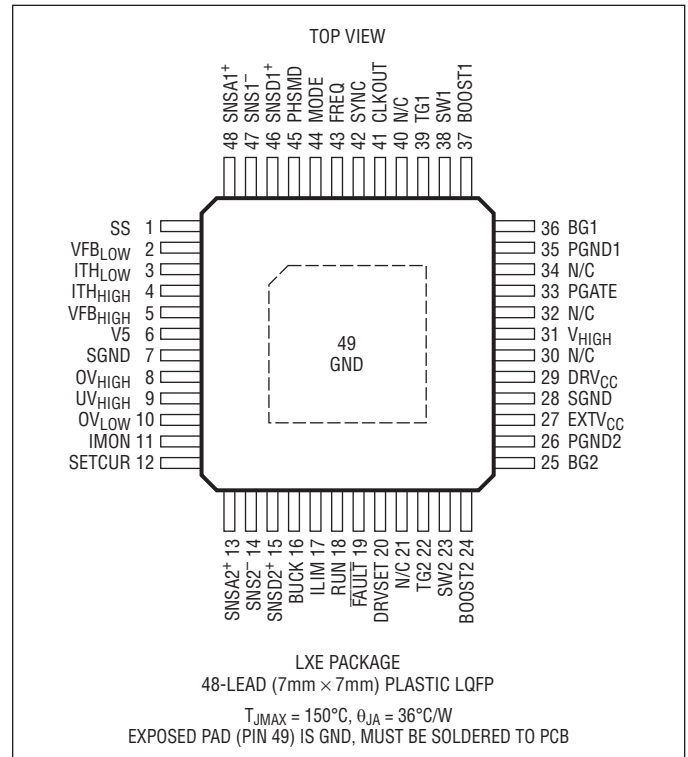

## ORDER INFORMATION

(<http://www.linear.com/product/LTC3871#orderinfo>)

LEAD FREE FINISH	PART MARKING*	PACKAGE DESCRIPTION	TEMPERATURE RANGE
LTC3871ELXE#PBF	LTC3871	48-Lead (7mm × 7mm) Plastic LQFP	-40°C to 125°C
LTC3871ILXE#PBF	LTC3871	48-Lead (7mm × 7mm) Plastic LQFP	-40°C to 125°C
LTC3871HLXE#PBF	LTC3871	48-Lead (7mm × 7mm) Plastic LQFP	-40°C to 150°C

Consult LTC Marketing for parts specified with wider operating temperature ranges. \*The temperature grade is identified by a label on the shipping container. For more information on lead free part marking, go to: <http://www.linear.com/leadfree/>

## ELECTRICAL CHARACTERISTICS

The ● denotes the specifications which apply over the specified operating junction temperature range, otherwise specifications are at  $T_A = 25^\circ\text{C}$ ,  $V_{\text{HIGH}} = 50\text{V}$ ,  $V_{\text{RUN}} = 5\text{V}$  unless otherwise noted (Note 2).

SYMBOL	PARAMETER	CONDITIONS	MIN	TYP	MAX	UNITS
$V_{\text{HIGH}}$	$V_{\text{HIGH}}$ Supply Voltage Range		5		100	V
$V_{\text{LOW}}$	$V_{\text{LOW}}$ Supply Voltage Range	$V_{\text{HIGH}} > 5\text{V}$	1.2		30	V
	$V_{\text{LOW}}$ Regulated Feedback Voltage	(Note 4); $I_{\text{TH}_{\text{LOW}}}$ Voltage = 1.5V ●	1.188	1.200	1.212	V
	$V_{\text{HIGH}}$ Regulated Feedback Voltage	(Note 4); $I_{\text{TH}_{\text{HIGH}}}$ Voltage = 0.5V ●	1.185	1.200	1.215	V
	$V_{\text{LOW}}$ EA Feedback Current	(Note 4)		-115	-200	nA
	$V_{\text{HIGH}}$ EA Feedback Current	(Note 4)		-115	-200	nA
	Reference Voltage Line Regulation	(Note 4); $V_{\text{HIGH}} = 7\text{V}$ to 80V		0.02	0.2	%
	$V_{\text{LOW}}/V_{\text{HIGH}}$ Voltage Load Regulation	Measured in Servo Loop; $\Delta I_{\text{TH}}$ Voltage = 1V to 1.5V		0.01	0.2	%
		Measured in Servo Loop; $\Delta I_{\text{TH}}$ Voltage = 1V to 0.5V		-0.01	-0.2	%
$g_{\text{m-buck}}$	Transconductance Amplifier $g_{\text{m-buck}}$	(Note 4); $I_{\text{TH}_{\text{LOW}}} = 1.5\text{V}$ ; Sink/Source 5 $\mu\text{A}$		2		mmho
$g_{\text{m-boost}}$	Transconductance Amplifier $g_{\text{m-boost}}$	(Note 4); $I_{\text{TH}_{\text{HIGH}}} = 0.5\text{V}$ ; Sink/Source 5 $\mu\text{A}$		1		mmho
$I_{\text{Q}}$	$V_{\text{HIGH}}$ DC Supply Current	(Note 5)		8	14	mA
	Shutdown ( $V_{\text{HIGH}}$ )	$V_{\text{RUN}} = 0\text{V}$ ; $V_{\text{HIGH}} = 50\text{V}$		140		$\mu\text{A}$
	Undervoltage Lockout	V5 Ramping Down	3.7	4.15	4.5	V
	Undervoltage Hysteresis			0.5		V
	RUN Pin On Threshold	$V_{\text{RUN}}$ Rising	1.1	1.22	1.35	V
	RUN Pin On Hysteresis			80		mV
	RUN Pin Source Current	$V_{\text{RUN}} < 1.2$ ●	1	2		$\mu\text{A}$
	RUN Pin Source Current	$V_{\text{RUN}} > 1.3$ ●	3	6.5		$\mu\text{A}$
$I_{\text{SS}}$	Soft-Start Charging Current	$V_{\text{SS}} = 1.2\text{V}$	0.9	1.25	1.7	$\mu\text{A}$
$I_{\text{SNSA}+1,2}$	Current Sensing Pins Current			0.1	$\pm 1$	$\mu\text{A}$
$I_{\text{SNSD}+1,2}$	Current Sensing Pins Current			0.01	$\pm 1$	$\mu\text{A}$
$I_{\text{SNS}^-1,2}$	Current Sensing Pins Current			1.5		mA
	Total DC Sense Signal Gain	DCR Configuration		5		V/V
	ILIM Pin Input Resistance			100		k $\Omega$
$I_{\text{SETCUR}}$	Current to Program Initial Current Limit		6.75	7.5	8.25	$\mu\text{A}$
	IMON Current Proportional to $V_{\text{LOW}}$ at Max Current	$V_{\text{ILIM}} = \text{Float}$ ; $R_{\text{SENSE}} = 3\text{m}\Omega$			$\pm 10$	%
	IMON Zero Current Voltage		1.225	1.25	1.275	V
	Sense Pin to IMON Gain	$V_{\text{ILIM}} = 0\text{V}$ , 1/4 $V_{\text{V5}}$ , Float		38		V/V
		$V_{\text{ILIM}} = 3/4 V_{\text{V5}}$ , $V_{\text{V5}}$		19		V/V
	TG Pull-Up On-Resistance			5		$\Omega$
	TG Pull-Down On-Resistance			2.5		$\Omega$
	BG Driver Pull-Up On-Resistance			5		$\Omega$
	BG Driver Pull-Down On-Resistance			2.5		$\Omega$
	Total DC Sense Signal Gain	$R_{\text{SENSE}}$ Configuration		4		V/V
	Maximum Duty Cycle	Buck Mode	96	98		%
		Boost Mode			92	%

## ELECTRICAL CHARACTERISTICS

The ● denotes the specifications which apply over the specified operating junction temperature range, otherwise specifications are at  $T_A = 25^\circ\text{C}$ ,  $V_{\text{HIGH}} = 50\text{V}$ ,  $V_{\text{RUN}} = 5\text{V}$  unless otherwise noted (Note 2).

SYMBOL	PARAMETER	CONDITIONS	MIN	TYP	MAX	UNITS
$V_{\text{SENSE(MAX)}}$ (DCR Sensing)	Maximum Current Sense Threshold (Buck and Boost Mode)	$0^\circ\text{C}$ to $150^\circ\text{C}$ $V_{\text{ILIM}} = 0\text{V}$	● 8	10	14.5	mV
		$V_{\text{ILIM}} = 1/4 V_{\text{V5}}$	● 17	20	24	mV
		$V_{\text{ILIM}} = \text{Float}$	● 26.5	30	33.5	mV
		$V_{\text{ILIM}} = 3/4 V_{\text{V5}}$	● 36	40	44.5	mV
		$V_{\text{ILIM}} = V_{\text{V5}}$	● 44.5	50	55.5	mV
$V_{\text{SENSE(MAX)}}$ ( $R_{\text{SENSE}}$ Sensing)	Maximum Current Sense Threshold (Buck and Boost Mode)	$0^\circ\text{C}$ to $150^\circ\text{C}$ $V_{\text{ILIM}} = 0\text{V}$	● 10	12.5	18.2	mV
		$V_{\text{ILIM}} = 1/4 V_{\text{V5}}$	● 21.3	25	30	mV
		$V_{\text{ILIM}} = \text{Float}$	● 33.2	37.5	41.9	mV
		$V_{\text{ILIM}} = 3/4 V_{\text{V5}}$	● 45	50	55.6	mV
		$V_{\text{ILIM}} = V_{\text{V5}}$	● 55.6	62.5	69.4	mV
$V_{\text{SENSE(MAX)}}$ (DCR Sensing)	Maximum Current Sense Threshold (Buck and Boost Mode)	$-40^\circ\text{C}$ to $150^\circ\text{C}$ $V_{\text{ILIM}} = 0\text{V}$	● 7	10	14.5	mV
		$V_{\text{ILIM}} = 1/4 V_{\text{V5}}$	● 16	20	24	mV
		$V_{\text{ILIM}} = \text{Float}$	● 26	30	33.5	mV
		$V_{\text{ILIM}} = 3/4 V_{\text{V5}}$	● 35	40	44.5	mV
		$V_{\text{ILIM}} = V_{\text{V5}}$	● 42	50	55.5	mV
$V_{\text{SENSE(MAX)}}$ ( $R_{\text{SENSE}}$ Sensing)	Maximum Current Sense Threshold (Buck and Boost Mode)	$-40^\circ\text{C}$ to $150^\circ\text{C}$ $V_{\text{ILIM}} = 0\text{V}$	● 8.8	12.5	18.2	mV
		$V_{\text{ILIM}} = 1/4 V_{\text{V5}}$	● 20	25	30	mV
		$V_{\text{ILIM}} = \text{Float}$	● 32.5	37.5	41.9	mV
		$V_{\text{ILIM}} = 3/4 V_{\text{V5}}$	● 43.8	50	55.6	mV
		$V_{\text{ILIM}} = V_{\text{V5}}$	● 52.5	62.5	69.4	mV
TG $t_r$	Top Gate Rise Time	(Note 6)		60		ns
TG $t_f$	Top Gate Fall Time					
BG $t_r$	Bottom Gate Rise Time	(Note 6)		60		ns
BG $t_f$	Bottom Gate Fall Time					
	Top Gate Off to Bottom Gate On Delay Synchronous Switch-On Delay Time	(Note 6) $C_{\text{LOAD}} = 3300\text{pF}$ Each Driver		60		ns
	Bottom Gate Off to Top Gate On Delay Top Switch-On Delay Time	(Note 6) $C_{\text{LOAD}} = 3300\text{pF}$ Each Driver		60		ns
	V5 Regulation Voltage	$6\text{V} < V_{\text{DRVCC}} < 10\text{V}$	5.3	5.5	5.7	V
	V5 Load Regulation	$I_{\text{V5}} = 0\text{mA}$ to $20\text{mA}$		0.5	1	%
$V_{\text{DRVCC}}$	DRV <sub>CC</sub> Regulation Voltage	$12\text{V} < V_{\text{EXTVCC}} < 30\text{V}$ , $V_{\text{DRVSET}} = V_{\text{V5}}$	9.5	10	10.5	V
		$12\text{V} < V_{\text{EXTVCC}} < 30\text{V}$ , $V_{\text{DRVSET}} = 3/4 V_{\text{V5}}$	8.5	9	9.5	V
		$12\text{V} < V_{\text{EXTVCC}} < 30\text{V}$ , $V_{\text{DRVSET}} = \text{Float}$	7.5	8	8.5	V
		$12\text{V} < V_{\text{EXTVCC}} < 30\text{V}$ , $V_{\text{DRVSET}} = 1/4 V_{\text{V5}}$	6.5	7	7.5	V
		$12\text{V} < V_{\text{EXTVCC}} < 30\text{V}$ , $V_{\text{DRVSET}} = 0\text{V}$	5.5	6	6.5	V
	DRV <sub>CC</sub> Load Regulation	$I_{\text{CC}} = 0\text{mA}$ to $20\text{mA}$ , $V_{\text{EXTVCC}} = 10\text{V}$		0.2	1	%
$V_{\text{EXTVCC}}$	EXTV <sub>CC</sub> Switchover Voltage	EXTV <sub>CC</sub> Ramping Positive		DRV <sub>CC</sub> -0.5V		V
	EXTV <sub>CC</sub> Hysteresis			10		%
CLKOUT Phasing	Phase Relative to Channel 1	$V_{\text{PHSMD}} = 0\text{V}$		60		Deg
		$V_{\text{PHSMD}} = 1/4 V_{\text{V5}}$		60		Deg
		$V_{\text{PHSMD}} = \text{Float}$		90		Deg
		$V_{\text{PHSMD}} = 3/4 V_{\text{V5}}$		45		Deg
		$V_{\text{PHSMD}} = V_{\text{V5}}$		240		Deg

## ELECTRICAL CHARACTERISTICS

The ● denotes the specifications which apply over the specified operating junction temperature range, otherwise specifications are at  $T_A = 25^\circ\text{C}$ ,  $V_{\text{HIGH}} = 50\text{V}$ ,  $V_{\text{RUN}} = 5\text{V}$  unless otherwise noted (Note 2).

SYMBOL	PARAMETER	CONDITIONS	MIN	TYP	MAX	UNITS
SYNC Phasing	Phase Relative to Channel 1	$V_{\text{PHSMD}} = 0\text{V}$		0		Deg
		$V_{\text{PHSMD}} = 1/4 V_{\text{V5}}$		90		Deg
		$V_{\text{PHSMD}} = \text{Float}$		0		Deg
		$V_{\text{PHSMD}} = 3/4 V_{\text{V5}}$		0		Deg
		$V_{\text{PHSMD}} = V_{\text{V5}}$		0		Deg
Channel to Channel Phasing	Channel 1 to Channel 2	$V_{\text{PHSMD}} = 0\text{V}$		180		Deg
		$V_{\text{PHSMD}} = 1/4 V_{\text{V5}}$		180		Deg
		$V_{\text{PHSMD}} = \text{Float}$		180		Deg
		$V_{\text{PHSMD}} = 3/4 V_{\text{V5}}$		180		Deg
		$V_{\text{PHSMD}} = V_{\text{V5}}$		120		Deg
$\text{CLKOUT}_{\text{HI}}$	Clock Output High Voltage	$I_{\text{LOAD}} = 0.5\text{mA}$	5.2	5.5		V
$\text{CLKOUT}_{\text{LO}}$	Clock Output Low Voltage	$I_{\text{LOAD}} = -0.5\text{mA}$		0	0.2	V
$V_{\text{SYNC}}$	Sync Input Threshold	$V_{\text{SYNC}}$ Rising	2			V
		$V_{\text{SYNC}}$ Falling			1.2	V
	Nominal Frequency	$R_{\text{FREQ}} = 51.1\text{k}\Omega$	180	200	220	kHz
$f_{\text{LOW}}$	Low Fixed Frequency	$R_{\text{FREQ}} = \leq 20\text{k}\Omega$	40	50	60	kHz
$f_{\text{HIGH}}$	High Fixed Frequency	$R_{\text{FREQ}} = 117\text{k}\Omega$	450	500	550	kHz
	Synchronizable Frequency	SYNC = External Clock ●	60		460	kHz
	SYNC Input Resistance			100		k $\Omega$
$I_{\text{FREQ}}$	Frequency Setting Current		18 ●	20	22	$\mu\text{A}$
	$\overline{\text{FAULT}}$ Voltage Low	$I_{\text{FAULT}} = 2\text{mA}$		0.1	0.3	V
	$\overline{\text{FAULT}}$ Leakage Current	$V_{\text{FAULT}} = 5.5\text{V}$			$\pm 1$	$\mu\text{A}$
	$\overline{\text{FAULT}}$ Delay	Going Low		125		$\mu\text{s}$
	$V_{\text{LOW}}$ OV Comparator Threshold		1.15	1.2	1.25	V
	$V_{\text{LOW}}$ OV Comparator Hysteresis	$V_{\text{OVLOW}} > 1.2\text{V}$		5		$\mu\text{A}$
	$V_{\text{HIGH}}$ OV Comparator Threshold		1.15	1.2	1.25	V
	$V_{\text{HIGH}}$ OV Comparator Hysteresis	$V_{\text{OVHIGH}} > 1.2\text{V}$		5		$\mu\text{A}$
	$V_{\text{HIGH}}$ UV Comparator Threshold		1.15	1.2	1.25	V
	$V_{\text{HIGH}}$ UV Comparator Hysteresis	$V_{\text{UVHIGH}} < 1.2\text{V}$		5		$\mu\text{A}$
	BUCK Pin Pull-Up Resistance	BUCK Pin to V5		200		k $\Omega$

**Note 1:** Stresses beyond those listed under Absolute Maximum Ratings may cause permanent damage to the device. Exposure to any Absolute Maximum Ratings for extended periods may affect device reliability and lifetime.

**Note 2:** The LTC3871 is tested under pulsed load conditions such that  $T_J \approx T_A$ . The LTC3871E is guaranteed to meet performance specifications from  $0^\circ\text{C}$  to  $85^\circ\text{C}$  junction temperature. Specifications over the  $-40^\circ\text{C}$  to  $125^\circ\text{C}$  operating junction temperature range are assured by design, characterization and correlation with statistical process controls. The LTC3875I is guaranteed over the  $-40^\circ\text{C}$  to  $125^\circ\text{C}$  operating junction temperature range. The LTC3871H is guaranteed over the full  $-40^\circ\text{C}$  to  $150^\circ\text{C}$  operating junction temperature range. High junction temperature degrades operating lifetimes; operating lifetime is derated for junction temperatures greater than  $125^\circ\text{C}$ . Note that the maximum ambient

temperature consistent with these specifications is determined by specific operating conditions in conjunction with board layout, the rated package thermal impedance and other environmental factors.

**Note 3:**  $T_J$  is calculated from the ambient temperature  $T_A$  and power dissipation  $P_D$  according to the following formula:  $T_J = T_A + (P_D \cdot 36^\circ\text{C}/\text{W})$ .

**Note 4:** The LTC3871 is tested in a feedback loop that servos  $V_{\text{ITHIGH}}$  and  $V_{\text{ITHLow}}$  to a specified voltage and measures the resultant  $V_{\text{FBHIGH}}$  and  $V_{\text{FBLow}}$ , respectively.

**Note 5:** Dynamic supply current is higher due to the gate charge being delivered at the switching frequency. See Applications information.

**Note 6:** Rise and fall times are measured using 10% and 90% levels. Delay times are measured using 50% levels.

## TYPICAL PERFORMANCE CHARACTERISTICS

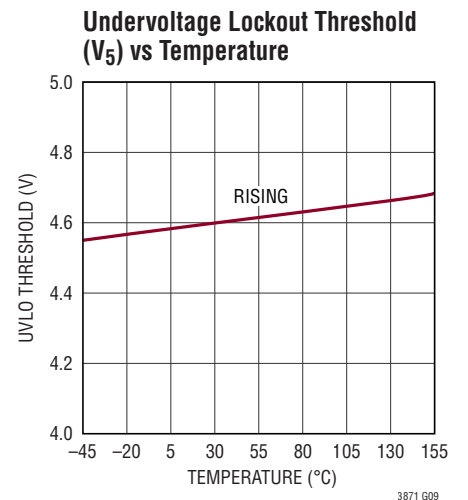
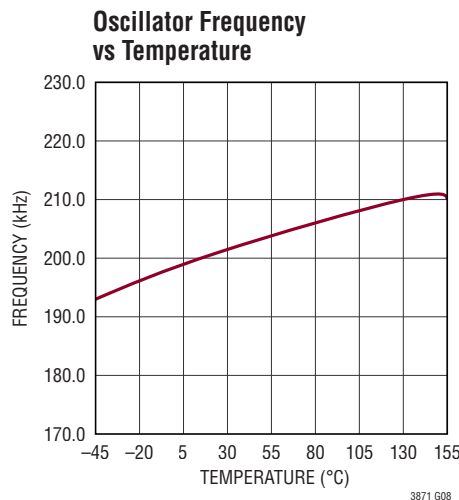
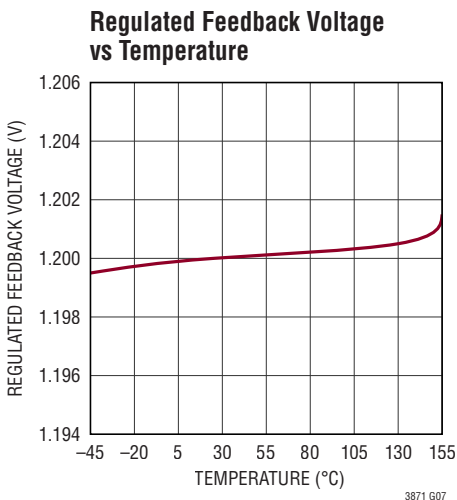
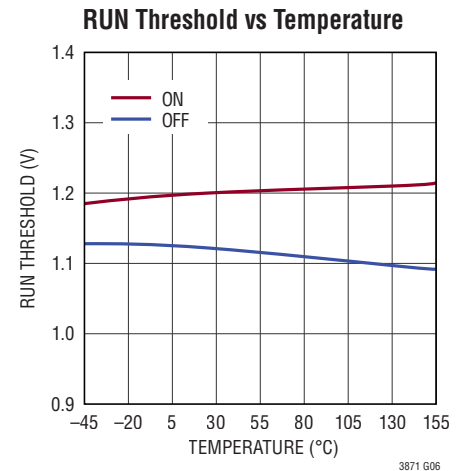
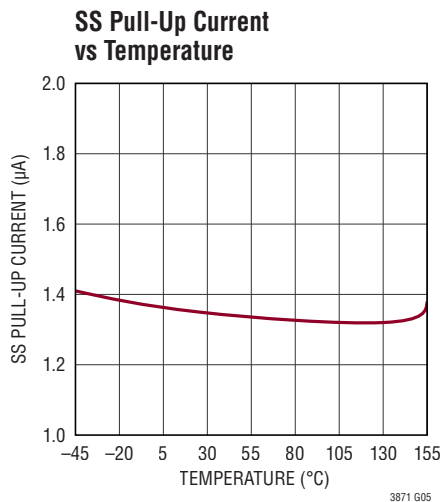
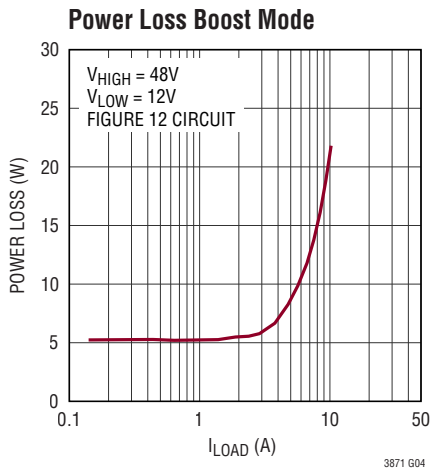
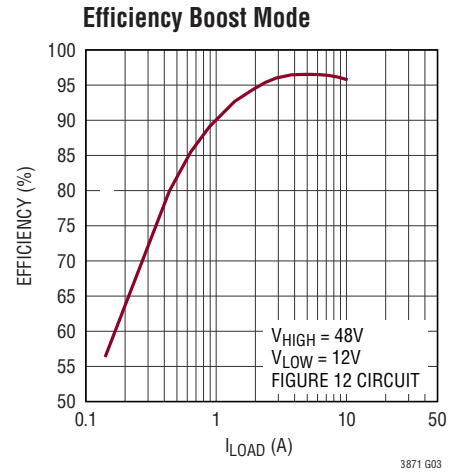
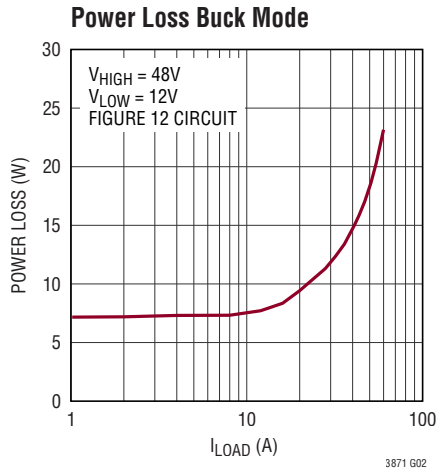
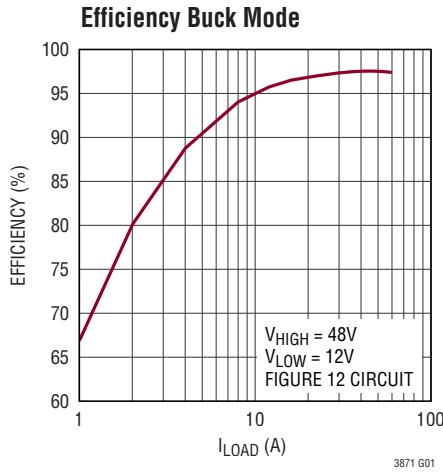

# TYPICAL PERFORMANCE CHARACTERISTICS

**Quiescent Current vs Temperature**

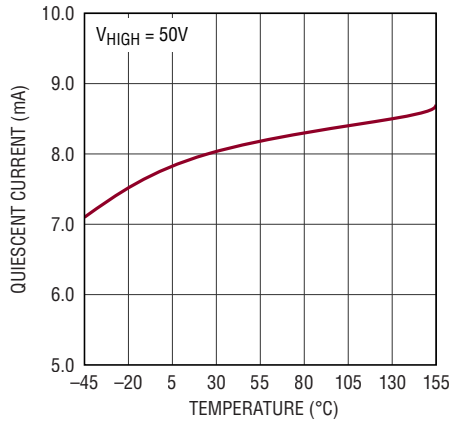

**Shutdown Current vs Temperature**

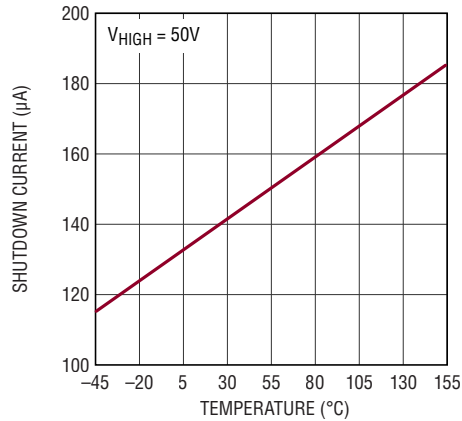

**FREQ Pin Source Current vs Temperature**

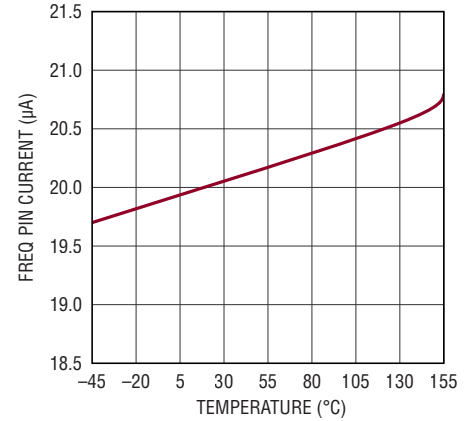

**Current Sense Threshold vs ITH Voltage (DCR)**

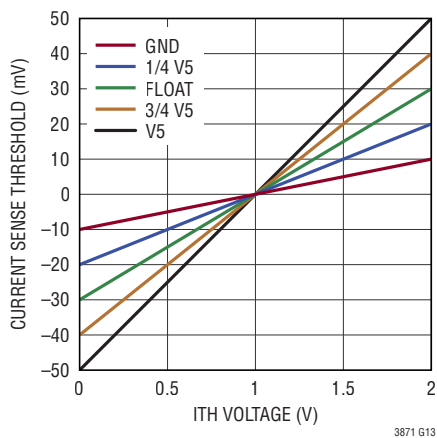

**Maximum Current Sense Threshold vs Duty Cycle – BUCK (DCR)**

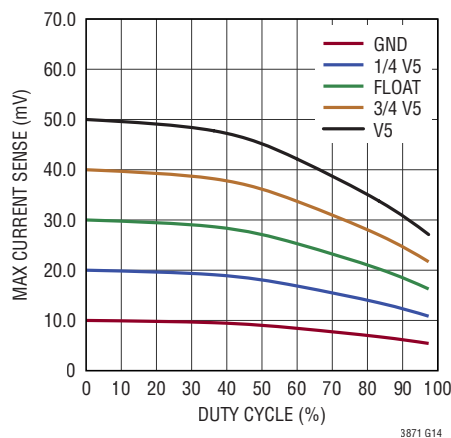

**Maximum Current Sense Threshold vs Feedback Voltage (DCR)**

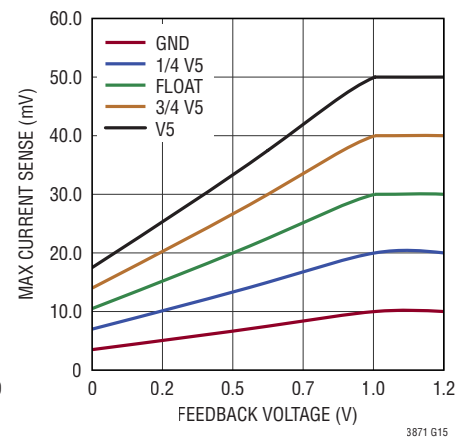

**Current Sense Threshold vs ITH Voltage (RSENSE)**

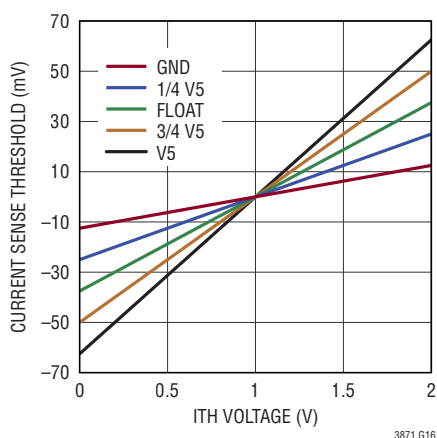

**Maximum Current Sense Threshold vs Duty Cycle – BUCK (RSENSE)**

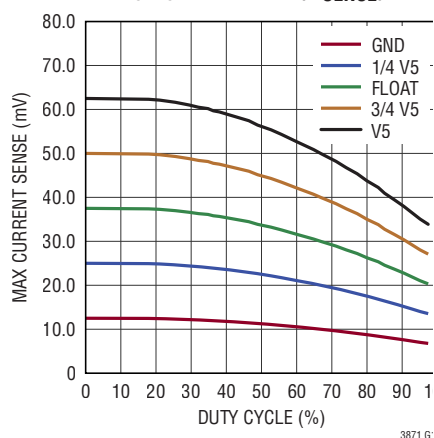

**Maximum Current Sense Threshold vs Feedback Voltage (RSENSE)**

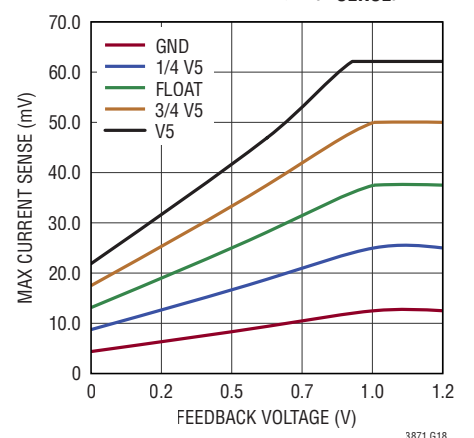



## PIN FUNCTIONS

**SS (Pin 1):** Soft-Start Input. The voltage ramp rate at this pin sets the voltage ramp rate of the regulated voltage. A capacitor to ground accomplishes soft-start in buck mode. This pin has a 1.25 $\mu$ A pull-up current.

**VFB<sub>LOW</sub> (Pin 2):** V<sub>LOW</sub> Voltage Sensing Error Amplifier Inverting Input.

**ITH<sub>LOW</sub>/ITH<sub>HIGH</sub> (Pins 3 and 4):** Current Control Threshold and Error Amplifier Compensation Point. The current comparator's threshold varies with the ITH control voltage.

**VFB<sub>HIGH</sub> (Pin 5):** V<sub>HIGH</sub> Voltage Sensing Error Amplifier Inverting Input.

**V5 (Pin 6):** Internal 5.5V Regulator Output. The control circuits are powered from this voltage. Bypass this pin to SGND with a minimum of 4.7 $\mu$ F low ESR tantalum or ceramic capacitor.

**SGND (Pins 7 and 28):** Signal Ground Pins.

**OV<sub>HIGH</sub> (Pin 8):** V<sub>HIGH</sub> Overvoltage Threshold Set Pin. A resistor divider from V<sub>HIGH</sub> is needed to set this threshold. When the voltage on this pin rises past the 1.2V trip point, a 5 $\mu$ A current is sourced out of the pin to provide externally adjustable hysteresis. When OV<sub>HIGH</sub> voltage is above 3V, the controller stops switching.

**UV<sub>HIGH</sub> (Pin 9):** V<sub>HIGH</sub> Undervoltage Threshold Set Pin. A resistor divider from V<sub>HIGH</sub> is needed to set this threshold. This pin also controls the state of the PGATE pin. When the voltage on this pin falls below the 1.2V trip point, a 5 $\mu$ A current is sunk into the pin to provide externally adjustable hysteresis.

**OV<sub>LOW</sub> (Pin 10):** V<sub>LOW</sub> Overvoltage Threshold Set Pin. A resistor divider from V<sub>LOW</sub> is needed to set this threshold. When the voltage on this pin rises past the 1.2V trip point, a 5 $\mu$ A current is sourced out of the pin to provide externally adjustable hysteresis.

**IMON (Pin 11):** The voltage on this pin is directly proportional to the average inductor currents of the 2 channels. 1.25V indicates zero average inductor current per phase.

**SETCUR (Pin 12):** This pin sets the maximum average inductor current in buck or boost mode. This pin sources 7.5 $\mu$ A.

**SNSA1<sup>+</sup>/SNSA2<sup>+</sup> (Pins 13 and 48):** AC Positive Current Sense Comparator Inputs. These inputs amplify the AC portion of the current signal to the IC's current comparator.

**SNS1<sup>-</sup>/SNS2<sup>-</sup> (Pins 14 and 47):** Negative Current Sense Comparator Inputs. The negative input of the current comparator is normally connected to V<sub>LOW</sub>.

**SNSD1<sup>+</sup>/SNSD2<sup>+</sup> (Pins 15 and 46):** DC Positive Current Sense Comparator Inputs. These inputs amplify the DC portion of the current signal to the IC's current comparator.

**BUCK (Pin 16):** The voltage on this pin determines if the IC is regulating the V<sub>LOW</sub> or V<sub>HIGH</sub> voltage/current. Float or tie this pin to V5 for buck mode operation. Ground this pin for boost mode operation.

**ILIM (Pin 17):** Current Comparator Sense Voltage Limit Selection Pin. The input impedance of this pin is 100k $\Omega$ .

**RUN (Pin 18):** Enable Control Input. A voltage above 1.22V turns on the IC. There is a 2 $\mu$ A pull-up current on this pin. Once the RUN pin rises above the 1.22V threshold the pull-up current increases to 6 $\mu$ A.

**FAULT (Pin 19):** Fault Indicator Output. Open-drain output that pulls to ground during a fault condition.

**DRVSET (Pin 20):** The voltage setting on this pin programs the DRV<sub>CC</sub> output voltage. The input impedance of this pin is 100k $\Omega$ .

**NC (Pins 21, 30, 32, 34, 40):** No Connect Pins.

**TG1/TG2 (Pins 22 and 39):** Top Gate Driver Outputs. This is the output of the floating driver with a voltage swing equal to DRV<sub>CC</sub> superimposed on the SW voltage.

**SW1/SW2 (Pins 23 and 38):** Switch Node Connections to the Inductors. Voltage swing at this pin is from a Schottky diode (external) voltage drop below ground to V<sub>HIGH</sub>.

**BOOST1/BOOST2 (Pins 24 and 37):** Boosted Floating Driver Supplies. The (+) terminal of the bootstrap capacitor connects to this pin. This pin swings from a diode drop below DRV<sub>CC</sub> up to V<sub>HIGH</sub>+DRV<sub>CC</sub>.

## PIN FUNCTIONS

**BG1/BG2 (Pins 25 and 36):** Bottom Gate Driver Outputs. This pin drives the gate(s) of the bottom N-channel MOSFET(s) between PGND and DRV<sub>CC</sub>.

**PGND1/PGND2 (Pins 26 and 35):** Power Ground Pin. Connect this pin closely to the source(s) of the bottom N-channel MOSFET(s), the (-) terminal of CDRV<sub>CC</sub> and (-) terminal of CV<sub>HIGH</sub>.

**EXTV<sub>CC</sub> (Pin 27):** External Power Input to an Internal LDO Connected to DRV<sub>CC</sub>. When the voltage on this pin is greater than the DRV<sub>CC</sub> LDO setting minus 500mV, this LDO bypasses the internal LDO powered from V<sub>HIGH</sub>.

**DRV<sub>CC</sub> (Pin 29):** Gate Driver Current Supply LDO Output. The voltage on this pin can be set from 6V to 10V in 1V increments. Bypass this pin to PGND with a minimum of 4.7μF low ESR tantalum or ceramic capacitor.

**V<sub>HIGH</sub> (Pin 31):** Main V<sub>HIGH</sub> supply. Bypass this pin to PGND with a capacitor (0.1μF to 1μF)

**PGATE (Pin 33):** Gate Drive for Input Short Protection. If a UV<sub>HIGH</sub> fault is detected, PGATE drives the gate of an external PMOS in series with the V<sub>HIGH</sub> rail high. Signal swings is from V<sub>HIGH</sub> to V<sub>HIGH</sub>-15V.

**CLKOUT (Pin 41):** Clock Output Pin. Use this pin to synchronize multiple LTC3871 ICs. Signal swing is from V<sub>5</sub> to ground.

**SYNC (Pin 42):** Applying a clock signal to this pin causes the internal PLL to synchronize the internal oscillator to the clock signal. The PLL compensation network is integrated onto the IC. This pin has a 100k internal resistor to ground.

**FREQ (Pin 43):** Frequency Set Pin. A resistor between this pin and SGND sets the switching frequency.

**MODE (Pin 44):** Tying this pin to SGND enables forced continuous mode in buck or boost modes. Floating this pin results in discontinuous mode when in buck mode and forced continuous mode in boost mode. Tying this pin to V<sub>5</sub> enables discontinuous mode in buck mode and non-synchronous operation in boost mode. The input impedance of this pin is 50kΩ.

**PHSMD (Pin 45):** Phase Mode Pin. This pin selects CH1 – CH2 and CH1 – CLKOUT phasing.

**GND (Exposed Pad Pin 49):** Ground. Must be soldered to PCB ground for rated thermal performance. Connect this pin closely to the sources of the bottom N-channel MOSFETs and negative terminal of V<sub>HIGH</sub>, DRV<sub>CC</sub>, V<sub>5</sub> bypass capacitors. All small signal components and compensation components should connect here. Signal ground pin should be connected to this exposed pad.

# BLOCK DIAGRAM

Bidirectional Controller with Current Programming and Monitoring Functions

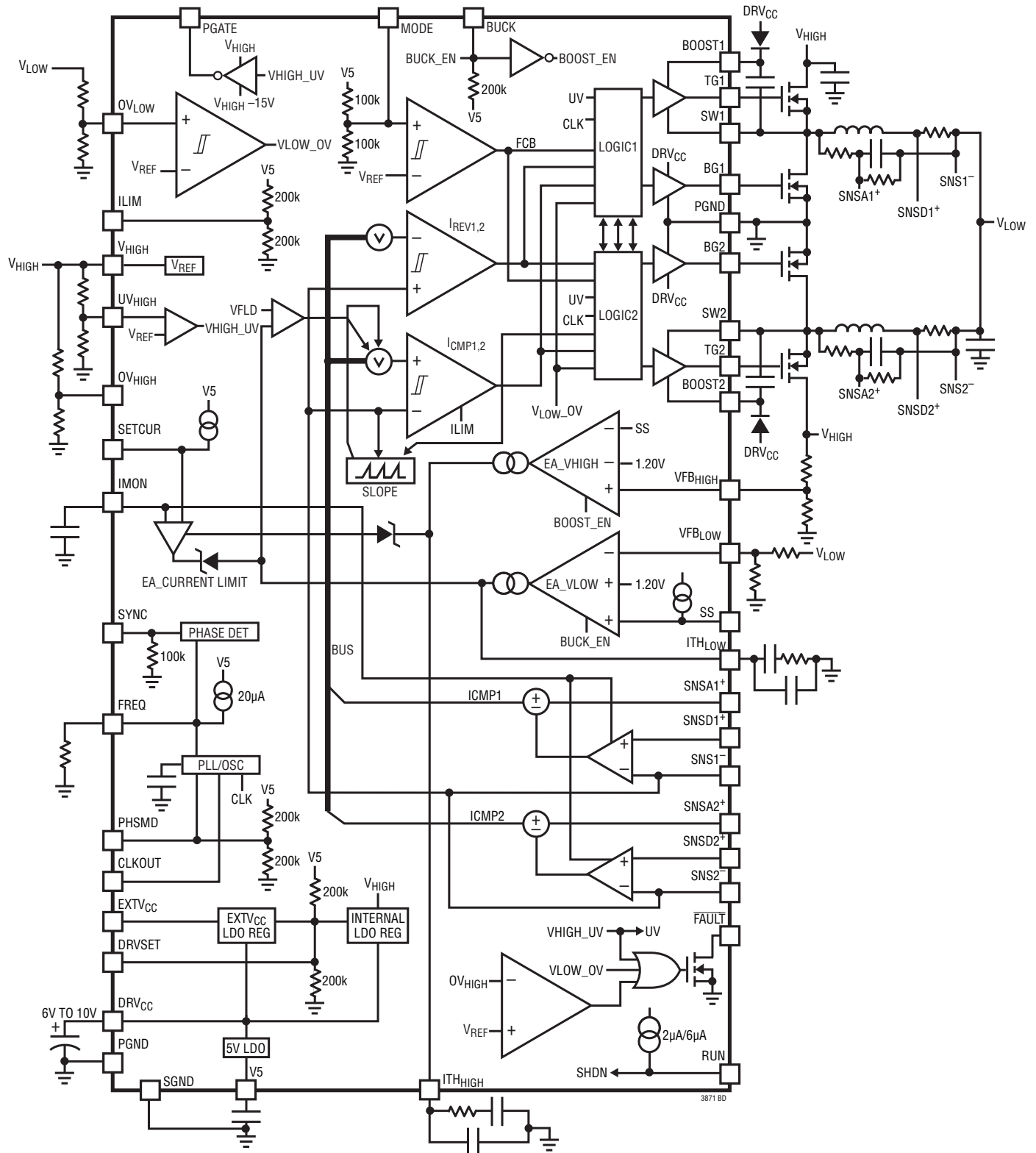

## OPERATION

### Main Control Loop

The LTC3871 is a bidirectional, constant-frequency, current mode step-down controller with two channels operating 180° or 120° out of phase. The LTC3871 is capable of delivering power from  $V_{HIGH}$  to  $V_{LOW}$  as well as from  $V_{LOW}$  back to  $V_{HIGH}$ . When power is delivered from  $V_{HIGH}$  to  $V_{LOW}$ , the LTC3871 operates as a peak-current mode constant-frequency buck regulator; and when power delivery is reversed, it operates as a valley current mode constant-frequency boost regulator. Four control loops, two for current and two for voltage, allow control of voltage or current on either  $V_{HIGH}$  or  $V_{LOW}$ . The LTC3871 uses an LTC-proprietary current sensing, current mode architecture. During normal buck mode operation, the top MOSFET is turned on every cycle when the oscillator sets the RS latch, and turned off when the main current comparator,  $I_{CMP}$ , resets the RS latch. The peak inductor current at which  $I_{CMP}$  resets the RS latch is controlled by the voltage on the ITH pin, which is the output of the error amplifier, EA. The error amplifier receives the feedback signal and compares it to the internal 1.2V reference. When the load current increases, it causes a slight change in the feedback pin voltage relative to the 1.2V reference, which in turn causes the ITH voltage to change until the inductor's average current equals the new load current. After the top MOSFET has turned off, the bottom synchronous MOSFET is turned on until the beginning of the next cycle.

The main control loop is shut down by pulling the RUN pin low. Releasing RUN allows an internal 2 $\mu$ A current source to pull-up the RUN pin. When the RUN pin reaches 1.22V, the main control loop is enabled and the IC is powered up and the pull-up current increases to 6.5 $\mu$ A. When the RUN pin is low, all functions are kept in a controlled shutdown state.

### Current Sensing with Low DCR

The LTC3871 employs a unique architecture to enhance the signal-to-noise ratio with low current sense offsets. That enables it to operate with a small current sense signal of a very low value inductor DCR to improve power efficiency, and reduce jitter due to switching noise which could corrupt the signal. The LTC3871 uses two positive current sense pins, SNSD<sup>+</sup> and SNSA<sup>+</sup>, to acquire signals and process them internally to provide the response equivalent

to a DCR sense signal that has a 14dB (5 times) signal-to-noise ratio. Accordingly, the current limit threshold is still a function of the inductor peak-current and its DCR value, and can be accurately set from 10mV to 50mV in 10mV steps with the ILIM pin. The filter time constant,  $R1 \cdot C1$ , of the SNSD<sup>+</sup> pin should match the L/DCR of the output inductor, while the filter at SNSA<sup>+</sup> pin should have a bandwidth of five times larger than SNSD<sup>+</sup>,  $R2 \cdot C2$  equals  $R1 \cdot C1/5$  (refer to Figure 3).

### Current Sensing with Low Value $R_{SENSE}$

The LTC3871 can also be used with an external low value  $R_{SENSE}$  resistor for increased accuracy. To accomplish this, the SNSA<sup>+</sup> pin needs a filter time constant  $R2 \cdot C2$  that has a bandwidth that is four times larger than the  $L/(R_{SENSE})$ . The SNSD<sup>+</sup> pin is now connected to the  $R_{SENSE}$  resistor as shown in Figure 1. A small filter cap may be used to filter out high frequency noise (refer to Figure 4).

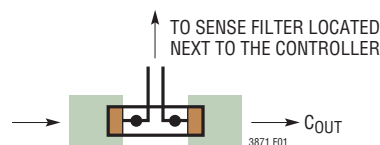

Figure 1. Sense Lines Placement with Sense Resistor

### DRV<sub>CC</sub>/EXTV<sub>CC</sub>/V5 Power

Power for the top and bottom MOSFET drivers is derived from the DRV<sub>CC</sub> pin. The DRV<sub>CC</sub> voltage can be set to anywhere from 6V to 10V in 1V steps using the DRVSET pin. When the EXTV<sub>CC</sub> pin is left open or tied to a voltage less than (DRV<sub>CC</sub> – 1V), an internal linear regulator supplies DRV<sub>CC</sub> power from  $V_{HIGH}$ . When EXTV<sub>CC</sub> is taken above (DRV<sub>CC</sub> – 500mV), the internal regulator between DRV<sub>CC</sub> and  $V_{HIGH}$  is turned off, and a second internal regulator is turned on between EXTV<sub>CC</sub> and DRV<sub>CC</sub>. Each top MOSFET driver is biased from a floating bootstrap capacitor, which normally recharges during each off cycle through an external diode when the top MOSFET turns off. If the input voltage,  $V_{HIGH}$ , decreases to a voltage close to  $V_{LOW}$ , the loop may enter dropout and attempt to turn on the top MOSFET continuously. The dropout detector detects this and forces the top MOSFET off for about one-twelfth of the clock period plus 100ns every fifth cycle to allow the bootstrap capacitor to recharge.

## OPERATION

Most of the internal circuitry is powered from the V5 rail that is generated by an internal linear regulator from  $DRV_{CC}$ . The V5 pin needs to be bypassed with a 2.2 $\mu$ F to 10 $\mu$ F external capacitor between V5 and SGND. This pin provides a 5.5V output that can supply up to 20mA of current. See the Application section for more details.

### Soft-Start (Buck Mode)

By default, the start-up of the  $V_{LOW}$  voltage is normally controlled by an internal soft-start ramp. The internal soft-start ramp represents a non-inverting input to the error amplifier. The  $VFB_{LOW}$  pin is regulated to the lower of the error amplifier's three non-inverting inputs (the internal soft-start ramp, the SS pin or the internal 1.2V reference). As the ramp voltage rises from 0V to 1.2V over approximately 1ms, the  $V_{LOW}$  voltage rises smoothly from its pre-biased value to its final set value. Certain applications can require the start-up of the converter into a non-zero load voltage, where residual charge is stored on the  $V_{LOW}$  capacitor at the onset of converter switching. In order to prevent the  $V_{LOW}$  from discharging under these conditions, the top and bottom MOSFETs are disabled until soft-start is greater than  $VFB_{LOW}$ .

### Soft-Start (Boost Mode)

The same internal soft-start capacitor and external soft-start capacitor are also active if the controller starts with boost mode of operation. The error amplifier for boost mode also tries to regulate to the lowest reference during start-up. However, the topology of the boost converter limits the effectiveness of this soft-start mechanism until the boost output voltage reaches its input voltage level. Therefore, it is recommended that the controller starts in buck mode of operation.

### Shutdown and Start-Up (RUN and SS Pins)

The LTC3871 can be shut down using the RUN pin. Pulling the RUN pin below 1.14V shuts down the main control loop for the controller and most internal circuits, including the  $DRV_{CC}$  and V5 regulators. Releasing the RUN pin allows an internal 2 $\mu$ A current to pull-up the pin and enable the controller. Alternatively, the RUN pin may be externally pulled up or driven directly by logic. Be careful not to exceed the absolute maximum rating of 6V on this pin. The

start-up of the controller's  $V_{LOW}$  voltage is controlled by the voltage on the SS pin. When the voltage on the SS pin is less than the 1.2V internal reference, the LTC3871 regulates the  $VFB_{LOW}$  voltage to the SS pin voltage instead of the 1.2V reference. This allows the SS pin to be used to program a soft-start by connecting an external capacitor from the SS pin to GND. An internal 1.25 $\mu$ A pull-up current charges this capacitor, creating a voltage ramp on the SS pin. As the SS voltage rises linearly from 0V to 1.2V (and beyond), the  $V_{LOW}$  voltage, rises smoothly from zero to its final value. When the RUN pin is pulled low to disable the controller, or when V5 drops below its undervoltage lockout threshold of 4.15V, the SS pin is pulled low by an internal MOSFET. When in undervoltage lockout, the controller is disabled and the external MOSFETs are held off. External circuitry can be added to discharge the soft-start capacitor during fault conditions to ensure a soft-start when the faults are cleared.

### Frequency Selection and Phase-Locked Loop (FREQ and SYNC Pins)

The selection of switching frequency is a trade-off between efficiency and component size. Low frequency operation increases efficiency by reducing MOSFET switching losses, but requires larger inductance and/or capacitance to maintain low output ripple voltage.

If the SYNC pin is not being driven by an external clock source, the FREQ pin can be used to program the controller's operating frequency from 50kHz to 500kHz. There is a precision 20 $\mu$ A current flowing out of the FREQ pin so that the user can program the controller's switching frequency with a single resistor to SGND. A curve is provided later in the Applications Information section showing the relationship between the voltage on the FREQ pin and switching frequency (Figure 7).

A phase-locked loop (PLL) is available on the LTC3871 to synchronize the internal oscillator to an external clock source that is connected to the SYNC pin. The PLL loop filter network is integrated inside the LTC3871. The phase-locked loop is capable of locking any frequency within the range of 60kHz to 460kHz. The frequency setting resistor should always be present to set the controller's initial switching frequency before locking to the external

## OPERATION

clock. The controller operates in the user selected mode when it is synchronized.

### Multiphase Operation

For output loads that demand high current, multiple LTC3871s can be daisy chained to run out of phase to provide more output current without increasing input and output voltage ripple. The SYNC pin allows the LTC3871 to synchronize to the CLKOUT signal of another LTC3871. The CLKOUT signal can be connected to the SYNC pin of the following LTC3871 stage to line up both the frequency and the phase of the entire system. Tying the PHSMD pin to V5, GND or floating, generates a phase difference (between CH1 and CLKOUT) of 240°, 60° or 90° respectively, and a phase difference (between CH1 and CH2) of 120°, 180° or 180°. Tying PHSMD to 1/4 or 3/4 of V5 generates a phase difference of 60° or 45° between CH1 and CLKOUT. Figure 2 shows the PHSMD connections necessary for 3-, 4-, 6-, 8- or 12-phase operation. A total of 12 phases can be daisy chained to run simultaneously out of phase with respect to each other. When paralleling multiple ICs, please be aware of the input impedance of pins connected to the same node.

### Undervoltage Lockout

The LTC3871 has two functions that help protect the controller in case of undervoltage conditions. A precision UVLO comparator constantly monitors the V5 voltage to ensure that an adequate voltage is present. It locks out the switching action when V5 is below 4.15V. To prevent oscillation when there is a disturbance on the V5, the UVLO comparator has 500mV of precision hysteresis.

Another way to detect an undervoltage condition is to monitor the V<sub>HIGH</sub> supply. Because the RUN pin has a precision turn-on reference of 1.22V, one can use a resistor divider to V<sub>HIGH</sub> to turn on the IC when V<sub>HIGH</sub> is high enough. An extra 4.5μA of current flows out of the RUN pin once the RUN pin voltage passes 1.22V. The RUN comparator itself has about 80mV of hysteresis. Additional hysteresis for the RUN comparator can be programmed by adjusting the values of the resistive divider. For accurate V<sub>HIGH</sub> undervoltage detection, V<sub>HIGH</sub> needs to be higher than 5V.

### Fault Flag ( $\overline{\text{FAULT}}$ , OV<sub>HIGH</sub>, OV<sub>LOW</sub> and UV<sub>HIGH</sub> Pins)

The  $\overline{\text{FAULT}}$  pin is connected to the open-drain of an internal N-channel MOSFET. It can be pulled high with an external resistor connected to a voltage up to 6V, such as V5 or an external bias voltage. The  $\overline{\text{FAULT}}$  pin is pulled low when:

- The RUN pin is below its turn on threshold.
- When V5 is below its UVLO threshold.
- Any of the three OV/UV comparators have been tripped.
- During a startup sequence until the SS pin charges up past 1.2V.

The OV<sub>LOW</sub> and OV<sub>HIGH</sub> thresholds are set using an external resistor dividers off of V<sub>LOW</sub> and V<sub>HIGH</sub>, respectively. When the voltage at the pin exceeds the comparator threshold of 1.2V, a 5μA hysteresis current is sourced out of the respective pin and the  $\overline{\text{FAULT}}$  signal goes low after a 125μs delay. The UV<sub>HIGH</sub> threshold is also set using an external resistor divider off V<sub>HIGH</sub>. When the voltage at the pin falls below the comparator threshold of 1.2V, a 5μA hysteresis current is sunk in to the UV<sub>HIGH</sub> pin and the  $\overline{\text{FAULT}}$  signal goes low after a 125μs delay. The amount of hysteresis can be adjusted by changing the total impedance of the resistor divider, while the resistor ratio sets the UV/OV trip point.

Besides flagging the  $\overline{\text{FAULT}}$  pin, the UV/OV comparators also affect the operation of the controller, as shown in Table 1.

When the OV<sub>LOW</sub> comparator crosses its 1.2V threshold:

- In buck mode, the controller stops switching.
- In boost mode, the controller continues to switch.
- ITH and SS are unaffected in both buck and boost modes. Whenever a fault is detected, discharge the SS pin as needed externally.

When the OV<sub>HIGH</sub> comparator crosses its 1st threshold of 1.2V:

- The controller stops switching in both buck and boost modes.
- ITH and SS are unaffected in both buck and boost modes. Whenever a fault is detected, discharge the SS pin as needed externally.

## OPERATION

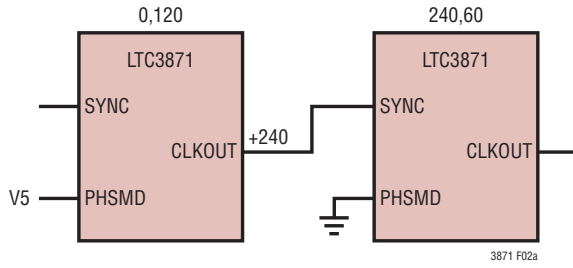

Figure 2a. 3-Phase Operation

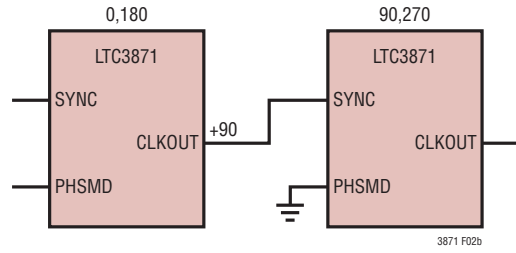

Figure 2b. 4-Phase Operation

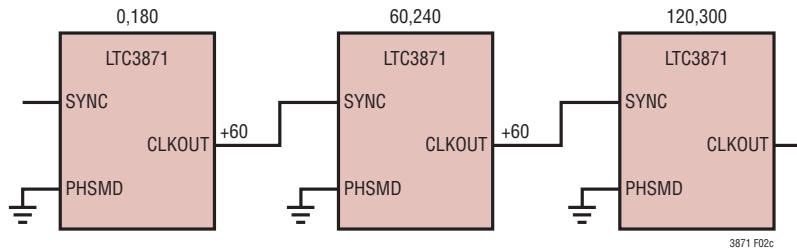

Figure 2c. 6-Phase Operation

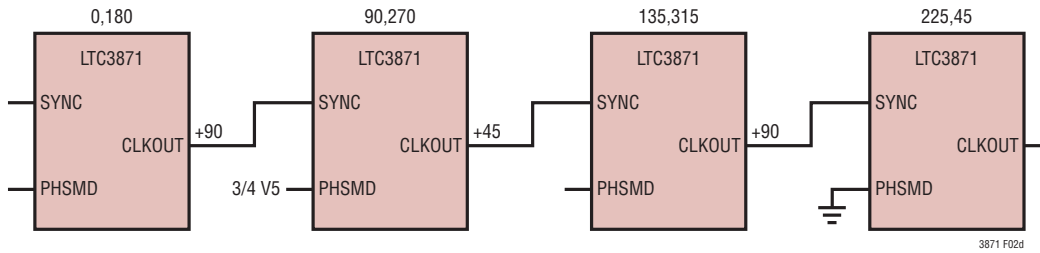

Figure 2d. 8-Phase Operation

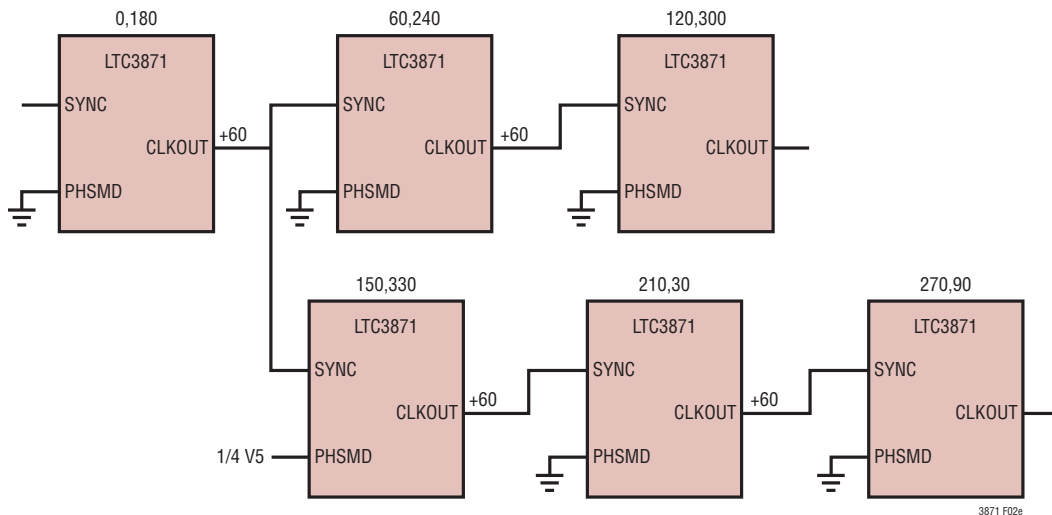

Figure 2e. 12-Phase Operation

## OPERATION

When the  $OV_{HIGH}$  comparator crosses its 2nd threshold of 3V:

- The controller stops switching in both buck and boost modes.
- Both ITH and IMON pins are driven into high impedance. This feature allows the users to isolate one LTC3871 from a multiphase system in the case a fault is detected on one particular IC.
- The SS pin is unaffected.

When the  $UV_{HIGH}$  comparator crosses its 1.2V threshold:

- In buck mode, the controller stops switching after a 125 $\mu$ sec delay and disconnects  $V_{HIGH}$  from  $V_{LOW}$  with an external P-channel MOSFET via the PGATE pin.
- In boost mode, the controller continues to switch, but it disconnects  $V_{HIGH}$  from  $V_{LOW}$  with an external P-channel MOSFET after a 125 $\mu$ sec delay. The voltage at the source side of the P-channel MOSFET is still regulated.
- ITH and SS are unaffected in both buck and boost modes. Whenever a fault is detected, discharge the SS pin as needed externally.

### Input Disconnect (PGATE Pin)

In a typical boost controller, the synchronous diode or the body diode of the synchronous MOSFET conducts current from the input to the output until the output is a diode drop below the input. As a result an output ( $V_{HIGH}$ ) short will drag the input ( $V_{LOW}$ ) down without a blocking diode or MOSFET to block the current. The LTC3871 uses an external low  $R_{DS(ON)}$  P-channel MOSFET for input short-circuit protection when  $V_{HIGH}$  is shorted to ground.

The PGATE pin drives the gate of an external MOSFET between  $V_{IN}$  and  $V_{HIGH}-15V$ —this pin is internally clamped to  $V_{HIGH}-15V$  to protect the gate oxide of the external MOSFET. In normal operation, the P-channel MOSFET is always on, with its gate-source voltage clamped to 15V maximum. When the  $UV_{HIGH}$  pin voltage goes below its 1.2V threshold,  $FAULT$  goes low 125 $\mu$ s later. At this point, the PGATE pin voltage transitions from  $V_{HIGH}-15V$  to  $V_{HIGH}$ , turning off the external P-channel MOSFET. The MOSFET needs to be connected such that its body diode will block the current path from  $V_{LOW}$  to  $V_{HIGH}$ . In buck mode, the switching action stops when PGATE is off and a fault condition is reported; In boost mode, the controller will still switch and regulate the programmed boost voltage on the source side of the PGATE. Output cap should be present at the source side of the PGATE. A fault condition is also reported in this case. The external P-channel MOSFET remains disconnected until  $V_{HIGH}$  rises high enough to un-trip the  $UV_{HIGH}$  comparator.

### Current Monitoring and Regulation (IMON, SETCUR Pins)

The inductor current can be sensed using either its DCR or a  $R_{SENSE}$  resistor. The current monitoring pin, IMON, outputs a voltage that is proportional to the average inductor current of the two channels sensed by the LTC3871. The operational range of IMON is 0.5V to 2.5V. When the average inductor current is zero, the IMON pin voltage rests at 1.25V. As the inductor current increases in buck mode, the  $I_{MON}$  voltage proportionally increases. The current sense signal to  $I_{MON}$  gain is 38 for the 10mV, 20mV and 30mV ILIM settings, and 19 for the 40mV and 50mV ILIM settings. An external voltage can be applied to the SETCUR pin to regulate the average output current. Because

Table 1: OV/UV Faults

FAULT	MODE	SWITCHING	ITH PINS	IMON	SS	PGATE PIN
$OV_{LOW}$ 1.2V Threshold	Buck	Stops	No Effect	No Effect	No Effect	Low
	Boost	Continues	No Effect	No Effect	No Effect	Low
$OV_{HIGH}$ 1.2V Threshold	Buck	Stops	No Effect	No Effect	No Effect	Low
	Boost	Stops	No Effect	No Effect	No Effect	Low
$OV_{HIGH}$ 3V Threshold	Buck	Stops	Hi-Z	Hi-Z	No Effect	Low
	Boost	Stops	Hi-Z	Hi-Z	No Effect	Low
$UV_{HIGH}$ 1.2V Threshold	Buck	Stops	No Effect	No Effect	No Effect	High
	Boost	Continues	No Effect	No Effect	No Effect	High

3871f



## OPERATION

SETCUR and IMON are the two inputs to the current loop gain amplifier with SETCUR acting as the reference, as the IMON pin voltage approaches SETCUR, the ITH pin control is taken over by the current regulation error amplifier from the voltage loop error amplifier.

In boost mode, the inductor current polarity is reversed, so the corresponding IMON and SETCUR ranges are 1.25V to 0.5V with 0.5V being the maximum boost current. The SETCUR pin sources an accurate 7.5 $\mu$ A current in both modes, allowing this voltage to be set with a single resistor for convenience. The SETCUR value defaults to the zero current value internally if the SETCUR pin sees a voltage that is out of range for the selected mode. The valid range of SETCUR is 1.25V to 2.5V for buck mode and 1.25V to 0.5V for boost mode. Therefore, if SETCUR voltage is set below 1.25V in buck mode, the internal SETCUR voltage is forced at 1.25V. If SETCUR voltage is set above 1.25V in boost mode, the internal SETCUR voltage is also forced at 1.25V. For battery charging applications, SETCUR can be programmed dynamically on-the-fly to set the charging currents to the batteries in either buck or boost mode. SETCUR can be used at start-up to limit the in-rush current in both buck mode and boost mode.

Use the following equation to calculate the voltages on IMON:

$$V_{\text{IMON}} = V_{\text{ZERO}} + K \cdot I_{\text{OUT}} \cdot R_{\text{SENSE}}/m; \text{ Buck Mode}$$

$$V_{\text{IMON}} = V_{\text{ZERO}} - K \cdot I_{\text{OUT}} \cdot R_{\text{SENSE}}/m; \text{ Boost Mode}$$

Where:

$V_{\text{IMON}}$ , the phase current voltage appears on IMON pin;

$V_{\text{ZERO}}$ , the IMON voltage when average output current is zero;  $V_{\text{ZERO}} = 1.25\text{V}$  typically

$$K = 38 \text{ if } I_{\text{LIM}} = 10\text{mV}; 20\text{mV}; \text{ or } 30\text{mV}$$

$$K = 19 \text{ if } I_{\text{LIM}} = 40\text{mV}; \text{ or } 50\text{mV}$$

$I_{\text{OUT}}$ , the total average output current,

$R_{\text{SENSE}}$ , the current sensing element value;

$m$ , the number of phases.

To defeat the current programming operation, tie the SETCUR pin to  $V_5$  in buck mode and ground the SETCUR pin in boost mode.

### Buck and Boost Modes (BUCK Pin)

The LTC3871 can be dynamically and seamlessly switched from buck mode to boost mode and vice versa via the BUCK pin. Tie this pin to  $V_5$  to select buck mode and to ground to select boost mode operation. This pin has an internal pull up resistor that defaults to buck mode if left floating. There are two separate error amplifiers for  $V_{\text{HIGH}}$  or  $V_{\text{LOW}}$  regulation. Having two error amplifiers allows fine tuning of the loop compensation for the buck and boost modes independently to optimize transient response. When buck mode is selected, the corresponding error amplifier is enabled, and  $I_{\text{TH}_{\text{LOW}}}$  voltage controls the peak inductor current. The other error amplifier is disabled and  $I_{\text{TH}_{\text{HIGH}}}$  is parked at its zero current level. In boost mode,  $I_{\text{TH}_{\text{HIGH}}}$  is enabled while  $I_{\text{TH}_{\text{LOW}}}$  is parked at its zero current level. During a buck to boost or a boost to buck transition, the internal soft-start is reset. Resetting soft-start and parking the ITH pin at the zero current level ensures a smooth transition to the newly selected mode. Refer to Table 2 for a summary.

To further minimize any transients, SETCUR can be programmed to 1.25V or zero current level before switching between boost and buck modes.

### Buck Mode Light Load Current Operation (DCM/CCM)

In buck mode, the LTC3871 can be enabled to enter discontinuous conduction mode or forced continuous conduction mode. To select forced continuous operation, tie the MODE

**Table 2: ITH PIN Parking Conditions**

PIN	MODE	PARKED	COMMENTS
ITH <sub>HIGH</sub>	Buck	Parked	OV <sub>HIGH</sub> 3V Threshold Overrides Park
	Boost	Parked in Prebias	OV <sub>HIGH</sub> 3V Threshold Overrides Park
ITH <sub>LOW</sub>	Buck	Parked in Prebias	OV <sub>LOW</sub> and OV <sub>HIGH</sub> 3V Threshold Overrides Park
	Boost	Parked	OV <sub>LOW</sub> and OV <sub>HIGH</sub> 3V Threshold Overrides Park

## OPERATION

pin to GND. To select discontinuous conduction mode of operation, tie the MODE pin to V5 or float it.

In forced continuous operation, the inductor current is allowed to reverse at light loads or under large transient conditions. The peak inductor current is determined by the voltage on the ITH<sub>LOW</sub> pin, just as in normal operation. In this mode, the efficiency at light loads is lower than in DCM mode operation. However, continuous mode has the advantages of lower output ripple and less interference with audio circuitry.

When the MODE pin is connected to V5 or left floating, the LTC3871 operates in discontinuous conduction mode at light loads. At very light loads, the current comparator, I<sub>CMP</sub>, may remain tripped for several cycles and force the external top MOSFET to stay off for the same number of cycles (i.e., skipping-pulses). The inductor current is not allowed to reverse (discontinuous operation). This mode, like forced continuous operation, exhibits low output ripple as well as low audio noise and reduced RF interference. It provides higher low current efficiency than forced continuous mode.

### Boost Mode Light Load Current Operation (DCM/CCM)

In boost mode, the LTC3871 can be enabled to enter constant-frequency discontinuous conduction mode or forced continuous conduction mode. To select forced-continuous operation, tie the MODE pin to GND or float

it. To select discontinuous conduction mode of operation, tie the MODE pin to V5.

In forced continuous operation, the inductor current is allowed to reverse at light loads or under large transient conditions. The inductor current valley is determined by the voltage on the ITH<sub>HIGH</sub> pin, just as in normal operation. In this mode, the efficiency at light loads is lower. However, continuous mode has the advantages of lower output ripple.

When the MODE pin is connected to V5, the LTC3871 operates with the synchronous N-channel MOSFET disabled, using the body diode of the MOSFET as the synchronous diode to reduce switching losses, and prevent reverse current. To reduce the MOSFET heat dissipation in this mode, parallel Schottky diodes are recommended.

### Thermal Shutdown

The LTC3871 has a temperature sensor integrated on the IC, to sense the die temperature near the gate driver circuits. When the die temperature exceeds 175°C, all switching actions stop, and the driver gate pins are held low, thus turning off all external MOSFETs. At the same time, the channels are disconnected from the IMON pins, and SS and ITH<sub>HIGH</sub>/ITH<sub>LOW</sub> pins continue to function normally, so as not to interfere with other LTC3871 chips that may reference the common pins. When the temperature drops 10°C below the trip threshold, normal operation resumes.

## APPLICATIONS INFORMATION

The Typical Application on the first page of this data sheet is a basic LTC3871 application circuit. In general, external component selection is driven by the load requirements, and begins with the DCR or  $R_{\text{SENSE}}$  and inductor value. Next, power MOSFETs are selected. Finally,  $V_{\text{HIGH}}$  and  $V_{\text{LOW}}$  capacitors are selected.

### Slope Compensation and Inductor Peak Current

Slope compensation provides stability in constant frequency architectures by preventing sub-harmonic oscillations at high duty cycles. It is accomplished internally by adding a compensating ramp to the inductor current signal at duty cycles in excess of 40%. For high duty cycle applications, the maximum current is reduced. A curve of maximum peak current vs. duty cycle is given in the Typical Performance Characteristics section.

### Current Limit Programming

The ILIM pin is a 5-level logic input which sets the maximum current limit of the controller. Table 3 shows the five ILIM settings. Please note that these settings represent the peak inductor current setting. Because of the inductor ripple current, the average output current is lower than the peak current. Setting ILIM using a resistor divider off of  $V_5$  will allow the maximum current sense threshold setting to not change when the 5.5V LDO is in dropout at start-up. Please note that the ILIM pin has an internal 200k pull-down to SGND and a 200k pull-up to  $V_5$ .

Table 3. ILIM Settings

ILIM Pin Voltage	Max Current Sense Threshold	
	DCR Sensing	$R_{\text{SENSE}}$
0	10mV	12.5mV
1/4 $V_5$	20mV	25mV
Float	30mV	37.5mV
3/4 $V_5$	40mV	50mV
$V_5$	50mV	62.5mV

### SNSD<sup>+</sup>, SNSA<sup>+</sup> and SNS<sup>-</sup> Pins

The SNSA<sup>+</sup> and SNS<sup>-</sup> pins are the inputs to the current comparators, while the SNSD<sup>+</sup> pin is the input of an internal DC amplifier. The operating input voltage range is 0V to 30V for all three sense pins. All the positive sense pins that are connected to the current comparator or the

amplifier are high impedance with input bias currents of less than 1 $\mu$ A. The SNS<sup>-</sup> pin is not a high impedance pin. For  $V_{\text{LOW}}$  voltages greater than  $V_5$ , the current comparators derive their bias currents directly off of SNS<sup>-</sup>. The SNS<sup>-</sup> pins should be connected directly to  $V_{\text{LOW}}$ . Care must be taken not to float these pins during normal operation. Filter components, especially capacitors, must be placed close to the LTC3871, and the sense lines should run close together to a Kelvin connection underneath the current sense element (Figure 1). Because the LTC3871 is designed to be used with a very low value sensing element to sense inductor current, without proper care, the parasitic resistance, capacitance and inductance will degrade the current sense signal integrity, making the programmed current limit unpredictable. As shown in Figure 3, resistors R1 and R2 are placed close to the output inductor and capacitors C1 and C2 are close to the IC pins to prevent noise coupling to the sense signal.

### Inductor DCR Sensing

The LTC3871 is specifically designed for high load current applications requiring the highest possible efficiency; it is capable of sensing the signal of an inductor DCR in the milliohm range (Figure 3). The DCR is the DC winding resistance of the inductor's copper, which is often 1m $\Omega$  for high current inductors. In high current applications, the conduction loss of a high DCR or a sense resistor will cause a significant reduction in power efficiency. The SNSD<sup>+</sup> pin connects to the filter that has a  $R1 \cdot C1$  time constant matched to  $L/\text{DCR}$  of the inductor. The SNSA<sup>+</sup> pin is connected to the second filter with the time constant one-fifth that of  $R1 \cdot C1$ . For a specific output requirement, choose the inductor with the DCR that satisfies the maximum desired sense voltage, and uses the relationship

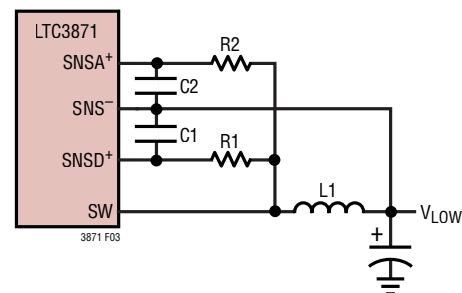

Figure 3. Inductor DCR Sensing

## APPLICATIONS INFORMATION

of the sense pin filters to output inductor characteristics as depicted below.

$$DCR = \frac{V_{SENSE(MAX)}}{I_{MAX} + \frac{\Delta I_L}{2}}$$

$$L/DCR = R1 \cdot C1 = 5 \cdot R2 \cdot C2$$

where:

$V_{SENSE(MAX)}$ : Maximum sense voltage for a given ILIM threshold

$\Delta I_L$ : Inductor ripple current

L, DCR: Output inductor characteristics

$R1 \cdot C1$ : Filter time constant of the SNSD<sup>+</sup> pin

$R2 \cdot C2$ : Filter time constant of the SNSA<sup>+</sup> pin

To ensure that the load current will be delivered over the full operating temperature range, the temperature coefficient of DCR resistance, approximately 0.4%/°C, should be taken into account.

Typically, C1 and C2 are selected in the range of 0.047μF to 0.47μF. If C1 and C2 are chosen to be 0.47μF, and an inductor of 10μH with 3mΩ DCR is selected, R1 and R2 will be 6.98kΩ and 1.4kΩ respectively. The bias current at SNSD<sup>+</sup> and SNSA<sup>+</sup> is less than 1μA, and it introduces a small error to the sense signal.

There will be some power loss in R1 and R2 that relates to the duty cycle, and will be the most in continuous mode at the maximum  $V_{HIGH}$  voltage:

$$P_{LOSS}(R) = \frac{(V_{HIGH(MAX)} - V_{LOW}) \cdot V_{LOW}}{R}$$

Ensure that R1 and R2 have a power rating higher than this value. Care has to be taken for voltage coefficients of these resistors at high  $V_{HIGH}$  voltages. Multiple resistors can be used in series to minimize this effect. However, DCR sensing eliminates the conduction loss of a sense resistor; and provides better efficiency at heavy loads. To maintain a good signal-to-noise ratio for the current sense signal, use a minimum of 10mV between SNSA<sup>+</sup> and SNS<sup>-</sup> pins or the equivalent of 2mV ripple on the current sense signal for duty cycles less than 40%. The actual ripple voltage

across SNSA<sup>+</sup> and SNS<sup>-</sup> pins will be determined by the following equation:

$$\Delta V_{SENSE} = \frac{V_{LOW}}{V_{HIGH}} \cdot \frac{V_{HIGH} - V_{LOW}}{R1 \cdot C1 \cdot f_{OSC}}$$

### Sensing Using an $R_{SENSE}$ Resistor

The LTC3871 can be used with an external  $R_{SENSE}$  resistor to sense current accurately. The external components required to accomplish this are shown in Figure 4. The SNSD<sup>+</sup> pin senses directly across the  $R_S$  resistor. The R1, C1 network provides the current signal path to the SNSA<sup>+</sup> pin. Internally the signals from the AC and DC paths are combined for accurate current sensing and low jitter performance. Resistor R2 is used to divide down the DC component of the signal seen by SNSA<sup>+</sup> due to the DCR of the inductor. As a rule of thumb, R2 needs to be 10 times smaller than R1 so the DCR value can be safely ignored.

The  $R1 \cdot C1$  time constant should be selected such that:

$$L/R_S = 4 \cdot R1 \cdot C1 \text{ for } R1 = 10 \cdot R2$$

### Pre-Biased Output Start-Up

There may be situations that require the power supply to start up with a pre-bias on the  $V_{LOW}$  output capacitors. In this case, it is desirable to start up without discharging that output pre-bias. The LTC3871 can safely power up into a pre-biased output without discharging it.

The LTC3871 accomplishes this by disabling both the top and bottom MOSFETs until the SS pin voltage and the internal soft-start voltage are above the  $V_{FB_{LOW}}$  pin voltage. When  $V_{FB_{LOW}}$  is higher than SS or the internal

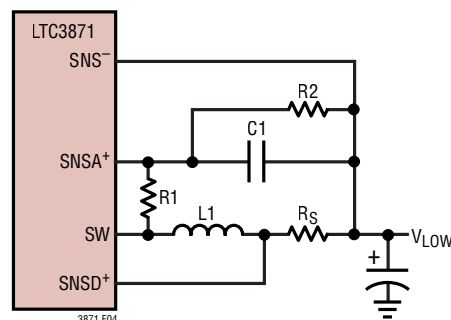

Figure 4.  $R_{SENSE}$  Resistor Sensing

## APPLICATIONS INFORMATION

soft-start voltage, the error amp output is parked at its zero current level. Disabling both top and bottom MOSFETs prevents the pre-biased output voltage from being discharged. When SS and the internal soft-start both cross 1.32V or  $V_{FB}$ , whichever is lower, both top and bottom MOSFETs are enabled.

### Buck Mode Overcurrent Fault

When the output of the power supply is loaded beyond its preset current limit, the regulated output voltage will collapse depending on the load. The  $V_{LOW}$  rail may be shorted to ground through a very low impedance path or it may be a resistive short, in which case the output will collapse partially, until the load current equals the preset current limit. The controller will continue to source current into the short. The amount of current sourced depends on the ILIM pin setting and the  $V_{FB_{LOW}}$  voltage as shown in the Current Foldback graph in the Typical Performance Characteristics section.

Upon removal of the short,  $V_{LOW}$  soft starts using the internal soft-start, thus reducing output overshoot. In the absence of this feature, the output capacitors would have been charged at current limit, and in applications with minimal output capacitance this may have resulted in output overshoot. Current limit foldback is not disabled during an overcurrent recovery. The load must drop below the folded back current limit threshold in order to restart from a hard short.

### Boost Mode Overcurrent Fault

When in boost mode, if the overcurrent situation persists and discharges  $V_{HIGH}$  below the preset  $UV_{HIGH}$  trip point, The PGATE pin turns off the external disconnect P-channel MOSFET, preventing  $V_{LOW}$  from getting discharged via the top MOSFET body diode. For both buck and boost mode of operation, current regulation loop can be used to limit the current by forcing a voltage on SETCUR pin. The zero average inductor current can be obtained by forcing 1.25V on SETCUR. If the SETCUR voltage is set to an invalid range for the selected mode of operation, the effective SETCUR voltage is internally set to 1.25V.

One way of protecting against an input  $V_{HIGH}$  soft short in boost mode is to monitor the  $I_{MON}$  voltage. If the  $I_{MON}$

voltage indicates excessive current, an external circuit can be added to simulate an UV condition at the input and turn off PGATE.

### Inductor Value Calculation

Given the desired input and output voltages, the inductor value and operating frequency,  $f_{OSC}$ , directly determine the inductor's peak-to-peak ripple current:

$$I_{RIPPLE} = \frac{V_{LOW}}{V_{HIGH}} \left( \frac{V_{HIGH} - V_{LOW}}{f_{OSC} \cdot L} \right)$$

Lower ripple current reduces core losses in the inductor, ESR losses in the output capacitors, and output voltage ripple. Thus, highest efficiency operation is obtained at low frequency with a small ripple current. Achieving this, however, requires a large inductor.

A reasonable starting point is to choose a ripple current that is about 40% of the maximum inductor current. Note that the largest ripple current occurs at the highest  $V_{HIGH}$  voltage. To guarantee that ripple current does not exceed a specified maximum, the inductor should be chosen according to:

$$L \geq \frac{V_{HIGH} - V_{LOW}}{f_{OSC} \cdot I_{RIPPLE}} \cdot \frac{V_{LOW}}{V_{HIGH}}$$

### Inductor Core Selection

Once the inductance value is determined, the type of inductor must be selected. Core loss is independent of core size for a fixed inductor value, but it is very dependent on inductance selected. As inductance increases, core losses go down. Unfortunately, increased inductance requires more turns of wire and therefore copper losses will increase.

Ferrite designs have very low core loss and are preferred at high switching frequencies, so design goals can concentrate on copper loss and preventing saturation. Ferrite core material saturates "hard," which means that inductance collapses abruptly when the peak design current is exceeded. This results in an abrupt increase in inductor ripple current and consequent output voltage ripple. Do not allow the core to saturate!

## APPLICATIONS INFORMATION

### Power MOSFET and Schottky Diode (Optional) Selection

At least two external power MOSFETs need to be selected: One N-channel MOSFET for the top switch and one or more N-channel MOSFET(s) for the bottom switch. The number, type and on-resistance of all MOSFETs selected take into account the voltage step-down ratio as well as the actual position (main or synchronous) in which the MOSFET will be used. A much smaller and much lower input capacitance MOSFET should be used for the top MOSFET in applications that have an  $V_{LOW}$  that is less than one-third of  $V_{HIGH}$ . In applications where  $V_{HIGH} \gg V_{LOW}$ , the top MOSFETs' on-resistance is normally less important for overall efficiency than its input capacitance at operating frequencies above 300kHz. MOSFET manufacturers have designed special purpose devices that provide reasonably low on-resistance with significantly reduced input capacitance for the main switch application in switching regulators.

The peak-to-peak MOSFET gate drive levels are set by the internal  $DRV_{CC}$  regulator voltage. Pay close attention to the  $BV_{DSS}$  specification for the MOSFETs as well. Selection criteria for the power MOSFETs include the on-resistance  $R_{DS(ON)}$ , input capacitance, input voltage and maximum output current. MOSFET input capacitance is a combination of several components but can be taken from the typical gate charge curve included on most data sheets (Figure 5). The curve is generated by forcing a constant input current into the gate of a common source, current source loaded stage and then plotting the gate voltage versus time.

The initial slope is the effect of the gate-to-source and the gate-to-drain capacitance. The flat portion of the curve is the result of the Miller multiplication effect of the drain-to-gate capacitance as the drain drops the voltage across the current source load. The upper sloping line is due to the drain-to-gate accumulation capacitance and

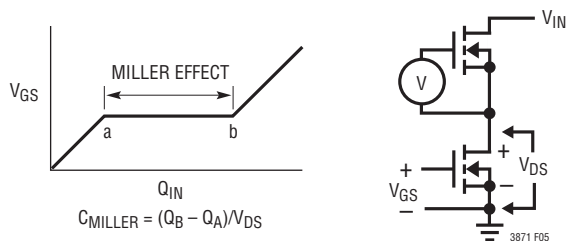

Figure 5. Gate Charge Characteristic

the gate-to-source capacitance. The Miller charge (the increase in coulombs on the horizontal axis from a to b while the curve is flat) is specified for a given  $V_{DS}$  drain voltage, but can be adjusted for different  $V_{DS}$  voltages by multiplying the ratio of the application  $V_{DS}$  to the curve specified  $V_{DS}$  values. A way to estimate the  $C_{MILLER}$  term is to take the change in gate charge from points a and b on a manufacturer's data sheet and divide by the stated  $V_{DS}$  voltage specified.  $C_{MILLER}$  is the most important selection criteria for determining the transition loss term in the top MOSFET but is not directly specified on MOSFET data sheets.  $C_{RSS}$  and  $C_{OS}$  are specified sometimes but definitions of these parameters are not included. When the controller is operating in continuous mode the duty cycles for the top and bottom MOSFETs are given by:

$$\text{Main Switch Duty Cycle} = \frac{V_{LOW}}{V_{HIGH}}$$

$$\text{Synchronous Switch Duty Cycle} = \left( \frac{V_{HIGH} - V_{LOW}}{V_{HIGH}} \right)$$

The power dissipation for the main and synchronous MOSFETs at maximum output current are given by:

$$P_{MAIN} = \frac{V_{LOW}}{V_{HIGH}} (I_{MAX})^2 (1 + \delta) R_{DS(ON)} + (V_{HIGH})^2 \left( \frac{I_{MAX}}{2} \right) (R_{DR}) (C_{MILLER}) \cdot \left[ \frac{1}{DRV_{CC} - V_{TH(MIN)}} + \frac{1}{V_{TH(MIN)}} \right] \cdot f$$

$$P_{SYNC} = \frac{V_{HIGH} - V_{LOW}}{V_{HIGH}} (I_{MAX})^2 (1 + \delta) R_{DS(ON)}$$

$I_{MAX}$  = Maximum Inductor Current.

where  $\delta$  is the temperature dependency of  $R_{DS(ON)}$ ,  $R_{DR}$  is the effective top driver resistance (approximately  $5\Omega$  at  $V_{GS} = V_{MILLER}$ );  $V_{HIGH}$  is the drain potential and the change in drain potential in the particular application.  $V_{TH(MIN)}$  is the data sheet specified typical gate threshold voltage specified in the power MOSFET data sheet at the specified drain current.  $C_{MILLER}$  is the calculated capacitance using

## APPLICATIONS INFORMATION

the gate charge curve from the MOSFET data sheet and the technique described above.

Both MOSFETs have  $I^2R$  losses while the topside N-channel equation includes an additional term for transition losses, which peak at the highest input voltage. The bottom MOSFET losses are greatest at high  $V_{HIGH}$  voltage when the top switch duty factor is low or during a  $V_{LOW}$  short-circuit when the bottom switch is on close to 100% of the period.

The term  $(1 + \delta)$  is generally given for a MOSFET in the form of a normalized  $R_{DS(ON)}$  vs temperature curve, but  $\delta = 0.005/^\circ\text{C}$  can be used as an approximation for low voltage MOSFETs.

An optional Schottky diode across the bottom MOSFET conducts during the dead time between the conduction of the two large power MOSFETs in buck mode. This prevents the body diode of the bottom MOSFET from turning on, storing charge during the dead time and requiring a reverse-recovery period which could cost as much as several percent in efficiency. A 2A to 8A Schottky is generally a good compromise for both regions of operation due to the relatively small average current. Larger diodes result in additional transition loss due to their larger junction capacitance.

An optional Schottky diode across the top MOSFET is also recommended for Boost DCM operation. This will increase efficiency and reduce heat dissipation for large output currents.

### $C_{HIGH}$ and MOSFETs Selection (on $V_{HIGH}$ and $V_{LOW}$ )

In continuous mode, the source current of the top MOSFET is a square wave of duty cycle  $(V_{LOW})/(V_{HIGH})$ . To prevent large voltage transients, a low ESR capacitor sized for the maximum RMS current of one channel must be used. In the following discussion, it is assumed that  $C_{IN}$  is  $C_{HIGH}$ ,  $C_{OUT}$  is  $C_{LOW}$ ,  $V_{IN}$  is  $V_{HIGH}$ , and  $V_{OUT}$  is  $V_{LOW}$ . The maximum RMS capacitor current is given by:

$$C_{IN} \text{ Required } I_{RMS} \approx \frac{I_{MAX}}{V_{IN}} \left[ (V_{OUT})(V_{IN} - V_{OUT}) \right]^{1/2}$$

This formula has a maximum at  $V_{IN} = 2V_{OUT}$ , where  $I_{RMS} = I_{OUT}/2$ . This simple worst-case condition is commonly used for design because even significant deviations do not

offer much relief. Note that capacitor manufacturers' ripple current ratings are often based on only 2000 hours of life.

This makes it advisable to further de-rate the capacitor, or to choose a capacitor rated at a higher temperature than required. Several capacitors may be paralleled to meet size or height requirements in the design. Ceramic capacitors can also be used for  $C_{IN}$ . Always consult the manufacturer if there is any question.

Ceramic capacitors are becoming very popular for small designs but several cautions should be observed. X7R, X5R and Y5V are examples of a few of the ceramic materials used as the dielectric layer, and these different dielectrics have very different effect on the capacitance value due to the voltage and temperature conditions applied. Physically, if the capacitance value changes due to applied voltage change, there is a concomitant piezo effect which results in radiating sound! A load that draws varying current at an audible rate may cause an attendant varying input voltage on a ceramic capacitor, resulting in an audible signal. A secondary issue relates to the energy flowing back into a ceramic capacitor whose capacitance value is being reduced by the increasing charge. The voltage can increase at a considerably higher rate than the constant current being supplied because the capacitance value is decreasing as the voltage is increasing! Nevertheless, ceramic capacitors, when properly selected and used, can provide the lowest overall loss due to their extremely low ESR.

A small (0.1  $\mu\text{F}$  to 1  $\mu\text{F}$ ) bypass capacitor,  $C_{IN}$ , between the chip  $V_{IN}$  pin and ground, placed close to the LTC3871, is also suggested. A 2.2 $\Omega$  to 10 $\Omega$  resistor placed between  $C_{IN}$  and  $V_{IN}$  pin provides further isolation.

The selection of  $C_{OUT}$  at  $V_{OUT}$  is driven by the required effective series resistance (ESR). Typically once the ESR requirement is satisfied the capacitance is adequate for filtering. The steady-state output ripple ( $\Delta V_{OUT}$ ) is determined by:

$$\Delta V_{OUT} \approx \Delta I_{RIPPLE} \left( \text{ESR} + \frac{1}{8fC_{OUT}} \right)$$

where  $f$  = operating frequency,  $C_{OUT}$  = output capacitance and  $\Delta I_{RIPPLE}$  = ripple current in the inductor. The output ripple is highest at maximum input voltage since  $\Delta I_{RIPPLE}$

## APPLICATIONS INFORMATION

increases with input voltage ( $V_{HIGH}$ ). The output ripple will be less than 50mV at maximum  $V_{IN}$  with  $\Delta I_{RIPPLE} = 0.4I_{OUT(MAX)}$  assuming:

$$C_{OUT} \text{ required ESR} < N \cdot R_{SENSE}$$

and

$$C_{OUT} > \frac{1}{(8f)(R_{SENSE})}$$

The emergence of very low ESR capacitors in small, surface mount packages makes very small physical implementations possible. The ability to externally compensate the switching regulator loop using the ITH pin allows a much wider selection of output capacitor types. The impedance characteristic of each capacitor type is significantly different than an ideal capacitor and therefore requires accurate modeling or bench evaluation during design. Manufacturers such as Nichicon, Nippon Chemi-Con and Sanyo should be considered for high performance through-hole capacitors. The OS-CON semiconductor dielectric capacitors available from Sanyo and the Panasonic SP surface mount types have a good (ESR)(size) product.

Once the ESR requirement for  $C_{OUT}$  has been met, the RMS current rating generally far exceeds the  $I_{RIPPLE(P-P)}$  requirement. Ceramic capacitors from AVX, Taiyo Yuden, Murata and TDK offer high capacitance value and very low ESR, especially applicable for low output voltage applications.

In surface mount applications, multiple capacitors may have to be paralleled to meet the ESR or RMS current handling requirements of the application. Aluminum electrolytic and dry tantalum capacitors are both available in surface mount configurations. New special polymer surface mount capacitors offer very low ESR also but have much lower capacitive density per unit volume. In the case of tantalum, it is critical that the capacitors are surge tested for use in switching power supplies. Several excellent choices are the AVX TPS, AVX TPSV, the KEMET T510 series of surface mount tantalums or the Panasonic SP series of surface mount special polymer capacitors available in case heights ranging from 2mm to 4mm. Other capacitor types include Sanyo POSCAP, Sanyo OS-CON, Nichicon PL series and Sprague 595D series. Consult the manufacturers for other specific recommendations.

### $C_{HIGH}$ Capacitor Selection for Boost Operation

Contributions of ESR (equivalent series resistance), ESL (equivalent series inductance) and the bulk capacitance must be considered when choosing the correct combination of output capacitors for a boost converter application.

The choice of component(s) begins with the maximum acceptable ripple voltage (expressed as a percentage of the output voltage), and how this ripple should be divided between the ESR step and the charging/discharging  $\Delta V$ . For the purpose of simplicity we will choose 2% for the maximum output ripple, to be divided equally between the ESR step and the charging/discharging  $\Delta V$ . This percentage ripple will change, depending on the requirements of the application, and the equations provided below can easily be modified.

One of the key benefits of multiphase operation is a reduction in the peak current supplied to the output capacitor by the boost diodes. As a result, the ESR requirement of the capacitor is relaxed. For a 1% contribution to the total ripple voltage, the ESR of the output capacitor can be determined using the following equation:

$$ESR_{C_{OUT}} \leq \frac{0.01 \cdot V_{OUT}}{I_{D(PEAK)}}$$

where:

$$I_{D(PEAK)} = \frac{1}{n} \cdot \left( 1 + \frac{\chi}{2} \right) \cdot \frac{I_{O(MAX)}}{1 - D_{MAX}}$$

The factor  $n$  represents the number of phases and the factor  $\chi$  represents the percentage inductor ripple current.

For the bulk capacitance, which we assume contributes 1% to the total output ripple, the minimum required capacitance is approximately:

$$C_{OUT} \geq \frac{I_{O(MAX)}}{0.01 \cdot n \cdot V_{OUT} \cdot f}$$

For many designs it will be necessary to use one type of capacitor to obtain the required ESR, and another type to satisfy the bulk capacitance. For example, using a low ESR ceramic capacitor can minimize the ESR step,



## APPLICATIONS INFORMATION

while an electrolytic capacitor can be used to supply the required bulk C.

The voltage rating of the output capacitor must be greater than the maximum output voltage, with sufficient derating to account for the maximum capacitor temperature.

Because the ripple current in the output capacitor is a square wave, the ripple current requirements for this capacitor depend on the duty cycle, the number of phases and the maximum output current. In order to choose a ripple current rating for the output capacitor, first establish the duty cycle range, based on the output voltage and range of input voltage.

The output ripple current is divided between the various capacitors connected in parallel at the output voltage. Although ceramic capacitors are generally known for low ESR (especially X5R and X7R), these capacitors suffer from a relatively high voltage coefficient. Therefore, it is not safe to assume that the entire ripple current flows in the ceramic capacitor. Aluminum electrolytic capacitors are generally chosen because of their high bulk capacitance, but they have a relatively high ESR. As a result, some amount of ripple current will flow in this capacitor. If the ripple current flowing into a capacitor exceeds its RMS rating, the capacitor will heat up, reducing its effective capacitance and adversely affecting its reliability. After the output capacitor configuration has been determined using the equations provided, measure the individual capacitor case temperatures in order to verify good thermal performance.

### Setting Output Voltage

The LTC3871 output voltage is set by two external feedback resistive dividers carefully placed across  $V_{HIGH}$  to ground and  $V_{LOW}$  to ground, as shown in Figure 6. The regulated output voltage is determined by:

$$V_{LOW} = 1.2V \cdot \left(1 + \frac{R_B}{R_A}\right) \text{ and } V_{HIGH} = 1.2V \cdot \left(1 + \frac{R_D}{R_C}\right)$$

To improve the frequency response, a feed forward capacitor,  $C_{FF1}/C_{FF2}$ , may be used. Great care should be taken to route the feedback line away from noise sources, such as the inductor or the SW line.

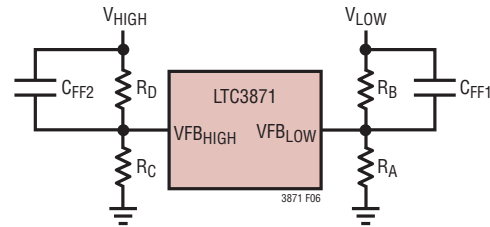

Figure 6. Setting Output Voltage

### External Soft-Start

The LTC3871 has the ability to soft-start by itself using the internal soft-start or at a slower rate with an external capacitor on the SS pin. The controller is in the shutdown state if its RUN pin voltage is below 1.14V and its SS pin is actively pulled to ground in this shutdown state. If the RUN pin voltage is above 1.22V, the controller powers up. Once V5 passes its UVLO threshold and power on reset delay expires, a soft-start current of 1.25 $\mu$ A then starts to charge the SS soft-start capacitor. Note that soft-start is achieved not by limiting the maximum  $V_{LOW}$  output current of the controller but by controlling the output ramp voltage according to the ramp rate on the SS pin. Current foldback is enabled during this phase. The soft-start range is defined to be the voltage range from 0V to 1.2V on the SS pin. The total soft-start time can be calculated as:

$$t_{SOFTSTART} = 1.2 \cdot \frac{C_{SS}}{1.25\mu A}$$

### The Internal LDOs

The LTC3871 features three internal PMOS LDOs that supplies power to  $DRV_{CC}$  from either the  $V_{HIGH}$  or  $V_{LOW}$  supply, and also generates the V5 rail from  $DRV_{CC}$ .  $DRV_{CC}$  powers the top and bottom gate drive circuits, and V5 powers the LTC3871's internal circuitry.

There are two  $DRV_{CC}$  LDOs—one that generates  $DRV_{CC}$  from  $V_{HIGH}$  (LDO1) and another that generates  $DRV_{CC}$  from  $V_{LOW}$  (LDO2), thus allowing the part to start up with just one of the two rails present! Only one of them is active at any given time. If  $V_{LOW}$  is higher than the  $EXTV_{CC}$  switchover threshold, LDO2 is active; if it is below the switchover threshold, LDO1 is active. The  $DRV_{CC}$  pin regulation voltage is determined by the state of the  $DRVSET$  pin. The  $DRVSET$  pin is a 5-level logic. When  $DRVSET$  is either

## APPLICATIONS INFORMATION

grounded, floated or tied to V5, the typical value for the DRV<sub>CC</sub> voltage will be 6V, 8V and 10V respectively. Use the 10V setting with careful PCB layout. This is because any overshoot between BOOST and SW would exceed the ABS max voltage of 11V for the floating driver. Set DRV<sub>CC</sub> to one-fourth of V5 and three-fourths of V5 for 7V and 9V DRV<sub>CC</sub> voltages. Setting DRVSET using a resistor divider off of V5 will allow the DRVSET setting to not change when the 5.5V LDO is in dropout at start-up. Please note that the DRVSET pin has an internal 200k pull-down to SGND and a 200k pull-up to V5. The EXT<sub>V</sub><sub>CC</sub> turn on threshold is the selected DRV<sub>CC</sub> regulation voltage minus 500mV. The turn off threshold is 500mV below the turn on threshold.

The V5 LDO regulates the voltage at the V5 pin to 5.5V when DRV<sub>CC</sub> is at least 6V. The LDO can supply a peak current of 20mA and must be bypassed to ground with a minimum of 4.7μF ceramic capacitor or low ESR electrolytic capacitor. No matter what type of bulk capacitor is used, an additional 0.1μF ceramic capacitor placed directly adjacent to the V5 and SGND pins is highly recommended.

### Fault Conditions: Current Limit and Current Foldback

In buck mode, the LTC3871 includes current foldback to help limit power dissipation when the V<sub>LOW</sub> is shorted to ground. If the V<sub>LOW</sub> falls below 85% of its nominal output level, then the maximum sense voltage is progressively lowered from its maximum programmed value to one-third of the maximum value. Foldback current limiting is enabled during soft-start. Under short-circuit conditions with very low duty cycles, the LTC3871 will begin cycle skipping in order to limit the short-circuit current. In this situation the bottom MOSFET will be dissipating most of the power but less than in normal operation. The short circuit ripple current is determined by the minimum on-time t<sub>ON(MIN)</sub> of the LTC3871, the V<sub>HIGH</sub> voltage and inductor value:

$$\Delta I_{L(SC)} = t_{ON(MIN)} \cdot \frac{V_{HIGH}}{L}$$

The resulting short-circuit current is:

$$I_{SC} = \left( \frac{1/3 V_{SENSE(MAX)}}{R_{SENSE}} - \frac{1}{2} \Delta I_{L(SC)} \right)$$

After a short, or while starting up, make sure that the load current takes the folded-back current limit into account.

### Phase-Locked Loop and Frequency Synchronization

The LTC3871 has a phase-locked loop (PLL) comprised of an internal voltage-controlled oscillator (VCO) and a phase detector. This allows the turn-on of the top MOSFET to be locked to the rising edge of an external clock signal applied to the SYNC pin. The phase detector is an edge sensitive digital type that provides zero degrees phase shift between the external and internal oscillators. This type of phase detector does not exhibit false lock to harmonics of the external clock.

The output of the phase detector is a pair of complementary current sources that charge or discharge the internal filter network. There is a precision 20μA current flowing out of the FREQ pin. This allows the user to use a single resistor to SGND to set the switching frequency when no external clock is applied to the SYNC pin. The internal switch between the FREQ pin and the integrated PLL filter network is on, allowing the filter network to be pre-charged at the same voltage as of the FREQ pin. The relationship between the voltage on the FREQ pin and operating frequency is shown in Figure 7 and specified in the Electrical Characteristics table. If an external clock is detected on the SYNC pin, the internal switch mentioned above turns off and isolates the influence of the FREQ pin. Note that the LTC3871 can only be synchronized to an external clock whose frequency is within range of the LTC3871's internal VCO. A simplified block diagram is shown in Figure 8.

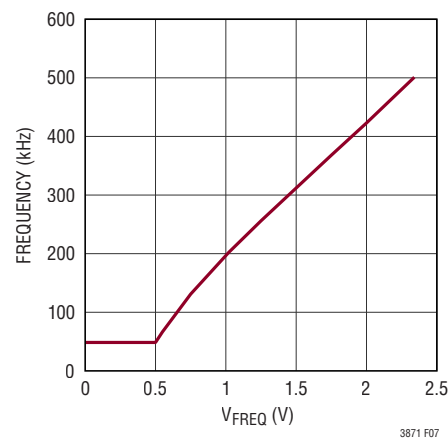

Figure 7. Relationship Between Oscillator Frequency and Voltage at the FREQ Pin

3871f