



Chipsmall Limited consists of a professional team with an average of over 10 year of expertise in the distribution of electronic components. Based in Hongkong, we have already established firm and mutual-benefit business relationships with customers from,Europe,America and south Asia,supplying obsolete and hard-to-find components to meet their specific needs.

With the principle of “Quality Parts,Customers Priority,Honest Operation,and Considerate Service”,our business mainly focus on the distribution of electronic components. Line cards we deal with include Microchip,ALPS,ROHM,Xilinx,Pulse,ON,Everlight and Freescale. Main products comprise IC,Modules,Potentiometer,IC Socket,Relay,Connector.Our parts cover such applications as commercial,industrial, and automotives areas.

We are looking forward to setting up business relationship with you and hope to provide you with the best service and solution. Let us make a better world for our industry!



Contact us

Tel: +86-755-8981 8866 Fax: +86-755-8427 6832

Email & Skype: info@chipsmall.com Web: www.chipsmall.com

Address: A1208, Overseas Decoration Building, #122 Zhenhua RD., Futian, Shenzhen, China



60V Synchronous Buck Multi-Chemistry Battery Charger

FEATURES

- **Wide Input Voltage Range: 4.5V to 60V**
- **Wide Battery Voltage Range: 2.4V to 60V**
- **Built-In Charge Algorithms for Lead-Acid and Li-Ion**
- **±0.5% Float Voltage Accuracy**
- **±5% Charge Current Accuracy**
- Maximum Power Point Tracking Input Control
- NTC Temperature Compensated Float Voltage
- Two Open Drain Status Pins
- Thermally Enhanced 28-Lead 4mm × 5mm QFN Package

APPLICATIONS

- Battery Backup for Lighting, UPS Systems, Security Cameras, Computer Control Panels
- Portable Medical Equipment
- Solar-Powered Systems
- Industrial Battery Charging

All registered trademarks and trademarks are the property of their respective owners. All other trademarks are the property of their respective owners. Protected by U.S. Patents, including 9246383.

DESCRIPTION

The **LTC®4013** is a high voltage battery charger that is well suited for charging a wide range of lead-acid batteries including both vented and sealed types. It supports bulk, float, absorption and equalization charging. The LTC4013 also supports termination options for Li-Ion/Polymer and LiFePO₄ batteries.

Charging is performed with a high efficiency synchronous buck (step-down) converter that uses external N-channel MOSFETs. Switching frequency is resistor programmable or can be synchronized to an external clock. Charge current is programmed with an external sense resistor.

The LTC4013 also includes maximum power point tracking input-voltage regulation for limited power sources such as solar panels. Other features include user-programmable absorption and equalization times, temperature-compensated charge voltage and an external N-channel MOSFET isolation control circuit.

TYPICAL APPLICATION

15V-34V to 6 Cell Lead-Acid (12.6V) 5A Step-Down Battery Charger

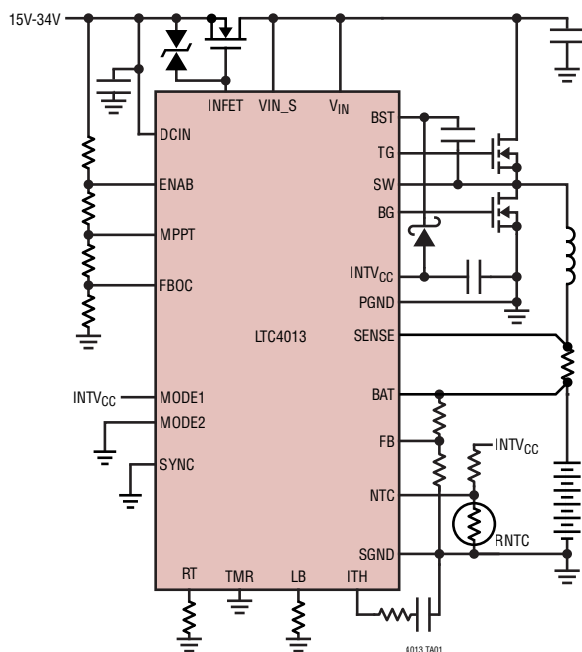

Efficiency and Power Loss vs Charge Current

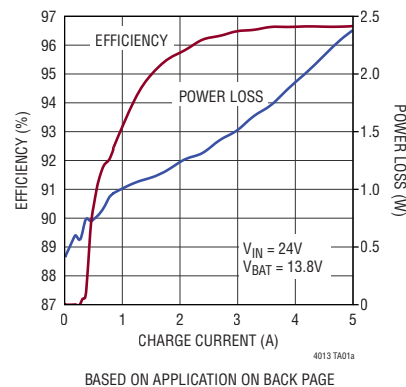

LTC4013

ABSOLUTE MAXIMUM RATINGS

(Note 1)

DCIN, V _{IN} , VIN_S, ENAB, STAT0, STAT1	-0.3V to 60V
INFET	-0.3V to 73V
BST	-0.3V to 66V
STAT0, STAT1	5mA
SENSE, BAT	-0.3V to 60V
SENSE-BAT	-0.3V to 0.3V
FBOC, MPPT, FB, MODE1, MODE2, SYNC, INTV _{CC} , NTC	-0.3V to 6V
TMR, LB, ITH	-0.3V to 3V
Operating Junction Temperature Range (Note 2)	-40°C to 125°C
Storage Temperature Range	-65°C to 150°C

PIN CONFIGURATION

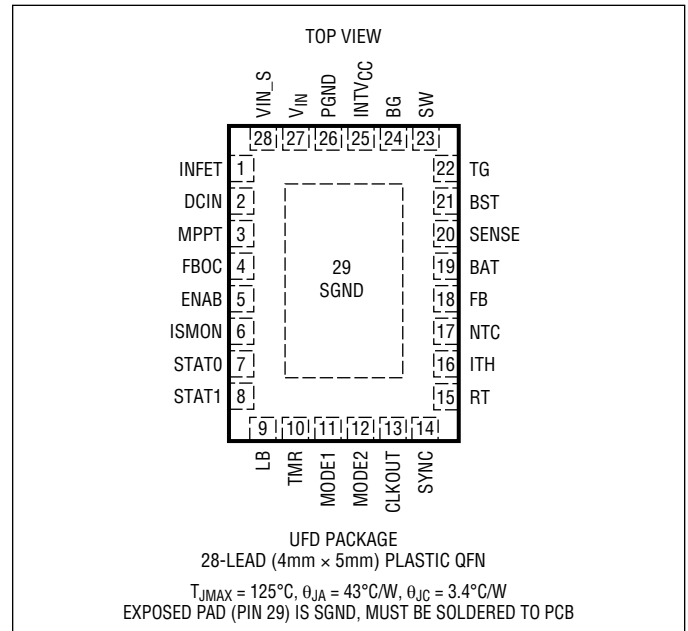

ORDER INFORMATION <http://www.linear.com/product/LTC4013#orderinfo>

LEAD FREE FINISH	TAPE AND REEL	PART MARKING	PACKAGE DESCRIPTION	TEMPERATURE RANGE
LTC4013EUFD#PBF	LTC4013EUFD#TRPBF	4013	28-Lead (4mm × 5mm) Plastic QFN	-40°C to 125°C
LTC4013IUFD#PBF	LTC4013IUFD#TRPBF	4013	28-Lead (4mm × 5mm) Plastic QFN	-40°C to 125°C

Consult LTC Marketing for parts specified with wider operating temperature ranges.

For more information on lead free part marking, go to: <http://www.linear.com/leadfree/>

For more information on tape and reel specifications, go to: <http://www.linear.com/tapeandreel/>. Some packages are available in 500 unit reels through designated sales channels with #TRMPBF suffix.

ELECTRICAL CHARACTERISTICS The ● denotes the specifications which apply over the specified operating junction temperature range, otherwise specifications are at $T_A = 25^\circ\text{C}$ (Note 2). DCIN , V_{IN} , $V_{\text{IN_S}} = 18\text{V}$, $\text{ENAB} = 1.4\text{V}$, $\text{SYNC} = 0\text{V}$ unless otherwise noted.

PARAMETER		CONDITIONS	MIN	TYP	MAX	UNITS	
Input Voltage Range (DCIN , V_{IN})		●	4.5		60	V	
Battery Voltage Range (BAT)		●	2.4		60	V	
ENAB Pin Threshold (Rising)		●	1.175	1.220	1.275	V	
Threshold Hysteresis				170		mV	
ENAB Pin Bias Current				10		nA	
V_{IN} UVLO		V_{IN} Rising, Power Enabled		3.45		V	
		V_{IN} Rising, Power Disabled		3.08		V	
DCIN Pin	Operating Current	Not Switching		480	625	μA	
	Shutdown Current	$\text{ENAB} = 0\text{V}$	●	4	7.9	μA	
V_{IN} Pin	Operating Current	Not Switching (Notes 3 and 4)		2.1	2.8	mA	
	Shutdown Current	$\text{ENAB} = 0\text{V}$, $\text{RT} = 40.2\text{k}$	●	32	80	μA	
BAT Pin	Operating Current	Not Switching		6.2	9.3	μA	
	Shutdown Current	$\text{ENAB} = 0\text{V}$	●	0.5	1.5	μA	
SENSE Pin	Operating Current	Not Switching		5.3	8.1	μA	
	Shutdown Current	$\text{ENAB} = 0\text{V}$	●	0.4	2.5	μA	
SW Pin Current in Shutdown		$\text{ENAB} = 0\text{V}$, $\text{SW} = 60\text{V}$, $\text{BST} = 66\text{V}$		0.25		μA	
STAT0, STAT1 Enabled Voltage		STAT0, STAT1 Pin Current = 1mA		0.14	0.2	V	
		STAT0, STAT1 Pin Current = 5mA		0.77	1.0	V	
STAT0, STAT1 Leakage Current		STAT0, STAT1 Pin Voltage = 60V	●		1	μA	
FB Regulation Voltage (See Tables 2-5)							
Battery Float Voltage $V_{\text{FB(FL)}}$		MODE1 = L, H MODE2 = L, H	●	2.256	2.267	2.278	V
				2.244	2.267	2.291	V
		MODE1 = M, MODE2 = L, H	●	2.189	2.200	2.211	V
				2.178	2.200	2.223	V
Battery Absorption Voltage $V_{\text{FB(ABS)}}$		MODE1 = L, MODE2 = M	●	2.320	2.332	2.344	V
				2.309	2.332	2.356	V
		MODE1 = H, MODE2 = L, H	●	2.355	2.367	2.380	V
		MODE1 = L, MODE2 = H	●	2.343	2.367	2.392	V
Battery Equalization Voltage $V_{\text{FB(EQ)}}$		MODE1 = M, MODE2 = L, H	●	2.388	2.400	2.412	V
				2.376	2.400	2.425	V
		MODE1 = L, H, MODE2 = H, TMR = Cap	●	2.487	2.500	2.513	V
				2.475	2.500	2.526	V
Battery Charge Voltage $V_{\text{FB(CHG)}}$		MODE1 = M, MODE2 = H, TMR = Cap	●	2.587	2.600	2.613	V
				2.574	2.600	2.627	V
		MODE1 = H, MODE2 = M	●	2.355	2.367	2.38	V
				2.343	2.367	2.392	V
Battery Recharge Voltage $V_{\text{FB(RECHG)}}$		MODE1 = M, MODE2 = M	●	2.388	2.400	2.412	V
				2.376	2.400	2.425	V
		MODE1 = M, H MODE2 = M	●	2.284	2.295	2.306	V
				2.272	2.295	2.319	V
NTC Amplifier Gain		$\Delta V_{\text{FB(FL)}}/\Delta V_{\text{NTC}}$		0.21		V/V	
NTC Amplifier Offset		$\Delta V_{\text{FB(FL)}}$ with $V_{\text{NTC}} = \text{INTV}_{\text{CC}}/2$		-15	0	15	mV
FB Pin Current		$V_{\text{FB}} = 3\text{V}$		10		nA	
LB Pin Current		$V_{\text{LB}} = 2\text{V}$		19.6	20	20.4	μA

ELECTRICAL CHARACTERISTICS

The ● denotes the specifications which apply over the specified operating junction temperature range, otherwise specifications are at $T_A = 25^\circ\text{C}$ (Note 2). DCIN , V_{IN} , $V_{\text{IN_S}} = 18\text{V}$, $\text{ENAB} = 1.4\text{V}$, $\text{SYNC} = 0\text{V}$ unless otherwise noted.

PARAMETER	CONDITIONS	MIN	TYP	MAX	UNITS	
Error Amp						
Error Amp Transconductance	$\Delta I_{\text{ITH}}/\Delta(V_{\text{SENSE}} - V_{\text{BAT}})$ $V_{\text{ITH}} = 1.8\text{V}$	1300	1800	2300	μmho	
Error Amp Current Source	$V_{\text{ITH}} = 1.8\text{V}$, $V_{\text{FB}} = 2.0\text{V}$, (Float) MODE1 = H, MODE2 = L	-6.5	-10	-13.5	μA	
Error Amp Current Sink	$V_{\text{ITH}} = 1.8\text{V}$, $V_{\text{FB}} = 2.4\text{V}$, (Float) MODE1 = H, MODE2 = L	18	27	35	μA	
Current Sense (all measured as $V_{\text{SENSE}} - V_{\text{BAT}}$ unless otherwise noted)						
Maximum Charging Sense Resistor Voltage	In Absorption, Float, Li-Ion Charge, BAT = 14V	●	48	50	52	mV
Equalization and Low Battery Charging Sense Resistor Voltage	BAT = 14V	●	8	10	12.5	mV
Current Sense C/10 Threshold	Termination when TMR = 0	●	2.0	4.6	7.0	mV
Constant Voltage (CV) Threshold	$V_{\text{FB(ABS,EQ)}} - V_{\text{FB}}$, Timeout Initiation with Cap on TMR	●		15.6	24.5	mV
Overcurrent Charging Turnoff		●		100	106	mV
ISMON Fullscale Output Voltage	$V_{\text{SENSE}} - V_{\text{BAT}} = 50\text{mV}$			1.00		V
SENSE Input UVLO	V_{SENSE} Rising (Charging Enabled)	●	1.86	1.97	2.07	V
SENSE Input UVLO Hysteresis	V_{SENSE} Rising to Falling (Charging Disabled)			100		mV
Configuration Pins						
MODE1, MODE2 Pin, Low Threshold		●			0.8	V
MODE1, MODE2 Pin, Mid Threshold		●	1.3		1.8	V
MODE1, MODE2 Pin, High Threshold		●	2.5			V
Timer						
TMR Oscillator High Threshold				1.5		V
TMR Oscillator Low Threshold				0.97		V
Safety Timer Turn on Voltage	TMR Voltage Rising	●	0.45	0.5	0.65	V
Safety Timer Turn on Hysteresis Voltage				250		mV
TMR Source/Sink Current	TMR = 1.25V		8.5	10.0	11.5	μA
TMR Pin Period	CTMR = 0.2 μF			20.8		ms
End of Charge Termination Time, t_{EOC}	CTMR = 0.2 μF			3.03		hr
Equalization Charge Termination Time	CTMR = 0.2 μF , MODE1 = M, H CTMR = 0.2 μF , MODE1 = L			0.379 0.758		hr hr
INTV_{CC} Regulator (INTV_{CC} Pin)						
INTV _{CC} Regulation Voltage				5.00		V
INTV _{CC} Dropout Voltage	DCIN = 4.5V, INTV _{CC} = 5mA			4.46		V
INTV _{CC} Supply Short-Circuit Current	INTV _{CC} = 0V		100	175		mA
NMOS FET Drivers						
Non-Overlap Time TG to BG				40		ns
Non-Overlap Time BG to TG				74		ns
Minimum On-Time BG				38		ns
Minimum On-Time TG				37		ns
Minimum Off-Time BG				65		ns
Top Gate Driver Switch On Resistance	BST – SW = 5V, Pull Up BST – SW = 5V, Pull Down			2.3 1.3		Ω Ω
Bottom Gate Driver Switch On Resistance	INTV _{CC} = 5V, Pull Up INTV _{CC} = 5V, Pull Down			2.3 1		Ω Ω

ELECTRICAL CHARACTERISTICS

The ● denotes the specifications which apply over the specified operating junction temperature range, otherwise specifications are at $T_A = 25^\circ\text{C}$ (Note 2). DCIN , V_{IN} , $V_{\text{IN_S}} = 18\text{V}$, $\text{ENAB} = 1.4\text{V}$, $\text{SYNC} = 0\text{V}$, unless otherwise noted.

PARAMETER	CONDITIONS		MIN	TYP	MAX	UNITS
BST UVLO	TG Enabled (Rising)			4.25		V
	TG Disabled (Falling)			3.81		V
OSC						
Switching Frequency	$R_T = 40.2\text{k}\Omega$	●	950	1000	1050	kHz
	$R_T = 232\text{k}\Omega$			200		kHz
SYNC Pin Threshold (Falling Edge)			1.3	1.4	1.5	V
SYNC Pin Hysteresis				190		mV
CLK Output Logic Level	High		4.5			V
	Low				0.5	V
Input PowerPath Control						
Reverse Turn-Off Threshold Voltage	$\text{DCIN} - V_{\text{IN}}$	●	-7.3	-4.4	-1.3	mV
Forward Turn-On Threshold Voltage	$\text{DCIN} - V_{\text{IN}}$	●	-7.1	-4.2	-1.1	mV
Forward Turn-On Hysteresis Voltage	$\text{DCIN} - V_{\text{IN}}$			0.2		mV
INFET Turn-Off Current	$\text{INFET} = V_{\text{IN}} + 1.5\text{V}$			-9.0		mA
INFET Turn-On Current	$\text{INFET} = V_{\text{IN}} + 1.5\text{V}$			60		μA
INFET Clamp Voltage	$I_{\text{INFET}} = 2\mu\text{A}$, $\text{DCIN} = 12\text{V}$ to 60V $V_{\text{IN}} = \text{DCIN} - 0.1\text{V}$ Measure $V_{\text{INFET}} - \text{DCIN}$	●		11.0	12.5	V
INFET Off Voltage	$I_{\text{INFET}} = -2\mu\text{A}$, $\text{DCIN} = 12\text{V}$ to 59.9V $V_{\text{IN}} = \text{DCIN} + 0.1\text{V}$ Measure $V_{\text{INFET}} - \text{DCIN}$	●		-2.2	-1.6	V
DCIN to BAT UVLO	Switching Regulator Turn Off ($V_{\text{DCIN}} - V_{\text{BAT}}$ Falling)			69		mV
	Switching Regulator Turn On ($V_{\text{DCIN}} - V_{\text{BAT}}$ Rising)			99		mV
MPPT Regulation						
FBOC Voltage Range		●	1.0		3.0	V
MPPT Sample Period				10.2		s
MPPT Sample Pulse Width				271		μs
Regulation Input Offset	Set FBOC Look at MPPT Regulation		-40		40	mV
MPPT Input Burst Mode Turn On Threshold	$V_{\text{MPPT}} - V_{\text{FBOC}}$ (Converted), $V_{\text{FBOC}} = 1.5\text{V}$ $V_{\text{SENSE}} - V_{\text{BAT}} < C/10$ Part Enter Burst Mode	●	-45	-32	-15	mV
MPPT Input Burst Mode Hysteresis	$\text{FBOC} = 1.5\text{V}$, $V_{\text{SENSE}} - V_{\text{BAT}} < C/10$ MPPT Turn Off – Turn On	●	35	62	85	mV

Note 1. Stresses beyond those listed under Absolute Maximum Ratings may cause permanent damage to the device. Exposure to any Absolute Maximum Rating condition for extended periods may affect device reliability and lifetime.

Note 2. The LTC4013 is tested under pulse loaded conditions such that $T_J \approx T_A$. The LTC4013E is guaranteed to meet performance specifications from 0°C to 85°C junction temperature. Specifications over the -40°C to 125°C operating junction temperature range are assured by design, characterization and correlation with statistical process controls. The LTC4013I is guaranteed over the full -40°C to 125°C operating junction temperature range. The junction temperature (T_J in $^\circ\text{C}$) is calculated from the ambient temperature (T_A in $^\circ\text{C}$) and power dissipation (P_D in Watts) according to the formula: $T_J = T_A + P_D \cdot \theta_{JA}$ where θ_{JA} (in $^\circ\text{C}/\text{W}$) is the package thermal impedance. Note that the maximum ambient

temperature consistent with these specifications is determined by specific operating conditions in conjunction with board layout, the rated package thermal resistance and other environmental factors. This IC includes over temperature protection that is intended to protect the device during momentary overload. Junction temperature will exceed 125°C when over temperature protection is active. Continuous operation above the specified maximum operating junction temperature may impair device reliability.

Note 3. V_{IN} does not include switching currents.

Note 4. I_{VIN} current also includes current that charges capacitance on CLKOUT. This current is approximately $C_{\text{CLKOUT}} \cdot 5\text{V} \cdot f_{\text{SW}}$. For this test C_{CLKOUT} was 100pF , f_{SW} was 1MHz ($R_T = 40.2\text{k}$) so the current included is 0.5mA . In normal operation the CLKOUT capacitance is much less.

TYPICAL PERFORMANCE CHARACTERISTICS $T_A = 25^\circ\text{C}$, unless otherwise noted.

Change in Absorption, Equalization, Float and Li-Ion Charge Voltages vs Temperature

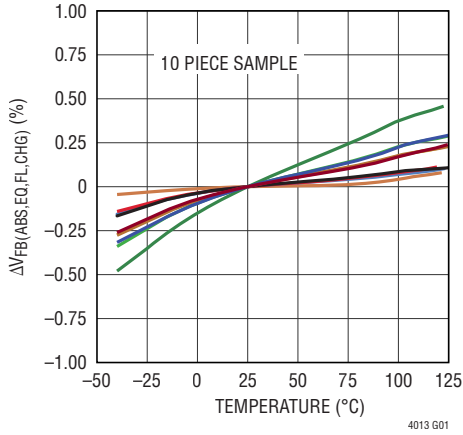

Li-Ion Recharge% vs Temperature

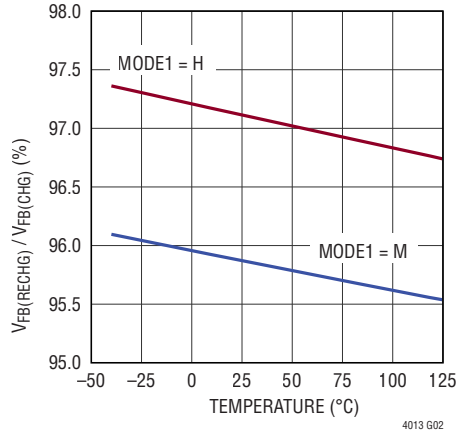

Change In Low Battery (LB) Current vs Temperature

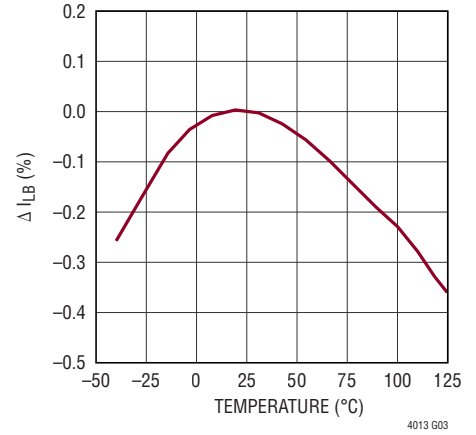

Current Sense Servo Voltage vs Temperature

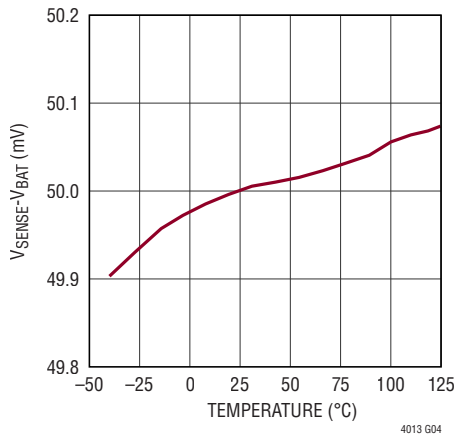

C/10 Threshold vs Temperature

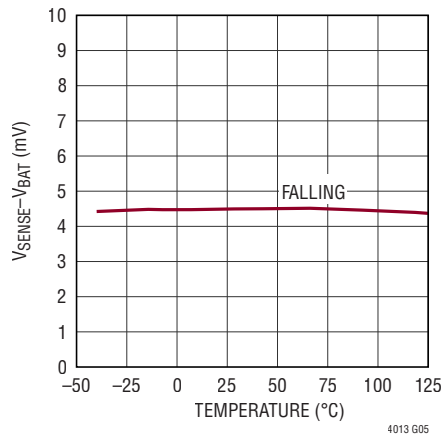

Change in ENAB Voltage vs Temperature

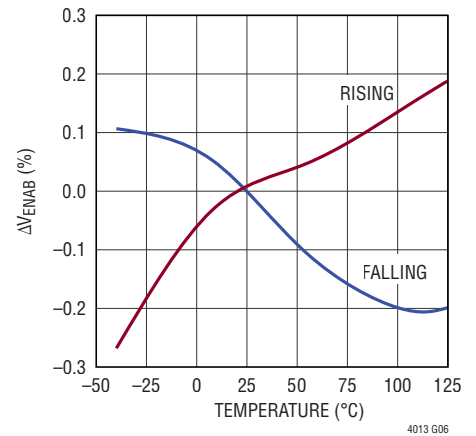

V_{IN} UVLO Voltage vs Temperature

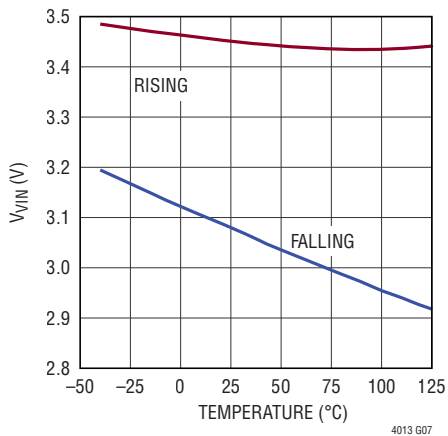

BST UVLO Voltage vs Temperature

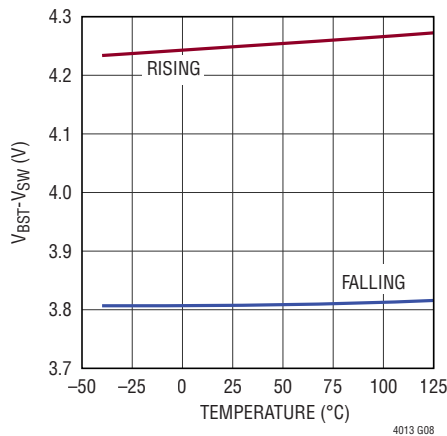

DCIN to BAT UVLO Voltage vs Temperature

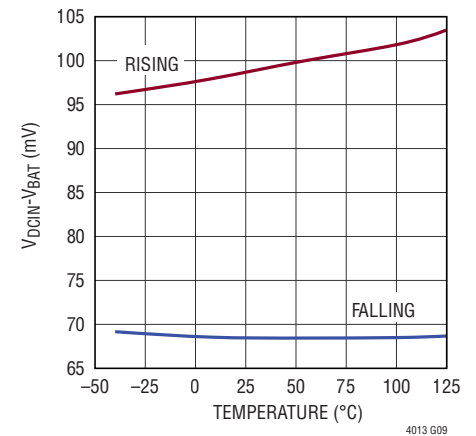

TYPICAL PERFORMANCE CHARACTERISTICS $T_A = 25^\circ\text{C}$, unless otherwise noted.

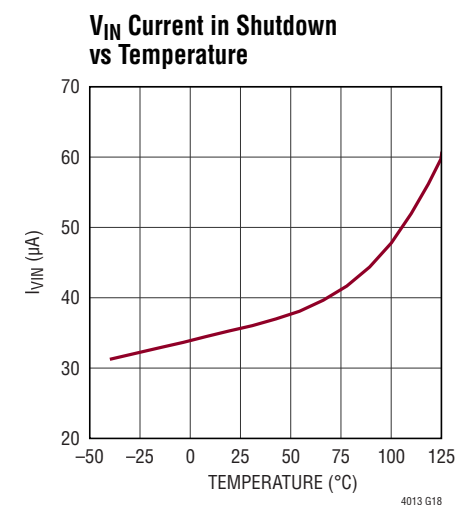
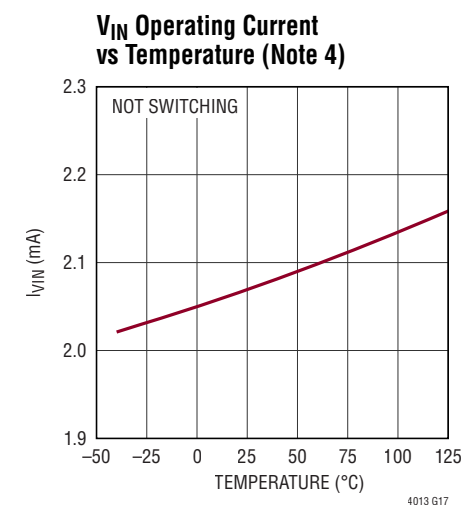
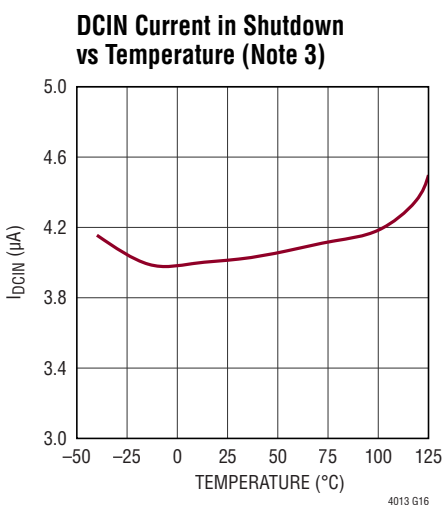
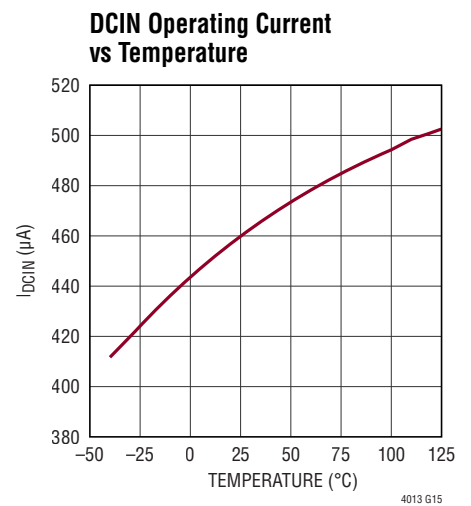
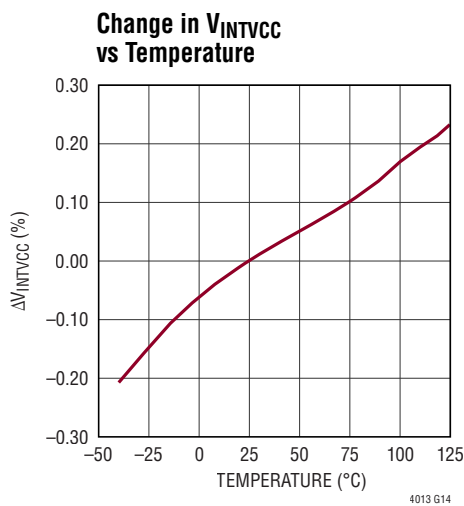
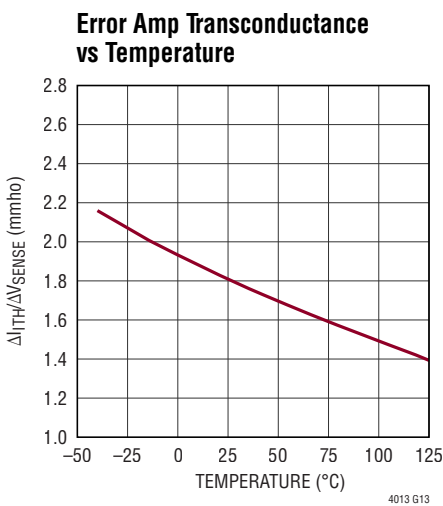
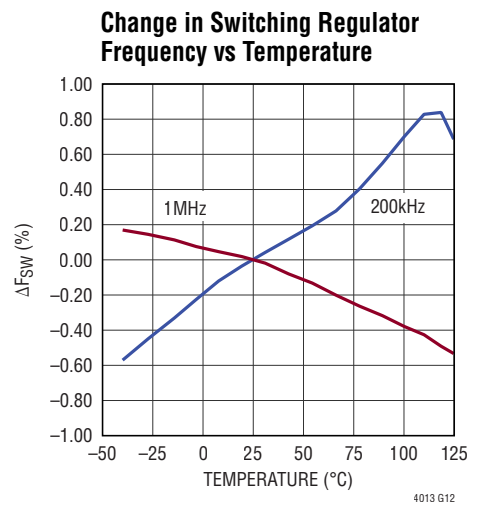
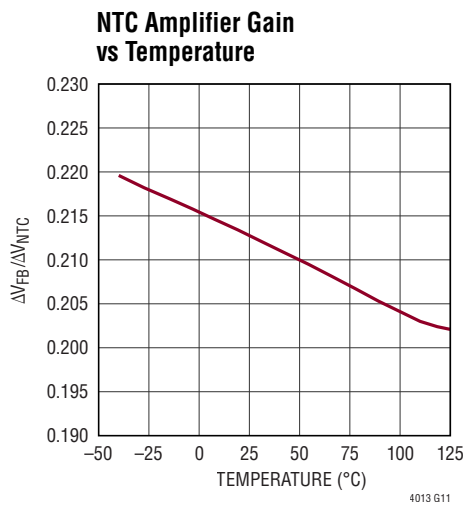
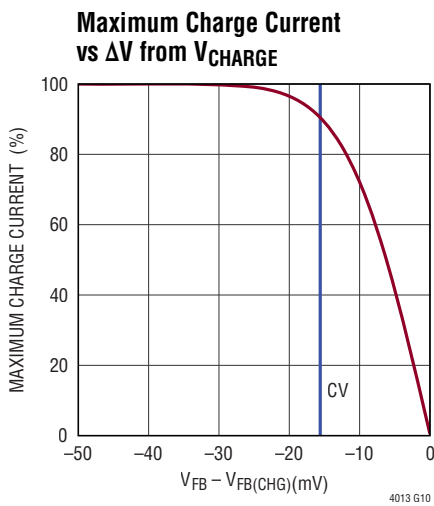

PIN FUNCTIONS

INFET (Pin 1): Input PowerPath MOSFET Gate Drive. An internal charge pump provides turn-on drive for this pin. This pin should be connected to the gate of an external N-channel MOSFET to prevent battery discharge when DCIN is less than the battery voltage.

DCIN (Pin 2): Input Supply Pin. This pin is used to sense the input voltage to determine whether to enable the INFET charge pump. It also supplies power to the INFET charge pump.

MPPT, FBOC (Pins 3, 4): Maximum Power Point Tracking (MPPT) Regulation Loop Set-Point Pins. The input voltage regulation loop regulates charge current, providing maximum power charging in the presence of a power limited source such as a solar panel. A resistor divider is placed from the input supply to MPPT, FBOC and ground. These pins are used to program the input voltage regulation loop as a percentage of the input open circuit voltage. If the input voltage falls below the programmed percentage of the open-circuit voltage, the MPPT loop will reduce charge current to maintain the target maximum power point voltage at DCIN. If the input voltage regulation feature is not used, connect FBOC to INTV_{CC}.

ENAB (Pin 5): Precision Threshold Enable Pin. The enable threshold is 1.22V (rising), with 170mV of hysteresis. In shutdown, all charging functions are disabled and input supply current is reduced.

ISMON (Pin 6): Charge Current Monitor Pin. The voltage on this pin is twenty times the differential voltage between SENSE and BAT and can be used to monitor charge current.

STAT0, STAT1 (Pins 7, 8): Open drain outputs that indicate the charger status. These pins can sink 5mA, enabling them to drive an LED. Specific states are detailed in Table 2.

LB (Pin 9): Low Battery Level Control Pin. A precision 20 μ A current sourced from LB to an external resistor sets the detection voltage for a deeply discharged battery. If FB stays below LB for 1/8 of the absorption timeout period, charging is stopped. Charging is reinitiated with an ENAB pin toggle, a power cycle or by swapping out the battery.

TMR (Pin 10): Timer Capacitor Pin. A capacitor from this pin to ground sets the time the charger spends in various charging stages. The equalization timeout is a ratio of this time, either 1/4 or 1/8 of the absorption time, depending on the MODE pins settings. The low battery timeout period is 1/8 of the absorption time.

MODE1, MODE2 (Pins 11, 12): Charge Algorithm Control Pins. See Table 1. The LTC4013 supports 2, 3 and 4-stage lead-acid as well as Li-Ion charging algorithms with and without termination. The MODE pins are tri-state and should be strapped to INTV_{CC}, ground or left floating.

CLKOUT (Pin 13): Oscillator Frequency Output Pin. This logic output is roughly 180 degrees out of phase with the switching regulator's oscillator.

SYNC (Pin 14): Frequency Synchronization Pin. This pin allows the switching frequency to be synchronized to an external clock. The R_T resistor should be chosen to operate the internal clock 20% slower than the SYNC pulse frequency. Ground SYNC when not in use.

RT (Pin 15): Switching Regulator Frequency Control Pin. A mandatory resistor from RT to ground sets the switching frequency between 200kHz and 1MHz.

ITH (Pin 16): Compensation Control Pin. This pin is used to compensate the switching regulator's constant-current control loop.

NTC (Pin 17): Thermistor Input Pin. With the use of an external NTC thermistor, the NTC pin can be used to develop a temperature dependent charge voltage for lead-acid batteries. NTC pin voltages above 3.3V disable the NTC function. The NTC function is not suitable for Lithium Ion batteries and should be disabled by strapping NTC to INTV_{CC}.

FB (Pin 18): Constant-Voltage Feedback Pin. This pin provides feedback for regulating battery voltage during the constant-voltage phase of charging. A resistor divider from the battery to this pin sets the constant-voltage charging level.

PIN FUNCTIONS

BAT, SENSE (Pins 19, 20): Charge Current Sense Pins. Battery charge current is monitored and regulated via a current sense resistor between SENSE and BAT. The constant-current servo voltage between these pins is 50mV. Overcurrent shutdown occurs when the SENSE to BAT voltage exceeds 100mV.

BST (Pin 21): High Side Gate Drive Supply Pin. BST provides a flying 5V supply for the high-side MOSFET driver. Connect a 0.22 μ F capacitor from this pin to SW. Connect a diode with its cathode to this pin and its anode to the INTV_{CC} pin.

TG (Pin 22): Top Gate Drive Pin. TG drives the gate of the top side external N-channel MOSFET.

SW (Pin 23): Switching Regulator Power Pin. SW connects to the power supply switch node which includes one side of the inductor, the source of the top side MOSFET, the drain of the bottom side MOSFET and the boost capacitor.

BG (Pin 24): Bottom Gate Drive Pin. BG drives the gate of the external bottom side N-channel MOSFET.

INTV_{CC} (Pin 25): Internal V_{CC} Pin. Powered by V_{IN}, this pin is the output of a 5V regulator that powers the internal control logic and analog circuits. Connect a ceramic capacitor from INTV_{CC} to PGND. The BST pin refresh diode anode should also be connected to INTV_{CC}.

PGND (Pin 26): Power Ground. This is the power ground for the LTC4013. It services only the BG pin drive.

V_{IN} (Pin 27): Input Supply Pin. V_{IN} provides power to the INTV_{CC} internal 5V regulator. It is usually tied to the switching regulator high side MOSFET and should be bypassed with one or more low-ESR capacitors to ground.

VIN_S (Pin 28): Input Supply Sense Input. VIN_S provides a Kelvin input for the V_{IN} connection of the input PowerPath circuitry.

SGND (Exposed Pad Pin 29): Signal Ground Reference. This pin is the quiet ground used as a reference point for critical resistor dividers such as the battery feedback divider, MPPT divider and thermistor. Connect SGND to the output decoupling capacitor negative terminal and battery negative terminal. Solder SGND to a solid ground plane through multiple vias for rated thermal performance.

BLOCK DIAGRAM

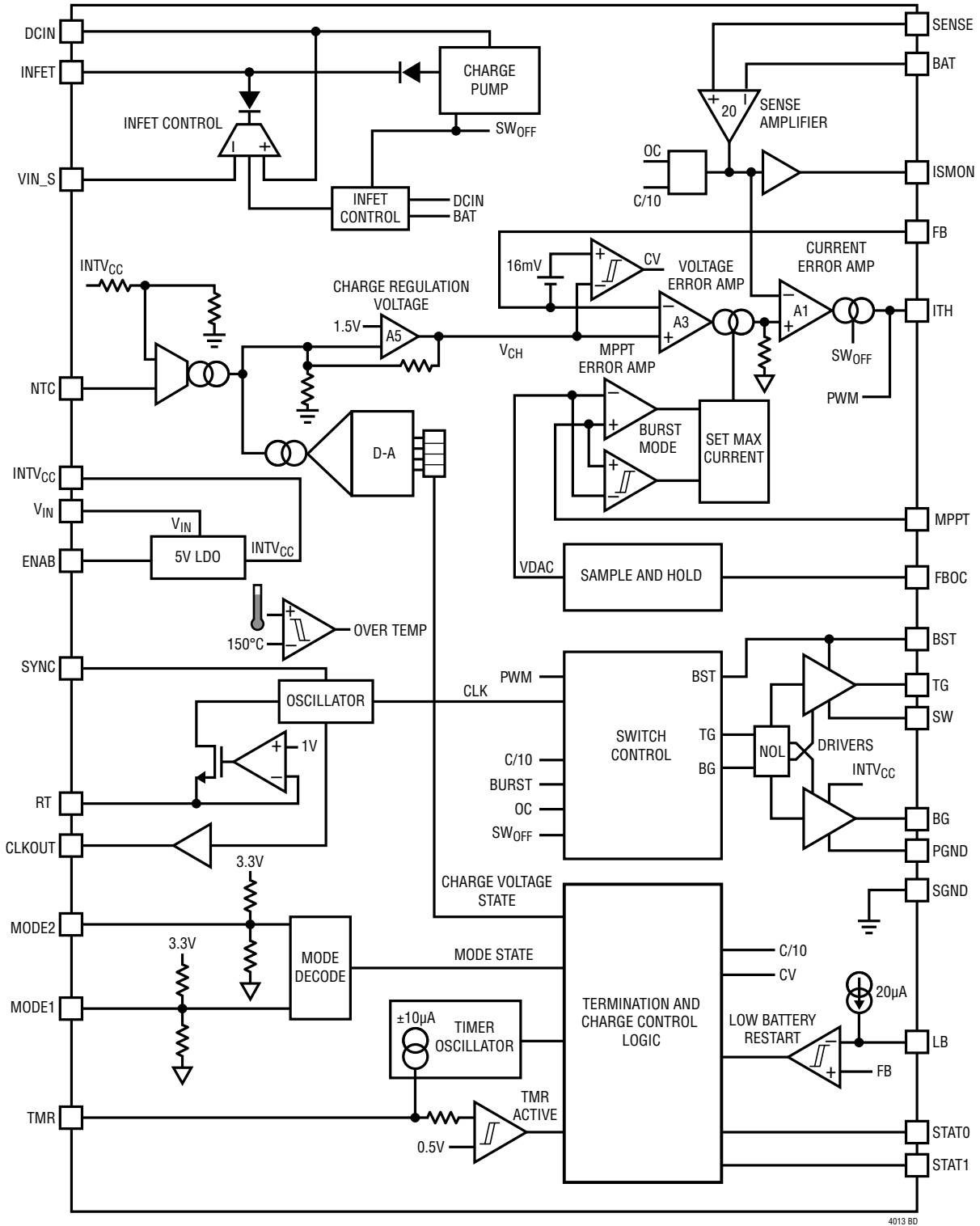

OPERATION

OVERVIEW

The LTC4013 is a high-voltage multi-chemistry battery charger with specific focus on lead-acid batteries. It incorporates a step-down (buck) DC/DC synchronous switching controller using external N-channel MOSFETS for high efficiency. It accommodates a wide range of battery voltages from 2.4V to 60V and is optimized for high current charging applications.

Selectable charger profiles are:

2-stage charging: constant-current (bulk) to constant-voltage with and without timer termination.

3-stage lead-acid charging: bulk, absorption and float with low battery restart and either charge-current (C/10) or safety-timer absorption to float transition control.

4-stage lead-acid charging: bulk, absorption, equalization, and float with low battery restart and safety-timer equalization cutoff and safety-timer absorption to float transition control.

Li-Ion constant-current to constant-voltage charging with either charge-current (C/10) or safety-timer charge termination.

DC/DC OPERATION

(See Block Diagram)

The LTC4013 uses a fixed-frequency, average current mode DC/DC converter to regulate charge current. When the battery reaches the charge voltage, current is reduced by a voltage regulation loop.

Battery current is sensed via a resistor placed between SENSE and BAT. The amplified signal is compared to a voltage that represents the maximum allowable charge current and regulates the average current by controlling the duty cycle of the output switches. The current control loop servos the differential voltage between SENSE and BAT to 50mV making $I_{CHGMAX} = 50mV/R_{SENSE}$. A frequency-compensation pin (ITH) is used to control the constant-current feedback loop stability.

At startup, the maximum current is ramped over approximately 1.6ms to provide soft start. There is an additional burst mode feature used for maximum power point transfer to facilitate low solar panel current operation.

When the battery voltage reaches the programmed charge voltage, error amplifier A3 adjusts the charge current to servo the battery voltage to the programmed level and can reduce the current to zero.

The charge voltage is determined by amplifier A5 and the charge algorithm selected. The voltage can follow a continuous function of temperature controlled by an amplifier connected to the NTC pin. A resistor divider with a thermistor sets the temperature coefficient of the voltage.

The switching regulator's oscillator frequency is set by a resistor from the RT pin to ground. The clock frequency can optionally be synchronized to an external oscillator by using the SYNC pin.

The step-down (buck) switching regulator uses external low $R_{DS(ON)}$ MOSFETs for both high and low side switches to deliver high charge current. When the current level falls below $I_{CHGMAX}/10$ the bottom MOSFET is disabled and switching operation is discontinuous with only the bottom side MOSFET body diode used for low side conduction. This diode emulation mode ensures the battery is not discharged by continuous conduction.

Supply voltage for the top gate drive is generated by a boost circuit that uses an external diode and boost capacitor charged from $INTV_{CC}$. If BST - SW is below 3.8V (e.g. at startup), the bottom side MOSFET is enabled to refresh the BST capacitor.

Solar Panel Maximum Power Point Tracking

If the MPPT function is enabled (FBOC pin voltage < 3V), the LTC4013 employs an MPPT circuit that compares a stored open-circuit input voltage measurement against the instantaneous DCIN voltage while charging. The LTC4013 then uses an input voltage sense amplifier to reduce the charge current if the DCIN voltage falls below the user

OPERATION

defined percentage of the open-circuit voltage. With this algorithm the LTC4013 optimizes power transfer for a variety of different input sources.

When MPPT is enabled, the LTC4013 periodically measures the open-circuit input voltage. About once every 10.2s the LTC4013 pauses charging, samples the input voltage as measured through a resistor divider at the FBOC pin, and reproduces this value internally with a digital-to-analog converter (DAC). When charging resumes, the DAC voltage, V_{DAC} , is compared against the MPPT pin voltage that is programmed with a resistor divider. If the MPPT voltage falls below V_{DAC} , charge current is reduced to regulate the input voltage at that level. This regulation loop maintains the input voltage at or above a user defined level that corresponds to the peak power available from the applied source. Regular input sampling is useful, for instance, to provide first order temperature compensation of a solar panel.

The sampling time is fixed internally. Switching stops for approximately 1ms every 10.2s. There is an initial 720 μ s delay allowing DC_{IN} to rise to its open circuit voltage. During the next 300 μ s, the FBOC pin voltage is sampled and stored. The sampling of DC_{IN} is done at an extremely low duty cycle to have minimal impact on the total charge current. Figure 1 shows a picture of MPPT timing.

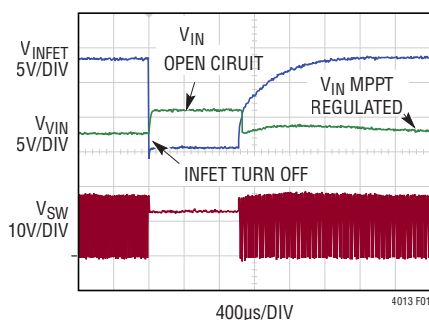

Fig 1. MPPT Timing

MPPT Burst Mode Operation

In low light, it is desirable to improve switching regulator efficiency for maximum power delivery. The LTC4013 contains proprietary circuitry that improves switching regulator efficiency during these conditions. Efficiency is improved by reducing the maximum switching regulator current and

periodically disabling the switching regulator, resulting in burst-mode operation. Burst-mode is enabled when MPPT is below the sampled FBOC voltage by approximately 32mV and the current is below $I_{CHGMAX}/10$ ($SENSE-BAT < 5mV$). The LTC4013 stays in burst-mode until the next sampling period when it is reevaluated. If MPPT is above the sampled FBOC voltage by approximately 32mV then burst-mode is disabled. The net result is that in burst-mode the DC_{IN} voltage has approximately a 64mV hysteretic ripple at the FBOC pin. During burst-mode, maximum current is set to approximately $I_{CHGMAX}/5$ ($SENSE-BAT = 10mV$).

Battery Charger Operation

There are a variety of battery chemistries and there are numerous online resources and books available for education. One good resource is www.batteryuniversity.com. Many battery manufacturers also provide detailed information.

The LTC4013 provides constant-current/constant-voltage charging. When the battery voltage is below the constant-voltage servo level, charge current is controlled by the constant-current control loop. As the battery charges, its voltage increases and eventually holds at the constant-voltage servo level whereupon charge current tapers naturally toward zero as the battery tops off.

In constant-current charging the charge current is controlled by the fixed servo voltage of 50mV divided by the external sense resistor between SENSE and BAT.

Once the battery voltage increases and the charger is in the constant-voltage charging phase, the battery charge voltage is controlled by the FB pin.

The FB voltage regulation levels are appropriate for a single-cell lead-acid battery. For instance, a 2.267V single-cell float voltage corresponds to a 6-cell battery voltage of $6 \cdot 2.267V = 13.6V$.

The LTC4013 also contains a charge cycle timer. This timer is used for the absorption to float transition in 3-stage and 4-stage lead-acid charging, equalization timeout in 4-stage lead-acid charging and constant-voltage timeout in both Li-Ion and 2-stage charging. The timer is activated by connecting a capacitor from the TMR pin to ground. Grounding TMR disables all timer functions.

OPERATION

The LB pin provides a user adjustable low battery voltage setting that sets the re-start level in 2-stage, 3-stage and 4-stage charging and the low battery fault level in Li-Ion charging. The LB pin produces a precision 20 μ A current which results in a precision voltage when a resistor is placed from LB to ground. The LB pin is compared internally to the FB pin for low battery determination.

Four possible charging algorithms can be selected by pin strapping or manipulating the MODE0 and MODE1 pins (see Table 1). These pins should be tied either low (GND), high (INTV_{CC}) or mid (floating). The charge algorithms are described below.

2-Stage Charging

2-stage charging is useful for batteries with no absorption preconditioning. Charging is initiated on input power-up whereupon the battery charges with constant-current at I_{CHGMAX} toward V_{FB(FL)}. The STAT0 pin pulls low immediately indicating that charging has begun. Once the battery terminals approach V_{FB(FL)}, the constant-voltage control loop takes over holding the battery voltage steady as the charge current naturally tapers to zero. Once the constant-voltage loop takes control, the STAT1 pin also pulls low indicating the change from constant-current to constant-voltage charging.

If a capacitor is used on the TMR pin, the charge cycle terminates after an accumulated period of t_{EOC} in constant-voltage mode at which time STAT0 and STAT1 will indicate termination by switching off. Alternately, if the TMR pin is grounded, 2-stage charging will charge forever at V_{FB(FL)} with no termination.

Charging is re-initiated from termination if the FB-referred battery voltage drops below the LB threshold voltage as set by the LB pin, or if the LTC4013 is powered off and back on by cycling the ENAB pin or input power.

Defective battery protection is enabled if the timer capacitor is used. Whenever the FB-referred battery voltage is below the LB threshold, charge current is automatically reduced to I_{CHGMAX}/5. If a defective battery remains below the low battery threshold longer than 1/8 of the timer period (t_{EOC}/8) the charge cycle terminates. A defective

battery fault is indicated by STAT0 turning off and STAT1 turning on.

There are two voltage settings available for 2-stage charging as noted in Table 1.

2-stage charging for a lead-acid battery has the disadvantage of not fully charging the battery, resulting in diminished capacity over time due to increased deposits on the electrodes.

3-Stage Charging

A more complete lead-acid battery charging method is 3-stage charging utilizing an absorption phase which increases the amount of stored charge in the battery. Because the absorption voltage is above the electrochemical float level, the time that the battery stays in this condition should be limited either by a timer (the safest method) or waiting for the charge current to diminish. Minor gassing of water from the battery can occur from charging the battery above the float voltage, so choosing an appropriate absorption voltage is important for best battery life. Always consult the battery manufacturer for their recommendations.

3-stage charging is initiated on input power-up whereupon the battery charges with constant-current at I_{CHGMAX} toward V_{FB(ABS)}. The STAT0 pin pulls low immediately indicating that charging has begun. As the battery voltage approaches V_{FB(ABS)}, charge current naturally tapers to zero. When the charge current drops to I_{CHGMAX}/10, STAT1 also pulls low and the charge voltage setting changes to the V_{FB(FL)} voltage. At this lower level, the constant-voltage control loop will "capture" and hold the battery voltage as it slowly drops from V_{FB(ABS)} down to V_{FB(FL)}.

Alternately, the transition from absorption charging to float charging can be controlled with the timer by placing a capacitor on the TMR pin. When the battery voltage reaches constant-voltage in the absorption phase, the timer begins. At the end of the accumulated timer period in constant-voltage mode at V_{FB(ABS)}, the charge voltage changes to the V_{FB(FL)} voltage and will remain there. Again, STAT1 turns on, indicating the transition from the V_{FB(ABS)} charging level to the V_{FB(FL)} charging level.

OPERATION

If a load subsequently pulls the FB-referred battery voltage below the LB pin, or if the LTC4013 is powered off and back on by cycling the ENAB pin or input power, a new 3-stage charge cycle is initiated with a new absorption phase.

Defective battery protection is enabled if the timer capacitor is used. Whenever the FB-referred battery voltage is below the LB threshold, charge current is automatically reduced to $I_{CHGMAX}/5$. If a defective battery remains below the low battery threshold longer than $1/8$ of the timer period ($t_{EOC}/8$) the charge cycle terminates. A defective battery fault is indicated by STAT0 turning off and STAT1 turning on.

There are different options for absorption and float voltages. Table 1 details the MODE pins settings and FB voltages. Figure 2 shows an example of a 3-stage charge cycle.

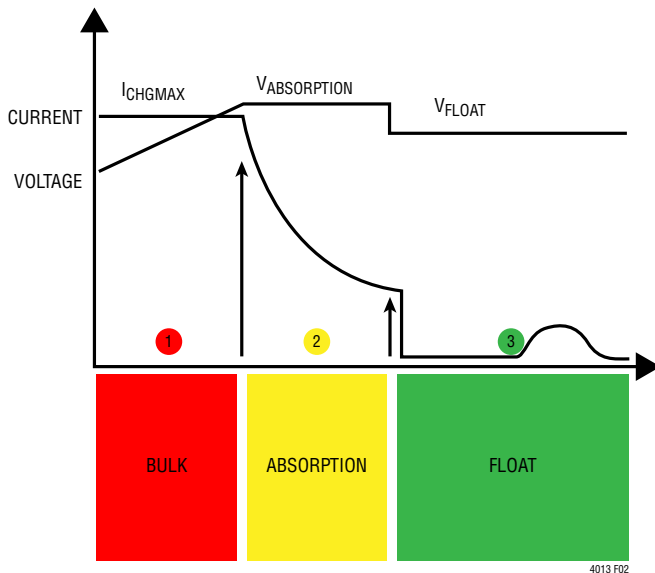

Figure 2. 3-Stage Charge Cycle

4-Stage Charging

A 4-stage charging algorithm adds an equalization phase to the 3-stage method after the absorption phase. The equalization voltage is significantly higher than the absorption voltage and works in two ways. One is to purposely

introduce gassing which stirs the battery electrolyte and reduces electrolyte stratification. Equalization also electrochemically eliminates sulfates on the electrodes which is the main cause of battery performance degradation. Sulfates typically form in heavily discharged batteries. Equalization is not done with sealed batteries because of the gassing. If lost water is not replaced, the battery will be degraded. An equalization cycle should be performed on a periodic, service-only, basis only if the manufacturer of the battery approves of the technique and should be monitored for dangerous conditions. Use of 4-stage charging is highly discouraged for solar applications as sporadic light patterns can cause multiple equalization cycles per day. Not all batteries can be charged with a 4-stage cycle so you must consult with your battery manufacturer as to its frequency of use and recommended charge voltage.

Charging is initiated on input power-up whereupon the battery charges with constant-current at I_{CHGMAX} toward $V_{FB(ABS)}$. The STAT0 pin pulls low immediately indicating that charging has begun. As the battery voltage approaches $V_{FB(ABS)}$, charge current naturally tapers to zero and the timer starts. At the end of the timer period, the charge voltage setting changes to the equalization voltage $V_{FB(EQ)}$. The timer is then restarted and the charge current setting is dropped to $I_{CHGMAX}/5$. The equalization phase continues until the end of equalization timeout, either $t_{EOC}/4$ or $t_{EOC}/8$, as programmed by the MODE pins. After the equalization timeout, the charge voltage is reduced to the $V_{FB(FL)}$ voltage and STAT1 turns on indicating the end of the charge cycle. The 4-stage cycle always requires the use of a capacitor on the TMR pin as a safety precaution to ensure that charging time at the high equalization voltage is limited. If the TMR pin is grounded, the 4-stage charge cycle will revert to 3-stage charging with no equalization phase.

The LTC4013 ensures that only one equalization phase will run per power-on cycle. After a 4-stage cycle completes, all subsequent low battery (LB) cycles will only trigger a 3-stage cycle with absorption phase and not a 4-stage cycle with equalization. Only a power-off event or ENAB pin cycle will result in a complete 4-stage equalization cycle.

OPERATION

Defective battery protection is enabled if the timer capacitor is used. Whenever the FB-referred battery voltage is below the LB threshold, charge current is automatically reduced to $I_{CHGMAX}/5$. If a defective battery remains below the low battery threshold longer than $1/8$ of the timer period ($t_{EOC}/8$) the charge cycle terminates. A defective battery fault is indicated by STAT0 turning off and STAT1 turning on.

Figure 3 shows an example of a 4-stage charge cycle.

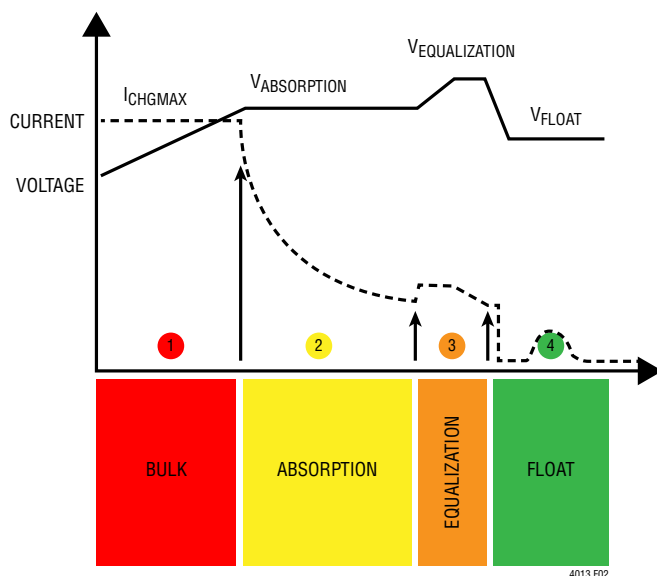

Figure 3. 4-Stage Charge Cycle

Li-Ion Charging

The LTC4013 can also charge Li-Ion batteries including Li-Polymer and LiFePO₄.

Charging is initiated on input power-up whereupon the battery charges with constant-current at I_{CHGMAX} toward $V_{FB(CHG)}$. The STAT0 pin pulls low immediately indicating that charging has begun. As the battery voltage approaches $V_{FB(CHG)}$, charge current naturally tapers to zero. The STAT1 pin also turns on indicating constant-voltage operation. There are two options for Li-Ion charge termination. If a capacitor is included on the TMR pin, the timer starts when the battery reaches the constant-voltage regulation point.

Once the timer expires (t_{EOC}), charging is terminated. Alternately, if the TMR pin is grounded, the timer is disabled and charging terminates when the charge current drops to $1/10$ of I_{CHGMAX} ($C/10$). Termination is indicated by STAT0 and STAT1 turning off.

The LTC4013 will begin charging again if the FB-referred battery voltage falls below the Lilon recharge level $V_{FB(RECHG)}$. The recharge voltage is either 97.0% or 95.6% of $V_{FB(CHG)}$ depending on the MODE pins. To avoid frequent recharge events due to voltage sag on LiFePO₄ batteries, the wider difference is recommended.

Defective battery protection is enabled if the timer capacitor is used. Whenever the FB-referred battery voltage is below the LB threshold, charge current is automatically reduced to $I_{CHGMAX}/5$. If a defective battery remains below the low battery threshold longer than $1/8$ of the timer period ($t_{EOC}/8$) the charge cycle terminates. A defective battery fault is indicated by STAT0 turning off and STAT1 turning on.

Mode Pins and Battery Charge Voltages

The LTC4013 provides several different options for setting the $V_{FB(FL)}$, $V_{FB(ABS)}$ and $V_{FB(EQ)}$ voltages. In normal mode, single-cell absorption is approximately 100mV above float (600mV for 6 cells), equalization is then approximately 133mV above absorption (800mV for 6 cells). Another option uses a wider voltage spread where single-cell absorption voltage is 200mV above float (1.2V for 6 cells) and equalization is 200mV above absorption (1.2V for 6 cells). Absolute voltages are adjusted through the FB resistor divider to gain these voltages up proportionately. It is important to consult your battery manufacturer for their suggestion on charging voltages. There is no industry consensus and it depends heavily on the type of battery and anticipated usage.

Table 1 shows the MODE0/1 pin settings to select the charge algorithm and the range of charge voltage settings for the normal and wide spread voltage modes and Table 2 shows the STAT0/1 indicator pin values in various charging states.

OPERATION

Table 1. Mode Pin Settings

Stages	Spread	MODE1	MODE2	VFLOAT	VRecharge	VAbsorb	VEqualize	TEqualize
Li-Ion	Wide	M	M	2.400V	2.295V			
Li-Ion	Normal	H	M	2.367V	2.295V			
2-Stage	n/a	L	L	2.267V				
2-Stage	n/a	L	M	2.333V				
3-Stage	Wide	M	L	2.200V		2.400V		
3-Stage	Normal	H	L	2.267V		2.367V		
4-Stage	Normal	L	H	2.267V		2.367V	2.500V	$t_{EOC}/4$
4-Stage	Normal	H	H	2.267V		2.367V	2.500V	$t_{EOC}/8$
4-Stage	Wide	M	H	2.200V		2.400V	2.600V	$t_{EOC}/8$

Table 2. Status Pin Indications

STAT0	STAT1	Li-Ion / 2-Stage	3-Stage / 4-Stage
OFF	OFF	Not Charging or Terminated	Not Charging
ON	OFF	Charging C_C	Absorb/Equalize Charging
ON	ON	Charging CV	Float Charging
OFF	ON	Low Battery or Thermal Shutdown Fault	

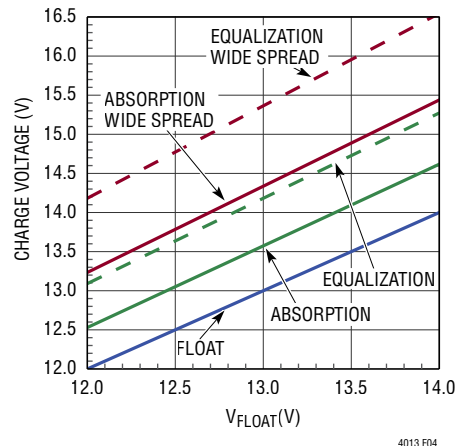
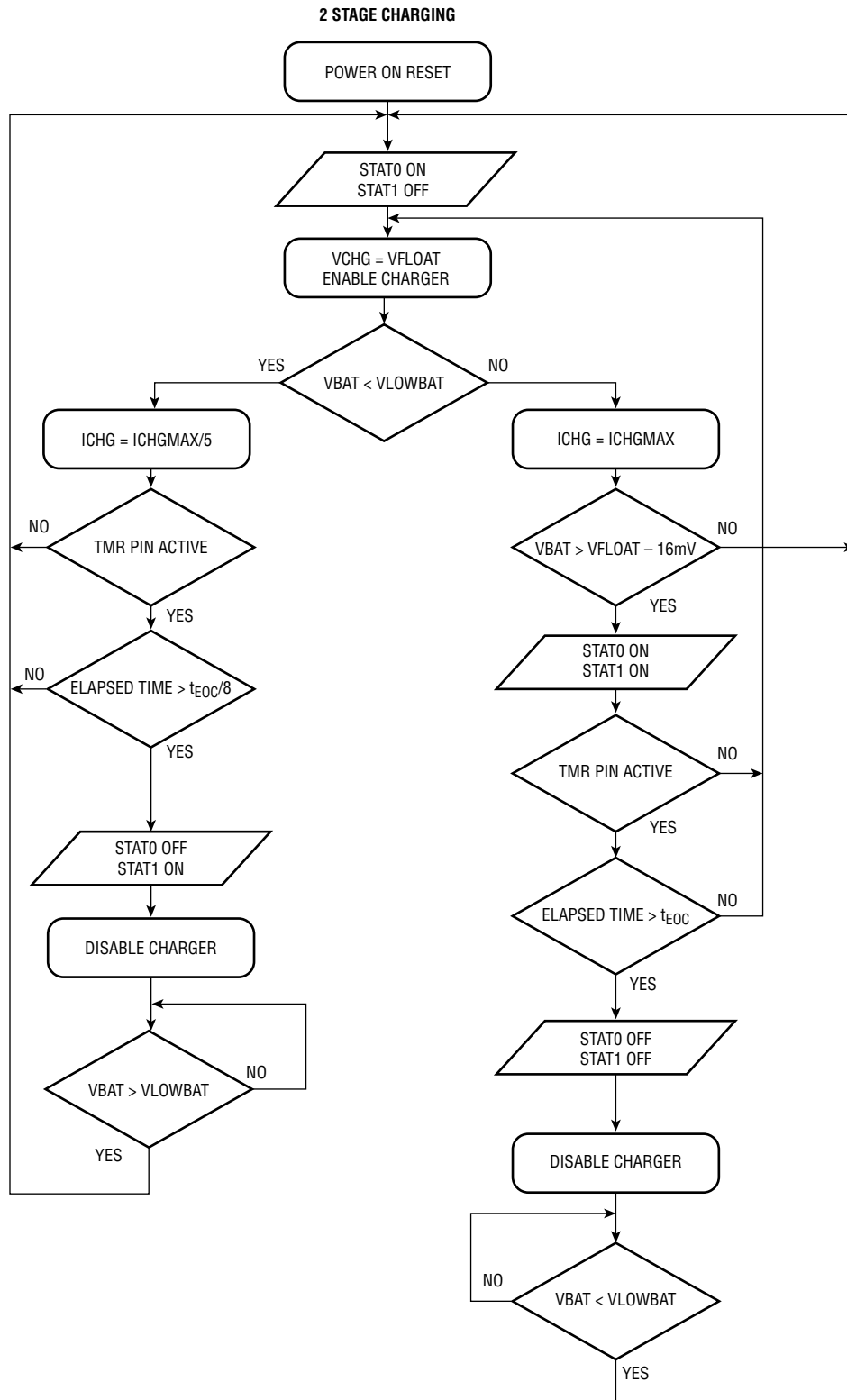

Figure 4. 6 Cell Lead-Acid Charge Voltages with R_{FB1}/R_{FB2} Change

Figure 4 shows the relationship between the float voltage, the absorption and the equalization voltages for a given feedback divider setting.

The following diagrams show the details of each charge algorithm.

OPERATION



OPERATION

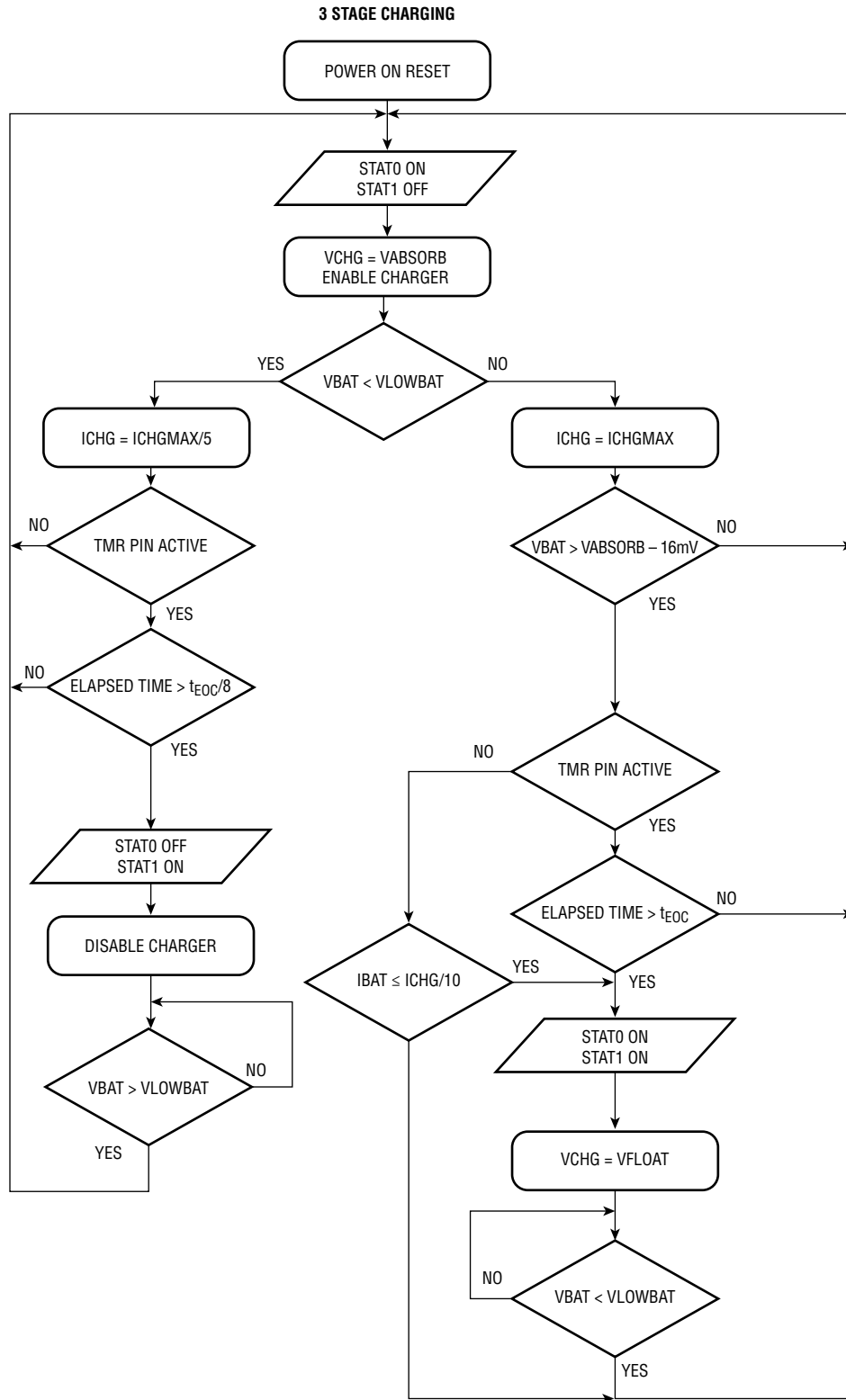

OPERATION

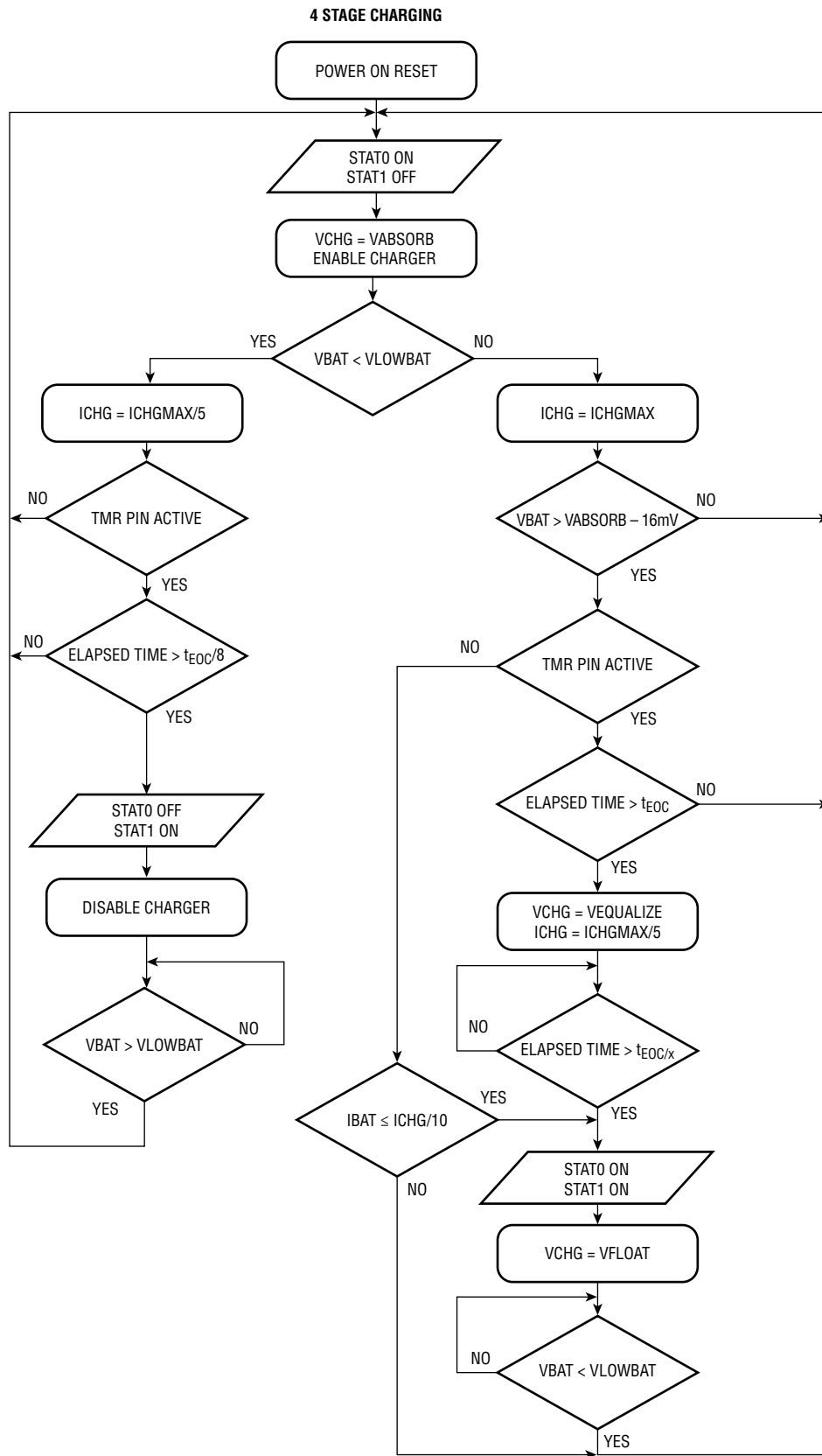

OPERATION

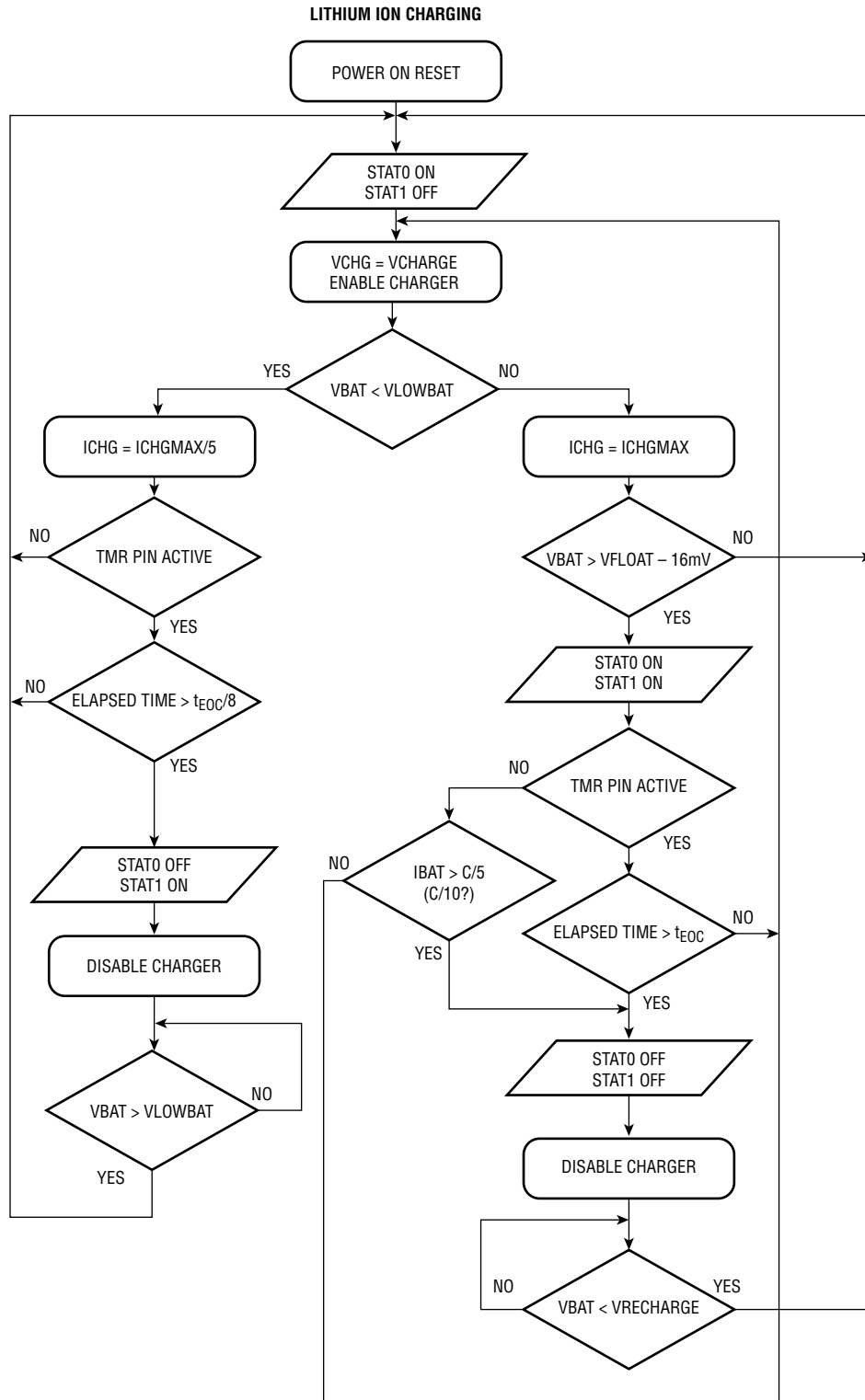

OPERATION

Charge Voltage Temperature Compensation

The LTC4013 can use a thermistor to adjust the battery charge voltage as a function of temperature. The change in FB-referred charge voltage from its nominal level is given by $\Delta V_{FB} = (V_{NTC} - V_{INTV_{CC}}/2) \cdot 0.21$. Voltages above 3.3V disable the NTC feature. The transfer function, when combined with a thermistor, is stronger than necessary. It is configured this way so that any thermistor can be diluted with a low drift resistor to achieve the desired temperature coefficient. To avoid the 3.3V NTC disable threshold, the LTC4013 requires that the dilution resistor be placed in parallel with the thermistor rather than in series. The bias resistor from $INTV_{CC}$ to NTC should be equal to the parallel combination of the thermistor at 25°C and the dilution resistor.

Figure 5 shows the NTC circuit configuration and Table 3 shows some common temperature coefficient and associated resistor settings using a 10k, $\beta = 3380K$ thermistor.

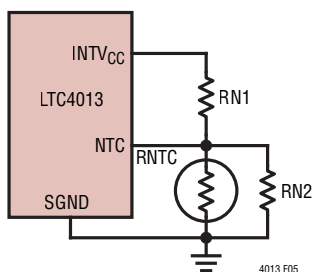

Figure 5. NTC Configuration for Temperature Compensation

Table 3. Charge Voltage TC Examples Using $\beta = 3380$ RNTC

TC (WRT V_{FB})	RN1	RN2
-2.5mV/°C	2.49k	3.32k
-5.0mV/°C	4.99k	10.0k

Figure 6 shows the diluted thermistor voltage vs temperature and Figure 7 shows the resultant charge voltage vs temperature.

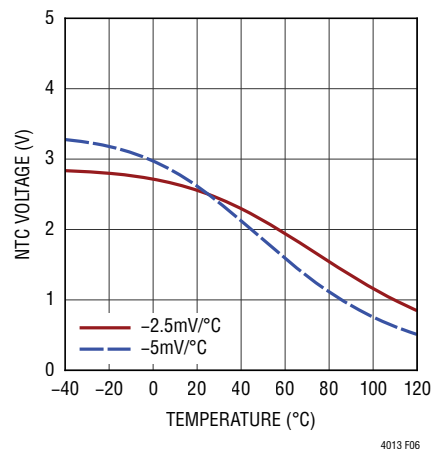

Figure 6. Diluted Thermistor Voltage vs Temperature

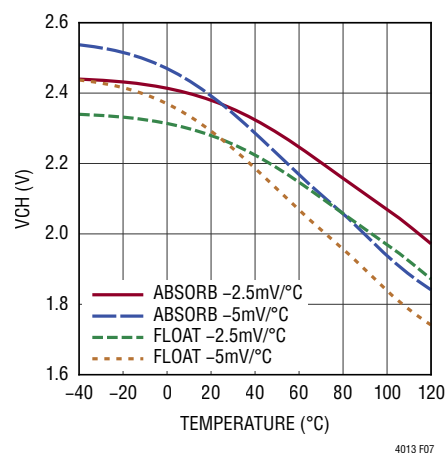

Figure 7. FB-Referred Charge Voltage vs Temperature

Since the thermistor is used to adjust charge voltage vs battery temperature, it is ideally placed in thermal contact with the battery. This is not always practical so the next best thing is to position the resistor to sense the battery's ambient temperature.

Charge Termination Timer

The LTC4013 supports timer-based functions wherein battery charge cycle control occurs after a specific amount of time. Timer termination is engaged when a capacitor (C_{TMR}) is connected from the TMR pin to ground. For a desired end-of-cycle time (t_{EOC}) C_{TMR} follows the relation:

$$C_{TMR} (\mu F) = t_{EOC} (Hr) \cdot 0.066$$

OPERATION

The absorption and Li-Ion termination timer cycles start when the charger transitions from constant-current to constant-voltage charging. Equalization timing starts immediately upon transition to the equalization charge state and low battery timing commences when FB falls below LB.

Low Battery (LB) Pin

The LB pin is used to program the low battery level and is compared internally to the FB pin voltage. The LB pin sources a very precise 20 μ A current so the threshold voltage can be programmed simply by placing a resistor from LB to ground. For instance, 100k to ground sets the LB pin to 2.0V. In 2-stage and Li-Ion charging a transition below the LB threshold triggers a new charge cycle if terminated. In 3-stage and 4-stage a transition below the LB threshold returns the charger to the absorption charging phase. In all four modes, Li-Ion, 2-stage, 3-stage and 4-stage, and with a timer capacitor present, the low battery fault timer starts and the charge current is reduced to C/5. All four modes terminate charging if the low-battery timer expires.

A commonly used low-battery voltage for a 6 cell battery is 10.4V which represents the voltage with one of 6 cells shorted. This LB voltage is set with an 86.6k resistor for 1.73V/cell, or 10.4V/6 with a 6-to-1 FB divider.

Output Current Monitoring

Charge current can be determined by observing the voltage at the ISMON pin. ISMON follows the expression:

$$ISMON = 20 \cdot (V_{SENSE} - V_{BAT}).$$

Programming Switching Frequency

The LTC4013 has an operational switching frequency range between 200kHz and 1MHz which is programmed with an external resistor from the RT pin to ground. Table 4 shows resistor values and their corresponding switching frequencies. An approximate formula is:

$$R_T(k\Omega) = \frac{40.2}{f_{SW}^{1.088} (MHz)}$$

Table 4. R_T Resistor Value

Switching Frequency	R _T (Ω)
1MHz	40.2k
750kHz	54.9k
500kHz	86.6k
300kHz	150k
200kHz	232k

Switching Frequency Synchronization

The internal oscillator may also be synchronized to an external clock through the SYNC pin. The signal applied to the SYNC pin must have a logic low below 1.3V and a logic high above 1.7V. The input sync frequency must be 20% higher than the frequency that would otherwise be determined by the resistor at the RT pin. Input signals outside of these specified parameters cause erratic switching behavior and subharmonic oscillations. When synchronizing to an external clock, be aware that there is a fixed delay from the input clock edge to the edge of the signal at the SW pin. Ground the SYNC pin if synchronization to an external clock is not required.

INFET Behavior

The LTC4013 controls an input N-Channel MOSFET via an on-chip charge pump on INFET. The MOSFET provides a blocking path to prevent battery discharge when the input voltage is below the battery voltage. It also disconnects the input supply from the charger to measure the input voltage with no load for Maximum Power Point Tracking (MPPT).

Undervoltage Lockouts

The INFET charge pump and switching regulator are enabled when all four UVLO comparators are satisfied and the ENAB pin is above its precision enable threshold. Specifically, V_{IN} must be above its absolute threshold of 3.45V, DCIN must be greater than BAT by at least 99mV and must also be within 4mV of V_{IN}. A fourth UVLO requires that the battery voltage at SENSE be above its UVLO level of approximately 1.97V.

OPERATION

If the conditions above are not met then INFET is turned off and sinks current pulling INFET to approximately 2.2V below the lower voltage of DCIN or V_{IN} . If the input voltage is more than the gate breakdown of the external transistor, a TVS diode is required to prevent the disable current or pin leakage from pulling INFET all the way to ground. For MPPT applications requiring two transistors at INFET, a conventional diode will suffice as it will pull down the common source node safely.

Thermal Shutdown

The LTC4013 has thermal shutdown that disables charging at approximately 160°C. When the LTC4013 has cooled to 150°C, charging resumes. Thermal shutdown protects the device from excessive gate drive power and excess internal LDO power dissipation but does not necessarily prevent excess power dissipation in the external MOSFETS or other external components.

APPLICATIONS INFORMATION

Setting Charge Current

Charge current, I_{CHGMAX} , is determined by the current sense resistor between SENSE and BAT. The servo voltage is 50mV making the charge current $50\text{mV}/R_{\text{SENSE}}$. For a 10A charge current R_{SENSE} should be $5\text{m}\Omega$. Accuracy requires the use of 4-terminal sense resistors or careful attention to ensure a Kelvin connection to the sense resistor. Figure 18 shows two examples. Size the resistor for power dissipation with $P_{\text{SENSE}} = I_{\text{CHGMAX}} \cdot 50\text{mV}$. For example, the 10A sense resistor needs to be at least $\frac{1}{2}\text{Watt}$. Susumu, Panasonic and Vishay offer a wide variety of accurate sense resistors.

Inductor Selection

Size the inductor so that the peak-to-peak ripple current is approximately 30% of the maximum charging current. This is a reasonable trade-off between inductor size and ripple. Inductance can be computed with the following equation:

$$L = \frac{V_{\text{IN}} \cdot V_{\text{BAT}} - V_{\text{BAT}}^2}{0.3 \cdot f_{\text{SW}} \cdot I_{\text{CHGMAX}} \cdot V_{\text{IN}}}$$

where V_{BAT} is the battery voltage, V_{IN} is the input voltage, I_{CHGMAX} is the maximum charge current and f_{SW} is the switching frequency. Choose the saturation current for the inductor to be at least 20% higher than the maximum charge current.

To protect against faults, there is an overcurrent comparator which terminates switching when the voltage between the SENSE and BAT pins exceeds 100mV. When tripped, switching is stopped for a minimum of 4 switch cycles.

Switching Regulator MOSFET Selection

Key parameters for MOSFET selection are: total gate charge (Q_{G}), on-resistance ($R_{\text{DS(ON)}}$), gate to drain charge (Q_{GD}), gate-to-source charge (Q_{GS}), gate resistance (R_{G}), breakdown voltage (maximum V_{GS} and V_{DS}) and drain current (maximum I_{D}). The following guidelines provide information to make the selection process easier. Table 5 lists some recommended manufacturers.

The rated drain current for both MOSFETs must be greater than the maximum inductor current. Peak inductor current is approximately:

$$I_{\text{LMAX}} = I_{\text{CHGMAX}} + \frac{V_{\text{IN}} \cdot V_{\text{BAT}} - V_{\text{BAT}}^2}{2 \cdot f_{\text{SW}} \cdot L \cdot V_{\text{IN}}}$$

The rated drain current is temperature dependent, and most data sheets include a table or graph of rated drain current versus temperature.

The rated V_{DS} must be higher than the maximum input voltage (including transients) for both MOSFETs.

The LTC4013 will drive the gates of the switching MOSFETs with about 5V (INTV_{CC}) with respect to their sources. However, during start-up and recovery conditions, the gate drive signals may be as low as 3V. Therefore, to ensure that the LTC4013 operates properly, use logic level threshold MOSFETs with a V_{T} of about 2V or less. For a robust design, ensure that the rated maximum V_{GS} is at least 7V.

Power loss in the switching MOSFETs is related to the on-resistance, $R_{\text{DS(ON)}}$; gate resistance, R_{G} ; gate-to-drain charge, Q_{GD} and gate-to-source charge, Q_{GS} . Power lost to the on-resistance is an ohmic loss, $I^2 R_{\text{DS(ON)}}$, and usually dominates for input voltages less than 15V. Power lost while charging the gate capacitance typically dominates for voltages greater than 15V. When operating at higher input voltages, efficiency is optimized by selecting a high side MOSFET with higher $R_{\text{DS(ON)}}$ and lower Q_{G} . The total power loss in the high side MOSFET is approximated by the sum of ohmic losses and transition losses:

$$P_{\text{HIGH_LOSS}} = \frac{V_{\text{BAT}}}{V_{\text{IN}}} \cdot I_{\text{L}}^2 \cdot R_{\text{DS(ON)}} \cdot \rho_{\text{T}} +$$

$$\frac{V_{\text{IN}} \cdot I_{\text{L}}}{5\text{V}} \cdot (Q_{\text{GD}} + Q_{\text{GS}}) \cdot (2 \cdot R_{\text{G}} + R_{\text{PU}} + R_{\text{PD}}) \cdot f_{\text{SW}}$$

ρ_{T} is a dimensionless temperature dependent factor in the MOSFET's on-resistance. Using 70°C as the maximum ambient operating temperature, ρ_{T} is roughly equal to 1.3. RPD and RPU are the LTC4013 high side gate driver output impedances: 2.3Ω and 1.3Ω , respectively.

APPLICATIONS INFORMATION

For the low side MOSFET the power loss is approximated by:

$$P_{\text{LOW_LOSS}} = \left(1 - \frac{V_{\text{BAT}}}{V_{\text{IN}}}\right) \cdot I_{\text{L}}^2 \cdot R_{\text{DS(ON)}} \cdot \rho_{\text{T}} + \frac{V_{\text{IN}} \cdot I_{\text{L}}}{5\text{V}} \cdot (Q_{\text{GD}} + Q_{\text{GS}}) \cdot (2 \cdot R_{\text{G}} + R_{\text{PU}} + R_{\text{PD}}) \cdot f_{\text{SW}} + V_{\text{f}} \cdot 2 \cdot f_{\text{SW}} \cdot I_{\text{L}} \cdot t_{\text{noL}}$$

Where V_{f} is the voltage drop of the lower MOSFET bulk diode, typically 0.7V, and t_{noL} is the non-overlap time, approximately 50ns. The last term in this expression represents the loss due to the body diode that is active during the non-overlap time.

In addition to the above requirements, it is desirable for the bottom MOSFET to have lower gate-drain capacitance as it minimizes coupling to BGATE when the SW pin rises. This coupling may momentarily turn on the bottom side MOSFET creating shoot-through that, at best, reduces efficiency and at worst can destroy the MOSFET.

While it is possible to get high and low side MOSFETs bonded in a common package, excessive power dissipation may require two separate packages or even that multiple high or low side MOSFETs be used at the high-power levels. Using multiple packages spreads the heat over a larger PCB area improving overall board temperature and efficiency.

At lower V_{IN} , the top side MOSFET is on longer and low $R_{\text{DS(ON)}}$ helps lower dissipation but at higher input voltage the transient losses increase and can dominate. For the bottom side MOSFET the opposite is true. Optimization for best efficiency suggests different top and bottom MOSFETs.

A good approach to MOSFET sizing is to select the high side MOSFET first, then the low side MOSFET. The trade-off between $R_{\text{DS(ON)}}$, Q_{G} , and Q_{GS} for the high side MOSFET is evident in the following example of charging a 6 cell lead-acid battery from a 30V source at 20A. V_{BAT} is equal to 14V, $f_{\text{SW}} = 200\text{kHz}$.

For the top side MOSFET the BSC018N04LS is a suitable 40V N-channel MOSFETs with an $R_{\text{DS(ON)}}$ of $2.0\text{m}\Omega$ at 4.5V, $Q_{\text{G}} = 60\text{nC}$, $Q_{\text{GS}} = 25\text{nC}$, $Q_{\text{GD}} = 10\text{nC}$, $R_{\text{G}} = 1.3\Omega$. The bottom side MOSFET is a BSC093N04LS with an $R_{\text{DS(ON)}}$ of $11.0\text{m}\Omega$ at 4.5V, $Q_{\text{G}} = 8.6\text{nC}$, $Q_{\text{GS}} = 4.9\text{nC}$, $Q_{\text{GD}} = 2\text{nC}$, $R_{\text{G}} = 1.0\Omega$. Power loss for the MOSFETs is shown in Figures 8 and 9. Observe that the total power loss at 30V is just over 5W for the top switch and about 4W for the bottom switch.

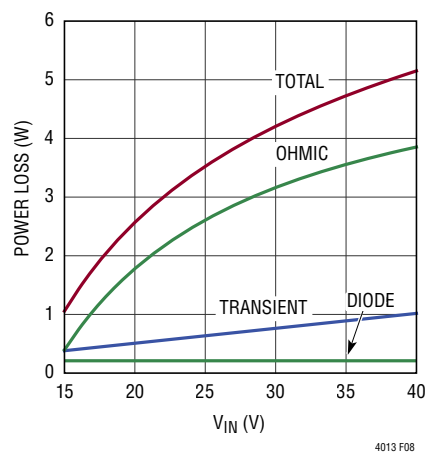

Figure 8. Bottom MOSFET Power Loss Example

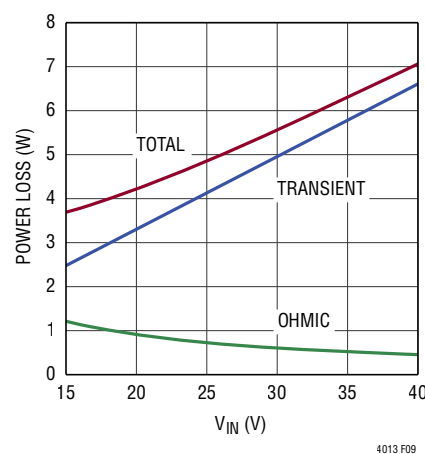

Figure 9. Top MOSFET Power Loss Example