



Chipsmall Limited consists of a professional team with an average of over 10 year of expertise in the distribution of electronic components. Based in Hongkong, we have already established firm and mutual-benefit business relationships with customers from,Europe,America and south Asia,supplying obsolete and hard-to-find components to meet their specific needs.

With the principle of “Quality Parts,Customers Priority,Honest Operation,and Considerate Service”,our business mainly focus on the distribution of electronic components. Line cards we deal with include Microchip,ALPS,ROHM,Xilinx,Pulse,ON,Everlight and Freescale. Main products comprise IC,Modules,Potentiometer,IC Socket,Relay,Connector.Our parts cover such applications as commercial,industrial, and automotives areas.

We are looking forward to setting up business relationship with you and hope to provide you with the best service and solution. Let us make a better world for our industry!



## Contact us

Tel: +86-755-8981 8866 Fax: +86-755-8427 6832

Email & Skype: info@chipsmall.com Web: www.chipsmall.com

Address: A1208, Overseas Decoration Building, #122 Zhenhua RD., Futian, Shenzhen, China



## FEATURES

- Charges Single-Cell Li-Ion Battery from Wall Adapter and USB Inputs
- Automatic Input Detection (DC Input has Charging Priority)
- Charge Current Programmable up to 1.2A from Wall Adapter Input
- C/X Charge Current Termination
- Input Power Present Output (PWR) with 120mA Drive Capability
- Independent DC, USB Charge Current Programming
- Preset Float Voltage with  $\pm 0.6\%$  Accuracy
- Thermal Regulation Maximizes Charge Rate Without Risk of Overheating\*
- Charge Status Output
- Automatic Recharge
- 20 $\mu$ A Charger Quiescent Current in Shutdown
- Available in a Thermally Enhanced, Low Profile (0.75mm) 10-Lead (3mm  $\times$  3mm) DFN Package

## APPLICATIONS

- Cellular Telephones
- MP3 Players
- Portable Handheld Devices

## DESCRIPTION

The LTC<sup>®</sup>4096/LTC4096X are standalone linear chargers that are capable of charging a single-cell Li-Ion or Li-Polymer battery from both wall adapter and USB inputs. The chargers can detect power at the inputs and automatically select the appropriate power source for charging.

No external sense resistor or blocking diode is required for charging due to the internal MOSFET architecture. Internal thermal feedback regulates the battery charge current to maintain a constant die temperature during high power operation or high ambient temperature conditions. The float voltage is fixed at 4.2V and the charge current is programmed with an external resistor. The LTC4096 terminates the charge cycle when the charge current drops below the user programmed termination threshold after the final float voltage is reached. The LTC4096 can be put into shutdown mode reducing the DCIN supply current to 20 $\mu$ A, the USBIN supply current to 10 $\mu$ A, and the battery drain current to less than 2 $\mu$ A even with power applied to both inputs.

Other features include trickle charge (LTC4096 only), automatic recharge, undervoltage lockout, charge status output and power present output with 120mA drive capability.

LTC, LTC and LT are registered trademarks of Linear Technology Corporation. All other trademarks are the property of their respective owners. \*Protected by U.S. Patents including 6522118.

## TYPICAL APPLICATION

Dual Input Battery Charger for Single-Cell Li-Ion Battery

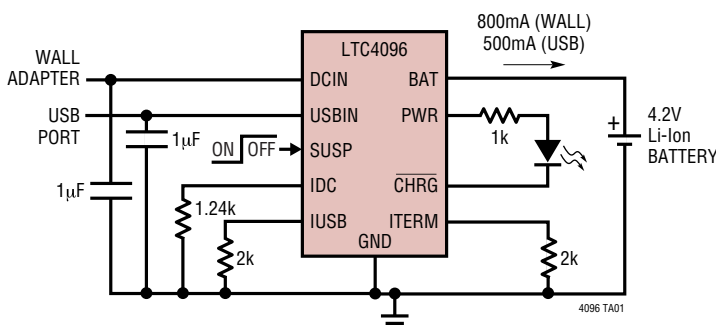

Complete Charge Cycle (1100mAh Battery)

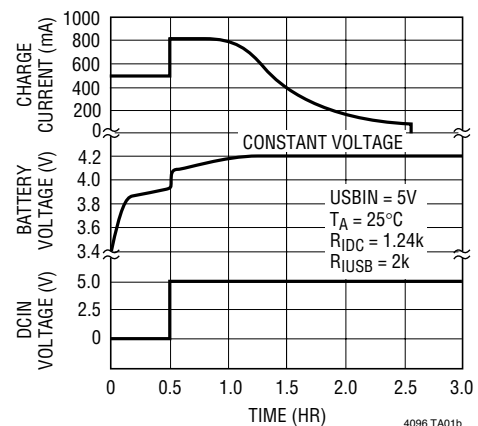



# LTC4096/LTC4096X

## ABSOLUTE MAXIMUM RATINGS

(Note 1,7)

$V_{DCIN}, V_{USBIN}$	
$t < 1\text{ms}$ and Duty Cycle $< 1\%$ .....	-0.3V to 7V
Steady State .....	-0.3V to 6V
BAT, CHR $\bar{G}$ , SUSP .....	-0.3V to 6V
IDC, IUSB, ITERM .....	-0.3V to VCC + 0.3V
BAT Short-Circuit Duration .....	Continuous
PWR Short-Circuit Duration .....	Continuous
BAT, DCIN Pin Current (Note 6) .....	1.25A
USBIN Pin Current (Note 6) .....	1.1A
IDC, IUSB, ITERM Pin Current .....	1.25mA
Junction Temperature .....	125°C
Operating Temperature Range (Note 2) ...	-40°C to 85°C
Storage Temperature Range .....	-65°C to 125°C

## PACKAGE/ORDER INFORMATION

TOP VIEW

DD PACKAGE  
10-LEAD (3mm × 3mm) PLASTIC DFN  
 $T_{JMAX} = 125^{\circ}\text{C}$ ,  $\theta_{JA} = 40^{\circ}\text{C}/\text{W}$  (Note 3)  
EXPOSED PAD (PIN 11) IS GND, MUST BE SOLDERED TO PCB

ORDER PART NUMBER	DD PART MARKING
LTC4096EDD	LCSJ
LTC4096XEDD	LCLM

**Order Options** Tape and Reel: Add #TR  
Lead Free: Add #PBF Lead Free Tape and Reel: Add #TRPBF  
Lead Free Part Marking: <http://www.linear.com/leadfree/>

Consult LTC Marketing for parts specified with wider operating temperature ranges.

## ELECTRICAL CHARACTERISTICS

The ● denotes the specifications which apply over the full operating temperature range, otherwise specifications are at  $T_A = 25^{\circ}\text{C}$ .  $V_{DCIN} = 5\text{V}$ ,  $V_{USBIN} = 5\text{V}$ ,  $R_{IDC} = 1\text{k}\Omega$ ,  $R_{IUSB} = 2\text{k}\Omega$ ,  $R_{ITERM} = 2\text{k}\Omega$  unless otherwise noted.

SYMBOL	PARAMETER	CONDITIONS	MIN	TYP	MAX	UNITS	
$V_{DCIN}$	Adapter Supply Voltage	●	4.25		5.5	V	
$V_{USBIN}$	USB Supply Voltage	●	4.25		5.5	V	
$I_{DCIN}$	DCIN Supply Current	Charge Mode (Note 4), $R_{IDC} = 10\text{k}$	●	250	800	$\mu\text{A}$	
		Standby Mode; Charge Terminated	●	50	100	$\mu\text{A}$	
		Shutdown Mode (SUSP = 5V)		20	40	$\mu\text{A}$	
$I_{USBIN}$	USBIN Supply Current	Charge Mode (Note 5), $R_{IUSB} = 10\text{k}$ , $V_{DCIN} = 0\text{V}$	●	250	800	$\mu\text{A}$	
		Standby Mode; Charge Terminated, $V_{DCIN} = 0\text{V}$	●	50	100	$\mu\text{A}$	
		Shutdown ( $V_{DCIN} = 0\text{V}$ , SUSP = 5V)		20	40	$\mu\text{A}$	
		$V_{DCIN} > V_{USBIN}$		10	20	$\mu\text{A}$	
$V_{FLOAT}$	Regulated Output (Float) Voltage	$I_{BAT} = 1\text{mA}$	4.179	4.2	4.221	V	
		$I_{BAT} = 1\text{mA}$ , $0^{\circ}\text{C} \leq T_A \leq 85^{\circ}\text{C}$	4.158	4.2	4.242	V	
$I_{BAT}$	BAT Pin Current	$R_{IDC} = 1.25\text{k}$ , Constant-Current Mode		750	800	850	mA
		$R_{IUSB} = 2.1\text{k}$ , Constant-Current Mode		450	476	500	mA
		$R_{IDC} = 10\text{k}$ or $R_{IUSB} = 10\text{k}$		88	100	112	mA
		Standby Mode, Charge Terminated			-5	-8	$\mu\text{A}$
		Shutdown Mode (Charger Disabled)			-2	-4	$\mu\text{A}$
		Sleep Mode ( $V_{DCIN} = 0\text{V}$ , $V_{USBIN} = 0\text{V}$ )			-5	-8	$\mu\text{A}$
$V_{IDC}$	IDC Pin Regulated Voltage	Constant-Current Mode, $R_{IDC} = 1.25\text{k}$		1		V	
$V_{IUSB}$	IUSB Pin Regulated Voltage	Constant-Current Mode, $R_{IUSB} = 2\text{k}$		1		V	

4096xf

## ELECTRICAL CHARACTERISTICS

The ● denotes the specifications which apply over the full operating temperature range, otherwise specifications are at  $T_A = 25^\circ\text{C}$ .  $V_{\text{DCIN}} = 5\text{V}$ ,  $V_{\text{USBIN}} = 5\text{V}$ ,  $R_{\text{IDC}} = 1\text{k}\Omega$ ,  $R_{\text{IUSB}} = 2\text{k}\Omega$ ,  $R_{\text{ITERM}} = 2\text{k}\Omega$  unless otherwise noted.

SYMBOL	PARAMETER	CONDITIONS	MIN	TYP	MAX	UNITS
$I_{\text{TERMINATE}}$	Charge Current Termination Threshold	$R_{\text{ITERM}} = 1\text{k}$	88	100	112	mA
		$R_{\text{ITERM}} = 2\text{k}$	42	50	58	mA
		$R_{\text{ITERM}} = 10\text{k}$	6	9.5	13	mA
$I_{\text{TRIKL}}$	Trickle Charge Current (LTC4096 Only)	$V_{\text{BAT}} < V_{\text{TRIKL}}$ ; $R_{\text{IDC}} = 1\text{k}$	85	100	115	mA
		$V_{\text{BAT}} < V_{\text{TRIKL}}$ ; $R_{\text{IUSB}} = 2\text{k}$	42	50	58	mA
$V_{\text{TRIKL}}$	Trickle Charge Threshold Voltage (LTC4096 Only)	$V_{\text{BAT}}$ Rising Hysteresis	● 2.8	2.9 135	3	V mV
$V_{\text{UVDC}}$	DCIN Undervoltage Lockout Voltage	From Low to High Hysteresis	4	4.22 200	4.4	V mV
$V_{\text{UVUSB}}$	USBIN Undervoltage Lockout Voltage	From Low to High Hysteresis	3.8	4 200	4.2	V mV
$V_{\text{ASD-DC}}$	$V_{\text{DCIN}} - V_{\text{BAT}}$ Lockout Threshold Voltage	$V_{\text{DCIN}}$ from High to Low, $V_{\text{BAT}} = 4.3\text{V}$	5	30	55	mV
		$V_{\text{DCIN}}$ from Low to High, $V_{\text{BAT}} = 4.3\text{V}$		100		mV
$V_{\text{ASD-USB}}$	$V_{\text{USBIN}} - V_{\text{BAT}}$ Lockout Threshold Voltage	$V_{\text{USBIN}}$ from High to Low, $V_{\text{BAT}} = 4.3\text{V}$	5	30	55	mV
		$V_{\text{USBIN}}$ from Low to High, $V_{\text{BAT}} = 4.3\text{V}$		150		mV
$V_{\text{SUSP}}$	$V_{\text{IL}}$ , Logic Low Voltage				0.5	V
	$V_{\text{IH}}$ , Logic High Voltage		1.2			V
$R_{\text{SUSP}}$	SUSP Pulldown Resistance		● 1.3	3.4	7	M $\Omega$
$V_{\text{CHRG}}$	CHRG Output Low Voltage	$I_{\text{CHRG}} = 5\text{mA}$		● 62	150	mV
$\Delta V_{\text{RECHRG}}$	Recharge Battery Threshold Voltage	$V_{\text{FLOAT}} - V_{\text{RECHRG}}$	30	50	80	mV
$t_{\text{RECHRG}}$	Recharge Comparator Filter Time	$V_{\text{BAT}}$ from High to Low		1.6		ms
$t_{\text{TERMINATE}}$	Termination Comparator Filter Time	$I_{\text{BAT}}$ Drops Below Termination Threshold		3		ms
$R_{\text{ON-DC}}$	Power FET "ON" Resistance (Between DCIN and BAT)			420		m $\Omega$
$R_{\text{ON-USB}}$	Power FET "ON" Resistance (Between USBIN and BAT)			470		m $\Omega$
$R_{\text{DC-PWR}}$	Power FET "ON" Resistance (Between DCIN and PWR)	$V_{\text{DCIN}} = 5\text{V}$ , $V_{\text{USBIN}} = 0\text{V}$		15		$\Omega$
$R_{\text{USB-PWR}}$	Power FET "ON" Resistance (Between USBIN and PWR)	$V_{\text{DCIN}} = 0\text{V}$ , $V_{\text{USBIN}} = 5\text{V}$		6.6		$\Omega$
$T_{\text{LIM}}$	Junction Temperature in Constant-Temperature Mode			115		$^\circ\text{C}$

**Note 1:** Stresses beyond those listed under Absolute Maximum Ratings may cause permanent damage to the device. Exposure to any Absolute Maximum Rating condition for extended periods may affect device reliability and lifetime.

**Note 2:** The LTC4096 is guaranteed to meet the performance specifications from  $0^\circ\text{C}$  to  $85^\circ\text{C}$ . Specifications over the  $-40^\circ\text{C}$  to  $85^\circ\text{C}$  operating temperature range are assured by design, characterization and correlation with statistical process controls.

**Note 3:** Failure to correctly solder the Exposed Pad of the package to the PC board will result in a thermal resistance much higher than  $40^\circ\text{C}/\text{W}$ . See Thermal Considerations.

**Note 4:** Supply current includes  $I_{\text{DC}}$  and  $I_{\text{TERM}}$  pin current (approximately  $100\mu\text{A}$  each) but does not include any current delivered to the battery through the BAT pin.

**Note 5:** Supply current includes  $I_{\text{USB}}$  and  $I_{\text{TERM}}$  pin current (approximately  $100\mu\text{A}$  each) but does not include any current delivered to the battery through the BAT pin.

**Note 6:** Guaranteed by long term current density limitations.

**Note 7:**  $V_{\text{CC}}$  is greater of DCIN or USBIN

## TYPICAL PERFORMANCE CHARACTERISTICS $T_A = 25^\circ\text{C}$ , unless otherwise noted.

**Battery Regulated Output (Float)  
Voltage vs Charge Current**

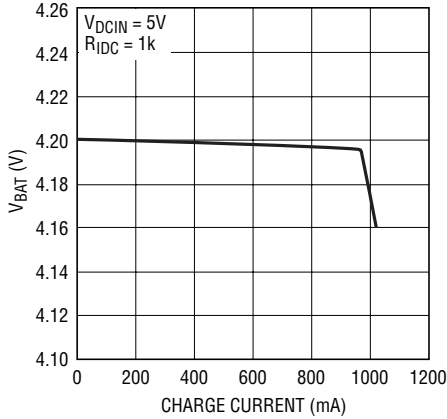

**Battery Regulated Output (Float)  
Voltage vs Charge Current**

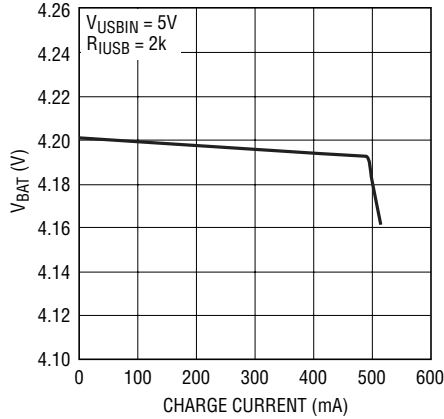

**Battery Regulated Output (Float)  
Voltage vs Temperature**

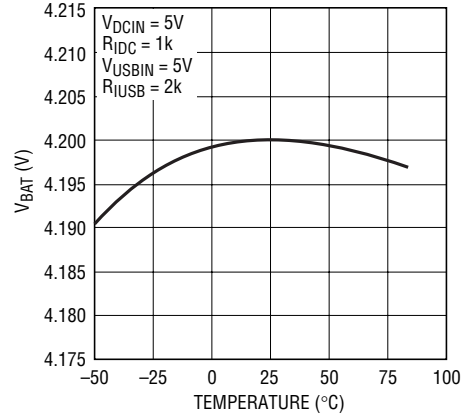

**Battery Regulated Output (Float)  
Voltage vs DCIN Voltage**

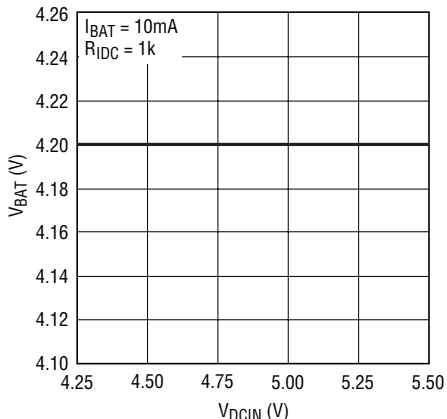

**Battery Regulated Output (Float)  
Voltage vs USBIN Voltage**

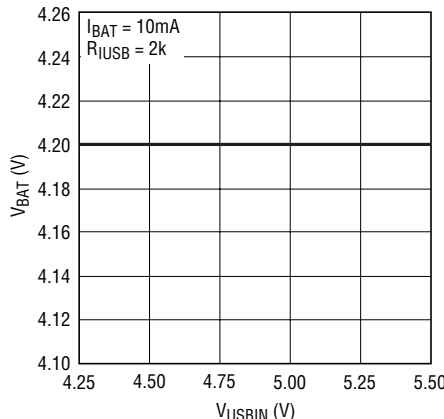

**Charge Current vs IDC Pin  
Voltage**

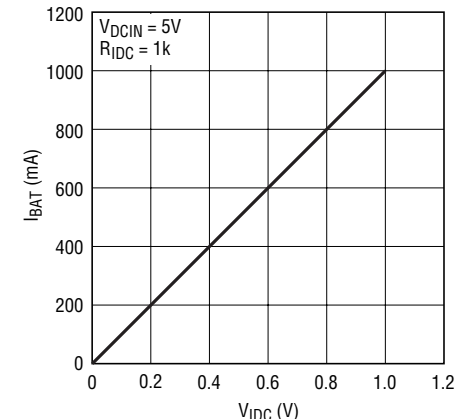

**Charge Current vs IUSB Pin  
Voltage**

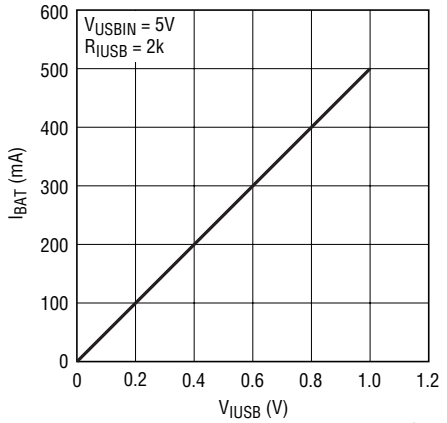

**IDC Pin Voltage vs Temperature  
(Constant-Current Mode)**

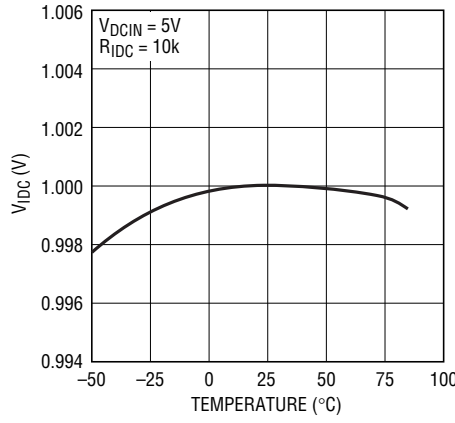

**IUSB Pin Voltage vs Temperature  
(Constant-Current Mode)**

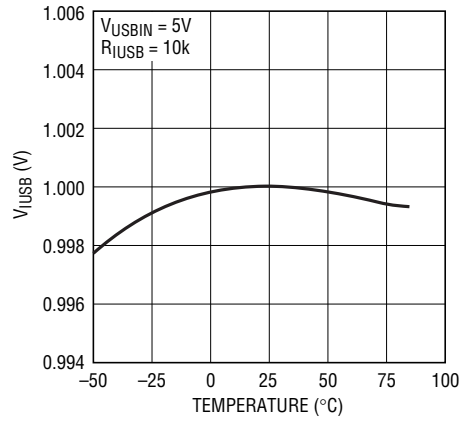

## TYPICAL PERFORMANCE CHARACTERISTICS $T_A = 25^\circ\text{C}$ , unless otherwise noted.

**IDC Pin Voltage vs  $V_{\text{DCIN}}$   
(Constant-Current Mode)**

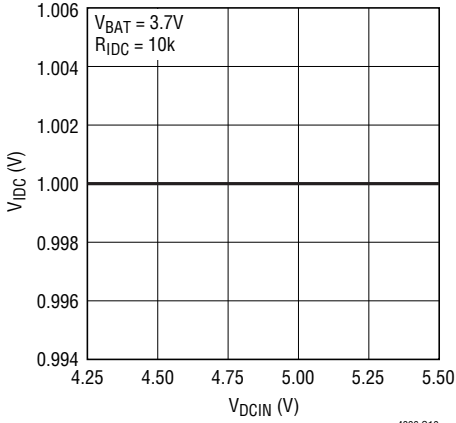

4096 G10

**IUSB Pin Voltage vs  $V_{\text{USBIN}}$   
(Constant-Current Mode)**

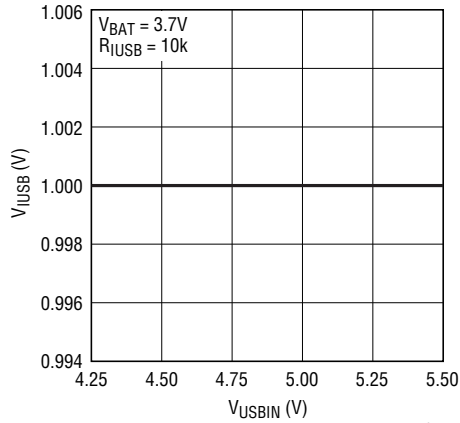

4096 G11

**Recharge Threshold Voltage  
vs Temperature**

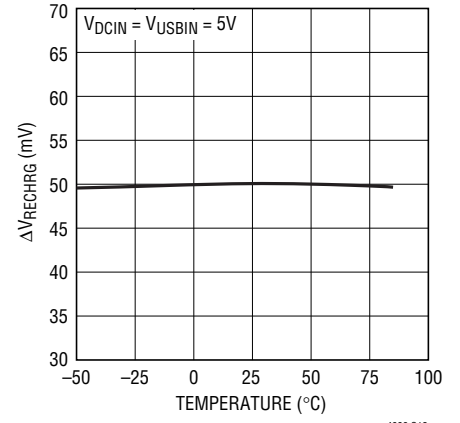

4096 G12

**Charge Current vs Battery Voltage**

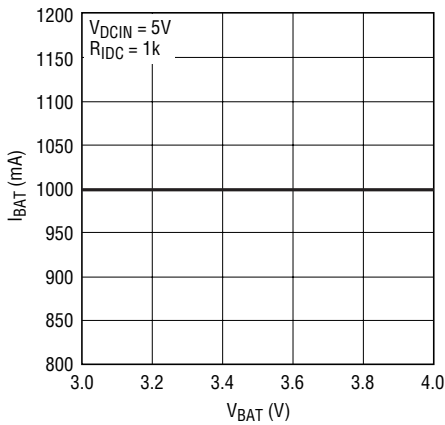

4096 G13

**Charge Current vs Battery Voltage**

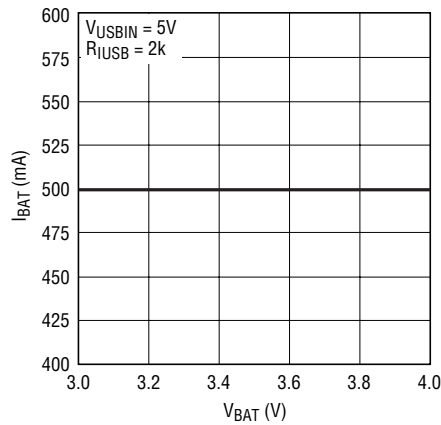

4096 G14

**Charge Current vs Ambient  
Temperature with Thermal  
Regulation**

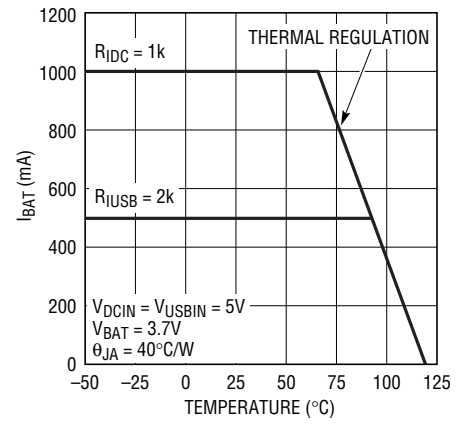

4096 G15

**Charge Current vs Supply Voltage**

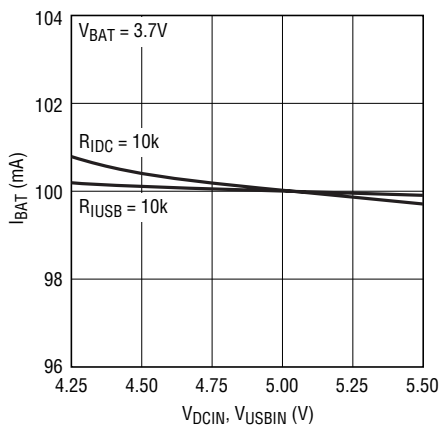

4096 G16

**Charge Current vs Battery Voltage**

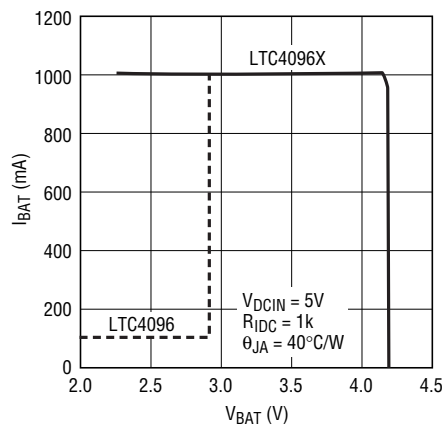

4096 G17

**Charge Current vs Battery Voltage**

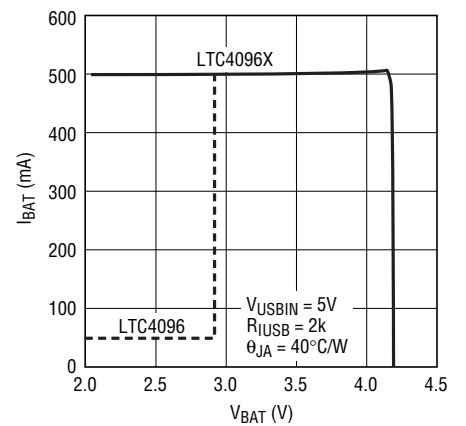

4096 G18

## TYPICAL PERFORMANCE CHARACTERISTICS $T_A = 25^\circ\text{C}$ , unless otherwise noted.

**DCIN Power FET On-Resistance vs Temperature**

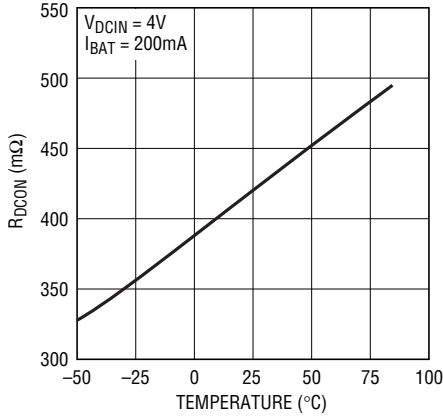

4096 G19

**USBIN Power FET On-Resistance vs Temperature**

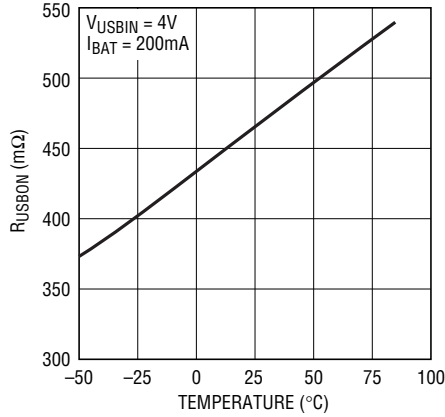

4096 G20

**PWR-DCIN and PWR-USBIN Power FET On-Resistance vs Temperature**

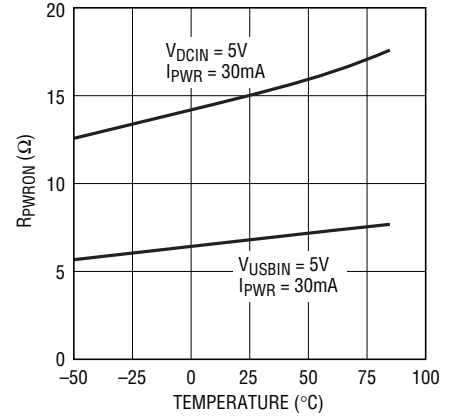

4096 G21

**V\_PWR vs I\_PWR**

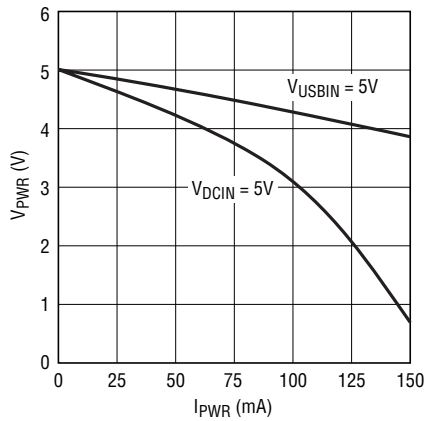

4096 G22

**CHRG Pin I-V Curve**

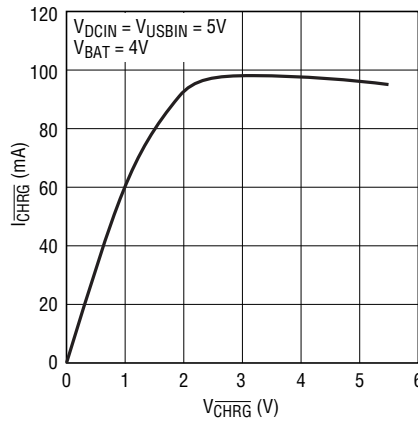

4096 G23

**CHRG Pin Output Low Voltage vs Temperature**

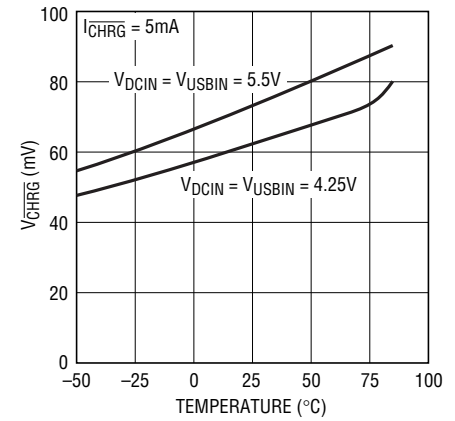

4096 G24

**SUSP Pin Threshold Voltage (On-to-Off) vs Temperature**

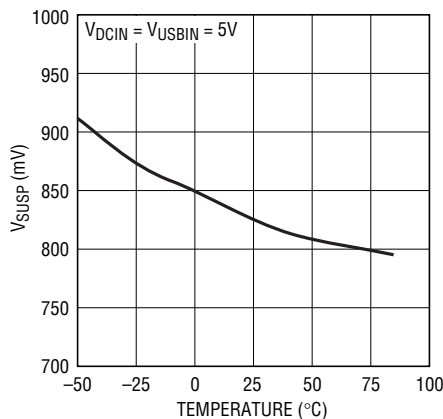

4096 G25

**SUSP Pin Pulldown Resistance vs Temperature**

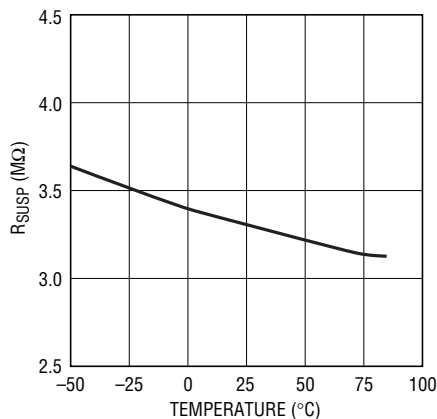

4096 G26

**Shutdown Supply Current vs Temperature and V\_DCIN**

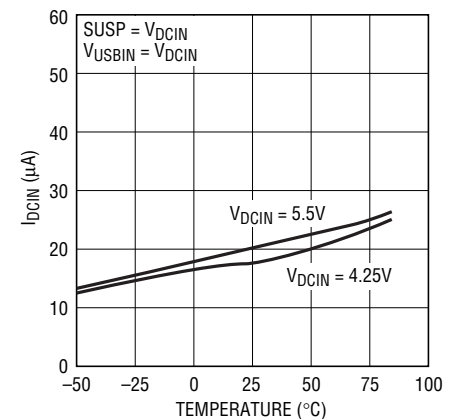

4096 G27

## TYPICAL PERFORMANCE CHARACTERISTICS $T_A = 25^\circ\text{C}$ , unless otherwise noted.

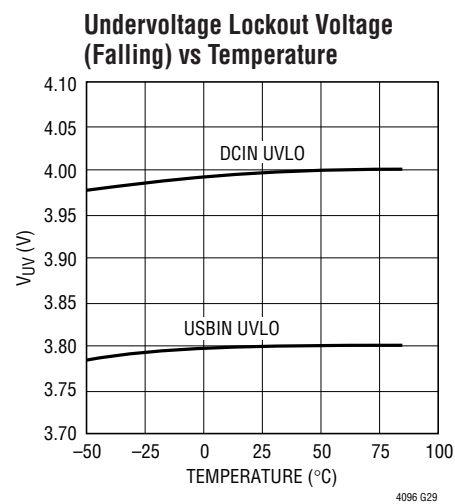
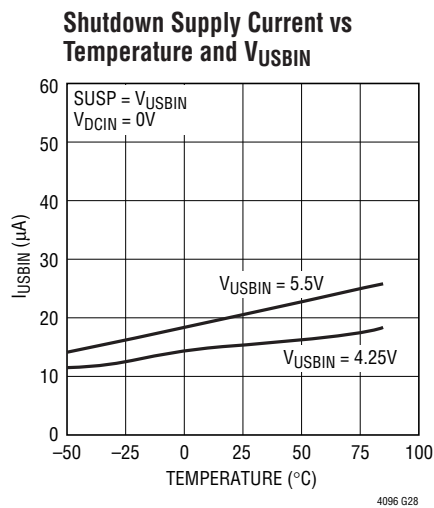

## PIN FUNCTIONS

**DCIN (Pin 1):** Wall Adapter Input Supply Pin. Provides power to the battery charger. The maximum supply current is 1.2A. This pin should be bypassed with a  $1\mu\text{F}$  capacitor.

**USBIN (Pin 2):** USB Input Supply Pin. Provides power to the battery charger. The maximum supply current is 1A. This pin should be bypassed with a  $1\mu\text{F}$  capacitor.

**PWR (Pin 3):** Power Present Output. When the DCIN or USBIN pin voltage is sufficient to begin charging (i.e. when the DCIN or USBIN supply is greater than the undervoltage lockout thresholds and at least 100mV or 150mV, respectively, above the battery terminal), the PWR pin is connected to the appropriate input through an internal P-channel MOSFET. If sufficient voltage to charge is not present on DCIN or USBIN the PWR pin is high impedance. This output is able to source up to 120mA.

**CHRG (Pin 4):** Open-Drain Charge Status Output. When the LTC4096 is charging, the CHRG pin is pulled low by an internal N-channel MOSFET. When the charge cycle is completed, CHRG becomes high impedance. This output is capable of sinking up to 10mA, making it suitable for driving an LED.

**SUSP (Pin 5):** Charge Enable Input. A logic low on this pin enables the charger. If left floating, an internal  $3.4\text{M}\Omega$  pull-down resistor defaults the LTC4096 to charge mode. Pull this pin high for shutdown.

**ITERM (Pin 6):** Charge Termination Current Threshold Program. The termination current threshold,  $I_{\text{TERMINATE}}$ , is set by connecting a resistor,  $R_{\text{ITERM}}$ , to ground.  $I_{\text{TERMINATE}}$  is set by the following formula:

$$I_{\text{TERMINATE}} = \frac{100\text{V}}{R_{\text{ITERM}}}$$

When the battery current,  $I_{\text{BAT}}$ , falls below the termination threshold, charging stops and the CHRG output becomes high impedance.

**IUSB (Pin 7):** Charge Current Program for USB Power. The charge current is set by connecting a resistor,  $R_{\text{IUSB}}$ , to ground. When charging in constant-current mode, this pin serves to 1V. The voltage on this pin can be used to measure the battery current delivered from the USBIN input using the following formula:

$$I_{\text{BAT}} = \frac{V_{\text{IUSB}}}{R_{\text{IUSB}}} \cdot 1000$$



## PIN FUNCTIONS

**GND (Pin 8):** Ground.

**IDC (Pin 9):** Charge Current Program for Wall Adapter Power. The charge current is set by connecting a resistor,  $R_{IDC}$ , to ground. When charging in constant-current mode, this pin serves to 1V. The voltage on this pin can be used to measure the battery current delivered from the DCIN input using the following formula:

$$I_{BAT} = \frac{V_{IDC}}{R_{IDC}} \cdot 1000$$

**BAT (Pin 10):** Charger Output. This pin provides charge current to the battery and regulates the final float voltage to 4.2V.

**Exposed Pad (Pin 11):** GND. The exposed backside of the package is ground and must be soldered to PC board ground for electrical connection and maximum heat transfer.

## BLOCK DIAGRAM

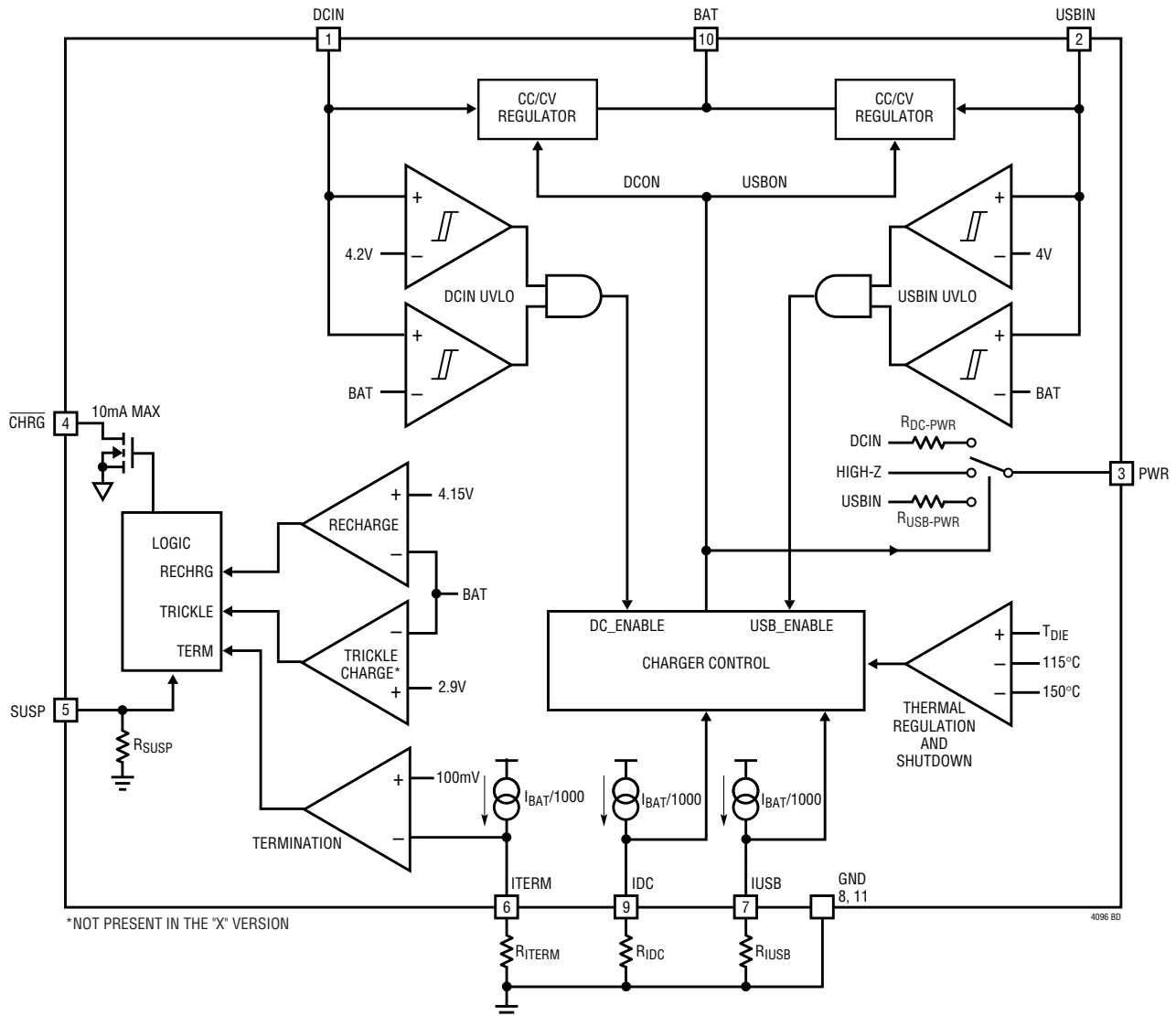

## OPERATION

The LTC4096 is designed to efficiently manage charging a single-cell lithium-ion battery from two separate voltage sources: a wall adapter and USB power bus. Using the constant-current/constant-voltage algorithm, the charger can deliver up to 1.2A of charge current from the wall adapter supply or up to 1A of charge current from the USB supply with a final float voltage accuracy of  $\pm 0.6\%$ . The LTC4096 has two internal P-channel power MOSFETs, thermal regulation and shut down circuitry. No blocking diodes or external sense resistors are required.

### Power Source Selection

The LTC4096 can charge a battery from either the wall adapter input or the USB port input. The LTC4096 automatically senses the presence of voltage at each input. If both voltage sources are present, the LTC4096 defaults to the wall adapter source provided sufficient voltage is present at the DCIN input. “Sufficient voltage” is defined as:

- Supply voltage is greater than the UVLO threshold.
- Supply voltage is greater than the battery voltage by 30mV (100mV or 150mV rising, 30mV falling).

The power present output pin (PWR) indicates that sufficient input voltage is available. Table 1 describes the behavior of this status output.

### Programming and Monitoring Charge Current

The charge current delivered to the battery from the wall adapter supply is programmed using a single resistor from the IDC pin to ground.

$$R_{IDC} = \frac{1000V}{I_{CHRG(DC)}}, I_{CHRG(DC)} = \frac{1000V}{R_{IDC}}$$

Similarly, the charge current from the USB supply is programmed using a single resistor from the IUSB pin to ground.

$$R_{IUSB} = \frac{1000V}{I_{CHRG(USB)}}, I_{CHRG(USB)} = \frac{1000V}{R_{IUSB}}$$

Charge current out of the BAT pin can be determined at any time by monitoring the IDC or IUSB pin voltage and applying the following equations:

$$I_{BAT} = \frac{V_{IDC}}{R_{IDC}} \cdot 1000, \text{ (charging from wall adapter)}$$

$$I_{BAT} = \frac{V_{IUSB}}{R_{IUSB}} \cdot 1000, \text{ (charging from USB supply)}$$

**Table 1. Power Source Selection**

	<b>V<sub>USBIN</sub> &gt; 4V and V<sub>USBIN</sub> &gt; BAT + 30mV</b>	<b>V<sub>USBIN</sub> &lt; 4V or V<sub>USBIN</sub> &lt; BAT + 30mV</b>
<b>V<sub>DCIN</sub> &gt; 4.2V and V<sub>DCIN</sub> &gt; BAT + 30mV</b>	Charger powered from wall adapter source; $V_{PWR} = V_{DCIN} - R_{DC-PWR} \cdot I_{PWR}$ USBIN current < 25 $\mu$ A	Charger powered from wall adapter source $V_{PWR} = V_{DCIN} - R_{DC-PWR} \cdot I_{PWR}$
<b>V<sub>DCIN</sub> &lt; 4.2V or V<sub>DCIN</sub> &lt; BAT + 30mV</b>	Charger powered from USB source; $V_{PWR} = V_{USBIN} - R_{USB-PWR} \cdot I_{PWR}$	No charging PWR: Hi-Z

## OPERATION

### Programming Charge Termination

The charge cycle terminates when the charge current falls below the programmed termination threshold during constant-voltage mode. This threshold is set by connecting an external resistor,  $R_{\text{ITERM}}$ , from the ITERM pin to ground.

The charge termination current threshold ( $I_{\text{TERMINATE}}$ ) is set by the following equation:

$$R_{\text{ITERM}} = \frac{100\text{V}}{I_{\text{TERMINATE}}}, I_{\text{TERMINATE}} = \frac{100\text{V}}{R_{\text{ITERM}}}$$

The termination condition is detected by using an internal filtered comparator to monitor the ITERM pin. When the ITERM pin voltage drops below 100mV\* for longer than  $t_{\text{TERMINATE}}$  (typically 3ms), the charge cycle terminates, charge current latches off and the LTC4096 enters standby mode. When charging, transient loads on the BAT pin can cause the ITERM pin to fall below 100mV for short periods of time before the DC charge current has dropped below the programmed termination current. The 3ms filter time ( $t_{\text{TERMINATE}}$ ) on the termination comparator ensures that transient loads of this nature do not result in premature charge cycle termination. Once the average charge current drops below the programmed termination threshold, the LTC4096 terminates the charge cycle and stops providing any current out of the BAT pin. In this state, any load on the BAT pin must be supplied by the battery.

### Low-Battery Charge Conditioning (Trickle Charge)

This feature ensures that deeply discharged batteries are gradually charged before applying full charge current. If the BAT pin voltage is below 2.9V, the LTC4096 supplies 1/10th of the full charge current to the battery until the BAT pin rises above 2.9V. For example, if the charger is programmed to charge at 800mA from the wall adapter input and 500mA from the USB input, the charge current

during trickle charge mode would be 80mA and 50mA, respectively.

The LTC4096X has no trickle charge mode.

### Automatic Recharge

In standby mode, the charger sits idle and monitors the battery voltage using a comparator with a 1.6ms filter time ( $t_{\text{RECHRG}}$ ). A charge cycle automatically restarts when the battery voltage falls below 4.15V (which corresponds to approximately 80%-90% battery capacity). This ensures that the battery is kept at, or near, a fully charged condition and eliminates the need for periodic charge cycle initiations. If the battery is removed from the charger, a sawtooth waveform appears at the battery output. This is caused by the repeated cycling between termination and recharge events. This cycling results in pulsing at the  $\overline{\text{CHRG}}$  output; an LED connected to this pin will exhibit a blinking pattern, indicating to the user that a battery is not present. The frequency of the sawtooth is dependent on the amount of output capacitance.

### Status Indicators

The charge status output ( $\overline{\text{CHRG}}$ ) has two states: pull-down and high impedance. The pull-down state indicates that the LTC4096 is in a charge cycle. Once the charge cycle has terminated or the LTC4096 is disabled, the pin state becomes high impedance. The pull-down state is capable of sinking up to 10mA.

The power present output (PWR) has two states: DCIN/USBIN voltages and high impedance. These states are described in Table 1 and the circuit is shown in Figure 2. The high impedance state indicates that voltage is not present at either DCIN or USBIN, so LTC4096 lacks sufficient power to charge the battery. The PWR present output is capable of sourcing up to 120mA steady state and includes short circuit protection.

\*Any external sources that hold the ITERM pin above 100mV will prevent the LTC4096 from terminating a charge cycle.

## APPLICATIONS INFORMATION

### Manual Shutdown

The SUSP pin has a 3.4MΩ pulldown resistor to GND. A logic low enables the charger and logic high disables it (the pulldown defaults the charger to the charging state). The DCIN input draws 20μA when the charger is in shutdown. The USBIN input draws 20μA during shutdown if no power is applied to DCIN, but draws only 10μA when  $V_{DCIN} > V_{USBIN}$ .

### Thermal Limiting

An internal thermal feedback loop reduces the programmed charge current if the die temperature attempts to rise

above a preset value of approximately 115°C. This feature protects the LTC4096 from excessive temperature and allows the user to push the limits of the power handling capability of a given circuit board without risk of damaging the device. The charge current can be set according to typical (not worst case) ambient temperature with the assurance that the charger will automatically reduce the current in worst case conditions. A safety thermal shutdown circuit will turn off the charger if the die temperature rises above a value of approximately 150°C. DFN power considerations are discussed further in the Applications Information section.

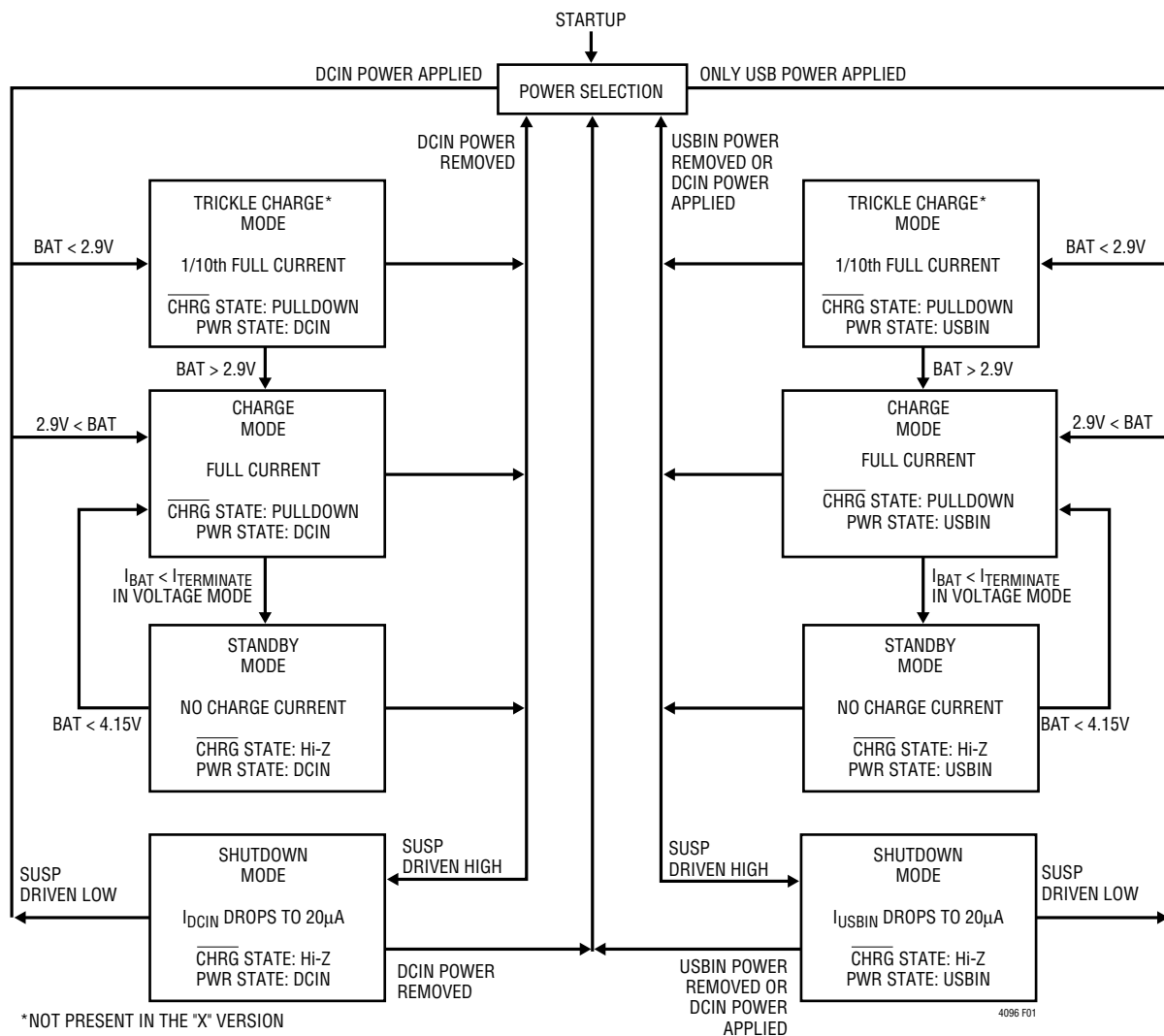

Figure 1. LTC4096 State Diagram of a Charge Cycle

## APPLICATIONS INFORMATION

### Using a Single Charge Current Program Resistor

In applications where the programmed wall adapter charge current and USB charge current are the same, a single program resistor can be used to set both charge currents. Figure 3 shows a charger circuit that uses one charge current program resistor. In this circuit, one resistor programs the same charge current for each input supply.

$$I_{\text{CHRG(DC)}} = I_{\text{CHRG(USB)}} = \frac{1000\text{V}}{R_{\text{ISET}}}$$

The LTC4096 can also program the wall adapter charge current and USB charge current independently using two program resistors,  $R_{\text{IDC}}$  and  $R_{\text{IUSB}}$ . Figure 4 shows a charger circuit that sets the wall adapter charge current to 800mA and the USB charge current to 500mA.

### Stability Considerations

The constant-voltage mode feedback loop is stable without any compensation provided a battery is connected to the charger output. However, a  $4.7\mu\text{F}$  capacitor with a  $1\Omega$  series resistor is recommended at the BAT pin to keep the ripple voltage low when the battery is disconnected. When the charger is in constant-current mode, the charge current program pin (IDC or IUSB) is in the feedback loop, not the battery. The constant-current mode stability is affected by the impedance at the charge current program pin. With no additional capacitance on this pin, the charger is stable with program resistor values as high as  $20\text{K}\Omega$  ( $I_{\text{CHRG}} = 50\text{mA}$ ); however, additional capacitance on these nodes reduces the maximum allowed program resistor.

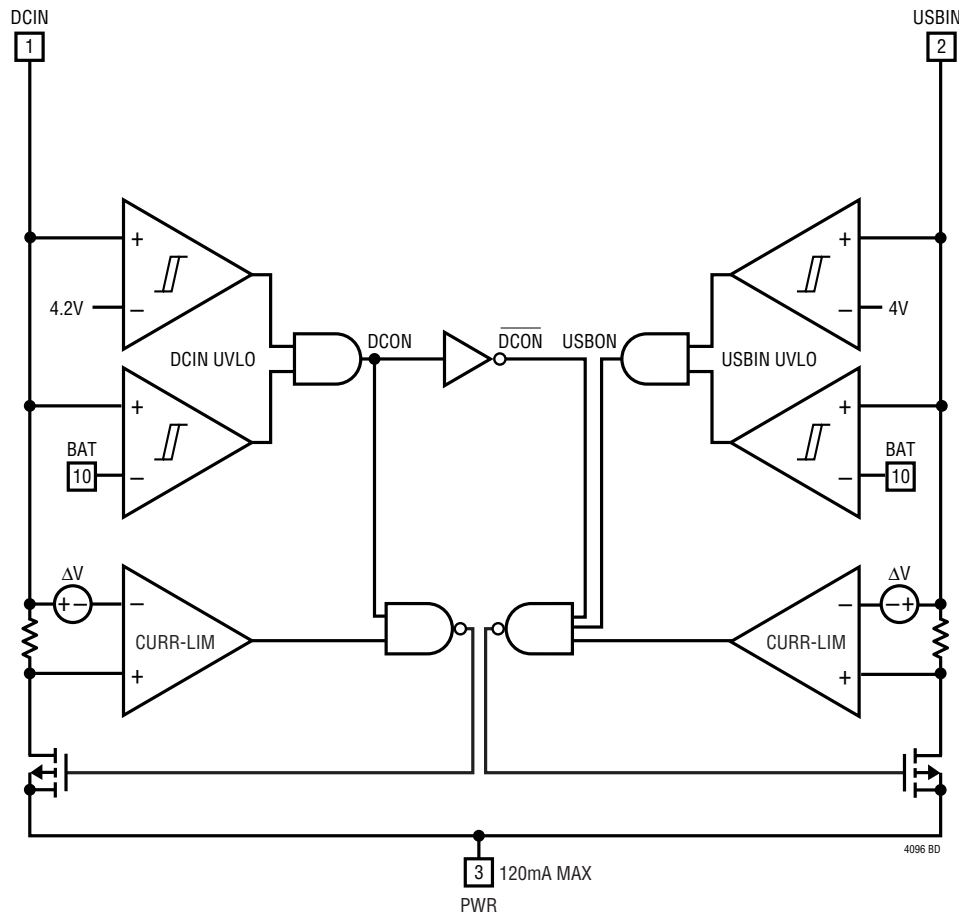
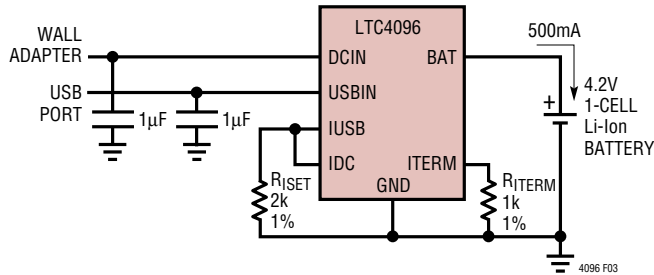

Figure 2. Input Power Present Output (PWR) Circuit



## APPLICATIONS INFORMATION



**Figure 3. Dual Input Charger Circuit. The Wall Adapter Charge Current and USB Charge Current are Both Programmed to be 500mA**

## Power Dissipation

When designing the battery charger circuit, it is not necessary to design for worst-case power dissipation scenarios because the LTC4096 automatically reduces the charge current during high power conditions. The conditions that cause the LTC4096 to reduce charge current through thermal feedback can be approximated by considering the power dissipated in the IC. Most of the power dissipation is generated from the internal MOSFET pass device. Thus, the power dissipation is calculated to be:

$$P_D = (V_{IN} - V_{BAT}) \cdot I_{BAT}$$

$P_D$  is the power dissipated,  $V_{IN}$  is the input supply voltage (either DCIN or USBIN),  $V_{BAT}$  is the battery voltage and  $I_{BAT}$  is the charge current. The approximate ambient temperature at which the thermal feedback begins to protect the IC is:

$$T_A = 115^\circ\text{C} - P_D \cdot \theta_{JA}$$

$$T_A = 115^\circ\text{C} - (V_{IN} - V_{BAT}) \cdot I_{BAT} \cdot \theta_{JA}$$

Example: An LTC4096 operating from a 5V wall adapter (on the DCIN input) is programmed to supply 800mA full-scale current to a discharged Li-Ion battery with a voltage of 3.3V. Assuming  $\theta_{JA}$  is  $40^\circ\text{C}/\text{W}$  (see Thermal Considerations), the ambient temperature at which the LTC4096 will begin to reduce the charge current is approximately:

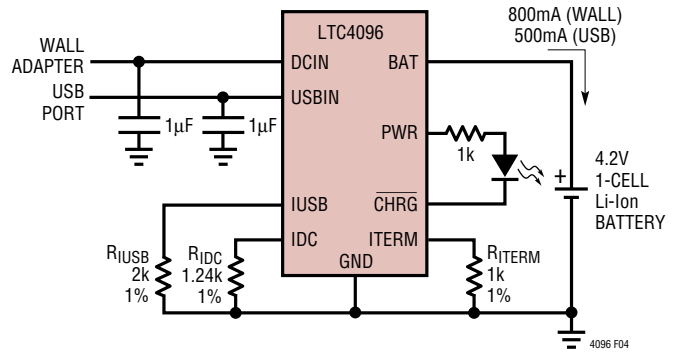

**Figure 4. Full Featured Dual Input Charger Circuit**

$$T_A = 115^\circ\text{C} - (5\text{V} - 3.3\text{V}) \cdot (800\text{mA}) \cdot 40^\circ\text{C}/\text{W}$$

$$T_A = 115^\circ\text{C} - 1.36\text{W} \cdot 40^\circ\text{C}/\text{W} = 115^\circ\text{C} - 54.4^\circ\text{C}$$

$$T_A = 60.6^\circ\text{C}$$

The LTC4096 can be used above  $60.6^\circ\text{C}$  ambient, but the charge current will be reduced from 800mA. The approximate current at a given ambient temperature can be approximated by:

$$I_{BAT} = \frac{105^\circ\text{C} - T_A}{(V_{IN} - V_{BAT}) \cdot \theta_{JA}}$$

Using the previous example with an ambient temperature of  $70^\circ\text{C}$ , the charge current will be reduced to approximately:

$$I_{BAT} = \frac{105^\circ\text{C} - 60^\circ\text{C}}{(5\text{V} - 3.3\text{V}) \cdot 40^\circ\text{C}/\text{W}} = \frac{45^\circ\text{C}}{68^\circ\text{C}/\text{A}}$$

$$I_{BAT} = 662\text{mA}$$

It is important to remember that LTC4096 applications do not need to be designed for worst-case thermal conditions, since the IC will automatically reduce power dissipation when the junction temperature reaches approximately  $115^\circ\text{C}$ . Moreover a thermal shut down protection circuit around  $150^\circ\text{C}$  safely prevents any damage putting LTC4096 into shut down mode.

## APPLICATIONS INFORMATION

### Thermal Considerations

In order to deliver maximum charge current under all conditions, it is critical that the exposed metal pad on the backside of the LTC4096 package is properly soldered to the PC board ground. When correctly soldered to a 2500mm<sup>2</sup> double sided 1oz copper board, the LTC4096 has a thermal resistance of approximately 40°C/W. Failure to make thermal contact between the exposed pad on the backside of the package and the copper board will result in thermal resistances far greater than 40°C/W. As an example, a correctly soldered LTC4096 can deliver over 800mA to a battery from a 5V supply at room temperature. Without a good backside thermal connection, this number would drop to much less than 500mA.

### Protecting the USB Pin and Wall Adapter Input from Overvoltage Transients

Caution must be exercised when using ceramic capacitors to bypass the USBIN pin or the wall adapter inputs. High voltage transients can be generated when the USB or wall

adapter is hot plugged. When power is supplied via the USB bus or wall adapter, the cable inductance along with the self resonant and high Q characteristics of ceramic capacitors can cause substantial ringing which could exceed the maximum voltage ratings and damage the LTC4096. Refer to Linear Technology Application Note 88, entitled “Ceramic Input Capacitors Can Cause Overvoltage Transients” for a detailed discussion of this problem.

**Always use an oscilloscope to check the voltage waveforms at the USBIN and DCIN pins during USB and wall adapter hot-plug events to ensure that overvoltage transients have been adequately removed.**

### Reverse Polarity Input Voltage Protection

In some applications, protection from reverse polarity voltage on the input supply pins is desired. If the supply voltage is high enough, a series blocking diode can be used. In other cases where the voltage drop must be kept low, a P-channel MOSFET can be used (as shown in Figure 5).

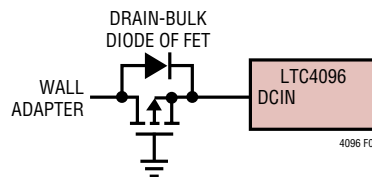
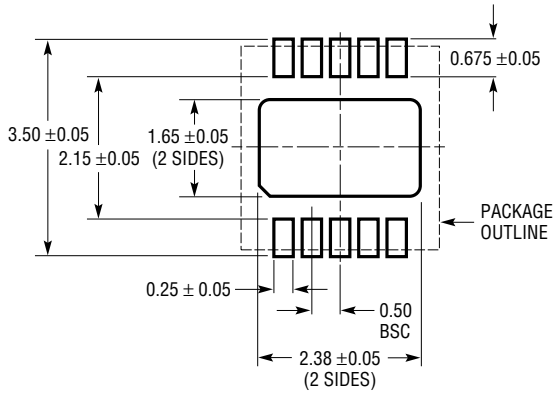

Figure 5. Low Loss Input Reverse Polarity Protection

# PACKAGE DESCRIPTION

**DD Package**  
**10-Lead Plastic DFN (3mm × 3mm)**  
 (Reference LTC DWG # 05-08-1698)



**RECOMMENDED SOLDER PAD PITCH AND DIMENSIONS**

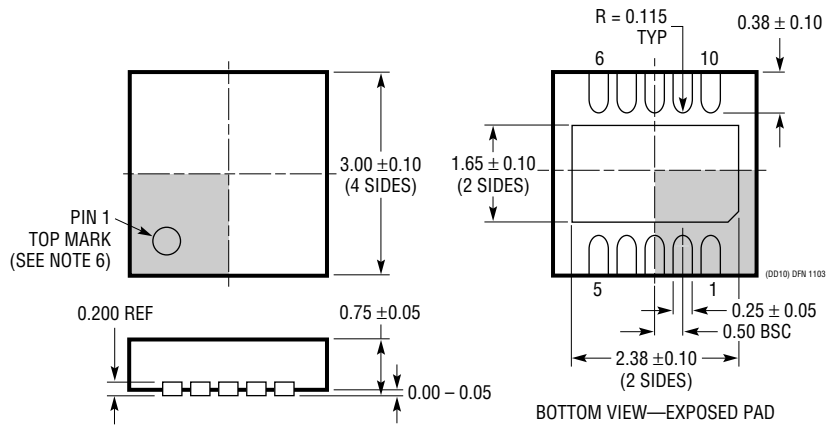

- NOTE:
1. DRAWING TO BE MADE A JEDEC PACKAGE OUTLINE M0-229 VARIATION OF (WEED-2). CHECK THE LTC WEBSITE DATA SHEET FOR CURRENT STATUS OF VARIATION ASSIGNMENT
  2. DRAWING NOT TO SCALE
  3. ALL DIMENSIONS ARE IN MILLIMETERS
  4. DIMENSIONS OF EXPOSED PAD ON BOTTOM OF PACKAGE DO NOT INCLUDE MOLD FLASH. MOLD FLASH, IF PRESENT, SHALL NOT EXCEED 0.15mm ON ANY SIDE
  5. EXPOSED PAD SHALL BE SOLDER PLATED
  6. SHADED AREA IS ONLY A REFERENCE FOR PIN 1 LOCATION ON THE TOP AND BOTTOM OF PACKAGE

# LTC4096/LTC4096X

## RELATED PARTS

PART NUMBER	DESCRIPTION	COMMENTS
LTC3455	Dual DC/DC Converter with USB Power Management and Li-Ion Battery Charger	Efficiency >96%, Accurate USB Current Limiting (500mA/100mA), 4mm × 4mm QFN-24 Package
LTC4053	USB Compatible Monolithic Li-Ion Battery Charger	Standalone Charger with Programmable Timer, Up to 1.25A Charge Current
LTC4054/LTC4054X	Standalone Linear Li-Ion Battery Charger with Integrated Pass Transistor in ThinSOT™	Thermal Regulation Prevents Overheating, C/10 Termination, C/10 Indicator, Up to 800mA Charge Current
LTC4055	USB Power Controller and Battery Charger	Charges Single-Cell Li-Ion Batteries Directly from USB Port, Thermal Regulation, 4mm × 4mm QFN-16 Package
LTC4058/LTC4058X	Standalone 950mA Lithium-Ion Charger in DFN	C/10 Charge Termination, Battery Kelvin Sensing, ±7% Charge Accuracy
LTC4061	Standalone Li-Ion Charger with Thermistor Interface	4.2V, ±0.35% Float Voltage, Up to 1A Charge Current, 3mm × 3mm DFN-10 Package
LTC4061-4.4	Standalone Li-Ion Charger with Thermistor Interface	4.4V, ±0.4% Float Voltage, Up to 1A Charge Current, 3mm × 3mm DFN-10 Package
LTC4062	Standalone Li-Ion Charger with Micropower Comparator	4.2V, ±0.35% Float Voltage, Up to 1A Charge Current, 3mm × 3mm DFN-10 Package
LTC4065/LTC4065A	Standalone 750mA Li-Ion Charger in 2mm × 2mm DFN	4.2V, ±0.6% Float Voltage, Up to 750mA Charge Current, 2mm × 2mm DFN-6 Package
LTC4066	USB Power Controller and Li-Ion Linear Battery Charger with Low-Loss Ideal Diode	Seamless Transition Between Input Power Sources: Li-Ion Battery, USB and Wall Adapter, Low-Loss (50mΩ) Ideal Diode, 4mm × 4mm QFN-24 Package
LTC4068/LTC4068X	Standalone Linear Li-Ion Battery Charger with Programmable Termination	Charge Current up to 950mA, Thermal Regulation, 3mm × 3mm DFN-8 Package
LTC4069	Standalone Li-Ion Battery Charger with NTC Thermistor Input in 2mm × 2mm DFN	4.2V, ±0.6% Float Voltage, Up to 750mA Charge Current, Timer Termination + C/10 Detection Output
LTC4075	Dual Input Standalone Li-Ion Battery Charger	Charges Single-Cell Li-Ion Batteries from Wall Adapter and USB Inputs with Automatic Input Power Detection and Selection, 950mA Charger Current, Thermal Regulation, C/X Charge Termination, 3mm × 3mm DFN Package
LTC4076	Dual Input Standalone Li-Ion Battery Charger	Charges Single-Cell Li-Ion Batteries from Wall Adapter and USB Inputs with Automatic Input Power Detection and Selection, 950mA Charger Current, Thermal Regulation, C/X Charge Termination, 3mm × 3mm DFN Package
LTC4077	Dual Input Standalone Li-Ion Battery Charger	Charges Single-Cell Li-Ion Batteries from Wall Adapter and USB Inputs with Automatic Input Power Detection and Selection, 950mA Charger Current, Thermal Regulation, C/10 Charge Termination, 3mm × 3mm DFN Package
LTC4085	USB Power Manager with Ideal Diode Controller and Li-Ion Charger	Charges Single-Cell Li-Ion Batteries Directly from a USB Port, Thermal Regulation, 200mΩ Ideal Diode with <50mΩ option, 4mm × 3mm DFN-14 Package
LTC4089/ LTC4089-5	USB Power Manager with Ideal Diode Controller and High Efficiency Li-Ion Battery Charger	High Efficiency 1.2A Charger from 6V to 36V (40V Max) Input, Charges Single Cell Li-Ion Batteries Directly from a USB Port, Thermal Regulation; 200mΩ Ideal Diode with <50mΩ Option, 4mm × 3mm DFN-14 Package, Bat-Track Adaptive Output Control (LTC4089); Fixed 5V Output (LTC4089-5)
LTC4410	USB Power Manager and Battery Charger	Manages Total Power Between a USB Peripheral and Battery Charger, Ultralow Battery Drain: 1μA, ThinSOT Package
LTC4411/LTC4412	Low Loss PowerPath™ Controller in ThinSOT	Automatic Switching Between DC Sources, Load Sharing, Replaces ORing Diodes

ThinSOT and PowerPath are trademarks of Linear Technology Corporation

4096xf