



Chipsmall Limited consists of a professional team with an average of over 10 year of expertise in the distribution of electronic components. Based in Hongkong, we have already established firm and mutual-benefit business relationships with customers from,Europe,America and south Asia,supplying obsolete and hard-to-find components to meet their specific needs.

With the principle of “Quality Parts,Customers Priority,Honest Operation,and Considerate Service”,our business mainly focus on the distribution of electronic components. Line cards we deal with include Microchip,ALPS,ROHM,Xilinx,Pulse,ON,Everlight and Freescale. Main products comprise IC,Modules,Potentiometer,IC Socket,Relay,Connector.Our parts cover such applications as commercial,industrial, and automotives areas.

We are looking forward to setting up business relationship with you and hope to provide you with the best service and solution. Let us make a better world for our industry!



## Contact us

Tel: +86-755-8981 8866 Fax: +86-755-8427 6832

Email & Skype: info@chipsmall.com Web: www.chipsmall.com

Address: A1208, Overseas Decoration Building, #122 Zhenhua RD., Futian, Shenzhen, China



### FEATURES

- Allows Safe Insertion into Live AMC or MicroTCA Backplane
- Controls 12V Main and 3.3V Auxiliary Supplies
- Limits Peak Fault Current in  $\leq 1\mu\text{s}$
- Adjustable Current Limit with Circuit Breaker
- Integrated  $0.3\Omega$  AUX Switch
- High Side Current Sense
- Gate Drive for External N-Channel MOSFET
- Adjustable Response Time for Overcurrent Protection
- Adjustable Supply Voltage Power-Up Rate
- Thermal Shutdown Protection
- LTC4223-1: Latch Off After Fault
- LTC4223-2: Automatic Retry After Fault
- 16-Lead SSOP and  $5\text{mm} \times 4\text{mm}$  DFN Packages

### APPLICATIONS

- Advanced Mezzanine Card, MicroTCA Systems
- Workstations and Server I/O
- Telecom Networks

### DESCRIPTION

The LTC<sup>®</sup>4223 positive voltage Hot Swap<sup>™</sup> controller allows a board to be safely inserted and removed from a live AMC or MicroTCA backplane. It controls the main 12V supply with an external N-channel MOSFET and the 3.3V auxiliary supply with an integrated switch. The 12V output ramp rate is adjustable and includes inrush current limiting. The 12V output is also protected against short circuit faults with a fast acting current limit and a 5% accurate timed circuit breaker. The 3.3V output includes both soft start and overcurrent protection.

The LTC4223 features a current monitor output for the 12V supply, and reports fault and power-good status for both supplies. It also detects card presence and allows independent control of the 12V and auxiliary 3.3V supply outputs. The LTC4223-1 features a latch-off circuit breaker, while the LTC4223-2 provides automatic retry after a fault.

*LT*, *LT*, *LTC* and *LTM* are registered trademarks of Linear Technology Corporation. All other trademarks are the property of their respective owners.

### TYPICAL APPLICATION

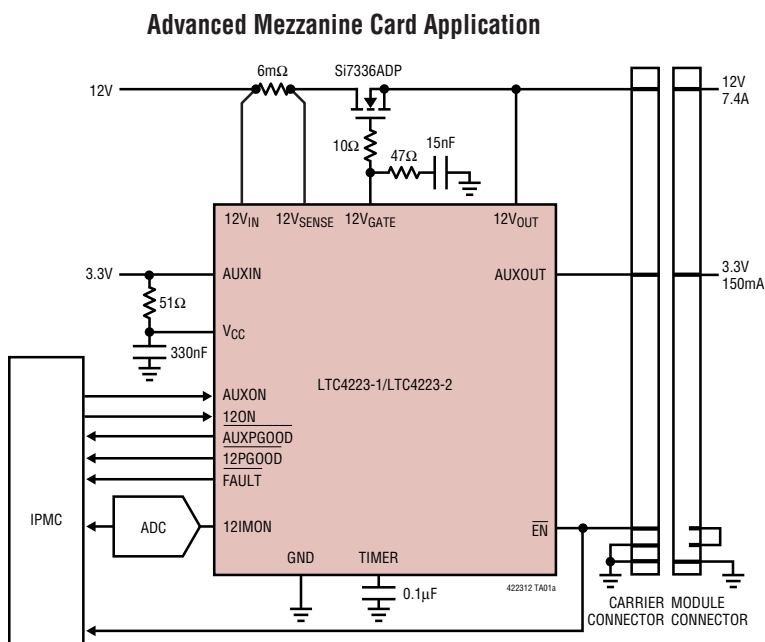

### Normal Power-Up Waveform

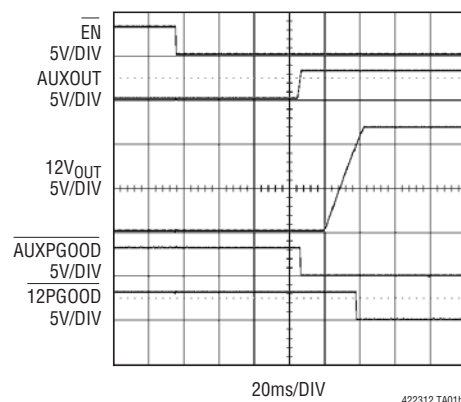

# LTC4223-1/LTC4223-2

## ABSOLUTE MAXIMUM RATINGS

(Note 1)

### Supply Voltages

12V <sub>IN</sub> .....	-0.3V to 20V
AUXIN .....	-0.3V to 10V
V <sub>CC</sub> .....	-0.3V to 7V

### Input Voltages

12ON, AUXON, $\overline{\text{EN}}$ .....	-0.3V to 7V
TIMER .....	-0.3V to V <sub>CC</sub> + 0.3V
12V <sub>SENSE</sub> .....	-0.3V to 20V

### Output Voltages

FAULT, 12PGOOD, AUXPGOOD, 12IMON .....	-0.3V to 7V
---	-------------

12V <sub>GATE</sub> .....	-0.3V to 25V
12V <sub>OUT</sub> - 12V <sub>GATE</sub> (Note 3) .....	-4.5V to 0.3V
AUXOUT .....	-0.3V to 10V

### Operating Temperature Range

LTC4223-1C/ LTC4223-2C .....	0°C to 70°C
LTC4223-1I/ LTC4223-2I .....	-40°C to 85°C

### Storage Temperature Range

GN Package .....	-65°C to 150°C
DHD Package .....	-65°C to 125°C

### Lead Temperature (Soldering, 10sec)

GN Package .....	300°C
------------------	-------

## PIN CONFIGURATION

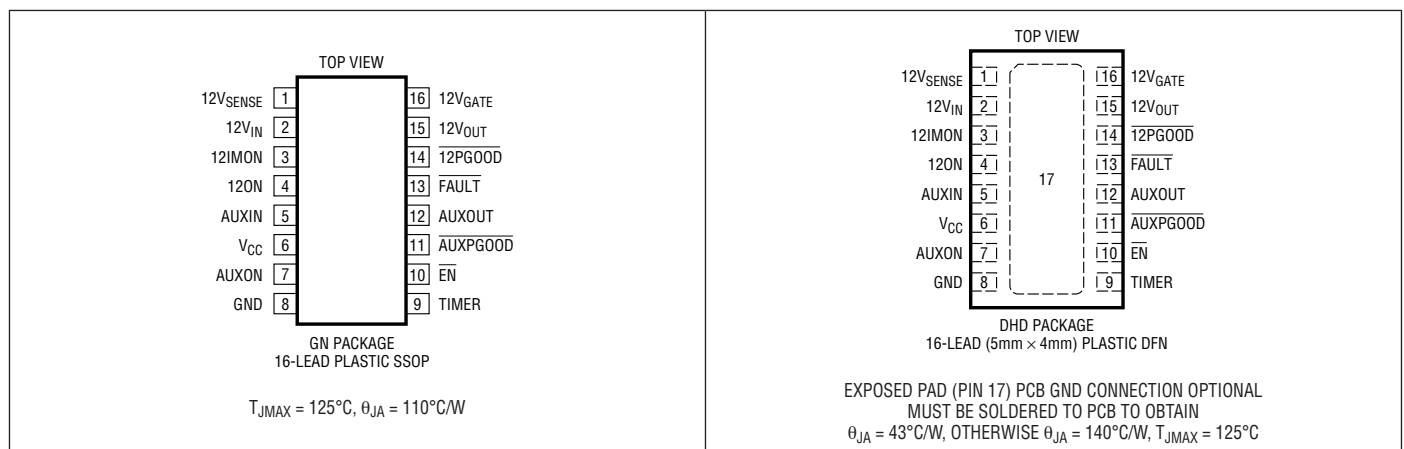

## ORDER INFORMATION

LEAD FREE FINISH	TAPE AND REEL	PART MARKING*	PACKAGE DESCRIPTION	TEMPERATURE RANGE
LTC4223CDHD-1#PBF	LTC4223CDHD-1#TRPBF	42231	16-Lead (5mm × 4mm) Plastic DFN	0°C to 70°C
LTC4223CDHD-2#PBF	LTC4223CDHD-2#TRPBF	42232	16-Lead (5mm × 4mm) Plastic DFN	0°C to 70°C
LTC4223IDHD-1#PBF	LTC4223IDHD-1#TRPBF	42231	16-Lead (5mm × 4mm) Plastic DFN	-40°C to 85°C
LTC4223IDHD-2#PBF	LTC4223IDHD-2#TRPBF	42232	16-Lead (5mm × 4mm) Plastic DFN	-40°C to 85°C
LTC4223CGN-1#PBF	LTC4223CGN-1#TRPBF	42231	16-Lead Plastic SSOP	0°C to 70°C
LTC4223CGN-2#PBF	LTC4223CGN-2#TRPBF	42232	16-Lead Plastic SSOP	0°C to 70°C
LTC4223IGN-1#PBF	LTC4223IGN-1#TRPBF	422311	16-Lead Plastic SSOP	-40°C to 85°C
LTC4223IGN-2#PBF	LTC4223IGN-2#TRPBF	422312	16-Lead Plastic SSOP	-40°C to 85°C

Consult LTC Marketing for parts specified with wider operating temperature ranges. \*The temperature grade is identified by a label on the shipping container. Consult LTC Marketing for information on non-standard lead based finish parts.

For more information on lead free part marking, go to: <http://www.linear.com/leadfree/>

For more information on tape and reel specifications, go to: <http://www.linear.com/tapeandreel/>

422312f



## ELECTRICAL CHARACTERISTICS

The ● denotes the specifications which apply over the full operating temperature range, otherwise specifications are  $T_A = 25^\circ\text{C}$ ,  $V_{CC} = 3.3\text{V}$ ,  $V_{AUXIN} = 3.3\text{V}$ ,  $V_{12VIN} = 12\text{V}$ , unless otherwise specified. (Note 2)

SYMBOL	PARAMETER	CONDITIONS		MIN	TYP	MAX	UNITS
<b>Supplies</b>							
$V_{DD}$	Input Supply Range	$V_{CC}$	●	2.7		6	V
		AUXIN	●	2.7		6	V
		$12V_{IN}$	●	10		14	V
$I_{DD}$	Input Supply Current	$V_{CC}$	●		0.8	2	mA
		AUXIN	●		0.4	1	mA
		$12V_{IN}$	●		0.6	1	mA
$V_{DD(UVLO)}$	Input Supply Undervoltage Lockout	$V_{CC}$ Rising	●	2.3	2.45	2.6	V
		$V_{AUXIN}$ Rising	●	2.4	2.5	2.6	V
		$V_{12VIN}$ Rising	●	9.4	9.7	10	V
$\Delta V_{DD(UVLO, HYST)}$	Input Supply Undervoltage Lockout Hysteresis	$V_{CC}$	●	40	110	180	mV
		AUXIN	●	70	110	150	mV
		$12V_{IN}$	●	70	110	150	mV
<b>Current Limit</b>							
$\Delta V_{SENSE(CB)}$	Circuit Breaker Trip Sense Voltage, ( $V_{12VIN} - V_{12VSENSE}$ )		●	47.5	50	52.5	mV
$\Delta V_{SENSE(ACL)}$	Active Current Limit Sense Voltage, ( $V_{12VIN} - V_{12VSENSE}$ )		●	54	60	66	mV
$I_{AUX(ACL)}$	AUXOUT Active Current Limit	$V_{AUXOUT} = 0\text{V}$	●	165	240	330	mA
<b>Integrated Switch</b>							
$R_{DS(ON)}$	Switch Resistance ( $V_{AUXIN} - V_{AUXOUT}$ )/ $I_{AUXOUT}$	$I_{AUXOUT} = 150\text{mA}$ (Note 4)	●		0.3	0.5	$\Omega$
<b>Gate Drive</b>							
$\Delta V_{GATE}$	External N-Channel Gate Drive ( $V_{12VGATE} - V_{12VOUT}$ )	(Note 3)	●	4.5	6.2	7.9	V
$I_{GATE(UP)}$	External N-Channel Gate Pull-Up Current	Gate Drive On, $V_{12VGATE} = 0\text{V}$	●	-7	-10	-14	$\mu\text{A}$
$I_{GATE(DN)}$	External N-Channel Gate Pull-Down Current	Gate Drive Off $V_{12VGATE} = 17\text{V}$ , $V_{12VOUT} = 12\text{V}$	●	0.5	1	2	mA
$I_{GATE(FPD)}$	External N-Channel Gate Fast Pull-Down Current	Fast Turn Off $V_{12VGATE} = 17\text{V}$ , $V_{12VOUT} = 12\text{V}$	●	90	160	250	mA
<b>Current Sense</b>							
$G_{12IMON}$	12IMON Pin Gain Ratio $\Delta V_{12IMON}/\Delta(V_{12VIN} - V_{12VSENSE})$	$(V_{12VIN} - V_{12VSENSE}) = (75\text{mV}, 25\text{mV})$	●	30	33	36	V/V
$V_{12IMON}$	12IMON Pin Output Voltage	$(V_{12VIN} - V_{12VSENSE}) = 75\text{mV}$ , $V_{CC} = 2.7\text{V}$	●	2.25	2.475	2.7	V
$\Delta V_{SENSE(MAX)}$	12IMON Pin Maximum Input Sense Voltage		●	82.5			mV
$V_{12IMON(CLP)}$	12IMON Pin Clamp Voltage	$(V_{12VIN} - V_{12VSENSE}) = 150\text{mV}$ , $V_{CC} = 2.7\text{V}$	●	2.9	3.2	3.5	V
$R_{12IMON}$	12IMON Pin Output Resistance	$(V_{12VIN} - V_{12VSENSE}) = 0\text{V}$	●	115	165	215	k $\Omega$
$V_{12IMON(MIN)}$	12IMON Pin Minimum Output Voltage	$(V_{12VIN} - V_{12VSENSE}) = 0\text{V}$	●		0	130	mV
<b>Comparator Inputs</b>							
$V_{PG(TH)}$	Power Good Threshold Voltage	$V_{12VOUT}$ Falling	●	10	10.3	10.6	V
		$V_{AUXOUT}$ Falling	●	2.8	2.885	2.97	V
$V_{PG(HYST)}$	Power Good Hysteresis	$V_{12VOUT}$	●	20	60	110	mV
		$V_{AUXOUT}$	●	5	16	30	mV
$V_{TMR(TH)}$	TIMER Pin Threshold Voltage	$V_{TIMER}$ Rising	●	1.198	1.235	1.272	V
		$V_{TIMER}$ Falling	●	0.15	0.2	0.25	V

# LTC4223-1/LTC4223-2

## ELECTRICAL CHARACTERISTICS

The ● denotes the specifications which apply over the full operating temperature range, otherwise specifications are  $T_A = 25^\circ\text{C}$ ,  $V_{CC} = 3.3\text{V}$ ,  $V_{AUXIN} = 3.3\text{V}$ ,  $V_{12VIN} = 12\text{V}$ , unless otherwise specified. (Note 2)

SYMBOL	PARAMETER	CONDITIONS		MIN	TYP	MAX	UNITS
$I_{TMR(UP)}$	TIMER Pull-Up Current	$V_{TIMER} = 1\text{V}$ , Initial Timing Cycle	●	-7	-10	-13	$\mu\text{A}$
		$V_{TIMER} = 0\text{V}$ , In AUX Fault Mode	●	-7	-10	-13	$\mu\text{A}$
		$V_{TIMER} = 0\text{V}$ , In 12V Fault Mode	●	-140	-200	-260	$\mu\text{A}$
$I_{TMR(DN)}$	TIMER Pull-Down Current	$V_{TIMER} = 2\text{V}$ , No Faults	●	1.3	2	2.6	$\mu\text{A}$
		$V_{TIMER} = 2\text{V}$ , In Reset Mode	●	2	8	16	$\text{mA}$

### Open Drain Outputs

$V_{OL}$	Output Low Voltage ( $\overline{\text{FAULT}}$ , $\overline{12\text{PGOOD}}$ , $\overline{\text{AUXPGOOD}}$ )	$I_{OL} = 3\text{mA}$	●		0.15	0.4	V
$V_{OH}$	Output High Voltage ( $\overline{\text{FAULT}}$ , $\overline{12\text{PGOOD}}$ , $\overline{\text{AUXPGOOD}}$ )	(Note 5)	●	$V_{CC} - 1$			V
$I_{PU}$	Output Pin Pull-Up Current ( $\overline{\text{FAULT}}$ , $\overline{12\text{PGOOD}}$ , $\overline{\text{AUXPGOOD}}$ )	$V_{PU} = 1.5\text{V}$	●	-6	-10	-14	$\mu\text{A}$

### Logic Inputs

$V_{IN(TH)}$	Logic Input Threshold ( $12\text{ON}$ , $\text{AUXON}$ , $\overline{\text{EN}}$ )		●	0.8		2	V
$I_{IN(LEAK)}$	Input Leakage Current ( $12\text{ON}$ , $\text{AUXON}$ )	$V_{IN} = V_{CC}$	●			$\pm 1$	$\mu\text{A}$
$R_{PU}$	$\overline{\text{EN}}$ Pin Pull-Up Resistance		●	60	100	140	$\text{k}\Omega$

### Other Pin Functions

$I_{12VSENSE}$	$12V_{SENSE}$ Pin Input Current	$V_{12VSENSE} = 12\text{V}$	●	10	50	100	$\mu\text{A}$
$I_{12VOUT}$	$12V_{OUT}$ Pin Input Current	Gate Drive On, $V_{12VOUT} = 12\text{V}$	●	20	50	100	$\mu\text{A}$
$R_{OUT(DIS)}$	OUT Pin Discharge Resistance $12V_{OUT}$ $\text{AUXOUT}$	Gate Drive Off	●	400	800	1600	$\Omega$
		$V_{12VOUT} = 6\text{V}$ $V_{AUXVOUT} = 2\text{V}$	●	375	750	1500	$\Omega$

### Propagation Delays

$t_{CB}$	AUX Circuit Breaker Trip Delay	After Power Up	●	12	25	50	$\mu\text{s}$
$t_{PHL(SENSE)}$	Sense Voltage, ( $12V_{IN} - 12V_{SENSE}$ ) High to $12V_{GATE}$ Low	$\Delta V_{SENSE} = 300\text{mV}$ , $C_{12V_{GATE}} = 10\text{nF}$	●		0.5	1	$\mu\text{s}$
		$\Delta V_{SENSE} = 100\text{mV}$ , $C_{12V_{GATE}} = 10\text{nF}$	●		5	12	$\mu\text{s}$
$t_{PHH(AUXON)}$	AUXON High to AUXOUT High		●		15	30	$\mu\text{s}$
$t_{PHH(12ON)}$	$12\text{ON}$ High to $12V_{GATE}$ High		●		30	60	$\mu\text{s}$
$t_{RST(ON)}$	Input Low ( $12\text{ON}$ , $\text{AUXON}$ ) to $\overline{\text{FAULT}}$ High		●		20	40	$\mu\text{s}$
$t_{RST(VCC)}$	$V_{CC}$ Low to $\overline{\text{FAULT}}$ High		●		80	150	$\mu\text{s}$
$t_{PLL(UVLO)}$	$12V_{IN}$ Low to $12V_{GATE}$ Low		●	6	12	18	$\mu\text{s}$
	AUXIN Low to $\overline{\text{AUXPGOOD}}$ High		●	6	12	18	$\mu\text{s}$
$t_{PHL(GATE)}$	$\overline{\text{EN}}$ High to $12V_{GATE}$ Low		●		20	40	$\mu\text{s}$
$t_{PLH(PG)}$	$12V_{OUT}$ Low to $\overline{12\text{PGOOD}}$ High		●		20	40	$\mu\text{s}$
	AUXOUT Low to $\overline{\text{AUXPGOOD}}$ High		●		20	40	$\mu\text{s}$
$t_{P(12IMON)}$	Input Sense Voltage Step to $12\text{IMON}$ Propagation Delay	$\Delta V_{SENSE} = 100\text{mV}$	●		2	6	$\mu\text{s}$

**Note 1:** Stresses beyond those listed under Absolute Maximum Ratings may cause permanent damage to the device. Exposure to any Absolute Maximum Rating condition for extended periods may affect device reliability and lifetime.

**Note 2:** All currents into device pins are positive; all currents out of the device pins are negative. All voltages are referenced to GND unless otherwise specified.

**Note 3:** An internal clamp limits the  $12V_{GATE}$  pin to a minimum of 4.5V above  $12V_{OUT}$ . Driving this pin to voltages beyond the clamp may damage the device.

**Note 4:** For the DFN package, the AUX switch on resistance,  $R_{DS(ON)}$  limit is guaranteed by correlation to wafer test measurements.

**Note 5:** The output pins  $\overline{\text{FAULT}}$ ,  $\overline{12\text{PGOOD}}$  and  $\overline{\text{AUXPGOOD}}$  have an internal pull-up to  $V_{CC}$  of  $10\mu\text{A}$ . However, an external pull-up resistor may be used when faster rise time is required or for  $V_{OH}$  voltages greater than  $V_{CC}$ .

422312f

**TYPICAL PERFORMANCE CHARACTERISTICS**

Specifications are  $T_A = 25^\circ\text{C}$ ,  $V_{CC} = 3.3\text{V}$ ,  $V_{AUXIN} = 3.3\text{V}$ ,  $V_{12VIN} = 12\text{V}$ , unless otherwise specified.

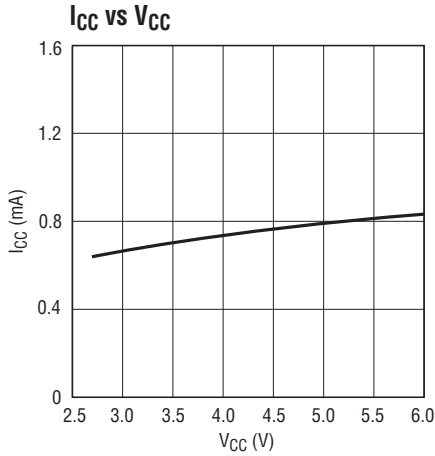

422312 G01

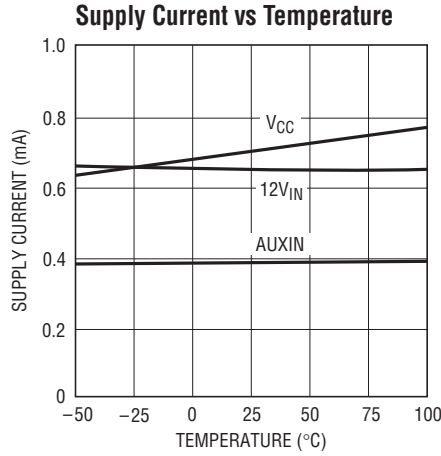

422312 G02

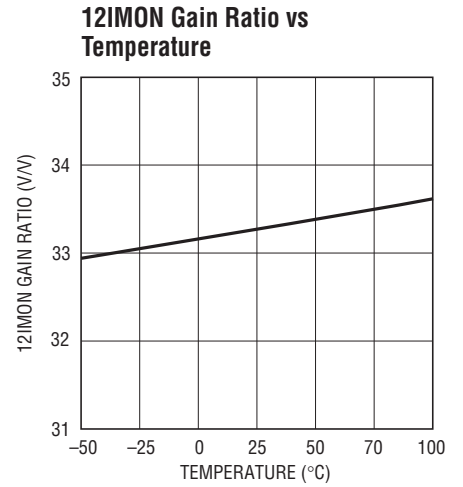

422312 G03

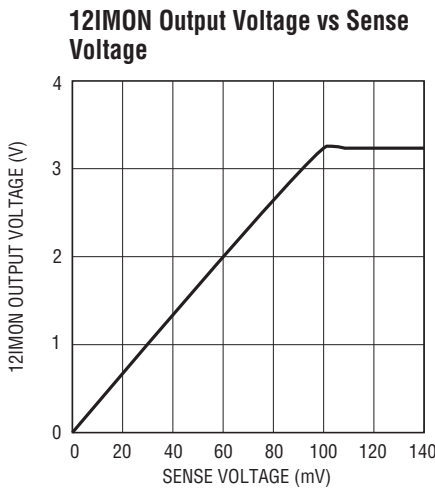

422312 G04

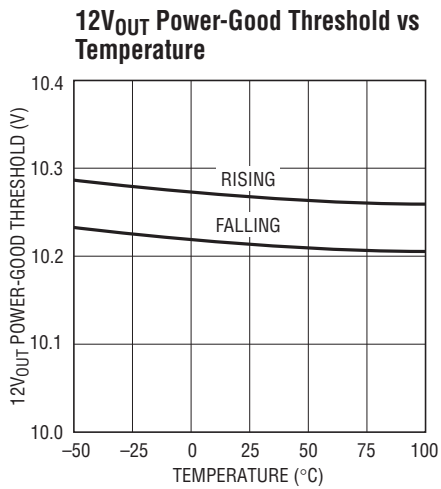

422312 G05

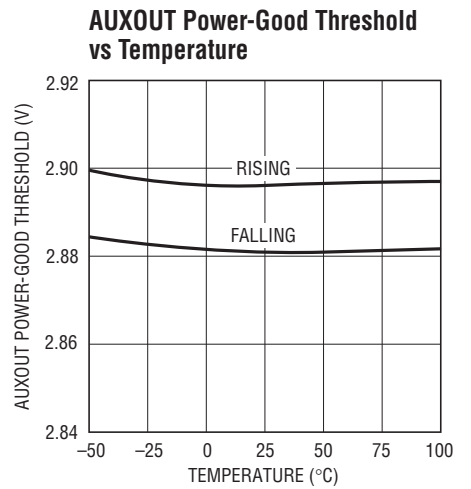

422312 G06

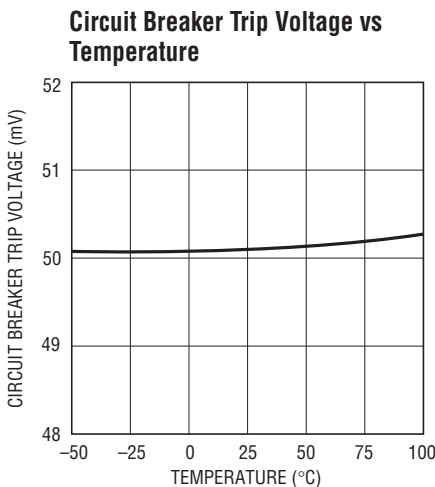

422312 G07

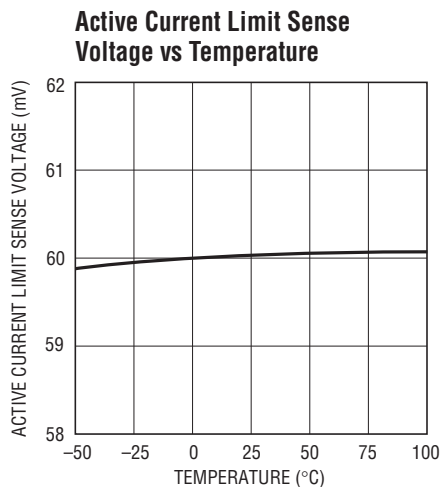

422312 G08

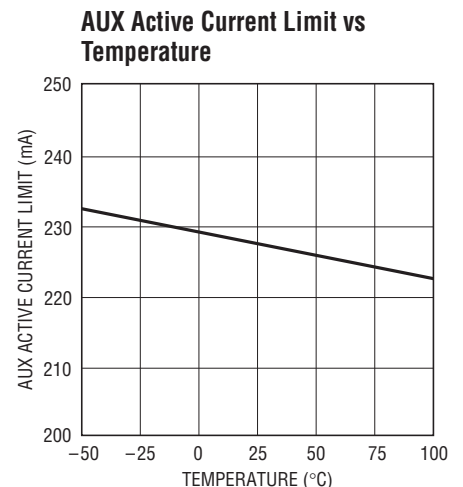

422312 G09

# LTC4223-1/LTC4223-2

## TYPICAL PERFORMANCE CHARACTERISTICS

Specifications are  $T_A = 25^\circ\text{C}$ ,  $V_{CC} = 3.3\text{V}$ ,  $V_{AUXIN} = 3.3\text{V}$ ,  $V_{12VIN} = 12\text{V}$ , unless otherwise specified.

Specifications are  $T_A = 25^\circ\text{C}$ ,  $V_{CC} = 3.3\text{V}$ ,  $V_{AUXIN} = 3.3\text{V}$ ,  $V_{12VIN} = 12\text{V}$ , unless otherwise specified.

**AUX Switch On Resistance vs Temperature**

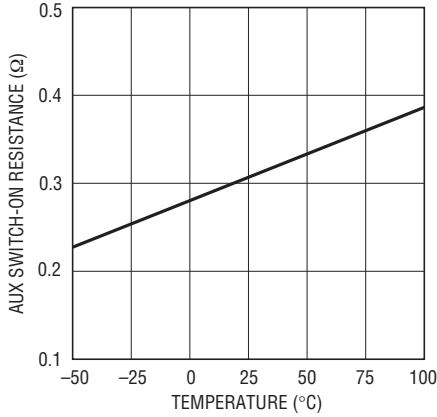

422312 G10

**Gate Drive vs Temperature**

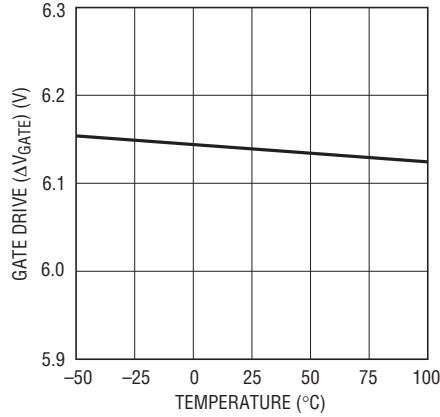

422312 G11

**Gate Drive vs I<sub>GATE</sub>**

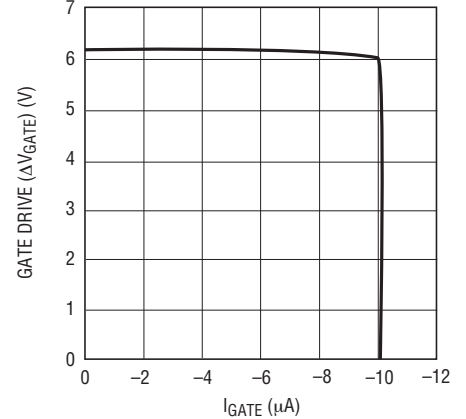

422312 G12

**Gate Pull-Up Current vs Temperature**

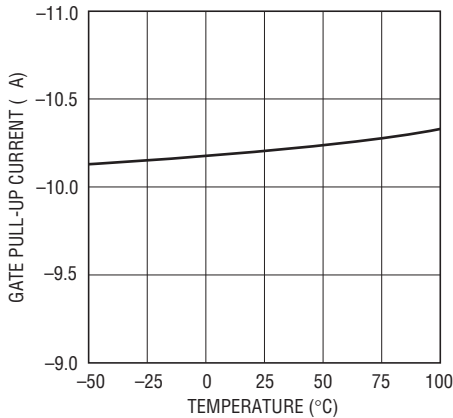

422312 G13

**AUX Circuit Breaker Trip Delay vs Temperature**

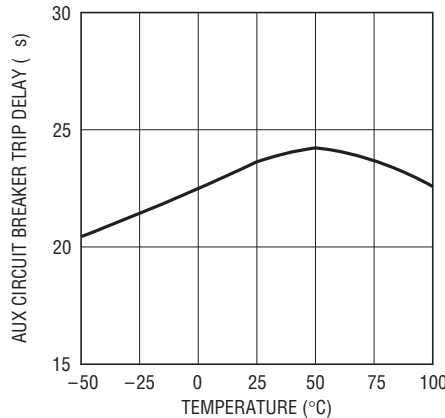

422312 G14

**Active Current Limit Delay vs Sense Voltage**

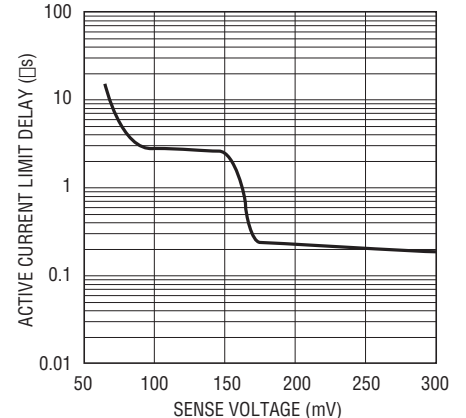

422312 G15

**Gate Fast Pull-Down Current vs Temperature**

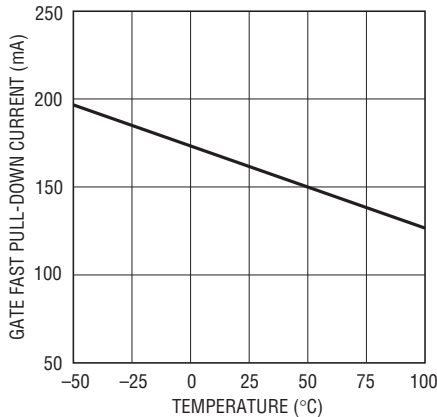

422312 G16

**Output Discharge Resistance vs Temperature**

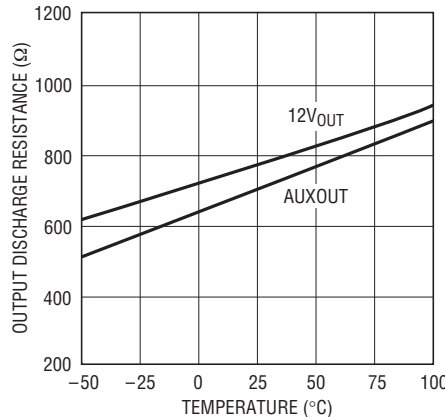

422312 G17

**Logic Input Threshold vs V<sub>CC</sub>**

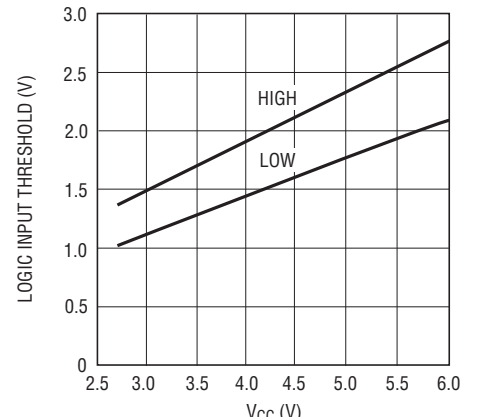

422312 G18

422312f

## PIN FUNCTIONS

**12V<sub>SENSE</sub> (Pin 1):** 12V Current Sense Input. Connect this pin to the output of the current sense resistor. The electronic circuit breaker trips if the voltage across the sense resistor exceeds 50mV for more than a fault filter delay.

**12V<sub>IN</sub> (Pin 2):** 12V Supply Input. Undervoltage lockout disables the 12V supply until the input at 12V<sub>IN</sub> exceeds 9.7V.

**12IMON (Pin 3):** 12V Current Sense Monitoring Output. This pin monitors the sense voltage between 12V<sub>IN</sub> and 12V<sub>SENSE</sub>. The gain ratio between this pin's voltage and the sense voltage is 33.

**12ON (Pin 4):** 12V Supply On Control Digital Input. A rising edge turns on the external N-channel MOSFET if  $\overline{EN}$  is pulled low and a falling edge turns it off. A high-to-low transition on this pin will clear the 12V supply faults.

**AUXIN (Pin 5):** Auxiliary Supply Input. An internal 0.3 $\Omega$  switch is connected between AUXIN and AUXOUT pins. Undervoltage lockout holds the switch off until the input at AUXIN exceeds 2.5V.

**V<sub>CC</sub> (Pin 6):** Bias Supply Input. This pin provides power to the device's internal circuitry and operates from 2.7V to 6V. Undervoltage lockout circuit disables the device until the input at V<sub>CC</sub> exceeds 2.45V. Bypass with 330nF.

**AUXON (Pin 7):** Auxiliary Supply On Control Digital Input. A rising edge turns on the internal switch if  $\overline{EN}$  is pulled low and a falling edge turns it off. A high-to-low transition on both this pin and 12ON pin will clear the auxiliary supply faults.

**GND (Pin 8):** Device Ground.

**TIMER (Pin 9):** Timer Capacitor Terminal. Connect a capacitor between this pin and ground to set a 741ms/ $\mu$ F duration for initial timing cycle, 123ms/ $\mu$ F for AUX current limit during power-up and 6ms/ $\mu$ F duration for 12V current limit before the external MOSFET is turned off.

**$\overline{EN}$  (Pin 10):** Enable Input Intended for Card Presence Detect. Ground this pin to enable the external N-channel MOSFET and internal switch to turn on. If this pin is pulled high, the switches are not allowed to turn on. An internal 100k resistor pulls up this pin. A high-to-low transition will clear faults.

**$\overline{AUXPGOOD}$  (Pin 11):** Auxiliary Supply Power Status Output. Open drain output that is normally pulled high by an internal 10 $\mu$ A current source or an external pull-up resistor to V<sub>CC</sub>. It pulls low when the AUXOUT pin voltage exceeds the power-good threshold of 2.901V.

**AUXOUT (Pin 12):** Auxiliary Supply Output. This pin is the output from the internal switch connected between AUXIN and AUXOUT pins. It signals  $\overline{AUXPGOOD}$  low when it exceeds 2.901V. A 750 $\Omega$  active pull-down discharges AUXOUT to ground when the internal switch is turned off.

**$\overline{FAULT}$  (Pin 13):** Auxiliary and 12V Supply Fault Status Output. Open drain output that is normally pulled high by an internal 10 $\mu$ A current source or an external pull-up resistor to V<sub>CC</sub>. It pulls low when the circuit breaker is tripped due to an overcurrent fault on auxiliary or 12V supply.

**$\overline{12PGOOD}$  (Pin 14):** 12V Supply Power Status Output. Open drain output that is normally pulled high by an internal 10 $\mu$ A current source or an external pull-up resistor to V<sub>CC</sub>. It pulls low when the 12V<sub>OUT</sub> pin voltage exceeds the power-good threshold of 10.36V.

**12V<sub>OUT</sub> (Pin 15):** 12V Gate Drive Return and Power-Good Input. Connect this pin to the source of the external N-channel MOSFET for gate drive return. This pin signals  $\overline{12PGOOD}$  low when it exceeds 10.36V. When the external MOSFET is turned off, 12V<sub>OUT</sub> is discharged to ground through a 800 $\Omega$  active pull-down.

**12V<sub>GATE</sub> (Pin 16):** Gate Drive for 12V Supply External N-Channel MOSFET. An internal 10 $\mu$ A current source charges the gate of the external N-channel MOSFET. An internal clamp limits the gate voltage to 6.2V above 12V<sub>OUT</sub>. A resistor and capacitor network from this pin to ground sets the turn-on rate and compensates the active current limit. During turn-off, a 1mA pull-down current discharges 12V<sub>GATE</sub> to ground. During short circuit or undervoltage lockout, a 160mA pull-down current between 12V<sub>GATE</sub> and 12V<sub>OUT</sub> is activated.

**Exposed Pad (Pin 17, DHD Package):** Exposed pad may be left open or connected to device ground.



FUNCTIONAL DIAGRAM

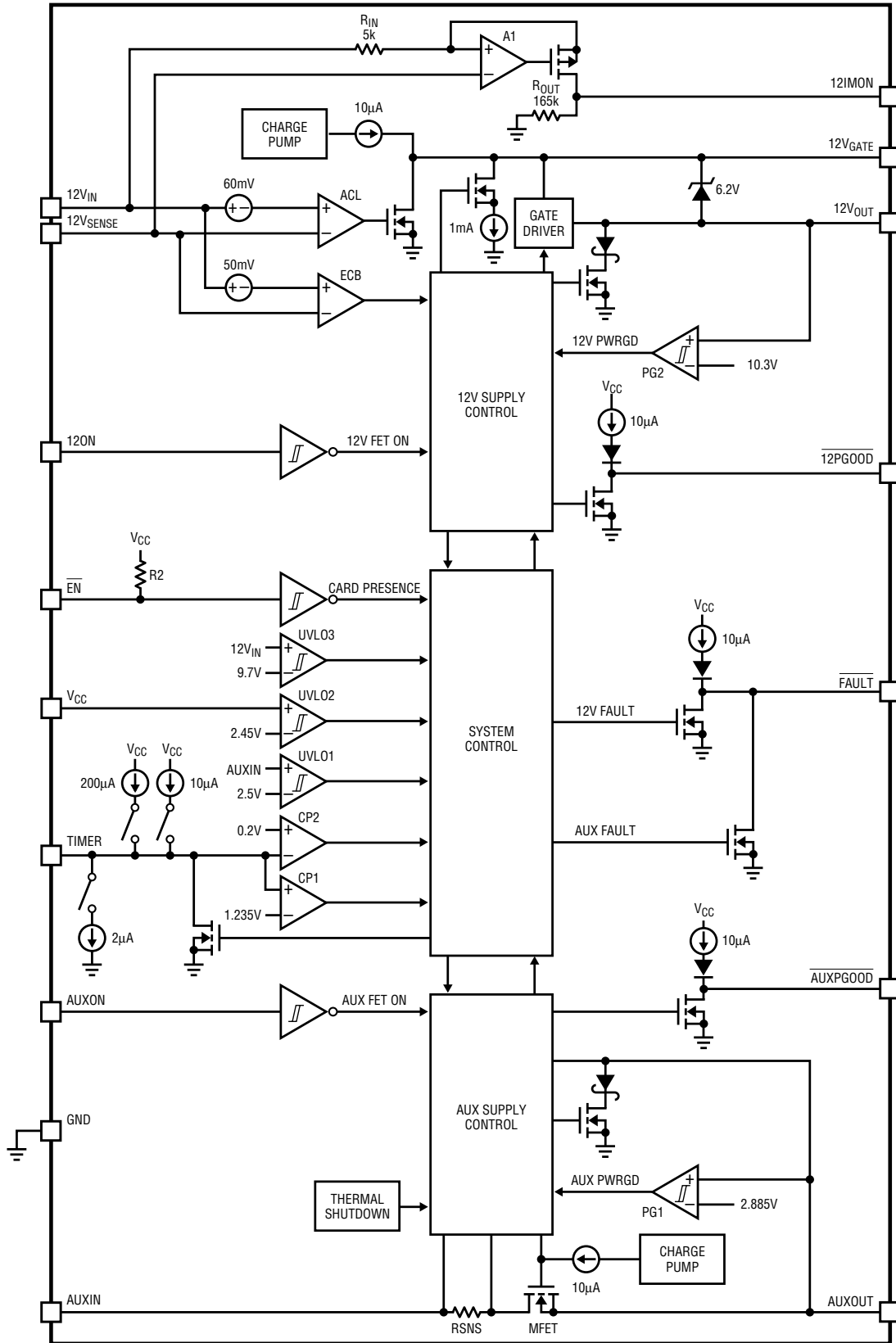

422312 FD

## OPERATION

The LTC4223 is designed to control the power on an Advanced Mezzanine Card (AMC) or MicroTCA backplane, allowing boards to be safely inserted and removed. It controls the 12V main and 3.3V auxiliary power through an external N-channel MOSFET and integrated pass transistor. These two supplies can be turned on and off independently by their respective ON control pins.

If either AUXON or 12ON is pulled high, an initial timing cycle set by the TIMER capacitor value is initiated once all these conditions are met: input supplies out of undervoltage lockout;  $TIMER < 0.2V$  and  $\overline{EN}$  low. At the end of the initial timing cycle, if the AUXON pin is high, the internal pass transistor turns on. It enters into an active current limit loop if the inrush current charging the load capacitor exceeds 240mA. When the load is in current limit, a 10 $\mu A$  pull-up charges the TIMER pin capacitor. If the load capacitor is fully charged and the switch is no longer in current limit before the TIMER reaches 1.235V,  $\overline{AUXPGOOD}$  pulls low indicating that power is good. Otherwise the internal switch turns off and  $\overline{FAULT}$  pulls low when TIMER reaches 1.235V.

If 12ON pin is high at the end of the initial timing cycle, an internal charge pump charges the gate of the external MOSFET with 10 $\mu A$  pull-up. Connecting an external gate capacitor limits the inrush current charging the load capacitor. If the inrush current exceeds its limited current

value, an internal analog current limit (ACL) amplifier servos the gate to force 60mV across the external sense resistor connected between 12VIN and 12V<sub>SENSE</sub> pins. During this period, TIMER pin capacitor is charged by a 200 $\mu A$  pull-up. If the load is fully charged and no longer in current limit before the TIMER reaches 1.235V,  $\overline{12PGOOD}$  pulls low. Otherwise 12V shuts off and  $\overline{FAULT}$  pulls low when TIMER reaches 1.235V.

If an overcurrent fault occurs on the auxiliary supply after power-up, the current is limited to 240mA and after a 25 $\mu s$  delay, the circuit breaker trips and  $\overline{FAULT}$  pulls low. Thermal shutdown protects the internal pass transistor from overheating by shutting it off at 150°C. If an overcurrent fault occurs on the 12V supply, the current is limited to 60mV/R<sub>SENSE</sub>. After a timing cycle delay set by 200 $\mu A$  charging the TIMER capacitor, the circuit breaker trips and  $\overline{FAULT}$  pulls low. An overcurrent fault on the auxiliary supply shuts off 12V; a fault on the 12V supply does not affect the auxiliary supply.

The LTC4223 provides high side current sensing information for the 12V supply at the 12IMON pin. The 12IMON output voltage is 33 times the sense voltage, allowing it to be used with an external ADC.

In the off condition, 12V<sub>OUT</sub> and AUXOUT are discharged to ground by internal N-channel pull downs.

APPLICATIONS INFORMATION

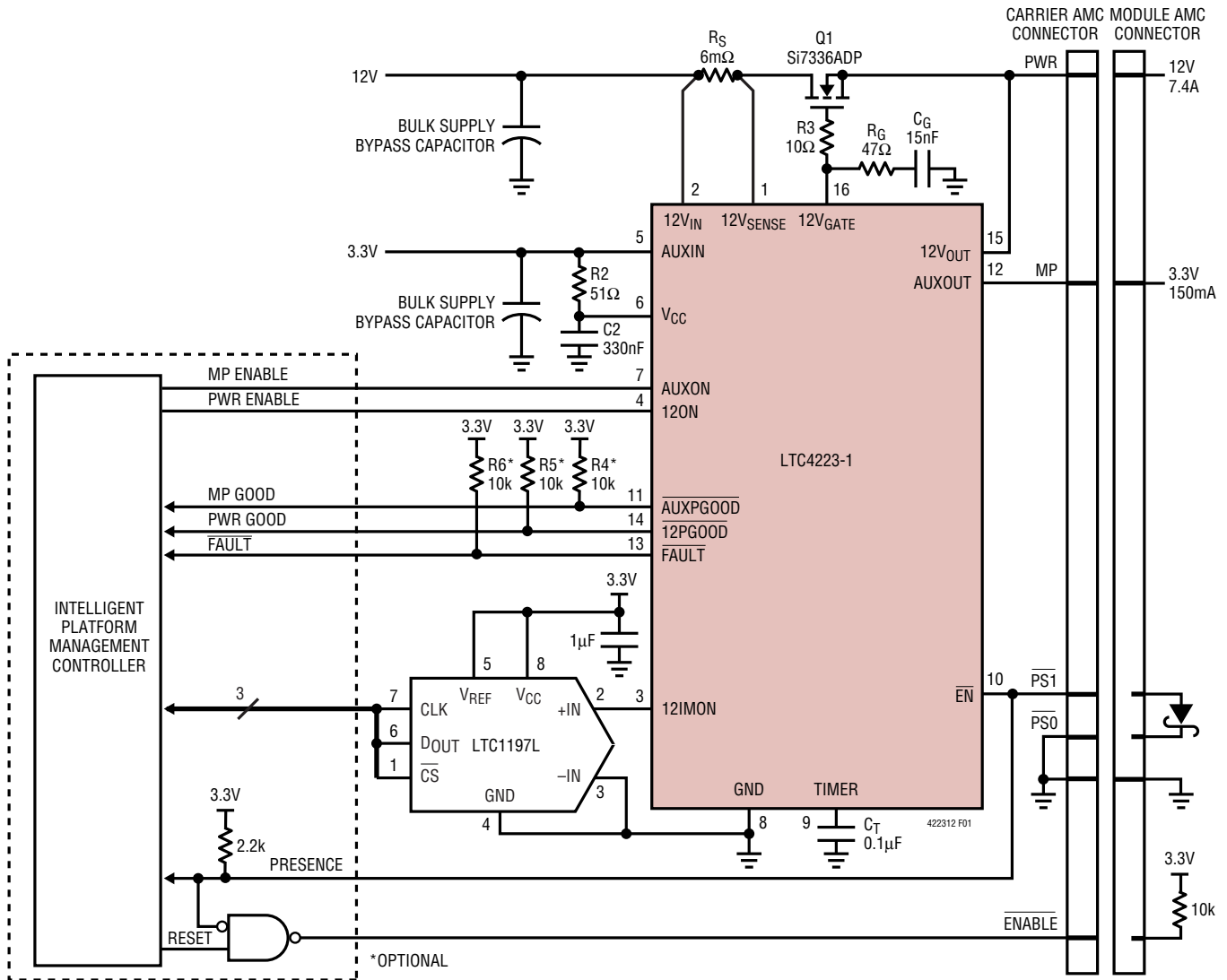

Figure 1. Advanced Mezzanine Card/MicroTCA Application

The typical LTC4223 application is in a Carrier board for Advanced Mezzanine Cards (AMC), delivering 3.3V auxiliary and 12V power to the AMC module. A controller on the Carrier board sequences the turn-on of power supplies and manages the fault and power-good reports from the LTC4223.

The LTC4223 detects board presence during insertion and extraction, allowing power to be delivered in a controlled manner without damaging the connector. The typical LTC4223 application circuit is shown in Figure 1. External component selection is discussed in detail in the Design Example section.

Turn-On Sequence

The power supplies delivered to an AMC module are controlled by the external N-channel pass transistor, Q1 in the 12V power path and an internal pass transistor in the 3.3V auxiliary power path. Sense resistor  $R_S$  monitors the 12V load current for fault detection and current sensing information. GATE capacitor  $C_G$  provides gate slew rate control to limit the inrush current. Resistor  $R_G$  with  $C_G$  compensates the current control loop while R3 prevents parasitic oscillations in Q1.

## APPLICATIONS INFORMATION

Several conditions must be met before the external and internal switches are allowed to turn on. First  $V_{CC}$  and the input supplies ( $12V_{IN}$ ,  $AUXIN$ ) must exceed their undervoltage lockout thresholds. Next  $TIMER$  must be  $<0.2V$  and  $\overline{EN}$  must be pulled low.

Once these conditions are met, a debounce timing cycle is initiated when  $AUXON$  or  $12ON$  pin is toggled from low to high. These two control pins turn on/off the 3.3V auxiliary and 12V supplies. At the end of the debounce cycle, the  $ON$  pins and fault status are checked. If both  $ON$  pins are high and fault is cleared, the 3.3V auxiliary supply starts up first followed by the 12V supply. Note that the turn-on delay for the  $AUXON$  and  $12ON$  pins is  $15\mu s$  and  $30\mu s$ . Figure 2 shows the two supplies turning on in sequence after  $\overline{EN}$  goes low.

By default, the internal pass transistor turns on first if both  $ON$  pins are high and start-up conditions met. The output is current limited at 240mA by its internal ACL amplifier as the load current charging the output capacitor increases. This causes the  $TIMER$  to ramp up with a  $10\mu A$  pull-up. Normally the  $AUXOUT$  voltage exceeds its power-good threshold before  $TIMER$  time-out and then  $AUXPGOOD$  pulls low.

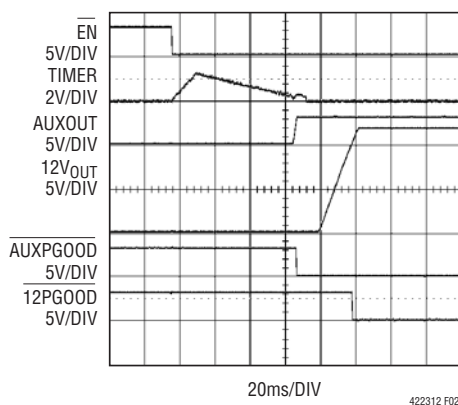

Figure 2. Normal Power-Up Sequence

Once  $AUXOUT$  signals power is good and the  $TIMER$  pin returns to  $<0.2V$ , the external MOSFET is then allowed to turn on by charging up the  $GATE$  with a  $10\mu A$  current source (Figure 2). The voltage at the  $GATE$  pin rises with a slope equal to  $10\mu A/C_G$  and the supply inrush current flowing into the load capacitor  $C_{L1}$  (see Figure 14) is limited to:

$$I_{INRUSH} = \frac{C_{L1}}{C_G} \cdot 10\mu A$$

The 12V output follows the  $GATE$  voltage when the MOSFET turns on. If the voltage across the current sense resistor  $R_S$  becomes too high, the inrush current is limited by the internal current limit circuitry. Once the output,  $12V_{OUT}$  exceeds its power-good threshold,  $12PGOOD$  also pulls low.

If only the  $12ON$  pin is high at the end of debounce cycle, the external MOSFET turns on first. After that, if  $AUXON$  pulls high, the internal switch turns on only after the 12V output signals power is good and  $TIMER < 0.2V$ .

Table 1. 12V and Auxiliary Supply Turn-Off Conditions

CONDITION	RESULT		CLEARED BY
	AUX	12V	
$AUXON$ Goes Low	Turns Off	No Effect	$AUXON$ High
$12ON$ Goes Low	No Effect	Turns Off	$12ON$ High
$\overline{EN}$ Goes High	Turns Off	Turns Off	$\overline{EN}$ Low
UVLO on $V_{CC}$	Turns Off	Turns Off	$V_{CC} > UVLO$
UVLO on $AUXIN$	Turns Off	No Effect	$AUXIN > UVLO$
UVLO on $12V_{IN}$	No Effect	Turns Off	$12V_{IN} > UVLO$
AUX Overcurrent Fault	Turns Off	Turns Off	$AUXON$ and $12ON$ Low, $\overline{EN}$ High-to-Low, UVLO on $V_{CC}$
12V Overcurrent Fault	No Effect	Turns Off	$12ON$ Low, $\overline{EN}$ High-to-Low, UVLO on $V_{CC}$
Thermal Shutdown	Turns Off	Turns Off	$AUXON$ and $12ON$ Low, $\overline{EN}$ High-to-Low, UVLO on $V_{CC}$ , Temperature $< 120^\circ C$



## APPLICATIONS INFORMATION

### Turn-Off Sequence

The switches can be turned off by various conditions and this is summarized in Table 1.

When the 12ON pin goes low, the external switch is turned off with the GATE pin pulled to ground by 1mA current sink. The  $\overline{12PGOOD}$  pin pulls high indicating that power is no longer good, while an internal N-channel transistor discharges the output to ground. Similarly, when the AUXON pin goes low, the internal switch is turned off,  $\overline{AUXPGOOD}$  pulls high while its output is discharged to ground through an internal N-channel transistor. Figure 3 shows the two supplies being turned off by  $\overline{EN}$  going high.

### Card Presence Detect

In an AMC system,  $\overline{PS1}$  and  $\overline{PS0}$  signals are used to detect the presence of a card upon insertion or removal. Normally  $\overline{PS1}$  is connected to the  $\overline{EN}$  pin with a pull-up resistor. If AUXON or 12ON is high when the  $\overline{EN}$  pin goes low, indicating a board insertion, a timing cycle for contact debouncing is initiated. Upon insertion, any bounces on the  $\overline{EN}$  pin will re-start the timing cycle. When TIMER finally reaches its threshold during ramp up, the fault latches will be cleared. If the  $\overline{EN}$  pin remains low at the end of the timing cycle, the switches are allowed to turn on.

If the  $\overline{EN}$  pin is toggled from low to high, indicating board removal, all the switches will be turned off after a 20 $\mu$ s delay. Any latched faults will not be cleared. However, removing the card could cause the  $\overline{EN}$  pin voltage to bounce, clearing the fault latches undesirably. This is prevented by blanking

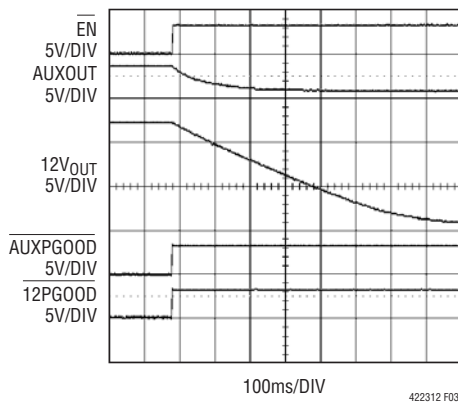

Figure 3. Normal Power-Down Sequence

the bounces internally with a TIMER ramp up period given by  $C_T \cdot 123[\text{ms}/\mu\text{F}]$  as shown in Figure 4.

### Timer Functions

An external capacitor  $C_T$  connected from the TIMER pin to ground is used to perform several functions.

1. Ignore contact debouncing during card insertion when the device is enabled. The debounce cycle is given by ramping up  $C_T$  with 10 $\mu$ A current to TIMER high threshold (1.235V) and then ramping down with 2 $\mu$ A current to below TIMER low threshold (0.2V). This gives an average debounce cycle time of  $C_T \cdot 741[\text{ms}/\mu\text{F}]$ . After that, if any ON pin is pulled high and  $\overline{EN}$  pin is low, the switches can be turned on.
2. Blanking contact bounce on the  $\overline{EN}$  pin that might trigger unwanted fault clearing during card removal. The blanking time is given by  $C_T \cdot 123[\text{ms}/\mu\text{F}]$ .
3. Fault filtering during auxiliary supply power-up in analog current limit. TIMER pulls up with 10 $\mu$ A and pulls down with 2 $\mu$ A. The filter time is given by  $C_T \cdot 123[\text{ms}/\mu\text{F}]$ .
4. 12V supply fault filtering during and after power-up in analog current limit. TIMER pulls up with 200 $\mu$ A and pulls down with 2 $\mu$ A. The filter time is given by  $C_T \cdot 6[\text{ms}/\mu\text{F}]$ .
5. For cooling off during an auto-retry cycle after an overcurrent fault on auxiliary or 12V supply (LTC4223-2). The cool-off time is given by  $C_T \cdot 1482[\text{ms}/\mu\text{F}]$  after an auxiliary supply fault and  $C_T \cdot 1358[\text{ms}/\mu\text{F}]$  after a 12V supply fault.

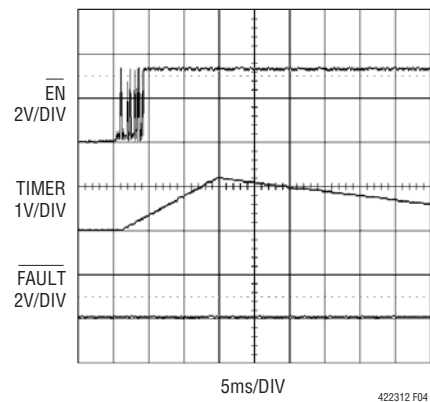

Figure 4. Debouncing by TIMER during Card Removal

## APPLICATIONS INFORMATION

As the TIMER capacitor is used for fault filtering during power-up for both the auxiliary and 12V supplies, only one supply can be started up at any one time. The other supply waits until the power-good signal is generated by the powering-up supply and the TIMER pin voltage falls below 0.2V. By default, the 3.3V auxiliary supply starts up first if both AUXON and 12ON are high at the end of the debounce cycle.

Whenever both AUXON and 12ON are pulled low, the device is in reset mode and TIMER capacitor is discharged to ground by an 8mA current sink.

### Thermal Shutdown

The internal 3.3V auxiliary supply switch is protected by thermal shutdown. If the switch's temperature reaches 150°C, the aux switch will shut off immediately and  $\overline{\text{FAULT}}$  will pull low. The external 12V supply switch also turns off. The switches are allowed to turn on again by cycling both the AUXON and 12ON pins low then high after the internal switch's temperature falls below 120°C.

### Overcurrent Fault

The LTC4223 features an adjustable current limit with circuit breaker function that protects the external MOSFET against

short circuits or excessive load current on 12V supply. The voltage across the external sense resistor is monitored by the analog current limit (ACL) amplifier and the electronic circuit breaker (ECB) comparator. If an overcurrent fault occurs that causes the sense voltage to reach the ACL threshold (60mV), the ACL amplifier regulates the MOSFET to prevent any further increase in current. This overcurrent condition results in a sense voltage that exceeds the ECB threshold. As a result, the TIMER capacitor is charged by a 200 $\mu$ A current. If the condition persists, the TIMER pin voltage will reach its threshold (1.235V). When this occurs, the  $\overline{\text{FAULT}}$  pin pulls low and a 1mA current pulls the GATE pin to ground causing the MOSFET to turn off. The circuit breaker time delay, the time required for the TIMER pin capacitor to charge from ground to the TIMER pin threshold, is given by  $C_T \cdot 6[\text{ms}/\mu\text{F}]$ .

After the MOSFET turns off, the TIMER pin capacitor discharges with a 2 $\mu$ A pull-down current. For the auto-retry version (LTC4223-2), if the TIMER discharges to below 0.2V, a new start-up cycle will begin. The TIMER starts ramping up and clears faults when it exceeds 1.235V; thereafter it ramps down (see the section on Auto-Retry for details). Figure 5 shows an overcurrent fault on the 12V output.

In the event of a severe short-circuit fault on 12V output as shown in Figure 6, the output current can surge to tens of amperes. The LTC4223 responds within a very short time to bring the current under control by pulling the MOSFET's GATE-to-SOURCE pin voltage down to zero volts. Thereafter, the GATE of the MOSFET recovers rapidly due to the  $R_G/C_G$  compensation network and enters into active current limiting until the TIMER times out. Due to parasitic supply lead inductance, an input supply without any bypass capacitor will collapse during the high current surge and then spike upwards when the current is interrupted. An input supply transient protection network comprising of Z1, R1 and C1 shown in Figure 13 is recommended if there is no input capacitance.

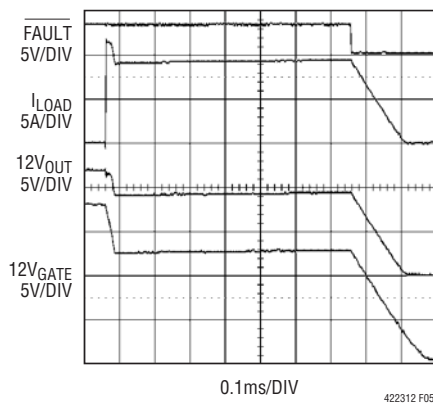

Figure 5. Overcurrent Fault on 12V Output

## APPLICATIONS INFORMATION

There are two different modes of fault time-out for the 3.3V auxiliary supply: adjustable delay through TIMER capacitor during power-up when  $\overline{\text{AUXPGOOD}}$  not asserted; fixed 25 $\mu\text{s}$  delay after power-up when  $\overline{\text{AUXPGOOD}}$  asserted low. Under the situation whereby AUXON toggles low then high for short duration after power-up while  $\overline{\text{AUXPGOOD}}$  still pulling low due to output load capacitor, 25 $\mu\text{s}$  fault time-out applies.

When the auxiliary supply is powered up into an output short, the ACL amplifier will regulate the gate of the internal pass transistor to produce 240mA output current. At this time a 10 $\mu\text{A}$  pull-up current starts charging up the TIMER pin capacitor until it exceeds its threshold (1.235V). The internal pass transistor then turns off and  $\overline{\text{FAULT}}$  pulls low. Thereafter, the TIMER is discharged by a 2 $\mu\text{A}$  pull-down current. The fault filter delay is given by  $C_T \cdot 123[\text{ms}/\mu\text{F}]$ .

After a successful power-up cycle, the ACL amplifier protects the auxiliary supply from overcurrent by pulling down the gate of the internal pass transistor rapidly as shown in Figure 7. Thereafter, the gate recovers and servos the output current to about 240mA for 25 $\mu\text{s}$  before pulling down to ground gently, turning the transistor off. At this time,  $\overline{\text{FAULT}}$  pulls low and the 12V external MOSFET is also turned off by the 1mA GATE pull-down current.

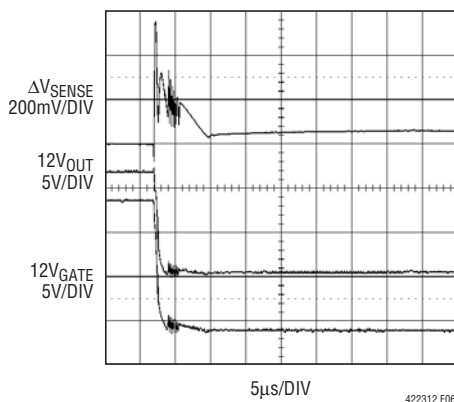

Figure 6. Short-Circuit Fault on 12V Output

Whenever the 3.3V auxiliary supply trips off due to an overcurrent fault, the 12V supply also shuts off. The auxiliary supply is, however, unaffected by faults on the 12V supply. In either case  $\overline{\text{FAULT}}$  latches low when the affected channels turn off, and  $\overline{\text{FAULT}}$  is cleared by toggling the ON pins. Faults are cleared automatically in the LTC4223-2 auto-retry version.

If there is significant supply lead inductance, a severe output short may collapse the input to ground before the LTC4223 can bring the current under control. In this case the undervoltage lockout will activate after a 12 $\mu\text{s}$  filter delay, and pull the gate down. Then the ACL amplifier will take control and regulate the output in active current limit. Under this situation, the fault time-out is set by TIMER delay instead of 25 $\mu\text{s}$  filter delay.

### Undervoltage Fault

An undervoltage fault occurs if either AUXIN or 12VIN falls below its undervoltage threshold for longer than 12 $\mu\text{s}$ . This turns off the affected supply's switch instantly, but does not clear the fault latches. Further, an undervoltage fault on one supply does not affect the operation of the other supply. If the bias supply input,  $V_{CC}$  falls below its UVLO threshold for more than 80 $\mu\text{s}$ , all supply switches are turned off and the fault latches are cleared. Operation resumes from a fresh start-up cycle when  $V_{CC}$  is restored.

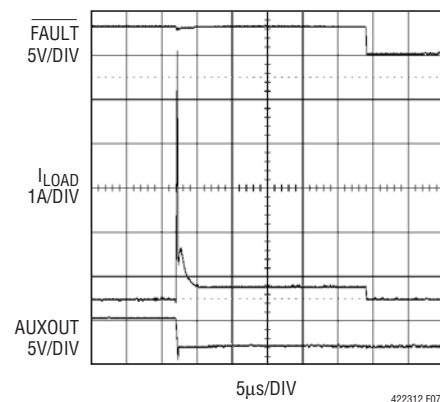

Figure 7. Short-Circuit Fault on 3.3V<sub>AUX</sub> Output

## APPLICATIONS INFORMATION

### Power-Good Monitor

Internal circuitry monitors the output voltages, AUXOUT and 12V<sub>OUT</sub>. The power-good status is reported via their respective open drain outputs, AUXPGOOD and 12PGOOD. Several conditions must be met before the power-good outputs assert low.

1. The monitored output should be above its power-good threshold and hysteresis.
2. The input supply is above undervoltage lockout.
3.  $\overline{\text{EN}}$  is low.
4. The associated ON pin is high.
5. Thermal shutdown is not activated.

If any of the supply outputs falls below its power-good threshold for more than 20 $\mu$ s, the respective power-good output will be pulled high by the external pull-up resistor or internal 10 $\mu$ A pull-up.

### Resetting Faults (LTC4223-1)

Any supply faults tripping the circuit breaker are latched and  $\overline{\text{FAULT}}$  asserts low. For the latched-off version (LTC4223-1), to reset a fault latch due to overcurrent or thermal shutdown on auxiliary supply, pull both AUXON and 12ON pins low together for at least 100 $\mu$ s, after which the  $\overline{\text{FAULT}}$  will go high. Toggling both the ON pins high together again initiates the debounce timing cycle, thereafter the auxiliary supply starts up first followed by 12V supply. To skip the debounce timing cycle, first pull only AUXON low then high for at least 50 $\mu$ s before toggling 12ON low then high. The fault latch clears on the falling edge of 12ON and the auxiliary supply powers up. Thereafter, the 12V supply powers up if 12ON pulls high.

To reset a fault on the 12V supply and re-start the output, toggle only the 12ON pin low and then high again. Toggling the  $\overline{\text{EN}}$  pin high then low again or bringing the bias input, V<sub>CC</sub> below its UVLO threshold for more than 100 $\mu$ s will initiate the debounce timing cycle and reset all fault latches before power-up. Bringing AUXIN or 12V<sub>IN</sub> below its undervoltage threshold will not reset the fault latches. For the auto-retry version (LTC4223-2), the latched fault will be cleared automatically after a cool-off timing cycle.

### Auto-Retry after a Fault (LTC4223-2)

At time point 1 in Figure 8, if a fault latched-off the 3.3V auxiliary supply after power-up, a cool-off cycle begins. The TIMER capacitor charges up to 1.235V with a 10 $\mu$ A current and then discharges with a 2 $\mu$ A current to 0.2V at time point 3. This is followed by a debounce timing cycle whereby the fault latch is cleared, and  $\overline{\text{FAULT}}$  pulls high when TIMER reaches its threshold at time point 4. At the end of debounce cycle, the internal switch is allowed to turn on. If the output short persists, the auxiliary supply powers up into a short with active current limiting. At time point 7, the fault filter delay begins with TIMER ramping up with a 10 $\mu$ A current. If the TIMER times out at time point 8,  $\overline{\text{FAULT}}$  will be pulled low and a new cool-off cycle begins with TIMER ramping down with a 2 $\mu$ A current. The whole process repeats itself until the output-short is removed.

In Figure 9, a fault latches off the 12V supply at time point 1; a cool-off cycle begins by discharging the TIMER capacitor with 2 $\mu$ A current from 1.235V to 0.2V threshold. At time point 2 a new debounce timing cycle is initiated where the fault latch is cleared, and  $\overline{\text{FAULT}}$  pulls high when TIMER reaches its threshold at time point 3. At the end of the debounce cycle, the 12V GATE is allowed to start up. If the output short persists, the 12V supply powers up into a short with active current limiting. At time point 6, the fault filter delay begins with TIMER ramping up with a 200 $\mu$ A current. The TIMER times out at time point 7,  $\overline{\text{FAULT}}$  pulls low and a new cool-off cycle begins with TIMER ramping down with a 2 $\mu$ A current. The whole process repeats itself until the output-short is removed.

The auto-retry duty cycle is given by:

$$\text{DutyCycle} = \frac{t_{\text{FILTER}} \cdot 100\%}{t_{\text{COOL}} + t_{\text{DEBOUNCE}} + t_{\text{FILTER}}}$$

For example, if TIMER capacitor, C<sub>T</sub> = 0.1 $\mu$ F, the auto-retry duty cycle for auxiliary and 12V supply is 6.5% and 0.5% respectively.



## APPLICATIONS INFORMATION

### GATE Pin Voltage

The gate drive at  $12V_{GATE}$  is compatible with any logic level MOSFET. The guaranteed range of gate drive is 4.5V to 7.9V, with a typical of 6.2V.

### Active Current Loop Compensation

The compensation network consisting of resistor  $R_G$  and gate slew rate control capacitor  $C_G$  stabilizes the internal active current limit circuit. The value of  $C_G$  is selected based on the inrush current allowed. The suggested value for  $R_G$  is  $47\Omega$ . The value of  $C_G$  should be  $\leq 330nF$  and  $R_G$  is between  $10\Omega$  and  $100\Omega$  for optimum performance.

### High Side Current Sense

The 12V load current is monitored via the voltage across an external sense resistor. The LTC4223 features a high side current sense amplifier that translates the sense voltage from the positive rail to the negative rail using a resistor ratio of 33 times. The output voltage at 12IMON pin can

then be fed into an LTC1197L ADC as shown in Figure 10 for data conversion. The current sense information can be used by the system controller to manage the power budget allocated to the modules on the card. Full scale input to the current sense amplifier is 82.5mV, corresponding to an output of about 2.7V. If the input exceeds 100mV, the output clamps at 3.2V.

### V<sub>CC</sub> Supply Filtering

The internal circuitry of the LTC4223 is powered from the  $V_{CC}$  pin. Bypass  $V_{CC}$  with at least 330nF to ground. If  $V_{CC}$  is derived from the same supply as is AUXIN, include a decoupling resistor as shown in Figure 11. This RC network allows the  $V_{CC}$  pin to ride out supply glitches caused by short circuits on the auxiliary output or on adjacent boards, thus preventing an undervoltage lockout condition on  $V_{CC}$ . Since the absolute maximum rating for  $V_{CC}$  is 7V as compared to 10V for AUXIN, select R2 and C2 to keep the peak voltage seen by  $V_{CC}$  below 7V during any voltage spikes.

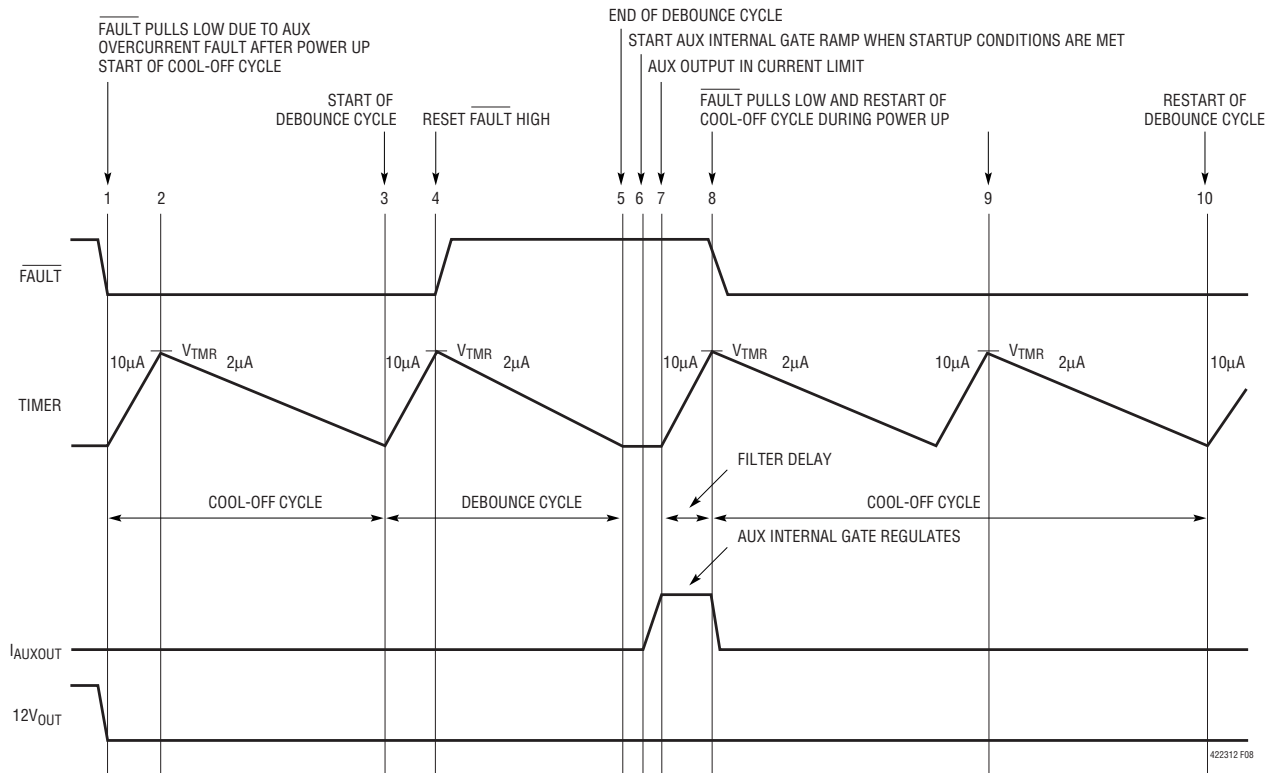

Figure 8. Auto-Retry after AUX Overcurrent Fault

## APPLICATIONS INFORMATION

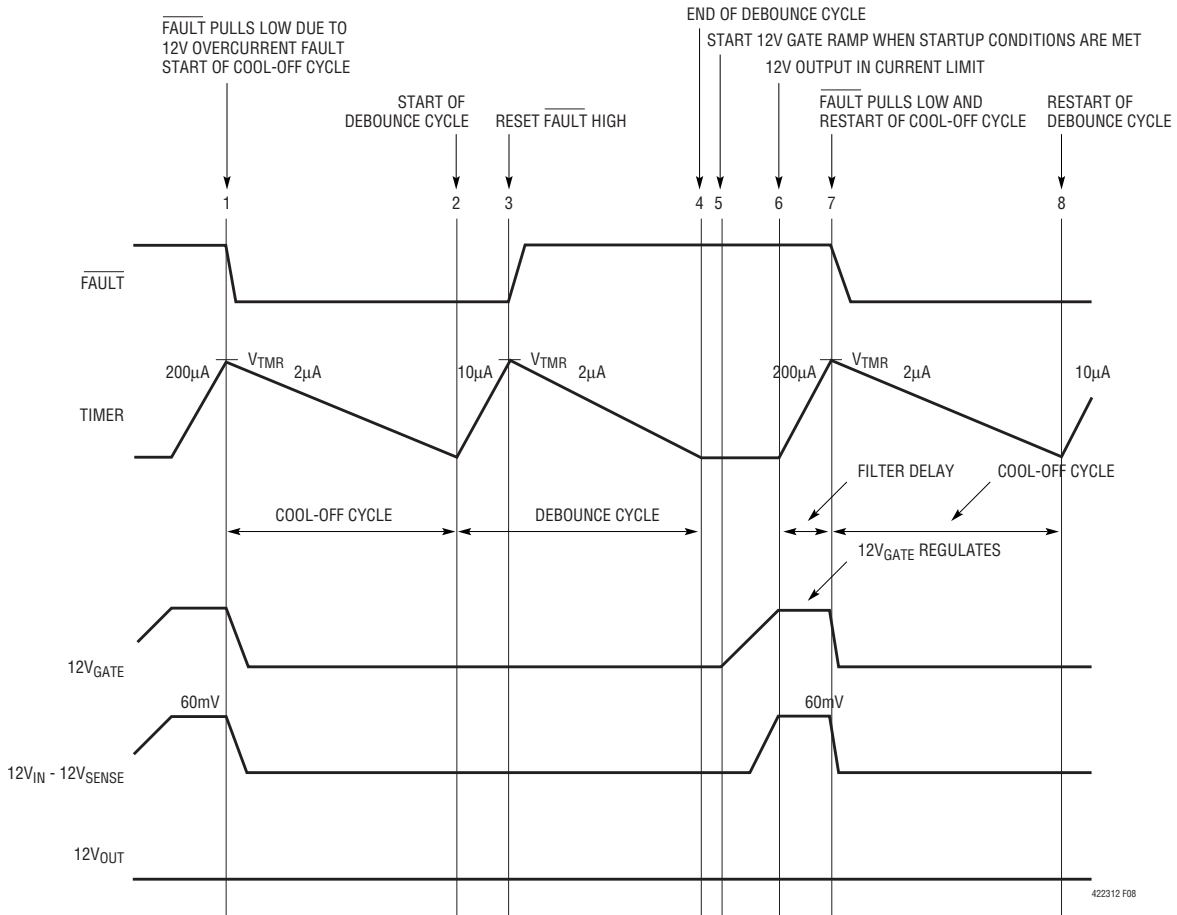

Figure 9. Auto-Retry after 12V Overcurrent Fault

### Supply Transient Protection

The supply inputs, AUXIN and 12V<sub>IN</sub> are fed directly from the regulated output of the backplane supply, where bulk bypassing assures a spike-free operating environment. In other applications where the bulk bypassing is located far from the LTC4223, spikes generated during output short circuit events could exceed the absolute maximum ratings for AUXIN and 12V<sub>IN</sub>. To minimize such spikes, use wider traces or heavier trace plating to reduce the power trace inductance. Also, bypass locally with a 10µF electrolytic and 100nF ceramic, or alternatively clamp the input with a transient voltage suppressor (Z1, Z2) as shown in Figure 13. A 10Ω, 100nF snubber damps the response and eliminates ringing. A recommended layout of the 12V transient protection devices Z1, R1 and C1 around the LTC4223 is shown in Figure 12.

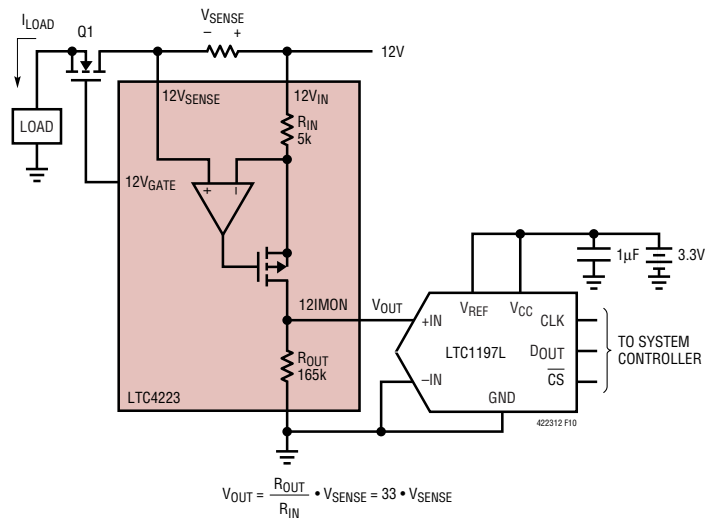
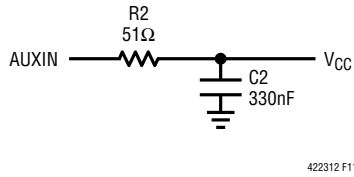

Figure 10. High Side Current Sense with LTC1197L ADC

## APPLICATIONS INFORMATION



**Figure 11. RC Network for V<sub>CC</sub> Filtering**

### PCB Layout Considerations

For proper operation of the LTC4223's circuit breaker, Kelvin-connection to the sense resistor is strongly recommended. The PCB layout should be balanced and symmetrical to minimize wiring errors. In addition, the PCB layout for the sense resistor and the power MOSFET should include good thermal management techniques for optimal device power dissipation. A recommended PCB layout for the 12V sense resistor and the power MOSFET is illustrated in Figure 12.

In applications where load current exceeds 10A, wide PCB traces are recommended to minimize resistance and temperature rise. The suggested trace width for 1 oz copper foil is 0.03" for each ampere of DC current to keep PCB trace resistance, voltage drop and temperature rise to a minimum. Note that the sheet resistance of 1 oz copper foil is approximately 0.5mΩ/square, and voltage drops due to trace resistance add up quickly in high current applications.

In most applications, it will be necessary to use plated-through via to make circuit connections from component layers to power and ground layers internal to the PCB. For 1 oz copper foil plating, a general rule is 1A of DC current per via. Consult your PCB fabrication facility for design rules pertaining to other plating thicknesses.

It is important to place the V<sub>CC</sub> bypass capacitor C2 as close as possible between V<sub>CC</sub> and GND. The transient voltage suppressors Z1 and Z2 are also placed between the supply inputs and ground using short wide traces.

### Design Example

As a design example, consider the AMC Hot Swap application shown earlier in Figure 1 with the power supply requirements given in Table 2.

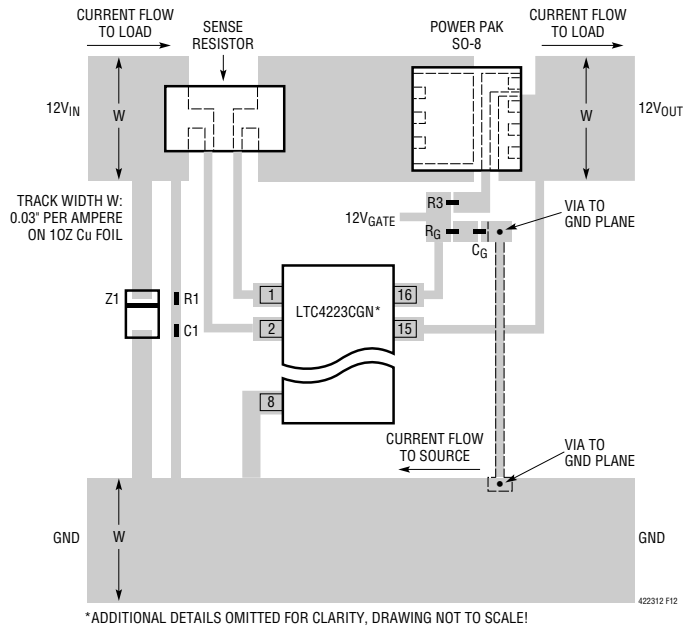

**Figure 12. Recommended Layout for Power MOSFET, Sense Resistor and GATE Components on 12V Rail**

The first step is to select the appropriate value of R<sub>SENSE</sub> for the 12V supply. Calculating R<sub>SENSE</sub> value is based on the maximum load current and the lower limit for the circuit breaker threshold, ΔV<sub>SENSE(CB)(MIN)</sub>.

$$R_{SENSE} = \frac{\Delta V_{SENSE(CB)(MIN)}}{I_{LOAD(MAX)}} = \frac{47.5mV}{7.4A} = 6m\Omega$$

If a 1% tolerance is assumed for the 6mΩ sense resistor, the minimum and maximum circuit breaker trip current is calculated as follows:

**Table 2. AMC Power Supply Requirements**

SUPPLY VOLTAGE	MAXIMUM LOAD CURRENT	MAXIMUM LOAD CAPACITANCE
12V	7.4A	800μF
3.3V <sub>AUX</sub>	150mA	150μF

**Table 3. MicroTCA Power Supply Requirements**

SUPPLY VOLTAGE	MAXIMUM LOAD CURRENT	MAXIMUM LOAD CAPACITANCE
12V	7.6A	1600μF
3.3V <sub>AUX</sub>	150mA	150μF

## APPLICATIONS INFORMATION

$$I_{\text{TRIP(MIN)}} = \frac{\Delta V_{\text{SENSE(CB)(MIN)}}}{R_{\text{SENSE(MAX)}}} = \frac{47.5\text{mV}}{6.06\text{m}\Omega} = 7.8\text{A}$$

$$I_{\text{TRIP(MAX)}} = \frac{\Delta V_{\text{SENSE(CB)(MAX)}}}{R_{\text{SENSE(MIN)}}} = \frac{52.5\text{mV}}{5.94\text{m}\Omega} = 8.8\text{A}$$

For proper operation,  $I_{\text{TRIP(MIN)}}$  must exceed the maximum load current with margin, so  $R_{\text{SENSE}} = 6\text{m}\Omega$  should suffice for the 12V supply.

The second step is to determine the TIMER capacitance based on the time required to charge up completely the output load capacitor on auxiliary supply in active current limit without exceeding the fault filter delay. The worst-case start-up time is calculated using the minimum active current limit value for the auxiliary supply.

$$t_{\text{STUP(AUX)}} = \frac{C_{\text{L2}} \cdot 3.3\text{V}_{\text{AUX}}}{I_{\text{AUX(ACL)(MIN)}}} = \frac{150\mu\text{F} \cdot 3.3\text{V}}{165\text{mA}} = 3\text{ms}$$

For a start-up time of 3ms with a 2x safety margin, the TIMER capacitance is calculated as:

$$C_{\text{T}} = \frac{2 \cdot t_{\text{STUP(AUX)}}}{123[\text{ms}/\mu\text{F}]} = \frac{6\text{ms}}{123[\text{ms}/\mu\text{F}]} \cong 0.05\mu\text{F}$$

Considering the tolerances for the TIMER charging rate and capacitance, a value of  $0.1\mu\text{F}$  ( $\pm 10\%$ ) for  $C_{\text{T}}$  should suffice.

Since the TIMER charging rate during fault time-out is 20 times faster for the 12V supply as compared to the auxiliary supply during start-up, this scheme ensures that the external MOSFET will not overheat under any output-short condition. The fault filter delay for the 12V supply is given by  $0.1\mu\text{F} \cdot 6[\text{ms}/\mu\text{F}] = 600\mu\text{s}$  versus 12ms for the auxiliary supply.

The next step is to verify that the thermal ratings of the selected external MOSFET for the 12V supply aren't exceeded during power-up or an output-short.

Assuming the MOSFET dissipates power only due to inrush current charging the load capacitor, the energy dissipated in the MOSFET during power-up is the same as that stored into the load capacitor. The average power dissipated in the MOSFET is given by:

$$P_{\text{AVG}} = \frac{C_{\text{L1}} \cdot 12V_{\text{OUT}}^2}{2 \cdot t_{\text{CHARGE}}}$$

The inrush current can be limited by using the GATE capacitance ( $C_{\text{G}}$ ) so that the power dissipated in the MOSFET is well within its safe operating area (SOA). For  $I_{\text{GATE}} = 10\mu\text{A}$  and  $C_{\text{L1}} = 800\mu\text{F}$ , we choose  $C_{\text{G}} = 15\text{nF}$  to set the inrush current to 0.5A.

$$I_{\text{INRUSH}} = \frac{C_{\text{L1}} \cdot I_{\text{GATE}}}{C_{\text{G}}} = 0.5\text{A}$$

$$t_{\text{CHARGE}} = \frac{C_{\text{L1}} \cdot 12V_{\text{OUT}}}{I_{\text{INRUSH}}} = 19\text{ms}$$

This results in  $P_{\text{AVG}} = 3\text{W}$  and the MOSFET selected must be able to tolerate 3W for 19ms. The increase in steady state junction temperature due to power dissipated in the MOSFET is  $\Delta T = P_{\text{AVG}} \cdot Z_{\text{th}}$  where  $Z_{\text{th}}$  is the thermal impedance.

Under this condition, the Si7336ADP datasheet's Transient Thermal Impedance plot indicates that the junction temperature will increase by  $2.4^\circ\text{C}$  using  $Z_{\text{thJC}} = 0.8^\circ\text{C/W}$  (single pulse).

The duration and magnitude of the power pulse that results during a short-circuit condition on the 12V output are a function of the TIMER capacitance and LTC4223's analog current limit. The short-circuit duration is given as  $0.1\mu\text{F} \cdot 6[\text{ms}/\mu\text{F}] = 600\mu\text{s}$  for  $C_{\text{T}} = 0.1\mu\text{F}$ . The maximum short-circuit current is calculated using the maximum analog current limit threshold,  $\Delta V_{\text{SENSE(ACL)(MAX)}}$  and minimum  $R_{\text{SENSE}}$  value.

$$I_{\text{SHORT(MAX)}} = \frac{\Delta V_{\text{SENSE(ACL)(MAX)}}}{R_{\text{SENSE(MIN)}}} = \frac{66\text{mV}}{5.94\text{m}\Omega} = 11\text{A}$$

So the maximum power dissipated in the MOSFET is  $11\text{A} \cdot 12\text{V}$  or 132W for  $600\mu\text{s}$ . The Si7336ADP datasheet's Transient Thermal Impedance plot indicates that the worse-case increase in junction temperature during the short-circuit condition is  $13.2^\circ\text{C}$  using  $Z_{\text{thJC}} = 0.1^\circ\text{C/W}$  (single pulse). This will not cause the maximum junction temperature to be exceeded. The SOA curves of the Si7336ADP are also checked to be safe under this condition.







## PACKAGE DESCRIPTION

### GN Package 16-Lead Plastic SSOP (Narrow .150 Inch) (Reference LTC DWG # 05-08-1641)

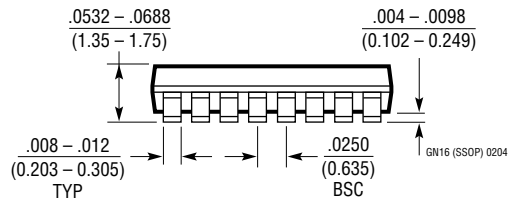
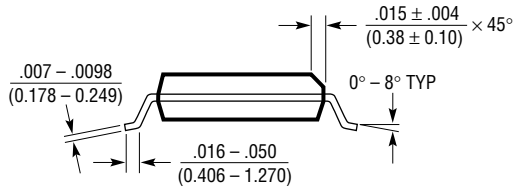
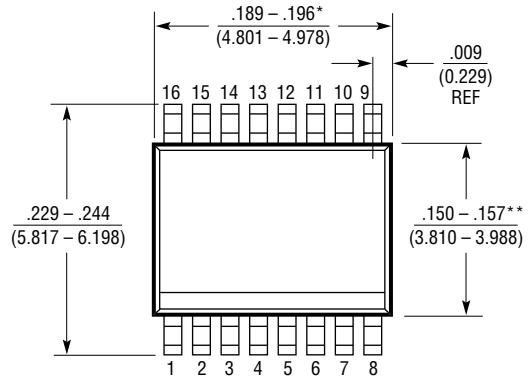
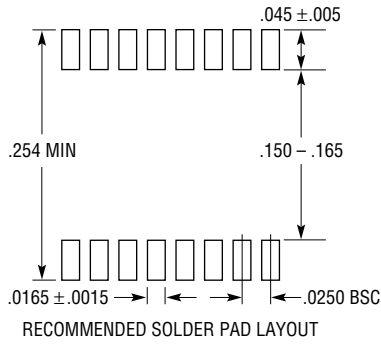

**NOTE:**

1. CONTROLLING DIMENSION: INCHES
2. DIMENSIONS ARE IN  $\frac{\text{INCHES}}{\text{MILLIMETERS}}$

3. DRAWING NOT TO SCALE

\*DIMENSION DOES NOT INCLUDE MOLD FLASH. MOLD FLASH SHALL NOT EXCEED 0.006" (0.152mm) PER SIDE

\*\*DIMENSION DOES NOT INCLUDE INTERLEAD FLASH. INTERLEAD FLASH SHALL NOT EXCEED 0.010" (0.254mm) PER SIDE

# PACKAGE DESCRIPTION

**DHD Package**  
**16-Lead Plastic DFN (5mm × 4mm)**  
 (Reference LTC DWG # 05-08-1707)

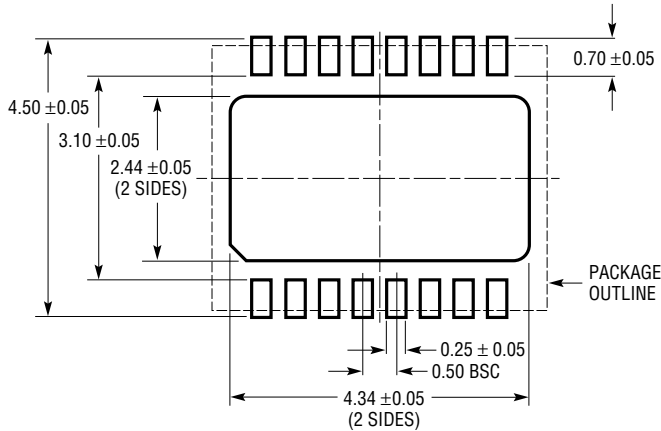

**RECOMMENDED SOLDER PAD PITCH AND DIMENSIONS**

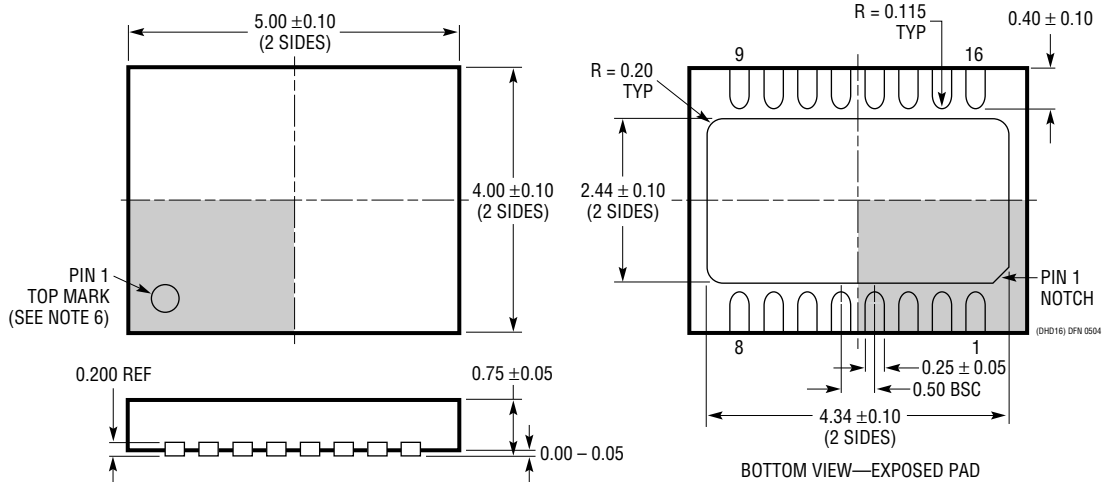

**NOTE:**

1. DRAWING PROPOSED TO BE MADE VARIATION OF VERSION (WJGD-2) IN JEDEC PACKAGE OUTLINE MO-229
2. DRAWING NOT TO SCALE
3. ALL DIMENSIONS ARE IN MILLIMETERS
4. DIMENSIONS OF EXPOSED PAD ON BOTTOM OF PACKAGE DO NOT INCLUDE MOLD FLASH. MOLD FLASH, IF PRESENT, SHALL NOT EXCEED 0.15mm ON ANY SIDE
5. EXPOSED PAD SHALL BE SOLDER PLATED
6. SHADED AREA IS ONLY A REFERENCE FOR PIN 1 LOCATION ON THE TOP AND BOTTOM OF PACKAGE

