



Chipsmall Limited consists of a professional team with an average of over 10 year of expertise in the distribution of electronic components. Based in Hongkong, we have already established firm and mutual-benefit business relationships with customers from,Europe,America and south Asia,supplying obsolete and hard-to-find components to meet their specific needs.

With the principle of “Quality Parts,Customers Priority,Honest Operation,and Considerate Service”,our business mainly focus on the distribution of electronic components. Line cards we deal with include Microchip,ALPS,ROHM,Xilinx,Pulse,ON,Everlight and Freescale. Main products comprise IC,Modules,Potentiometer,IC Socket,Relay,Connector.Our parts cover such applications as commercial,industrial, and automotives areas.

We are looking forward to setting up business relationship with you and hope to provide you with the best service and solution. Let us make a better world for our industry!



Contact us

Tel: +86-755-8981 8866 Fax: +86-755-8427 6832

Email & Skype: info@chipsmall.com Web: www.chipsmall.com

Address: A1208, Overseas Decoration Building, #122 Zhenhua RD., Futian, Shenzhen, China



FEATURES

- Very Low Power: $I_{CC} = 110\mu\text{A Typ}$
- Designed for RS485 or RS422 Applications
- Single 5V Supply
- -7V to 12V Bus Common-Mode Range Permits $\pm 7\text{V}$ GND Difference Between Devices on the Bus
- Thermal Shutdown Protection
- Power-Up/Down Glitch-Free Driver Outputs Permit Live Insertion/Removal of Package
- Driver Maintains High Impedance in Three-State or with the Power Off
- 28ns Typical Driver Propagation Delays with 5ns Skew
- Pin Compatible with the SN75172, DS96172, μA96172 , and DS96F172

APPLICATIONS

- Low Power RS485/RS422 Drivers
- Level Translator

DESCRIPTION

The LTC[®]486 is a low power differential bus/line driver designed for multipoint data transmission standard RS485 applications with extended common-mode range (12V to -7V). It also meets RS422 requirements.

The CMOS design offers significant power savings over its bipolar counterpart without sacrificing ruggedness against overload or ESD damage.

The driver features three-state outputs, with the driver outputs maintaining high impedance over the entire common-mode range. Excessive power dissipation caused by bus contention or faults is prevented by a thermal shutdown circuit which forces the driver outputs into a high impedance state.

Both AC and DC specifications are guaranteed from 0°C to 70°C (Commercial), -40°C to 85°C (Industrial), over the 4.75V to 5.25V supply voltage range.

LT, LT, LTC, LTM, Linear Technology, μModule and the Linear logo are registered trademarks of Linear Technology Corporation. All other trademarks are the property of their respective owners.

TYPICAL APPLICATION

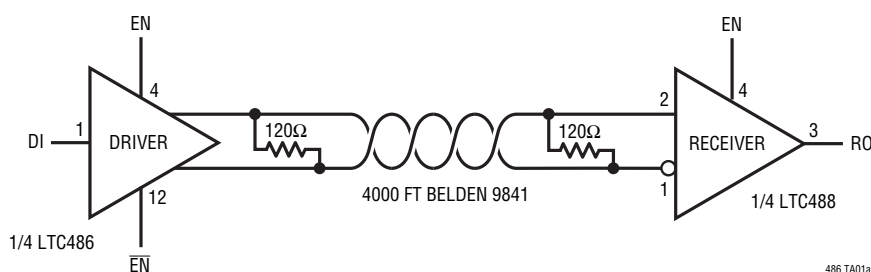

RS485 Length Specification

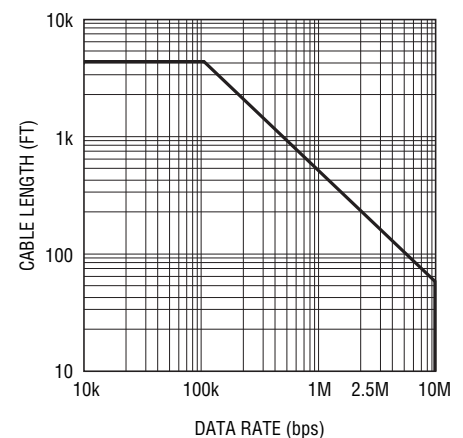

* APPLIES FOR 24 GAUGE, POLYETHYLENE DIELECTRIC TWISTED PAIR

LTC486

ABSOLUTE MAXIMUM RATINGS

(Note 1)

Supply Voltage (V_{CC})	12V
Control Input Voltages	0.5V to $V_{CC} + 0.5V$
Driver Input Voltages	-0.5V to $V_{CC} + 0.5V$
Driver Output Voltages	$\pm 14V$
Control Input Currents	$\pm 25mA$
Driver Input Currents	$\pm 25mA$
Operating Temperature Range	
LTC486C	0°C to 70°C
LTC486I	-40°C to 85°C
Storage Temperature Range	-65°C to 150°C
Lead Temperature (Soldering, 10 sec)	300°C

PIN CONFIGURATION

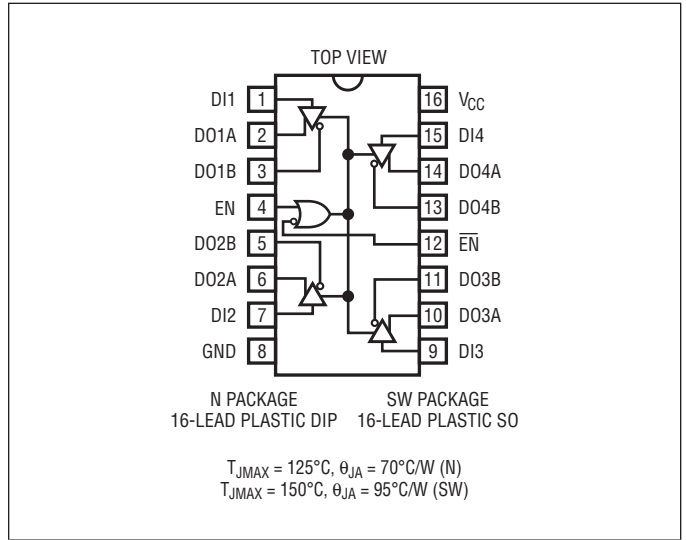

Consult factory for Military grade parts.

ORDER INFORMATION

LEAD FREE FINISH	TAPE AND REEL	PART MARKING	PACKAGE DESCRIPTION	TEMPERATURE RANGE
LTC486CN#PBF	LTC486CN#TRPBF	LTC486CN	16-Lead Plastic DIP	0°C to 70°C
LTC486CSW#PBF	LTC486CSW#TRPBF	LTC486CSW	16-Lead Plastic SO	0°C to 70°C
LTC486IN#PBF	LTC486IN#TRPBF	LTC486IN	16-Lead Plastic DIP	-40°C to 85°C
LTC486ISW#PBF	LTC486ISW#TRPBF	LTC486ISW	16-Lead Plastic SO	-40°C to 85°C

Consult LTC Marketing for parts specified with wider operating temperature ranges.

For more information on lead free part marking, go to: <http://www.linear.com/leadfree/>

For more information on tape and reel specifications, go to: <http://www.linear.com/tapeandreel/>

DC ELECTRICAL CHARACTERISTICS

$V_{CC} = 5V \pm 5\%$, $0^{\circ}C \leq \text{Temperature} \leq 70^{\circ}C$ (Commercial), $-40^{\circ}C \leq \text{Temperature} \leq 85^{\circ}C$ (Industrial) (Notes 2, 3)

SYMBOL	PARAMETER	CONDITIONS	MIN	TYP	MAX	UNITS
V_{OD1}	Differential Driver Output Voltage (Unloaded)	$I_{OUT} = 0$			5	V
V_{OD2}	Differential Driver Output Voltage (With Load)	$R = 50\Omega$; (RS422)	2			V
		$R = 27\Omega$; (RS485) (Figure 1)	1.5		5	V
V_{OD}	Change in Magnitude of Driver Differential Output Voltage for Complementary Output States	$R = 27\Omega$ or $R = 50\Omega$ (Figure 1)			0.2	V
V_{OC}	Driver Common-Mode Output Voltage				3	V
$ V_{OC} $	Change in Magnitude of Driver Common-Mode Output Voltage for Complementary Output States				0.2	V
V_{IH}	Input High Voltage	DI, EN, \bar{EN}	2.0			V
V_{IL}	Input Low Voltage				0.8	V
I_{IN1}	Input Current				± 2	μA
I_{CC}	Supply Current	No Load		110	200	μA
		Output Enabled Output Disabled		110	200	μA
I_{OSD1}	Driver Short-Circuit Current, $V_{OUT} = \text{High}$	$V_{OUT} = -7V$		100	250	mA
I_{OSD2}	Driver Short-Circuit Current, $V_{OUT} = \text{Low}$	$V_{OUT} = 12V$		100	250	mA
I_{OZ}	High Impedance State Output Current	$V_{OUT} = -7V$ to $12V$		± 10	± 200	μA

SWITCHING CHARACTERISTICS

$V_{CC} = 5V \pm 5\%$, $0^{\circ}C \leq \text{Temperature} \leq 70^{\circ}C$ (Commercial), $-40^{\circ}C \leq \text{Temperature} \leq 85^{\circ}C$ (Industrial) (Notes 2, 3)

SYMBOL	PARAMETER	CONDITIONS	MIN	TYP	MAX	UNITS	
t_{PLH}	Driver Input to Output	$R_{DIFF} = 54\Omega$, $C_{L1} = C_{L2} = 100pF$ (Figures 2, 4)	10	30	50	ns	
t_{PHL}	Driver Input to Output		10	30	50	ns	
t_{SKEW}	Driver Output to Output				5	15	ns
t_r, t_f	Driver Rise or Fall Time			5	15	25	ns
t_{ZH}	Driver Enable to Output High	$C_L = 100pF$ (Figures 3, 5) S2 Closed		35	70	ns	
t_{ZL}	Driver Enable to Output Low	$C_L = 100pF$ (Figures 3, 5) S1 Closed		35	70	ns	
t_{LZ}	Driver Disable Time from Low	$C_L = 15pF$ (Figures 3, 5) S1 Closed		35	70	ns	
t_{HZ}	Driver Disable Time from High	$C_L = 15pF$ (Figures 3, 5) S2 Closed		35	70	ns	

Note 1: Stresses beyond those listed under Absolute Maximum Ratings may cause permanent damage to the device. Exposure to any Absolute Maximum Rating condition for extended periods may affect device reliability and lifetime.

Note 2: All currents into device pins are positive; all currents out of device pins are negative. All voltages are referenced to device ground unless otherwise specified.

Note 3: All typicals are given for $V_{CC} = 5V$ and temperature = $25^{\circ}C$.

SWITCHING TIME WAVEFORMS

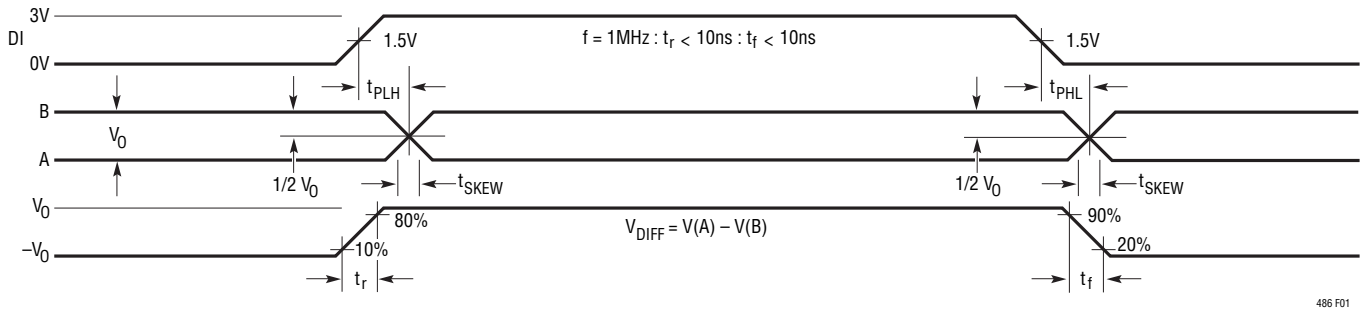

486 F01

Figure 1. Driver Propagation Delays

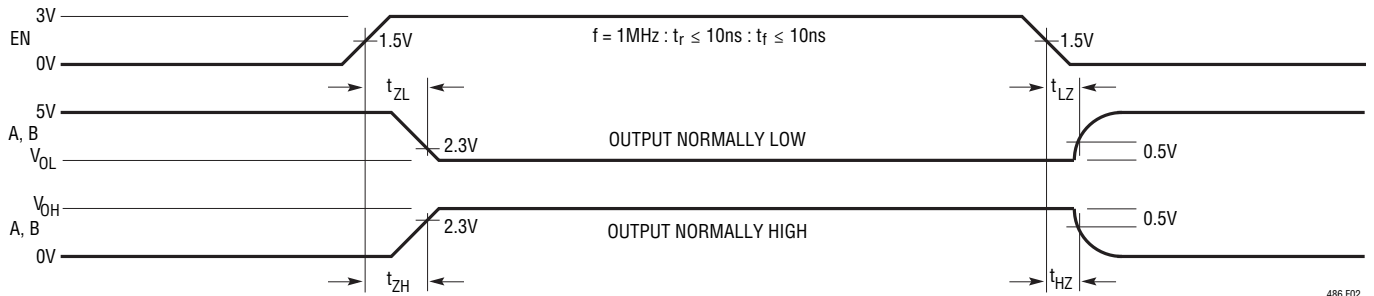

486 F02

Figure 2. Driver Enable and Disable Times

TYPICAL PERFORMANCE CHARACTERISTICS

Driver Output High Voltage vs Output Current $T_A = 25^\circ\text{C}$

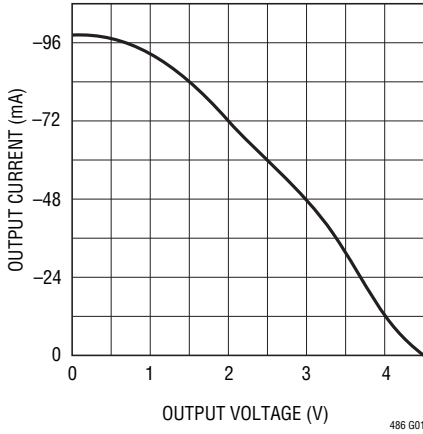

Driver Differential Output Voltage vs Output Current $T_A = 25^\circ\text{C}$

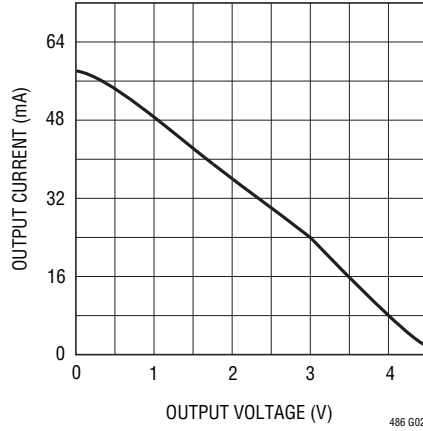

Driver Output Low Voltage vs Output Current $T_A = 25^\circ\text{C}$

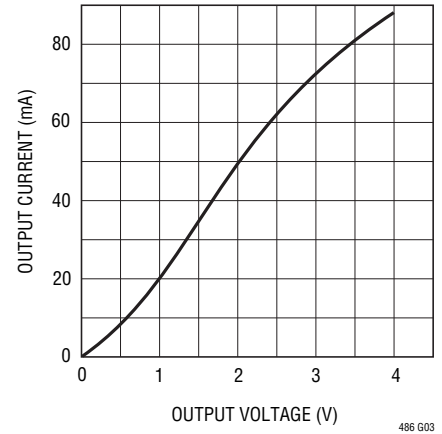

TTL Input Threshold vs Temperature

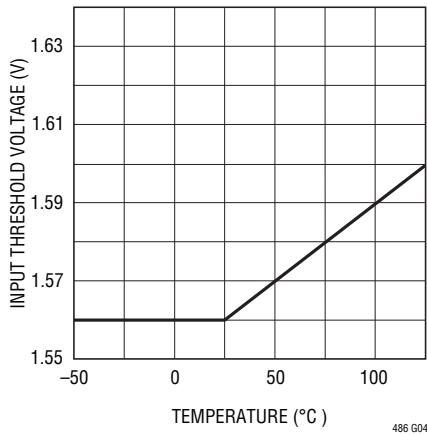

Driver Skew vs Temperature

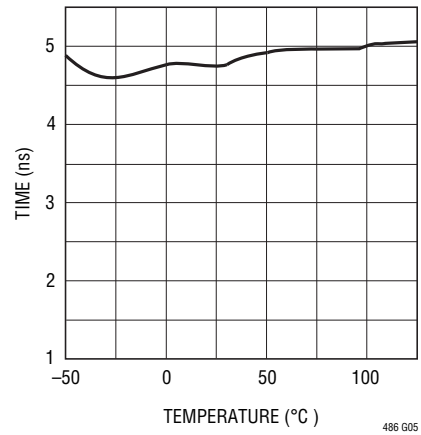

Supply Current vs Temperature

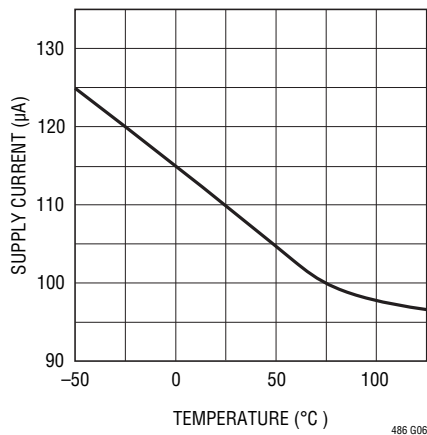

Driver Differential Output Voltage vs Temperature $R_0 = 54\Omega$

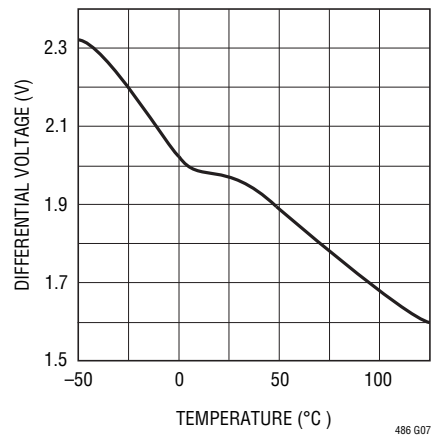

FUNCTION TABLE

INPUT	ENABLES		OUTPUTS	
	EN	$\overline{\text{EN}}$	OUTA	OUTB
H	H	X	H	L
L	H	X	L	H
H	X	L	H	L
L	X	L	L	H
X	L	H	Z	Z

H: High Level
 L: Low Level
 X: Irrelevant
 Z: High Impedance (Off)

PIN FUNCTIONS

DI1 (Pin 1): Driver 1 Input. If Driver 1 is enabled, then a low on DI1 forces the driver outputs DO1A low and DO1B high. A high on DI1 with the driver outputs enabled will force DO1A high and DO1B low.

DO1A (Pin 2): Driver 1 Output.

DO1B (Pin 3): Driver 1 Output.

EN (Pin 4): Driver Outputs Enabled. See Function Table for details.

DO2B (Pin 5): Driver 2 Output.

DO2A (Pin 6): Driver 2 Output.

DI2 (Pin 7): Driver 2 Input. Refer to DI1

GND (Pin 8): Ground Connection.

DI3 (Pin 9): Driver 3 Input. Refer to DI1.

DO3A (Pin 10): Driver 3 Output.

DO3B (Pin 11): Driver 3 Output.

$\overline{\text{EN}}$ (Pin 12): Driver Outputs Disabled. See Function Table for details.

DO4B (Pin 13): Driver 4 Output.

DO4A (Pin 14): Driver 4 Output.

DI4 (Pin 15): Driver 4 Input. Refer to DI1.

V_{CC} (Pin 16): Positive Supply; $4.75\text{V} < V_{\text{CC}} < 5.25\text{V}$

TEST CIRCUITS

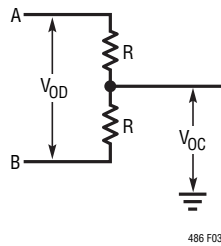

Figure 3. Driver DC Test Load

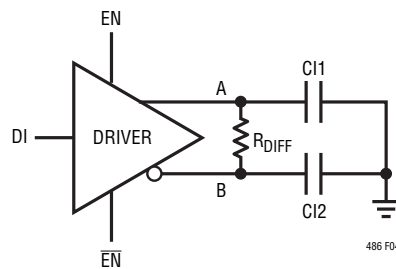

Figure 4. Driver Timing Test Circuit

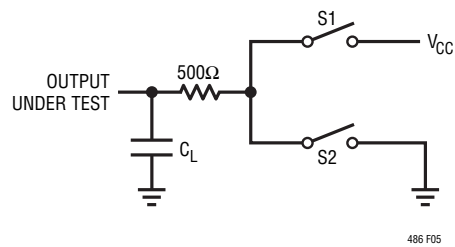

Figure 5. Driver Timing Test Load #2

APPLICATIONS INFORMATION

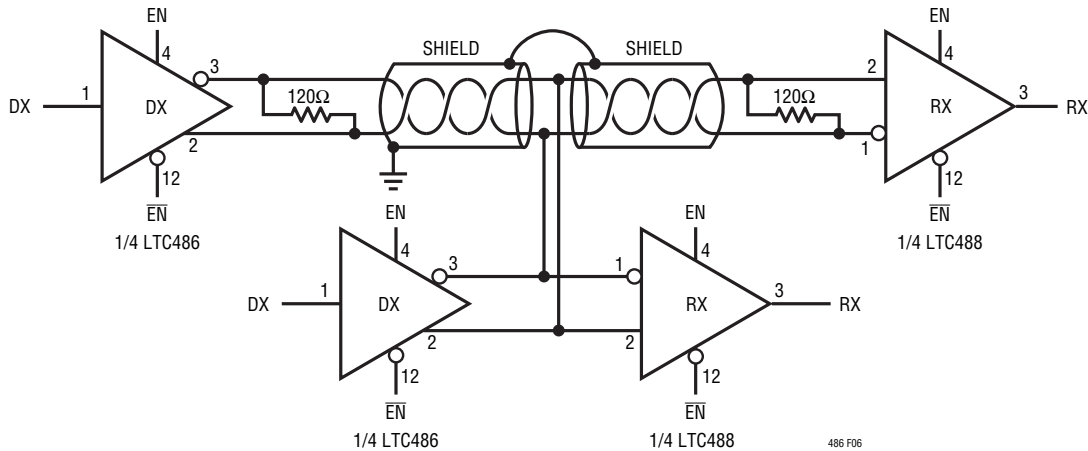

Figure 6. Typical Connection

Typical Application

A typical connection of the LTC486 is shown in Figure 6. A twisted pair of wires connect up to 32 drivers and receivers for half duplex data transmission. There are no restrictions on where the chips are connected to the wires, and it isn't necessary to have the chips connected at the ends. However, the wires must be terminated only at the ends with a resistor equal to their characteristic impedance, typically 120Ω. The optional shields around the twisted pair help reduce unwanted noise, and are connected to GND at one end.

Thermal Shutdown

The LTC486 has a thermal shutdown feature which protects the part from excessive power dissipation. If the outputs of the driver are accidentally shorted to a power supply or low impedance source, up to 250mA can flow through the part. The thermal shutdown circuit disables the driver outputs when the internal temperature reaches 150°C and turns them back on when the temperature cools to 130°C. If the outputs of two or more LTC486 drivers are shorted directly, the driver outputs cannot supply enough current to activate the thermal shutdown. Thus, the thermal shutdown circuit will not prevent contention faults when two drivers are active on the bus at the same time.

Cable and Data Rate

The transmission line of choice for RS485 applications is a twisted pair. There are coaxial cables (twinaxial) made for this purpose that contain straight pairs, but these are less flexible, more bulky, and more costly than twisted pairs. Many cable manufacturers offer a broad range of 120Ω cables designed for RS485 applications.

Losses in a transmission line are a complex combination of DC conductor loss, AC losses (skin effect), leakage, and AC losses in the dielectric. In good polyethylene cables such as the Belden 9841, the conductor losses and dielectric losses are of the same order of magnitude, with relatively low overall loss (Figure 7).

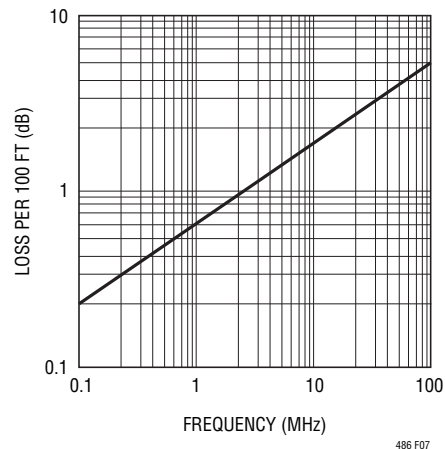

Figure 7. Attenuation vs Frequency for Belden 9841

APPLICATIONS INFORMATION

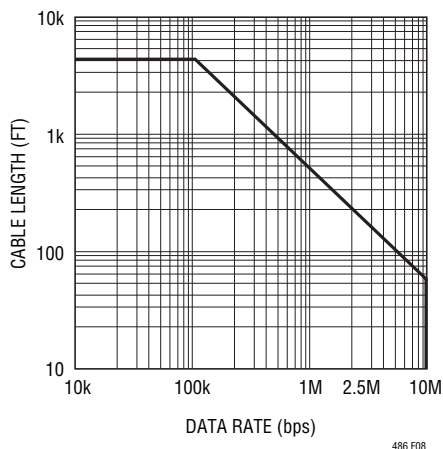

Figure 8. Cable Length vs Data Rate

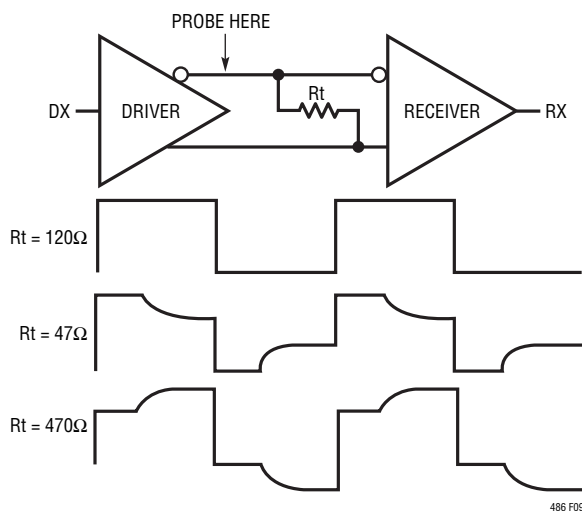

Figure 9. Termination Effects

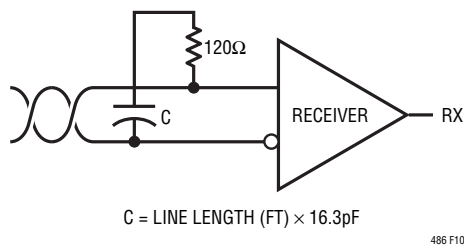

Figure 10. AC Coupled Termination

When using low loss cables, Figure 8 can be used as a guideline for choosing the maximum line length for a given data rate. With lower quality PVC cables, the dielectric loss factor can be 1000 times worse. PVC twisted pairs have terrible losses at high data rates (>100kbs) and greatly reduce the maximum cable length. At low data rates however, they are acceptable and much more economical.

Cable Termination

The proper termination of the cable is very important. If the cable is not terminated with its characteristic impedance, distorted waveforms will result. In severe cases, distorted (false) data and nulls will occur. A quick look at the output of the driver will tell how well the cable is terminated. It is best to look at a driver connected to the end of the cable, since this eliminates the possibility of getting reflections from two directions. Simply look at the driver output while transmitting square wave data. If the cable is terminated properly, the waveform will look like a square wave (Figure 9).

If the cable is loaded excessively (e.g., 47Ω), the signal initially sees the surge impedance of the cable and jumps to an initial amplitude. The signal travels down the cable and is reflected back out of phase because of the mismatch. When the reflected signal returns to the driver, the amplitude will be lowered. The width of the pedestal is equal to twice the electrical length of the cable (about 1.5ns/ft). If the cable is lightly loaded (e.g., 470Ω), the signal reflects in phase and increases the amplitude at the driver output. An input frequency of 30kHz is adequate for tests out to 4000 ft. of cable.

AC Cable Termination

Cable termination resistors are necessary to prevent unwanted reflections, but they consume power. The typical differential output voltage of the driver is 2V when the cable is terminated with two 120Ω resistors. When no data is being sent 33mA of DC current flows in the cable. This DC current is about 220 times greater than the supply current of the LTC486. One way to eliminate the unwanted current is by AC coupling the termination resistors as shown in Figure 10.

APPLICATIONS INFORMATION

The coupling capacitor allows high frequency energy to flow to the termination, but blocks DC and low frequencies. The dividing line between high and low frequency depends on the length of the cable. The coupling capacitor must pass frequencies above the point where the line represents an electrical one-tenth wavelength. The value of the coupling capacitor should therefore be set at 16.3pF per foot of cable length for 120Ω cables. With the coupling capacitors in place, power is consumed only on the signal edges, not when the driver output is idling at a 1 or 0 state. A 100nF capacitor is adequate for lines up to 4000 feet in length. Be aware that the power savings start to decrease once the data rate surpasses $1/(120\Omega \times C)$.

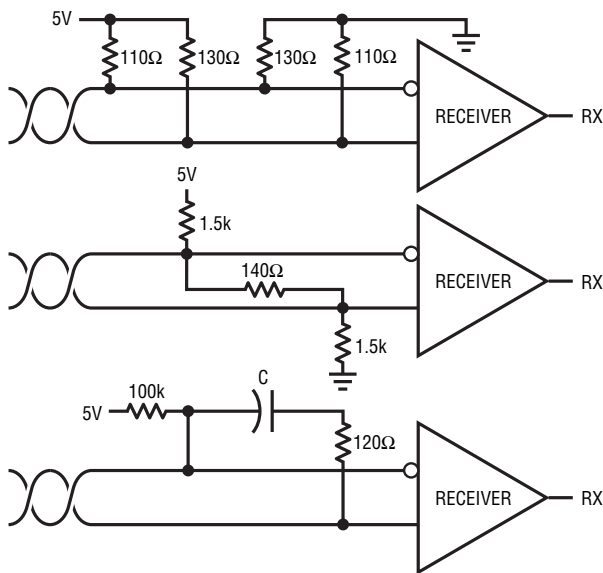

Figure 11. Forcing “0” When All Drivers Are Off

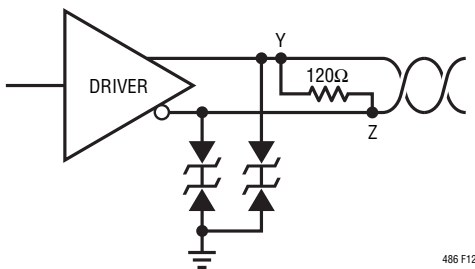

Figure 12. ESD Protection

Receiver Open-Circuit Fail-Safe

Some data encoding schemes require that the output of the receiver maintains a known state (usually a logic 1) when the data is finished transmitting and all drivers on the line are forced into three-state. All LTC RS485 receivers have a fail-safe feature which guarantees the output to be in a logic 1 state when the receiver inputs are left floating (open-circuit). However, when the cable is terminated with 120Ω, the differential inputs to the receiver are shorted together, not left floating.

If the receiver output must be forced to a known state, the circuits of Figure 11 can be used.

The termination resistors are used to generate a DC bias which forces the receiver output to a known state, in this case a logic 0. The first method consumes about 208mW and the second about 8mW. The lowest power solution is to use an AC termination with a pull-up resistor. Simply swap the receiver inputs for data protocols ending in logic 1.

Fault Protection

All of LTC's RS485 products are protected against ESD transients up to ±2kV using the human body model (100pF, 1.5kΩ). However, some applications need greater protection. The best protection method is to connect a bidirectional TransZorb from each line side pin to ground (Figure 12).

A TransZorb is a silicon transient voltage suppressor that has exceptional surge handling capabilities, fast response time, and low series resistance. They are available from General Semiconductor Industries and come in a variety of breakdown voltages and prices. Be sure to pick a breakdown voltage higher than the common-mode voltage required for your application (typically 12V). Also, don't forget to check how much the added parasitic capacitance will load down the bus.

PACKAGE DESCRIPTION

Please refer to <http://www.linear.com/designtools/packaging/> for the most recent package drawings.

N Package 16-Lead PDIP (Narrow .300 Inch) (Reference LTC DWG # 05-08-1510 Rev I)

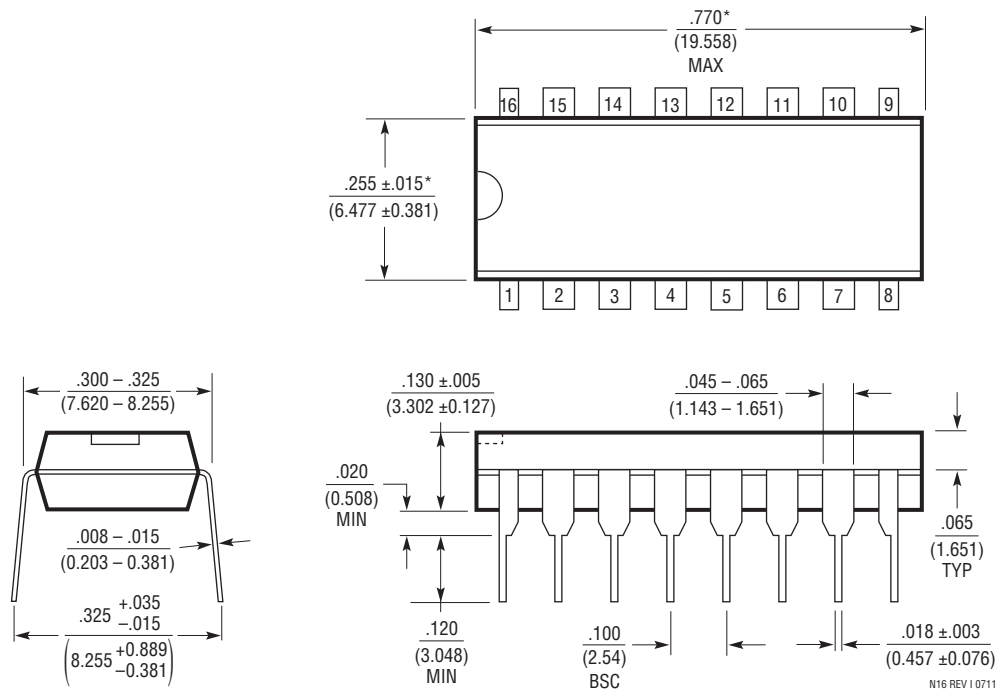

N16 REV I 0711

PACKAGE DESCRIPTION

Please refer to <http://www.linear.com/designtools/packaging/> for the most recent package drawings.

SW Package 16-Lead Plastic Small Outline (Wide .300 Inch) (Reference LTC DWG # 05-08-1620)

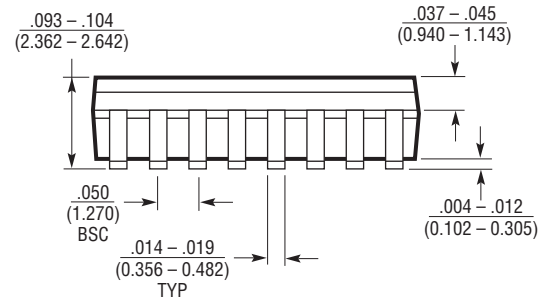
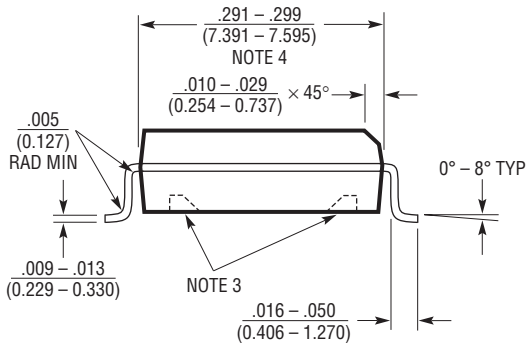
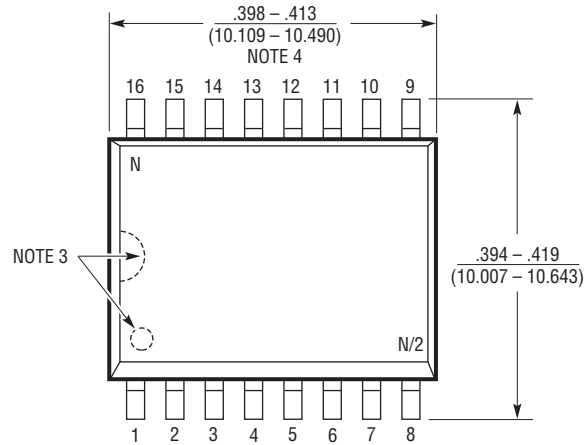
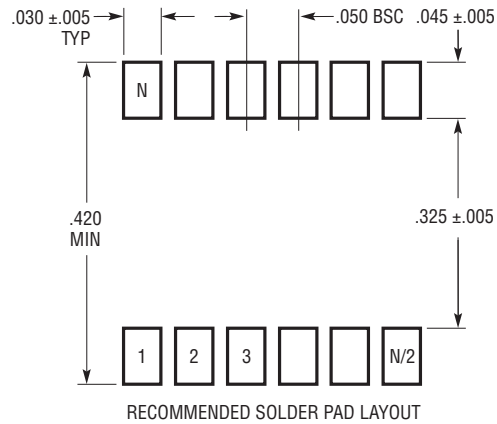

- NOTE:
1. DIMENSIONS IN $\frac{\text{INCHES}}{\text{MILLIMETERS}}$
 2. DRAWING NOT TO SCALE
 3. PIN 1 IDENT, NOTCH ON TOP AND CAVITIES ON THE BOTTOM OF PACKAGES ARE THE MANUFACTURING OPTIONS. THE PART MAY BE SUPPLIED WITH OR WITHOUT ANY OF THE OPTIONS
 4. THESE DIMENSIONS DO NOT INCLUDE MOLD FLASH OR PROTRUSIONS. MOLD FLASH OR PROTRUSIONS SHALL NOT EXCEED .006" (0.15mm)

S16 (WIDE) 0502

REVISION HISTORY (Revision history begins at Rev C)

REV	DATE	DESCRIPTION	PAGE NUMBER
C	11/12	Order Information: corrected Package Descriptions Added Related Parts section	2 14

TYPICAL APPLICATION

RS232 to RS485 Level Translator with Hysteresis

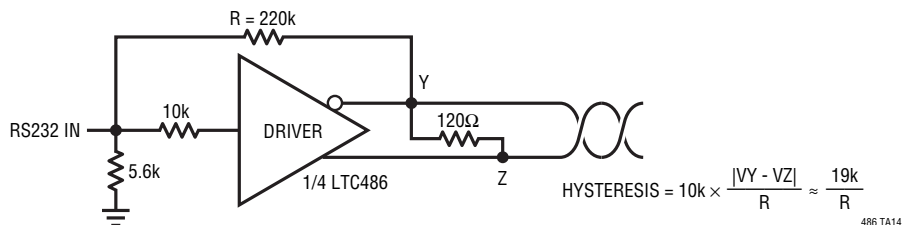

RELATED PARTS

PART NUMBER	DESCRIPTION	COMMENTS
RS485 Quad Drivers		
LTC487	Low Power RS485 Quad Drivers	10Mbps, ±4kV ESD, Two DE Pins, SO(W)-16 or DIP-16 Package
LTC1688/LTC1689	High Speed RS485 Quad Drivers	100Mbps, ±4kV ESD, One-Half DE Pins, SO-16 Package
RS485 Quad Receivers		
LTC1518/LTC1519	High Speed RS485 Quad Receivers	52Mbps, ±4kV ESD, SO-16 Package
LTC1520	Precision RS485 Quad Receivers	50Mbps, 18ns Propagation Delay, SO-16 Package
LTC488/LTC489	Low Power RS485 Quad Receivers	10Mbps, ±10kV ESD, One-Half DE Pins, SO(W)-16 or DIP-16 Package
Fault Protected 3V to 5.5V RS485 Transceivers		
LTC2862	±60V Fault Protected RS485 Transceiver	Half Duplex, 20Mbps or 250kbps, ±25kV Common Mode Range, ±15kV, Enable Pins, SO-8 or 3mm × 3mm DFN-8 Package
LTC2863	±60V Fault Protected RS485 Transceiver	Full Duplex, 20Mbps or 250kbps, ±25kV Common Mode Range, ±15kV, SO-8 or 3mm × 3mm DFN-8 Package
LTC2864	±60V Fault Protected RS485 Transceiver	Full Duplex, 20Mbps or 250kbps, ±25kV Common Mode Range, ±15kV, Enable Pins, SO-14 or 3mm × 3mm DFN-10 Package
LTC2865	±60V Fault Protected RS485 Transceiver	Full Duplex, Selectable 20Mbps or 250kbps, ±25kV Common Mode Range, ±15kV, Enable Pins, Logic Supply, MSOP-12 or 4mm × 3mm DFN-12
Isolated RS485 Transceivers		
LTM2881	Complete Isolated RS485 μModule [®] Transceiver + Power	±2500V _{RMS} Isolation, 3.3V or 5V Supply, No External Components, 1W DC/DC Converter, Switchable Termination, 20Mbps, 30kV/μs Common Mode, ±15kV ESD, 15mm × 11.25mm LGA or BGA Package
LTC1535	Isolated RS485 Transceiver	5V Supply, 250kbps, ±8kV ESD, SO(W)-28