



Chipsmall Limited consists of a professional team with an average of over 10 year of expertise in the distribution of electronic components. Based in Hongkong, we have already established firm and mutual-benefit business relationships with customers from,Europe,America and south Asia,supplying obsolete and hard-to-find components to meet their specific needs.

With the principle of “Quality Parts,Customers Priority,Honest Operation,and Considerate Service”,our business mainly focus on the distribution of electronic components. Line cards we deal with include Microchip,ALPS,ROHM,Xilinx,Pulse,ON,Everlight and Freescale. Main products comprise IC,Modules,Potentiometer,IC Socket,Relay,Connector.Our parts cover such applications as commercial,industrial, and automotives areas.

We are looking forward to setting up business relationship with you and hope to provide you with the best service and solution. Let us make a better world for our industry!



Contact us

Tel: +86-755-8981 8866 Fax: +86-755-8427 6832

Email & Skype: info@chipsmall.com Web: www.chipsmall.com

Address: A1208, Overseas Decoration Building, #122 Zhenhua RD., Futian, Shenzhen, China



300MHz to 3GHz RF Power Detector in SC70 Package

FEATURES

- Temperature Compensated Internal Schottky Diode RF Detector
- Wide Input Frequency Range: 300MHz to 3GHz
- Wide Input Power Range: -30dBm to 6dBm
- Buffered Detector Output
- Wide V_{CC} Range of 2.7V to 6V
- Low Operating Current: 600 μ A
- Low Shutdown Current: <2 μ A
- SC70 Package

APPLICATIONS

- Multimode Mobile Phone Products
- Optical Data Links
- Wireless Data Modems
- Wireless and Cable Infrastructure
- RF Power Alarm
- Envelope Detector

DESCRIPTION

The LTC[®]5509 is an RF power detector for RF applications operating in the 300MHz to 3GHz range. A temperature compensated Schottky diode peak detector and buffer amplifier are combined in a small SC70 package. The supply voltage range is optimized for operation from a single lithium-ion cell or 3xNiMH.

The RF input voltage is peak detected using an on-chip Schottky diode. The detected voltage is buffered and supplied to the V_{OUT} pin without gain compression. Consequently, the output voltage is linearly proportional to the RF input voltage. A power saving shutdown mode reduces supply current to less than 2 μ A.

The LTC5509 operates with input power levels from -30dBm to 6dBm.

LTC, LTC and LT are registered trademarks of Linear Technology Corporation.

TYPICAL APPLICATION

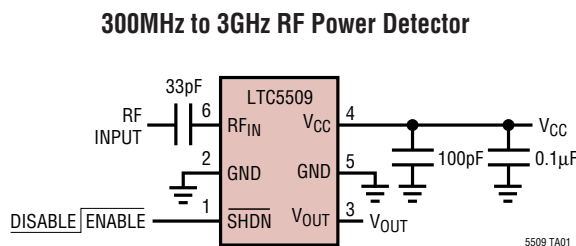

Output Voltage vs RF Input Power

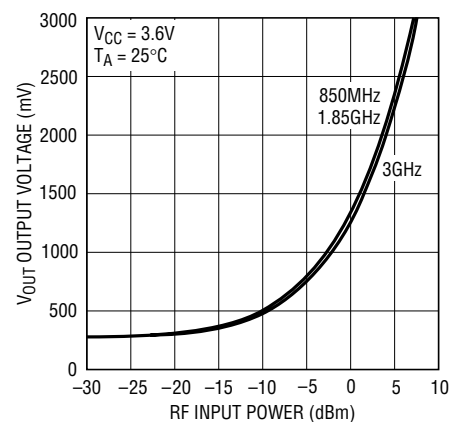

5509 TA02

ABSOLUTE MAXIMUM RATINGS

(Note 1)

V_{CC} , V_{OUT} to GND	-0.3V to 6.5V
R_{FIN} Voltage	($V_{CC} \pm 1V$) to 7V
SHDN Voltage to GND	-0.3V to ($V_{CC} + 0.3V$)
I_{VOUT}	5mA
Operating Temperature Range (Note 2) ..	-40°C to 85°C
Maximum Junction Temperature	125°C
Storage Temperature Range	-65°C to 150°C
Lead Temperature (Soldering, 10 sec).....	300°C

PACKAGE/ORDER INFORMATION

	ORDER PART NUMBER
	LTC5509ESC6
	SC6 PART MARKING
	LADD

Consult LTC Marketing for parts specified with wider operating temperature ranges.

ELECTRICAL CHARACTERISTICS

The ● denotes the specifications which apply over the full operating temperature range, otherwise specifications are at $T_A = 25^\circ\text{C}$. $V_{CC} = 3.6V$, $\overline{\text{SHDN}} = V_{CC} = \text{HI}$, $\overline{\text{SHDN}} = 0V = \text{LO}$, RF Input Signal is Off, unless otherwise noted.

PARAMETER	CONDITIONS	MIN	TYP	MAX	UNITS
V_{CC} Operating Voltage		●	2.7	6	V
I_{VCC} Shutdown Current	$\overline{\text{SHDN}} = \text{LO}$	●		2	μA
I_{VCC} Operating Current	$\overline{\text{SHDN}} = \text{HI}$, $I_{VOUT} = 0\text{mA}$	●	0.58	0.85	mA
V_{OUT} V_{OL} (No RF Input)	$R_{LOAD} = 2k$, $\overline{\text{SHDN}} = \text{HI}$, Enabled $\overline{\text{SHDN}} = \text{LOW}$, Disabled		150 250 1	400	mV mV
V_{OUT} Output Current	$V_{OUT} = 1.75V$, $V_{CC} = 2.7V$, $\Delta V_{OUT} = 10\text{mV}$	●	1	2	mA
V_{OUT} Enable Time	$\overline{\text{SHDN}} = \text{HI}$, $C_{LOAD} = 33\text{pF}$, $R_{LOAD} = 2k$	●		8	μs
V_{OUT} Bandwidth	$C_{LOAD} = 33\text{pF}$, $R_{LOAD} = 2k$ (Note 4)		1.5		MHz
V_{OUT} Load Capacitance	(Note 6)	●		33	pF
V_{OUT} Slew Rate	$V_{RFIN} = 0.7V$ Step, $C_{LOAD} = 33\text{pF}$, $R_{LOAD} = 2k$ (Note 3)		8		V/ μs
V_{OUT} Noise	$V_{CC} = 3V$, Noise BW = 1.5MHz, 50 Ω RF Input Termination		2		mV _{p-p}
$\overline{\text{SHDN}}$ Voltage, Chip Disabled	$V_{CC} = 2.7V$ to 6V	●		0.35	V
$\overline{\text{SHDN}}$ Voltage, Chip Enabled	$V_{CC} = 2.7V$ to 6V	●	1.4		V
$\overline{\text{SHDN}}$ Input Current	$\overline{\text{SHDN}} = 3.6V$	●	24	40	μA
R_{FIN} Input Frequency Range			300 to 3000		MHz
R_{FIN} Input Power Range	RF Frequency = 300MHz to 3GHz (Note 5, 6)		-30 to 6		dBm
R_{FIN} AC Input Resistance	F = 300MHz, Pin = -25dBm		150		Ω
R_{FIN} Input Shunt Capacitance	F = 300MHz, Pin = -25dBm		0.9		pF

Note 1: Absolute Maximum Ratings are those values beyond which the life of a device may be impaired.

Note 2: Specifications over the -40°C to 85°C operating temperature range are assured by design, characterization and correlation with statistical process controls.

Note 3: The rise time at V_{OUT} is measured between $V_{OUT}/2 + 0.5V$ to $V_{OUT}/2 - 0.5V$.

Note 4: Bandwidth is calculated using the 10% to 90% rise time equation: BW = 0.35/rise time.

Note 5: RF performance is tested at 1800MHz

Note 6: Guaranteed by design.

TYPICAL PERFORMANCE CHARACTERISTICS

Supply Current vs Supply Voltage

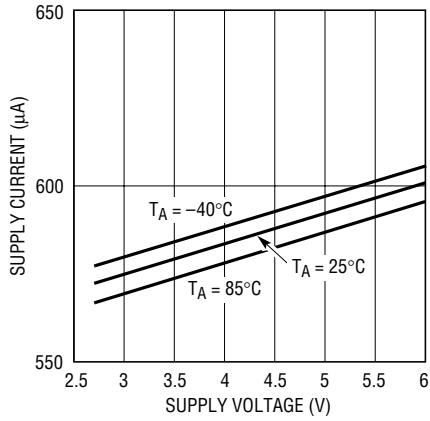

5509 G01

Output Voltage vs Supply Voltage (RF Input Signal Off)

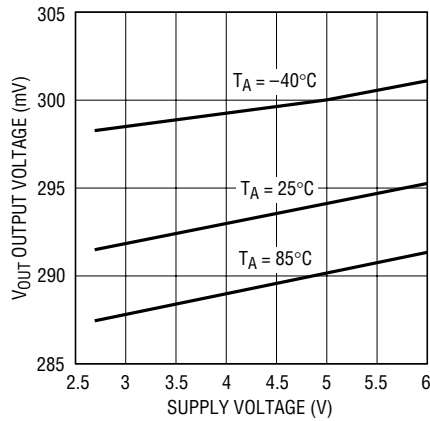

5509 G02

Typical Detector Characteristics, 850MHz

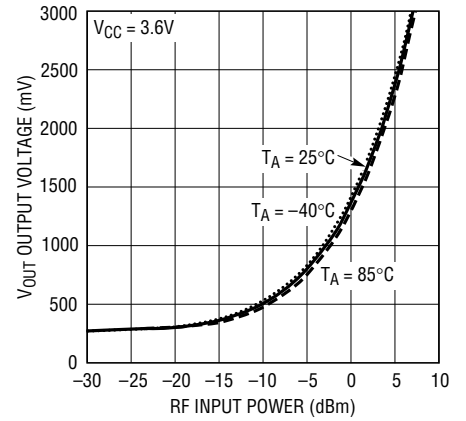

5509 G03

Typical Detector Characteristics, 1850MHz

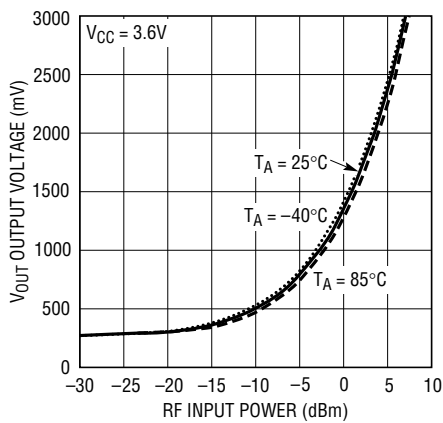

5509 G04

Typical Detector Characteristics, 3000MHz

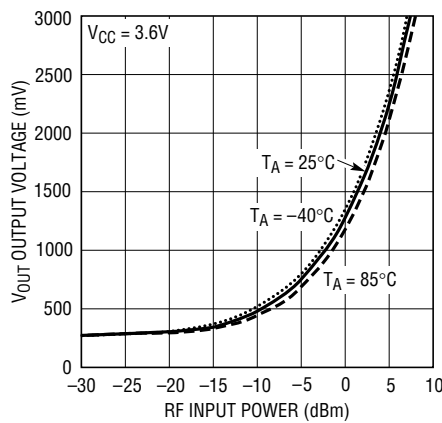

5509 G05

VOUT Slope vs RF Input Power at 850MHz

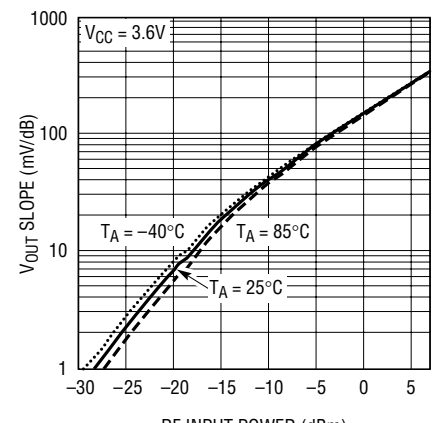

5509 G06

VOUT Slope vs RF Input Power at 1850MHz

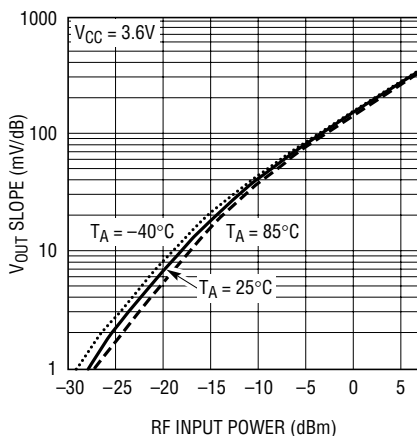

5509 G07

VOUT Slope vs RF Input Power at 3000MHz

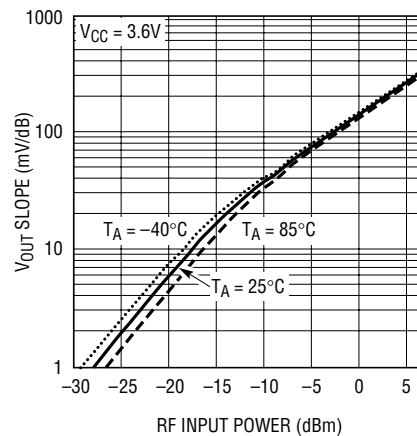

5509 G08

TYPICAL PERFORMANCE CHARACTERISTICS

RF_{IN} Input Impedance (Pin = 0dBm, V_{CC} = 3.6V, T_A = 25°C)

PNT #	FREQUENCY (GHz)	RESISTANCE (Ω)	REACTANCE (Ω)
1	0.300	185.434	-62.632
2	0.468	173.804	-65.491
3	0.637	161.644	-71.893
4	0.806	149.450	-76.830
5	0.975	137.402	-79.300
6	1.143	126.251	-81.429
7	1.312	114.165	-84.108
8	1.481	100.350	-83.547
9	1.650	89.015	-80.053
10	1.818	80.586	-74.762
11	1.987	73.674	-70.242
12	2.156	67.737	-66.323
13	2.325	62.354	-61.497
14	2.493	57.833	-57.213
15	2.662	53.701	-53.443
16	2.831	50.166	-48.992
17	3.000	47.094	-44.997

S11 Forward Reflection Impedance

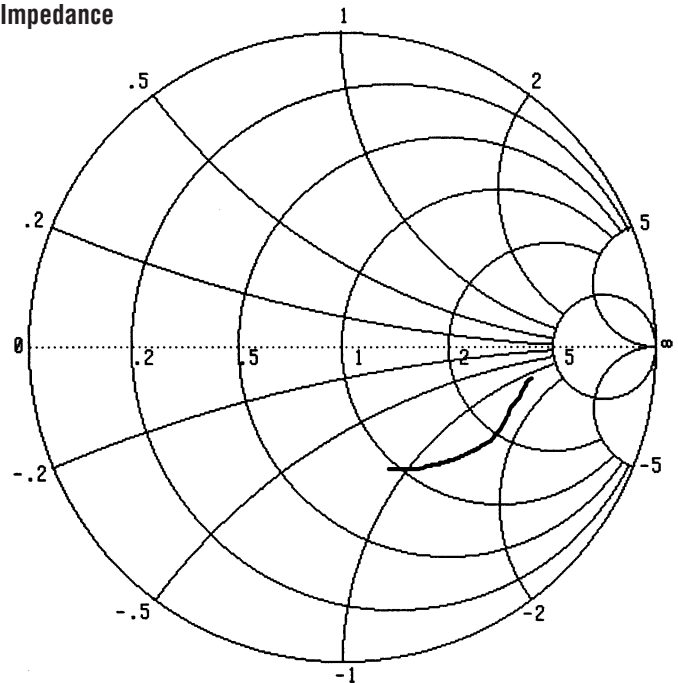

0.300000GHz TO 3.000000GHz

5509 TA03

RF_{IN} Input Impedance (Pin = -25dBm, V_{CC} = 3.6V, T_A = 25°C)

PNT #	FREQUENCY (GHz)	RESISTANCE (Ω)	REACTANCE (Ω)
1	0.300	146.073	-48.091
2	0.468	140.112	-44.500
3	0.637	133.522	-46.654
4	0.806	127.142	-50.559
5	0.975	120.560	-52.094
6	1.143	114.518	-53.472
7	1.312	107.427	-58.362
8	1.481	96.348	-61.184
9	1.650	86.158	-59.226
10	1.818	79.014	-55.746
11	1.987	73.054	-52.613
12	2.156	67.785	-49.515
13	2.325	63.701	-46.430
14	2.493	59.598	-43.378
15	2.662	55.559	-40.355
16	2.831	52.713	-37.150
17	3.000	49.898	-34.268

S11 Forward Reflection Impedance

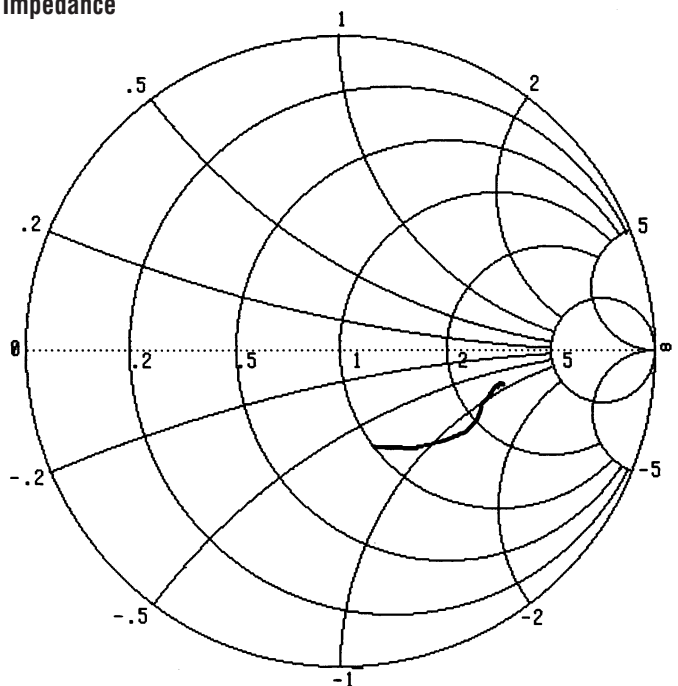

0.300000GHz TO 3.000000GHz

5509 TA04

5509f

PIN FUNCTIONS

SHDN (Pin 1): Shutdown Input. A logic low on the $\overline{\text{SHDN}}$ pin places the part in shutdown mode. A logic high enables the part. SHDN has an internal 150k pull down resistor to ensure that the part is in shutdown when no input is applied.

GND (Pin 2, 5): Ground.

V_{OUT} (Pin 3): Detector Output.

V_{CC} (Pin 4): Power Supply Voltage, 2.7V to 6V. V_{CC} should be bypassed appropriately with ceramic capacitors.

RF_{IN} (Pin 6): RF Input Voltage. Referenced to V_{CC}. A coupling capacitor must be used to connect to the RF signal source. The frequency range is 300MHz to 3GHz. This pin has an internal 250Ω termination, an internal Schottky diode detector and a peak detector capacitor.

BLOCK DIAGRAM

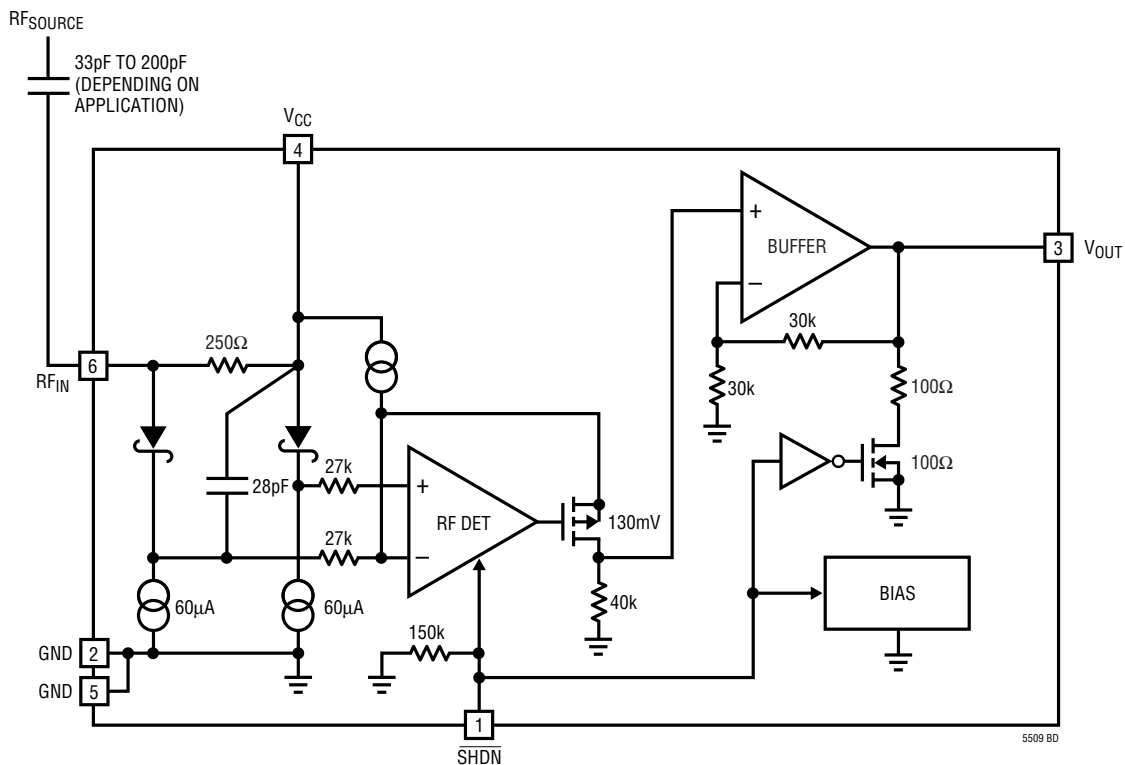

APPLICATIONS INFORMATION

Operation

The LTC5509 RF detector integrates several functions to provide RF power detection over frequencies ranging from 300MHz to 3GHz. These functions include an internally compensated buffer amplifier, an RF Schottky diode peak detector and level shift amplifier to convert the RF feedback signal to DC and a delay circuit to avoid voltage transients at V_{OUT} when coming out of shutdown. The LTC5509 does not incorporate gain compression. Consequently, it offers a linear transfer relationship between RF input voltage and DC output voltage.

Buffer Amplifier

The buffer amplifier is capable of driving a 2mA load. The buffer amplifier typically has an output voltage range of 0.25V to 3V with $V_{CC} = 3.6V$. At lower supply voltages the maximum output swing is reduced.

RF Detector

The internal RF Schottky diode peak detector and level shift amplifier converts the RF input signal to a low frequency signal. The detector demonstrates excellent efficiency and linearity over a wide range of input power.

The Schottky detector is biased at about 60 μ A and drives a peak detector capacitor of 28pF.

Modes of Operation

MODE	\overline{SHDN}	OPERATION
Shutdown	Low	Disabled
Enable	High	Power Detect

Applications

The LTC5509 can be used as a self-standing signal strength measuring receiver for a wide range of input signals from -30dBm to 6dBm for frequencies from 300MHz to 3GHz.

The LTC5509 can be used as a demodulator for AM and ASK modulated signals with data rates up to 1.5MHz. Depending on specific application needs, the RSSI output can be split into two branches, providing AC-coupled data (or audio) output and DC-coupled, RSSI output for signal strength measurements and AGC.

The LTC5509 can be used for RF power detection and control. Refer to Application Note 91, "Low Cost Coupling Methods for RF Power Detectors Replace Directional Couplers."

Demo Board Schematic

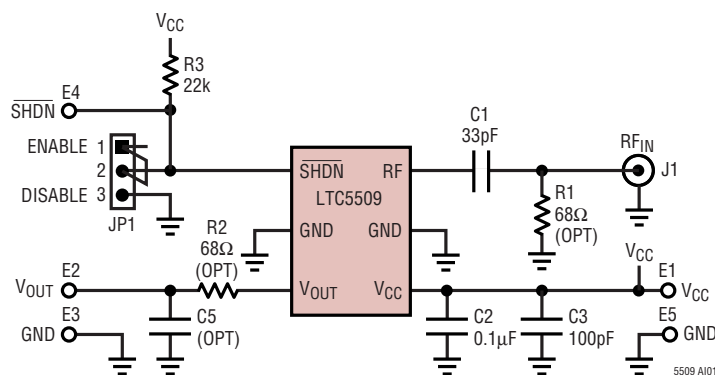

PACKAGE DESCRIPTION

SC6 Package
6-Lead Plastic SC70
 (Reference LTC DWG # 05-08-1638)

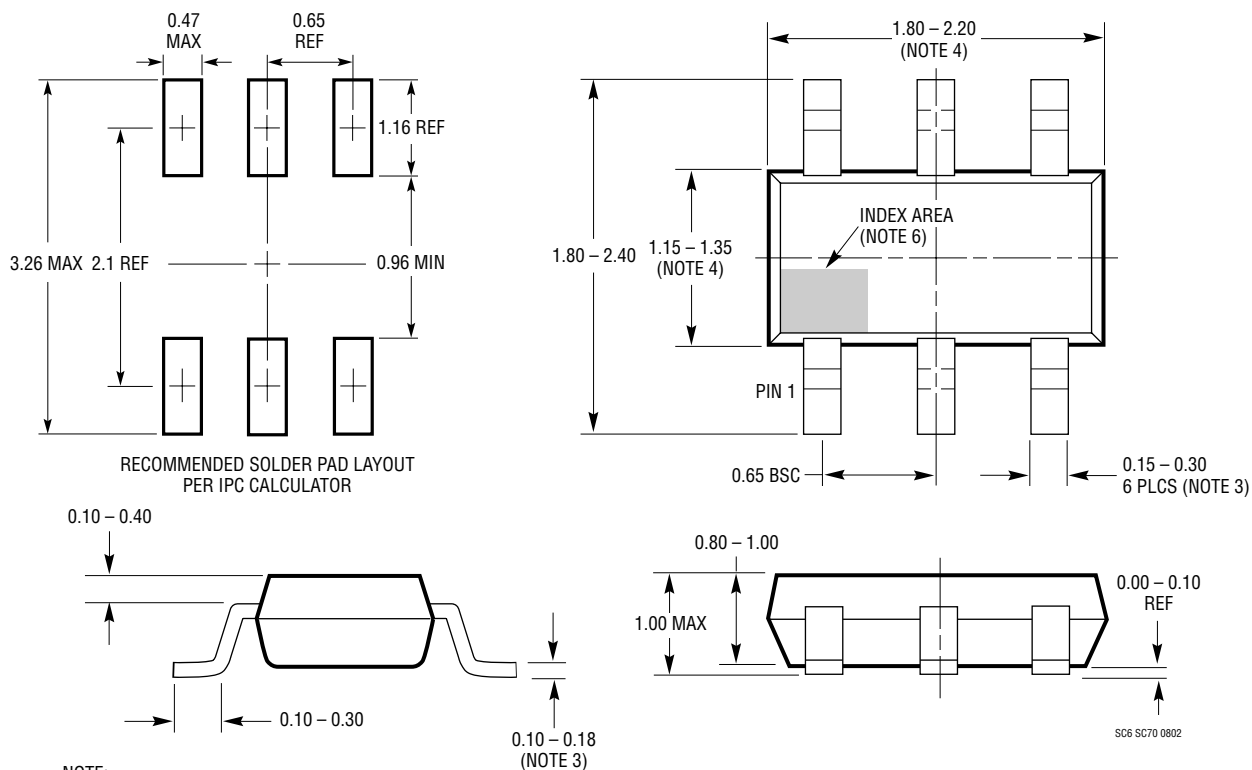

NOTE:

1. DIMENSIONS ARE IN MILLIMETERS
2. DRAWING NOT TO SCALE
3. DIMENSIONS ARE INCLUSIVE OF PLATING
4. DIMENSIONS ARE EXCLUSIVE OF MOLD FLASH AND METAL BURR
5. MOLD FLASH SHALL NOT EXCEED 0.254mm
6. DETAILS OF THE PIN 1 IDENTIFIER ARE OPTIONAL, BUT MUST BE LOCATED WITHIN THE INDEX AREA
7. EIAJ PACKAGE REFERENCE IS EIAJ SC-70

RELATED PARTS

PART NUMBER	DESCRIPTION	COMMENTS
RF Power Controllers		
LTC1757A	RF Power Controller	Multiband GSM/DCS/GPRS Mobile Phones
LTC1758	RF Power Controller	Multiband GSM/DCS/GPRS Mobile Phones
LTC1957	RF Power Controller	Multiband GSM/DCS/GPRS Mobile Phones
LTC4400	SOT-23 RF PA Controller	Multiband GSM/DCS/GPRS Phones, 45dB Dynamic Range, 450kHz Loop BW
LTC4401	SOT-23 RF PA Controller	Multiband GSM/DCS/GPRS Phones, 45dB Dynamic Range, 250kHz Loop BW
LTC4403	RF Power Controller for EDGE/TDMA	Multiband GSM/GPRS/EDGE Mobile Phones
LT [®] 5500	RF Front End	Dual LNA gain Setting +13.5dB/-14dB at 2.5GHz, Double-Balanced Mixer, $1.8V \leq V_{SUPPLY} \leq 5.25V$
LT5502	400MHz Quadrature Demodulator with RSSI	1.8V to 5.25V Supply, 70MHz to 400MHz IF, 84dB Limiting Gain, 90dB RSSI Range
LT5503	1.2GHz to 2.7GHz Direct IQ Modulator and Up Converting Mixer	1.8V to 5.25V Supply, Four-Step RF Power Control, 120MHz Modulation Bandwidth
LT5504	800MHz to 2.7GHz RF Measuring Receiver	80dB Dynamic Range, Temperature Compensated, 2.7V to 5.5V Supply
LTC5505	300MHz to 3.5GHz RF Power Detector	>40dB Dynamic Range, Temperature Compensated, 2.7V to 6V Supply
LT5506	500MHz Quadrature IF Demodulator with VGA	1.8V to 5.25V Supply, 40MHz to 500MHz IF, -4dB to 57dB Linear Power Gain
LTC5507	100kHz to 1GHz RF Power Detector	48dB Dynamic Range, Temperature Compensated, 2.7V to 6V Supply
LTC5508	300MHz to 7GHz RF Power Detector	SC70 Package
LT5511	High Signal Level Up Converting Mixer	RF Output to 3GHz, 17dBm IIP3, Integrated LO Buffer
LT5512	High Signal Level Down Converting Mixer	DC-3GHz, 20dBm IIP3, Integrated LO Buffer