



Chipsmall Limited consists of a professional team with an average of over 10 year of expertise in the distribution of electronic components. Based in Hongkong, we have already established firm and mutual-benefit business relationships with customers from,Europe,America and south Asia,supplying obsolete and hard-to-find components to meet their specific needs.

With the principle of “Quality Parts,Customers Priority,Honest Operation,and Considerate Service”,our business mainly focus on the distribution of electronic components. Line cards we deal with include Microchip,ALPS,ROHM,Xilinx,Pulse,ON,Everlight and Freescale. Main products comprise IC,Modules,Potentiometer,IC Socket,Relay,Connector.Our parts cover such applications as commercial,industrial, and automotives areas.

We are looking forward to setting up business relationship with you and hope to provide you with the best service and solution. Let us make a better world for our industry!



Contact us

Tel: +86-755-8981 8866 Fax: +86-755-8427 6832

Email & Skype: info@chipsmall.com Web: www.chipsmall.com

Address: A1208, Overseas Decoration Building, #122 Zhenhua RD., Futian, Shenzhen, China



T-13/4 (5mm) Ultra Bright

LTL2F3VxKNT	8 degree
LTL2H3VxKNT	15 degree
LTL2P3VxKNT	22 degree
LTL2R3VxKNT	30 degree

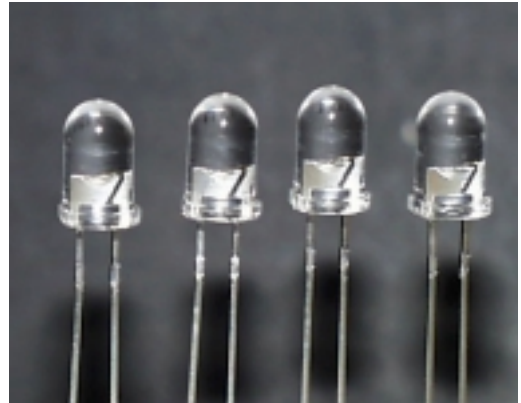
**Features**

- High luminous intensity output.
- Low power consumption.
- High efficiency.
- Versatile mounting on P.C. board or panel.
- I.C. compatible / low current requirement.
- Popular T-13/4 diameter.

Description

The source color devices are made with Aluminum Indium Gallium Phosphide on Gallium Arsenide light emitting diode. The devices are made with water clear epoxy package, And with 8, 15, 22 and 30 degrees of viewing angle.

Application

- Message sign.
- Traffic sign

Devices

Part No. (LTL)	Lens	Source Color
2F3VRKNT / 2H3VRKNT 2P3VRKNT / 2R3VRKNT	Water Clear	AllnGap Super Red
2F3VEKNT / 2H3VEKNT 2P3VEKNT / 2R3VEKNT	Water Clear	AllnGap Red
2F3VHKNT / 2H3VHKNT 2P3VHKNT / 2R3VHKNT	Water Clear	AllnGap Red Orange
2F3VAKNT / 2H3VAKNT 2P3VAKNT / 2R3VAKNT	Water Clear	AllnGap Red Orange
2F3VFKNT / 2H3VFKNT 2P3VFKNT / 2R3VFKNT	Water Clear	AllnGap Yellow Orange
2F3VYKNT / 2H3VYKNT 2P3VYKNT / 2R3VYKNT	Water Clear	AllnGap Amber Yellow
2F3VSKNT / 2H3VSKNT 2P3VSKNT / 2R3VSKNT	Water Clear	AllnGap Yellow

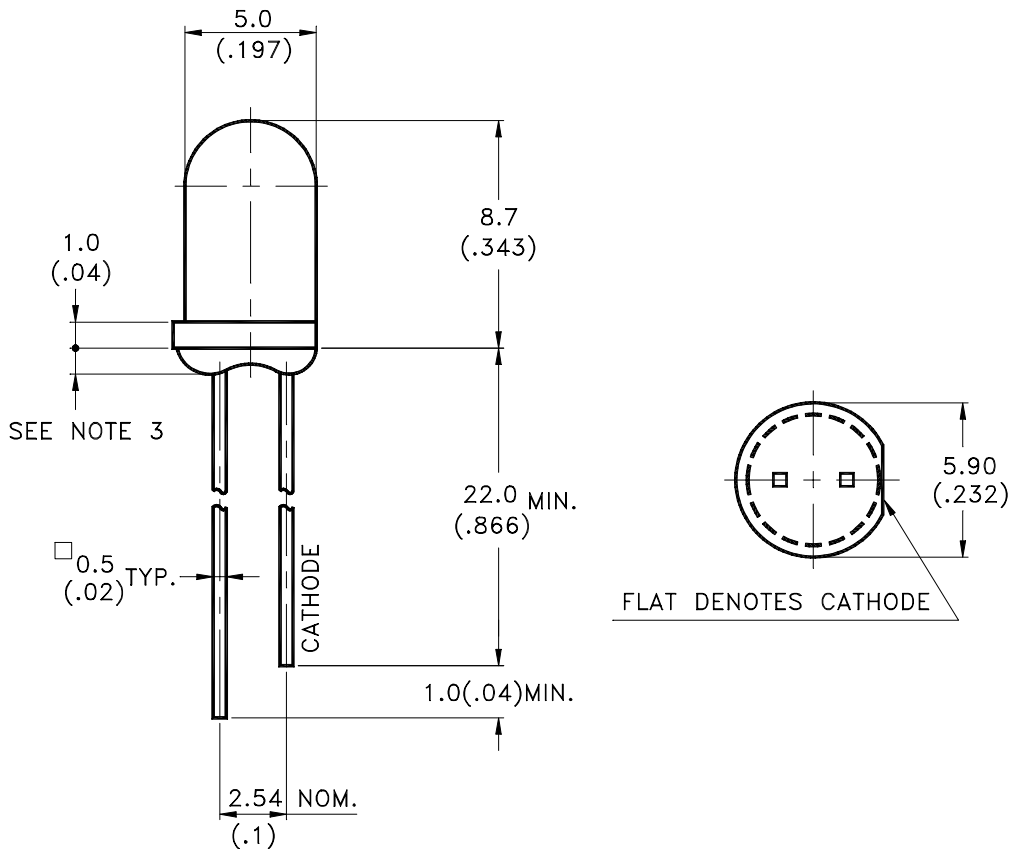
Package Dimensions

Notes:

1. All dimensions are in millimeters (inches).
2. Tolerance is $\pm 0.25\text{mm}$ (.010") unless otherwise noted.
3. Protruded resin under flange is 1.0mm (.04") max.
4. Lead spacing is measured where the leads emerge from the package.
5. Specifications are subject to change without notice.

Absolute Maximum Ratings at TA=25°C

Parameter	Super Red	Red	Red Orange	Red Orange	Yellow Orange	Amber Yellow	Yellow	Unit
Power Dissipation	120	120	120	120	120	120	120	mW
Peak Forward Current (1/10 Duty Cycle, 0.1ms Pulse Width)	130	130	90	90	90	90	90	mA
Continuous Forward Current	50	50	50	50	50	50	50	mA
Derating Linear From 70°C	0.6	0.6	0.6	0.6	0.6	0.6	0.6	mA / °C
Reverse Voltage (IR =100 μA)	5	5	5	5	5	5	5	V
Operating Temperature Range	-40°C to + 100°C							
Storage Temperature Range	-55°C to + 100°C							
Lead Soldering Temperature [1.6mm(.063") From Body]	260°C for 5 Seconds							

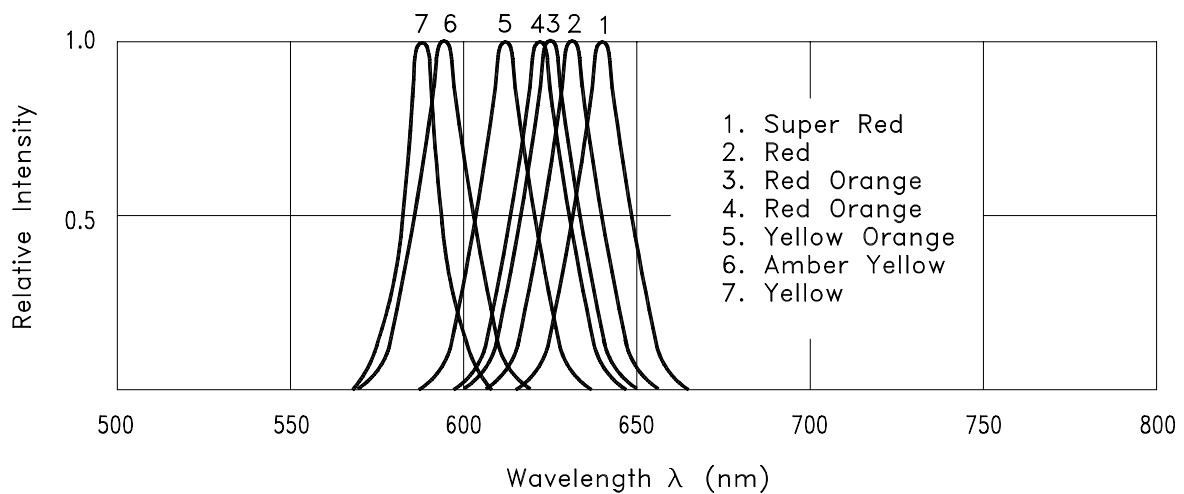

Fig.1 Relative Intensity vs. Wavelength



Electrical / Optical Characteristics at TA=25°C (F Series)

Parameter	Symbol	Part No. (LTL)	Min.	Typ.	Max.	Unit	Test Condition
Luminous Intensity	I _v	2F3VRKNT	3200	5500		mcd	I _F = 20mA Note 1 Note 2
		2F3VEKNT	4200	7200			
		2F3VHKNT	4200	7800			
		2F3VAKNT	4200	7800			
		2F3VFKNT	4200	7800			
		2F3VYKNT	4200	7800			
		2F3VSKNT	4200	7200			
Viewing Angle	2 θ _{1/2}			8		deg	Note 3 (Fig.5)
Peak Emission Wavelength	λ _P	2F3VRKNT		639		nm	Measurement @ peak (Fig.1)
		2F3VEKNT		632			
		2F3VHKNT		624			
		2F3VAKNT		621			
		2F3VFKNT		611			
		2F3VYKNT		595			
		2F3VSKNT		588			
Dominant Wavelength	λ _d	2F3VRKNT		631		nm	Note 5
		2F3VEKNT		624			
		2F3VHKNT		618			
		2F3VAKNT		615			
		2F3VFKNT		605			
		2F3VYKNT		592			
		2F3VSKNT		587			
Spectral Line Half-Width	Δλ	2F3VRKNT		20		nm	
		2F3VEKNT		20			
		2F3VHKNT		18			
		2F3VAKNT		18			
		2F3VFKNT		17			
		2F3VYKNT		15			
		2F3VSKNT		15			
Forward Voltage	V _F	2F3VRKNT		1.9	2.3	V	I _F = 20mA
		2F3VEKNT		2.0	2.4		
		2F3VHKNT		2.0	2.4		
		2F3VAKNT		2.0	2.4		
		2F3VFKNT		2.0	2.4		
		2F3VYKNT		2.0	2.4		
		2F3VSKNT		2.0	2.4		
Reverse Current	I _R				100	μA	V _R = 5V
Capacitance	C			40		pF	V _F = 0, f = 1 MHz

NOTES:

- Luminous intensity is measured with a light sensor and filter combination that approximates the CIE eye-response curve.
- Luminous intensity rank classified products support two ranks.
- θ 1/2 is the off-axis angle at which the luminous intensity is half the axial luminous intensity.
- I_v classification code is marked on each packing bag.
- The dominant wavelength, λ_d is derived from the CIE chromaticity diagram and represents the single wavelength which defines the color of the device.



Electrical / Optical Characteristics at TA=25°C (H Series)

Parameter	Symbol	Part No. (LTL)	Min.	Typ.	Max.	Unit	Test Condition
Luminous Intensity	I _v	2H3VRKNT	1500	2400		mcd	I _F = 20mA Note 1 Note 2
		2H3VEKNT	1900	3100			
		2H3VHKNT	1900	3400			
		2H3VAKNT	1900	3400			
		2H3VFKNT	1900	3400			
		2H3VYKNT	1900	3400			
		2H3VSKNT	1900	3100			
Viewing Angle	2 θ _{1/2}			15		deg	Note 3 (Fig.5)
Peak Emission Wavelength	λ _P	2H3VRKNT		639		nm	Measurement @ peak (Fig.1)
		2H3VEKNT		632			
		2H3VHKNT		624			
		2H3VAKNT		621			
		2H3VFKNT		611			
		2H3VYKNT		595			
		2H3VSKNT		588			
Dominant Wavelength	λ _d	2H3VRKNT		631		nm	Note 5
		2H3VEKNT		624			
		2H3VHKNT		618			
		2H3VAKNT		615			
		2H3VFKNT		605			
		2H3VYKNT		592			
		2H3VSKNT		587			
Spectral Line Half-Width	Δλ	2H3VRKNT		20		nm	
		2H3VEKNT		20			
		2H3VHKNT		18			
		2H3VAKNT		18			
		2H3VFKNT		17			
		2H3VYKNT		15			
		2H3VSKNT		15			
Forward Voltage	V _F	2H3VRKNT		1.9	2.3	V	I _F = 20mA
		2H3VEKNT		2.0	2.4		
		2H3VHKNT		2.0	2.4		
		2H3VAKNT		2.0	2.4		
		2H3VFKNT		2.0	2.4		
		2H3VYKNT		2.0	2.4		
		2H3VSKNT		2.0	2.4		
Reverse Current	I _R				100	μA	V _R = 5V
Capacitance	C			40		pF	V _F = 0, f = 1 MHz

NOTES:

- Luminous intensity is measured with a light sensor and filter combination that approximates the CIE eye-response curve.
- Luminous intensity rank classified products support two ranks.
- θ 1/2 is the off-axis angle at which the luminous intensity is half the axial luminous intensity.
- I_v classification code is marked on each packing bag.
- The dominant wavelength, λ_d is derived from the CIE chromaticity diagram and represents the single wavelength which Define the color of the device.



Electrical / Optical Characteristics at TA=25°C (P Series)

Parameter	Symbol	Part No. (LTL)	Min.	Typ.	Max.	Unit	Test Condition
Luminous Intensity	I _v	2P3VRKNT	880	1400		mad	I _F = 20mA Note 1 Note 2
		2P3VEKNT	1150	1900			
		2P3VHKNT	1150	2000			
		2P3VAKNT	1150	2000			
		2P3VFKNT	1150	2000			
		2P3VYKNT	1150	2000			
		2P3VSKNT	1150	1900			
Viewing Angle	2 θ _{1/2}			22		deg	Note 3 (Fig.5)
Peak Emission Wavelength	λ _P	2P3VRKNT		639		nm	Measurement @ peak (Fig.1)
		2P3VEKNT		632			
		2P3VHKNT		624			
		2P3VAKNT		621			
		2P3VFKNT		611			
		2P3VYKNT		595			
		2P3VSKNT		588			
Dominant Wavelength	λ _d	2P3VRKNT		631		nm	Note 5
		2P3VEKNT		624			
		2P3VHKNT		618			
		2P3VAKNT		615			
		2P3VFKNT		605			
		2P3VYKNT		592			
		2P3VSKNT		587			
Spectral Line Half-Width	Δλ	2P3VRKNT		20		nm	
		2P3VEKNT		20			
		2P3VHKNT		18			
		2P3VFKNT		18			
		2P3VFKNT		17			
		2P3VYKNT		16			
		2P3VSKNT		15			
Forward Voltage	V _F	2P3VRKNT		1.9	2.3	V	I _F = 20mA
		2P3VEKNT		2.0	2.4		
		2P3VHKNT		2.0	2.4		
		2P3VAKNT		2.0	2.4		
		2P3VFKNT		2.0	2.4		
		2P3VYKNT		2.0	2.4		
		2P3VSKNT		2.0	2.4		
Reverse Current	I _R				100	μA	V _R = 5V
Capacitance	C			40		pF	V _F = 0, f = 1 MHz

NOTES:

- Luminous intensity is measured with a light sensor and filter combination that approximates the CIE eye-response curve.
- Luminous intensity rank classified products support two ranks.
- θ 1/2 is the off-axis angle at which the luminous intensity is half the axial luminous intensity.
- I_v classification code is marked on each packing bag.
- The dominant wavelength, λ_d is derived from the CIE chromaticity diagram and represents the single wavelength which defines the color of the device.



Electrical / Optical Characteristics at TA=25°C (R Series)

Parameter	Symbol	Part No. (LTL)	Min.	Typ.	Max.	Unit	Test Condition
Luminous Intensity	Iv	2R3VRKNT	520	990		mcd	IF = 20mA Note 1 Note 2
		2R3VEKNT	680	1200			
		2R3VHKNT	680	1300			
		2R3VAKNT	680	1300			
		2R3VFKNT	680	1300			
		2R3VYKNT	680	1300			
		2R3VSKNT	680	1200			
Viewing Angle	2 θ1/2			30		deg	Note 3 (Fig.5)
Peak Emission Wavelength	λP	2R3VRKNT		639		nm	Measurement @ peak (Fig.1)
		2R3VEKNT		632			
		2R3VHKNT		624			
		2R3VAKNT		621			
		2R3VFKNT		611			
		2R3VYKNT		595			
		2R3VSKNT		588			
Dominant Wavelength	λd	2R3VRKNT		631		nm	Note 5
		2R3VEKNT		624			
		2R3VHKNT		618			
		2R3VAKNT		615			
		2R3VFKNT		605			
		2R3VYKNT		592			
		2R3VSKNT		587			
Spectral Line Half-Width	Δλ	2R3VRKNT		20		nm	
		2R3VEKNT		20			
		2R3VHKNT		18			
		2R3VAKNT		18			
		2R3VFKNT		17			
		2R3VYKNT		16			
		2R3VSKNT		15			
Forward Voltage	VF	2R3VRKNT		1.9	2.3	V	IF = 20mA
		2R3VEKNT		2.0	2.4		
		2R3VHKNT		2.0	2.4		
		2R3VAKNT		2.0	2.4		
		2R3VFKNT		2.0	2.4		
		2R3VYKNT		2.0	2.4		
		2R3VSKNT		2.0	2.4		
Reverse Current	IR				100	μA	VR = 5V
Capacitance	C			40		pF	VF = 0, f = 1 MHz

NOTES:

- Luminous intensity is measured with a light sensor and filter combination that approximates the CIE eye-response curve.
- Luminous intensity rank classified products support two ranks.
- θ 1/2 is the off-axis angle at which the luminous intensity is half the axial luminous intensity.
- Iv classification code is marked on each packing bag.
- The dominant wavelength, λd is derived from the CIE chromaticity diagram and represents the single wavelength which defines the color of the device.

Typical Electrical / Optical Characteristics Curves

(25°C Ambient Temperature Unless Otherwise Noted)

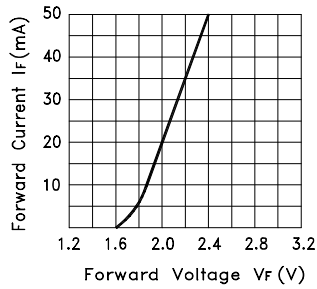

Fig.2 Forward Current vs. Forward Voltage

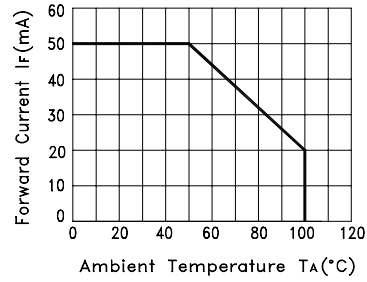

Fig.3 Forward Current Derating Curve

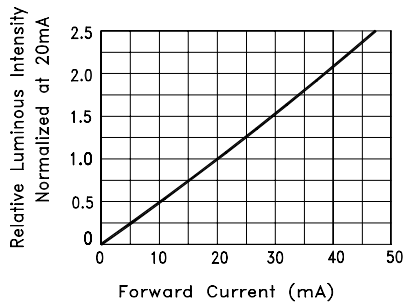

Fig.4 Relative Luminous Intensity vs. Forward Current

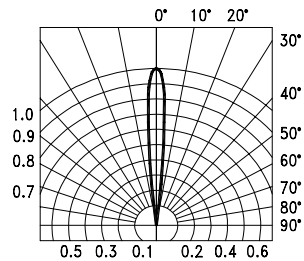

Fig.5-1 Spatial Distribution

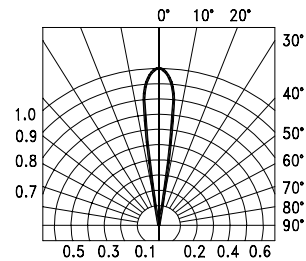

Fig.5-2 Spatial Distribution

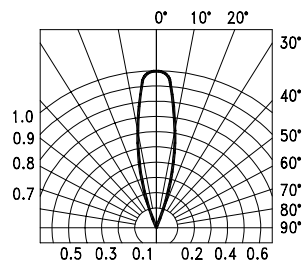

Fig.5-3 Spatial Distribution

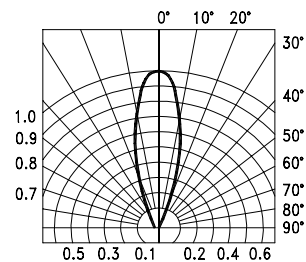

Fig.5-4 Spatial Distribution