



Chipsmall Limited consists of a professional team with an average of over 10 year of expertise in the distribution of electronic components. Based in Hongkong, we have already established firm and mutual-benefit business relationships with customers from,Europe,America and south Asia,supplying obsolete and hard-to-find components to meet their specific needs.

With the principle of “Quality Parts,Customers Priority,Honest Operation,and Considerate Service”,our business mainly focus on the distribution of electronic components. Line cards we deal with include Microchip,ALPS,ROHM,Xilinx,Pulse,ON,Everlight and Freescale. Main products comprise IC,Modules,Potentiometer,IC Socket,Relay,Connector.Our parts cover such applications as commercial,industrial, and automotives areas.

We are looking forward to setting up business relationship with you and hope to provide you with the best service and solution. Let us make a better world for our industry!



## Contact us

Tel: +86-755-8981 8866 Fax: +86-755-8427 6832

Email & Skype: info@chipsmall.com Web: www.chipsmall.com

Address: A1208, Overseas Decoration Building, #122 Zhenhua RD., Futian, Shenzhen, China



## Features

- \* Designed for ease in circuit board assembly.
- \* Black case enhance contrast ratio.
- \* Solid state light source.
- \* Reliable and rugged.

## Package Dimensions

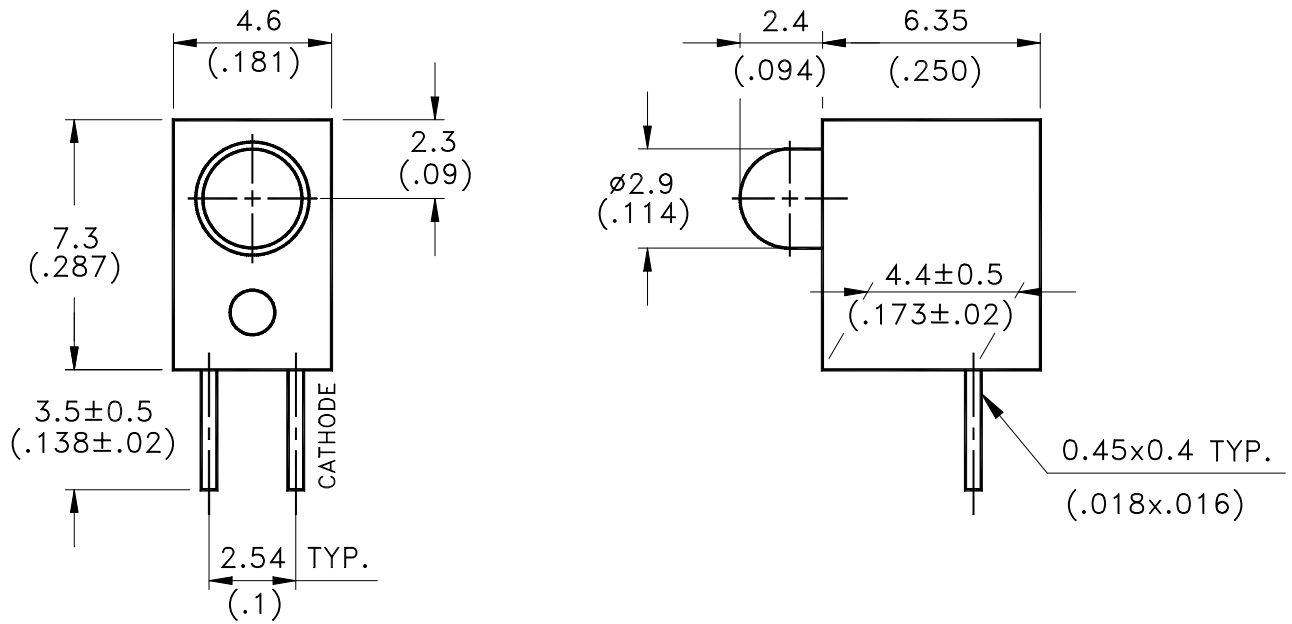

Part No.	Lens	Source Color
LTL-4211N	Red Diffused	Bright Red

### Notes:

1. All dimensions are in millimeters (inches).
2. Tolerance is  $\pm 0.25\text{mm}(.010\text{'})$  unless otherwise noted.
3. The holder color is black.
5. The LED lamp is LTL-4211N.



**Absolute Maximum Ratings at Ta=25°C**

Parameter	Maximum Rating	Unit
Power Dissipation	40	mW
Peak Forward Current (1/10 Duty Cycle, 0.1ms Pulse Width)	60	mA
Continuous Forward Current	15	mA
Derating Linear From 50°C	0.2	mA/°C
Reverse Voltage	5	V
Operating Temperature Range	-55°C to + 100°C	
Storage Temperature Range	-55°C to + 100°C	
Lead Soldering Temperature [1.6mm(.063") From Body]	260°C for 5 Seconds	

### Electrical Optical Characteristics at Ta=25°C

Parameter	Symbol	Part No. LTL-	Min.	Typ.	Max.	Unit	Test Condition
Luminous Intensity	I <sub>v</sub>	4211NHBP	1.3	4.4		mcd	I <sub>F</sub> = 10mA Note 1,4
Viewing Angle	2θ <sub>1/2</sub>	4211NHBP		60		deg	Note 2 (Fig.6)
Peak Emission Wavelength	λ <sub>p</sub>	4211NHBP		697		nm	Measurement @Peak (Fig.1)
Dominant Wavelength	λ <sub>d</sub>	4211NHBP		657		nm	Note 3
Spectral Line Half-Width	Δλ	4211NHBP		90		nm	
Forward Voltage	V <sub>F</sub>	4211NHBP		2.1	2.6	V	I <sub>F</sub> = 20mA
Reverse Current	I <sub>R</sub>	4211NHBP			100	μA	V <sub>R</sub> = 5V
Capacitance	C	4211NHBP		55		pF	V <sub>F</sub> = 0, f = 1MHz

- Note: 1. Luminous intensity is measured with a light sensor and filter combination that approximates the CIE eye-response curve.
2. θ<sub>1/2</sub> is the off-axis angle at which the luminous intensity is half the axial luminous intensity.
3. The dominant wavelength, λ<sub>d</sub> is derived from the CIE chromaticity diagram and represents the single wavelength which defines the color of the device.
4. I<sub>v</sub> needs ±15% additional for guaranteed limits.

Property of Lite-On Only

## Typical Electrical / Optical Characteristics Curves

(25°C Ambient Temperature Unless Otherwise Noted)

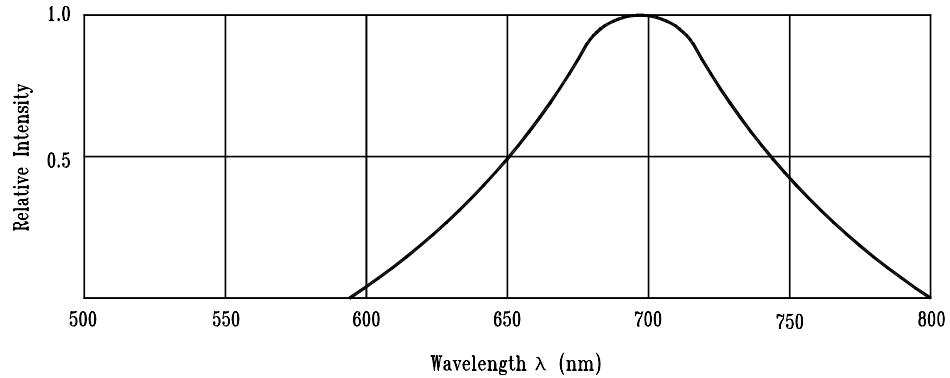

Fig.1 Relative Intensity vs. Wavelength

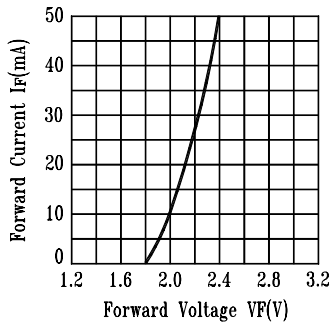

Fig.2 Forward Current vs. Forward Voltage

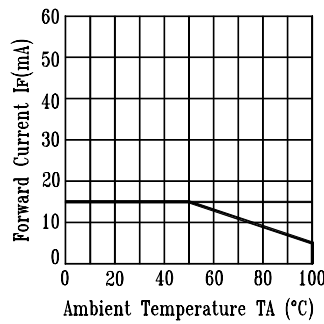

Fig.3 Forward Current Derating Curve

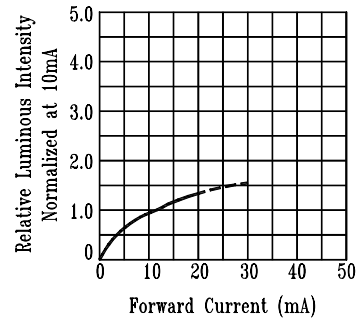

Fig.4 Relative Luminous Intensity vs. Forward Current

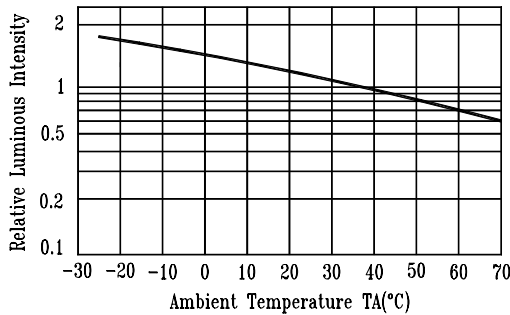

Fig.5 Luminous Intensity vs. Ambient Temperature

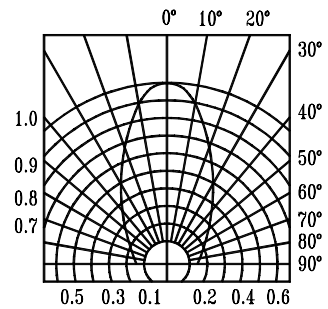

Fig.6 Spatial Distribution