



Chipsmall Limited consists of a professional team with an average of over 10 year of expertise in the distribution of electronic components. Based in Hongkong, we have already established firm and mutual-benefit business relationships with customers from,Europe,America and south Asia,supplying obsolete and hard-to-find components to meet their specific needs.

With the principle of “Quality Parts,Customers Priority,Honest Operation,and Considerate Service”,our business mainly focus on the distribution of electronic components. Line cards we deal with include Microchip,ALPS,ROHM,Xilinx,Pulse,ON,Everlight and Freescale. Main products comprise IC,Modules,Potentiometer,IC Socket,Relay,Connector.Our parts cover such applications as commercial,industrial, and automotives areas.

We are looking forward to setting up business relationship with you and hope to provide you with the best service and solution. Let us make a better world for our industry!



Contact us

Tel: +86-755-8981 8866 Fax: +86-755-8427 6832

Email & Skype: info@chipsmall.com Web: www.chipsmall.com

Address: A1208, Overseas Decoration Building, #122 Zhenhua RD., Futian, Shenzhen, China



Features

- * Bright Red and Green chips are matched for uniform light output.
- * Rectangular type package.
- * I.C. compatible
- * Low power consumption.

Package Dimensions

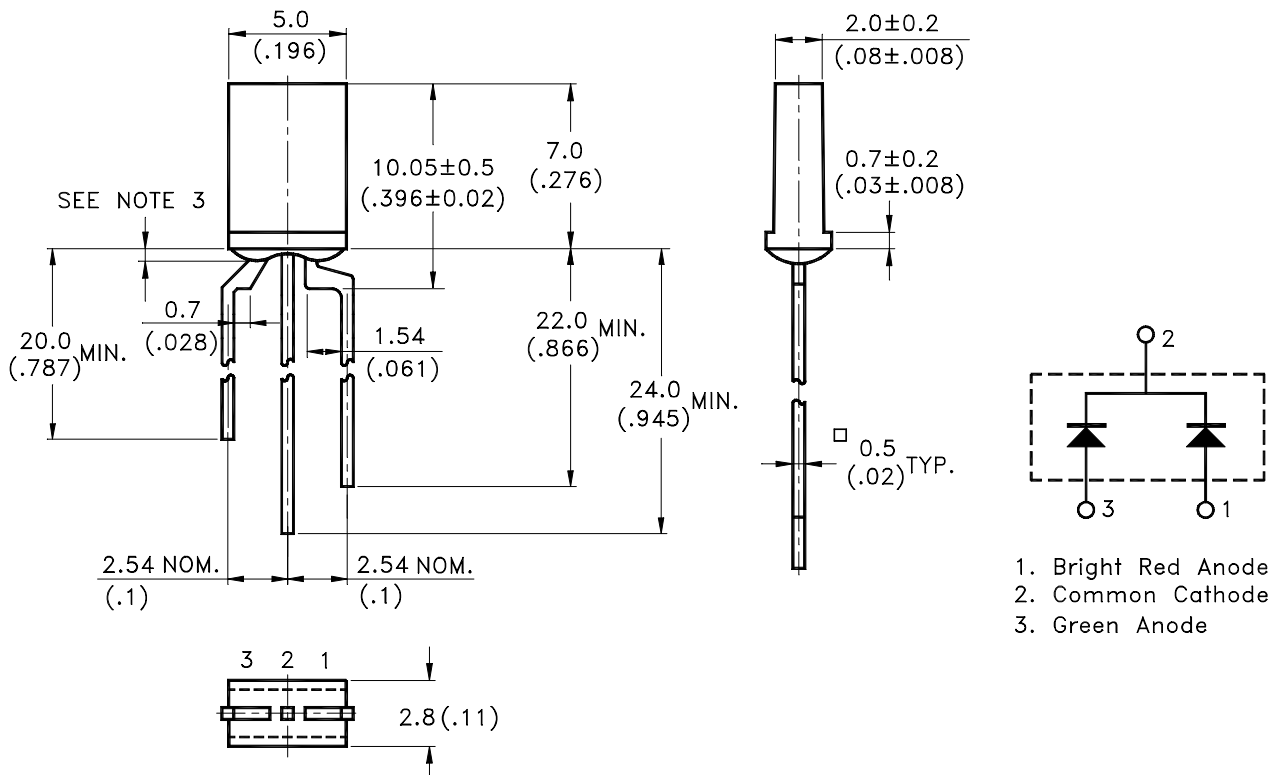

Part No.	Lens	Source Color
LTL-58EFJ	White Diffused	Bright Red / Green

Notes:

1. All dimensions are in millimeters (inches).
2. Tolerance is ± 0.25mm(.010") unless otherwise noted.
3. Protruded resin under flange is 1.0mm(.04") max.
4. Lead spacing is measured where the leads emerge from the package.
5. Specification are subject to change without notice.



Absolute Maximum Ratings at TA=25°C

Parameter	Bright Red	Green	Unit
Power Dissipation	40	100	mW
Peak Forward Current (1/10 Duty Cycle, 0.1ms Pulse Width)	60	120	mA
Continuous Forward Current	15	30	mA
Derating Linear From 50°C	0.2	0.4	mA/°C
Reverse Voltage	5	5	V
Operating Temperature Range	-55°C to + 100°C		
Storage Temperature Range	-55°C to + 100°C		
Lead Soldering Temperature [1.6mm(.063") From Body]	260°C for 5 Seconds		

Electrical Optical Characteristics at TA=25°C

Parameter	Symbol	Color	Min.	Typ.	Max.	Unit	Test Condition
Luminous Intensity	I _v	Bright Red Green	0.3 1.7	0.6 5.6		mcd	I _F = 10mA Note 1,4
Viewing Angle	2θ _{1/2}	Bright Red Green		100 100		deg	Note 2 (Fig.6)
Peak Emission Wavelength	λ _p	Bright Red Green		697 565		nm	Measurement @Peak (Fig.1)
Dominant Wavelength	λ _d	Bright Red Green		657 569		nm	Note 3
Spectral Line Half-Width	Δλ	Bright Red Green		90 30		nm	
Forward Voltage	V _F	Bright Red Green		2.1 2.1	2.6 2.6	V	I _F = 20mA
Reverse Current	I _R	Bright Red Green			100	μA	V _R = 5V
Capacitance	C	Bright Red Green		55 35		pF	V _F = 0, f = 1MHz

- Note: 1. Luminous intensity is measured with a light sensor and filter combination that approximates the CIE (Commission International De L'Eclairage) eye-response curve.
2. θ_{1/2} is the off-axis angle at which the luminous intensity is half the axial luminous intensity.
3. The dominant wavelength, λ_d is derived from the CIE chromaticity diagram and represents the single wavelength which defines the color of the device.
4. The stated maximum ratings refer to one chip.

Property of Lite-On Only

Typical Electrical / Optical Characteristics Curves

(25°C Ambient Temperature Unless Otherwise Noted)

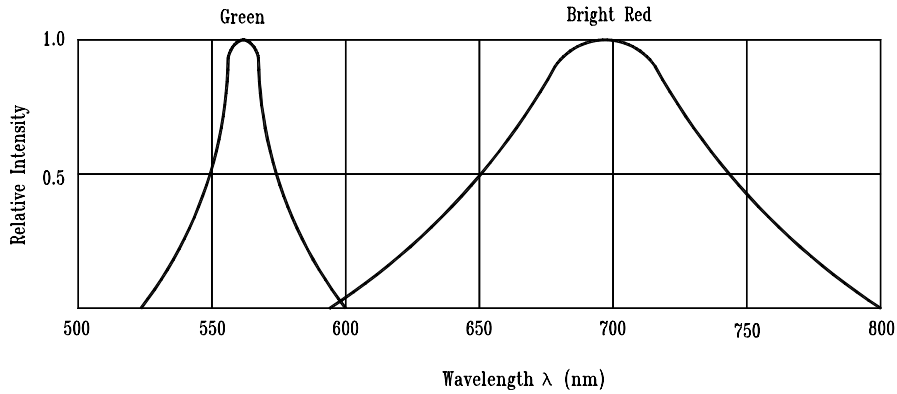

Fig.1 Relative Intensity vs. Wavelength

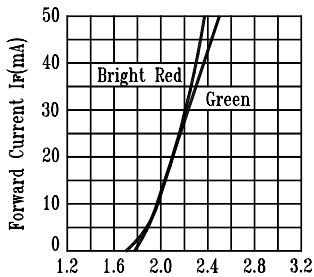

Fig.2 Forward Current vs. Forward Voltage

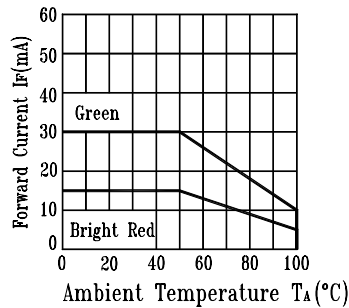

Fig.3 Forward Current Derating Curve

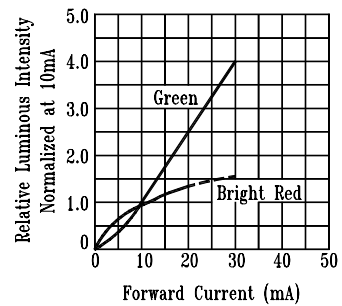

Fig.4 Relative Luminous Intensity vs. Forward Current

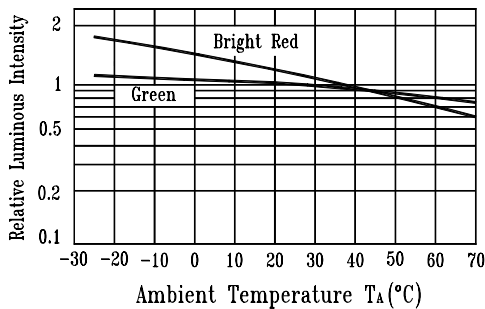

Fig.5 Luminous Intensity vs. Ambient Temperature

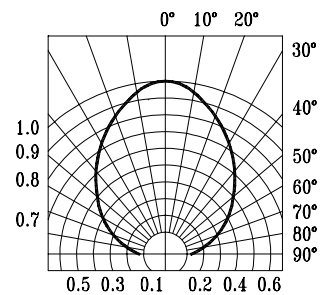

Fig.6 Spatial Distribution