



Chipsmall Limited consists of a professional team with an average of over 10 year of expertise in the distribution of electronic components. Based in Hongkong, we have already established firm and mutual-benefit business relationships with customers from,Europe,America and south Asia,supplying obsolete and hard-to-find components to meet their specific needs.

With the principle of “Quality Parts,Customers Priority,Honest Operation,and Considerate Service”,our business mainly focus on the distribution of electronic components. Line cards we deal with include Microchip,ALPS,ROHM,Xilinx,Pulse,ON,Everlight and Freescale. Main products comprise IC,Modules,Potentiometer,IC Socket,Relay,Connector.Our parts cover such applications as commercial,industrial, and automotives areas.

We are looking forward to setting up business relationship with you and hope to provide you with the best service and solution. Let us make a better world for our industry!



Contact us

Tel: +86-755-8981 8866 Fax: +86-755-8427 6832

Email & Skype: info@chipsmall.com Web: www.chipsmall.com

Address: A1208, Overseas Decoration Building, #122 Zhenhua RD., Futian, Shenzhen, China



Super Flux LEDs

LTL913SEKS
LTL913SHKS
LTL913SYKS
LTL913TBKS
LTL913TGKS



Selection Guide

Part No.	Color	Φv (mlm)	Va(deg.)	λd (nm)
LTL913SEKS	Red	3750	100 * 40	628
LTL913SHKS	Red-Orange	3750	100 * 40	620
LTL913SYKS	Amber	2090	100 * 40	594
LTL913TBKS	Blue	550	100 * 40	470
LTL913TGKS	Green	1600	100 * 40	525

Benefits

- Fewer LEDs Required
- Lower lighting System Cost

Applications

- Automotive Lighting
 - CHMSL
 - Stop Lamp
 - Rear Turn Signal Lamp
 - Front Turn Signal Lamp
 - Indirect Lighting
 - Signs and Signals



Features

- High Current Operation
- High Flux Output
- Low Thermal Resistance
- Low Profile
- Wide Viewing Angle
- Meet SAE/ ECE/ JIS Automotive Color Requirement
- Tube Package for Automatic Loading and Insertion Process

Description

These parts are designed for high current operation and high flux output applications. In order to solve the high temperature produced by the higher current operation, the package’s design features better thermal management characteristics than other LED solutions coupled with an efficient optical design.

This package design allows the lighting designer to reduce the number of LEDs required as well as the overall lighting system cost. The low profile package can be easily coupled to reflectors or lenses to efficiently distribute light and provide the desired illuminated appearance. This product family employs the world’s brightest red, red-orange, amber, blue, cyan, green, and white LED materials etc., which allow designers to match the color of popular lighting applications, such as automotive lighting and electronic signs.

Devices				
Part No (LTL*)	Lens		Source	
	Color	Diffusion	Dice Source	Color
913SEKS	Water Clear	Non-Diffused	AllnGaP	Red
913SHKS	Water Clear	Non-Diffused	AllnGaP	Red-Orange
913SYKS	Water Clear	Non-Diffused	AllnGaP	Amber
913TBKS	Water Clear	Non-Diffused	InGaN	Blue
913TGKS	Water Clear	Non-Diffused	InGaN	Green

Package Dimensions

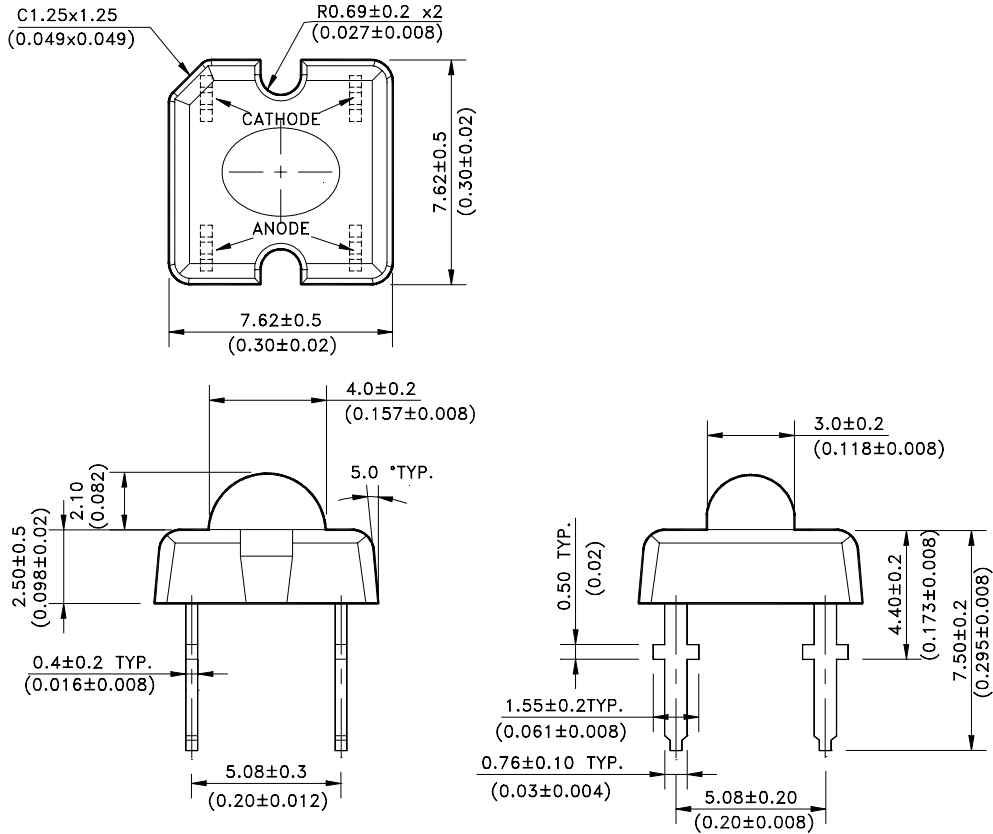

NOTES:

1. All dimensions are in millimeters (inches).
2. Protruded resin is 1.0mm (.04") max.
3. Lead spacing is measured where the leads emerge from the package.
4. Specifications are subject change to without notice.



Absolute Maximum Ratings at TA=25°C

Parameter	AllnGaP<Note3>	InGaN<Note4>	Unit
Power Dissipation	242	235	mW
Peak Forward Current (1/10 Duty Cycle, 0.1ms Pulse Width)	100	100	mA
Continuous Forward Current	70	50	mA
AllnGaP Derating Linear From 60°C InGaN Deraing Linear From 55 °C <Note2>	0.875	0.667	mA/°C
Reverse Voltage (IR =100 μA)	10	5	V
Operating Temperature Range	-40°C to + 100°C		
Storage Temperature Range	-55°C to + 100°C		
LED Junction Temperature	125°C		
Soldering Preheat Temperature	100°C for 30 Seconds		
Lead Soldering Temperature	260°C for 5 Seconds [1.5mm (.06") From Seating Plane]		

Notes:

1. Operation at currents below 10mA is not recommended.
2. Derating linear as shown in Fig. 4
3. AllnGaP devices: LTL91xSEKS, LTL91xSHKS, LTL91xSYKS.
4. InGaN devices: LTL91xTBKS, LTL91xTGKS.

Electrical / Optical Characteristics at T_A=25°C

Parameter	Symbol	Part No.	Min.	Typ.	Max.	Unit	Test Condition
Total Flux <Note1>	∅V	LTL913SEKS	1050	3750		mlm	IF=70mA
		LTL913SHKS	1050	3750			
		LTL913SYKS	1050	2090			
		LTL913TBKS	310	1100			IF=50mA
		LTL913TGKS	700	1600			
Luminous Intensity / Total Flux	I _v / ∅V	LTL913SXKS		0.8		mcd /mlm	IF=70mA
		LTL913TXKS					IF=50mA
Viewing Angle <Note2, Fig 5>	2θ 1/2	LTL913SXKS LTL913TXKS		100 *40		deg	
Peak Emission Wavelength <Fig 1>	λ _p	LTL913SEKSA		638		nm	IF=70mA
		LTL913SHKSA		626			
		LTL913SYKSA		596			
		LTL913TBKS		465			IF=50mA
		LTL913TGKS		518			
Dominant Wavelength <Note 3>	λ _d	LTL913SEKSA		628		nm	IF=70mA
		LTL913SHKSA		620			
		LTL913SYKSA		594			
		LTL913TBKS		470			IF=50mA
		LTL913TGKS		525			
Forward Voltage	VF	LTL913SxKSA	2.15	2.50	3.45	V	IF=70mA
		LTL913TxKS	-	4.0	4.7		IF=50mA
Reverse Voltage	VR	LTL913SxKSA LTL913TxKS	10 5	20 10		V	IR = 100 μA
Thermal resistance	R _{θ J-PIN}			125		°C/W	

- Note:
- ∅v is the total luminous flux output as measured with an integrating sphere.
 - θ 1/2 is the off-axis angle at which the luminous intensity is half the axial luminous intensity.
 - The dominant wavelength, λ_d is derived from the CIE chromaticity diagram and represents the single wavelength which defines the color of the device.

Property of Lite-On Only

Typical Electrical / Optical Characteristics Curves

(25°C Ambient Temperature Unless Otherwise Noted)

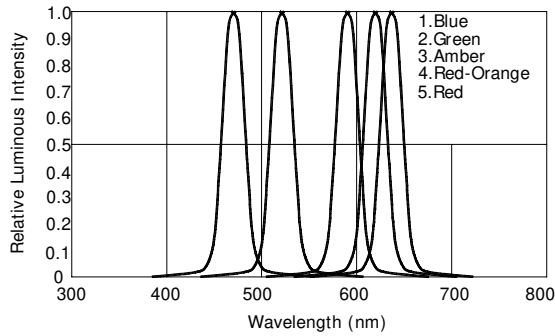

Fig.1 Relative Luminous Intensity vs. Wavelength

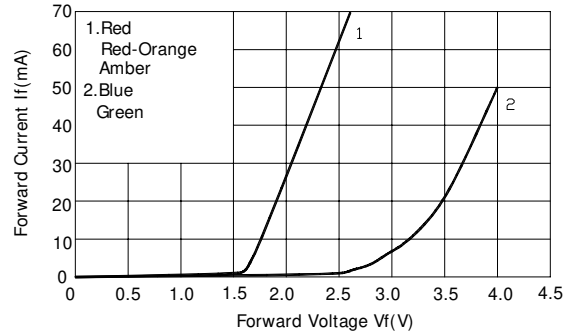

Fig.2 Forward Current vs. Forward Voltage

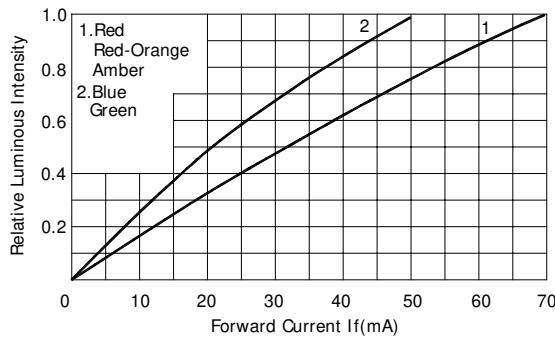

Fig.3 Relative Luminous Flux vs Forward Current

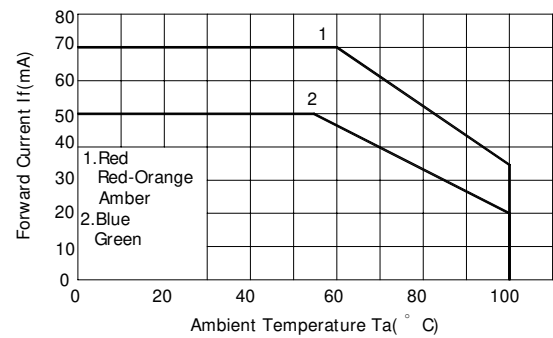

Fig.4 Forward Current vs. Ambient Temperature
($R_{\theta j-a}=300^{\circ}\text{C/W}$)

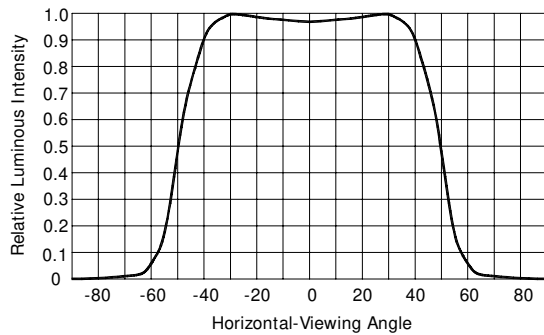

Fig.5a LTL913SxKS/LTL913TxKS
Relative Luminous Intensity vs. Viewing Angle

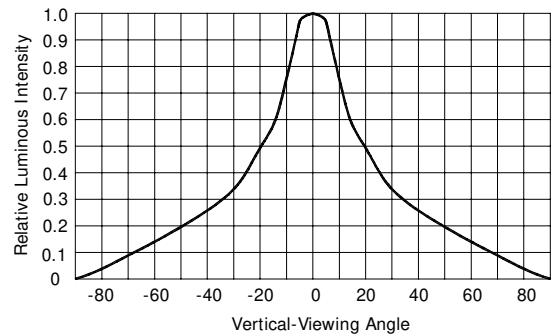

Fig.5b LTL913SxKS/LTL913TxKS
Relative Luminous Intensity vs. Viewing Angle



Bin Table of Piranha LEDs

Bin Code: BIN F HUE H2

1. Luminous Flux Bin Table

Bin	Luminous Flux (lm)	
	Min.	Max.
3X	210	310
3Y	310	470
3Z	470	700
A	700	1050
B	1050	1570
C	1570	2090
D	2090	2600
E	2600	3130
F	3130	3650
G	3650	4170
H	4170	5300
J	5300	6350
L	6350	8430

Note: Tolerance of each bin limit is $\pm 15\%$



2. Hue Bin Table

Hue Bin	Red-Orange	
	Min.	Max.
H1	613	616
H2	616	619
H3	619	631
Hue Bin	Amber	
	Min.	Max.
Y0	586	588
Y1	588	590
Y2	590	593
Y3	593	596
Y4	596	599
Y5	599	602
Hue Bin	Blue	
	Min.	Max.
B2	460	465
B3	465	470
B4	470	475
B5	475	480
Hue Bin	Green	
	Min.	Max.
G1	510	515
G2	515	520
G3	520	525
G4	525	530
G5	530	535
G6	535	540

Note: Tolerance of each bin limit is $\pm 2\text{nm}$

Property of Lite-On Only

Packing Spec

1. Tube: 65pcs

Dim: 520mm x 9.6mm x 11.8mm



2. Inner carton: 187 tubes x 65 pcs = 12,155 pcs

Dim: 530mm x 175mm x 128mm

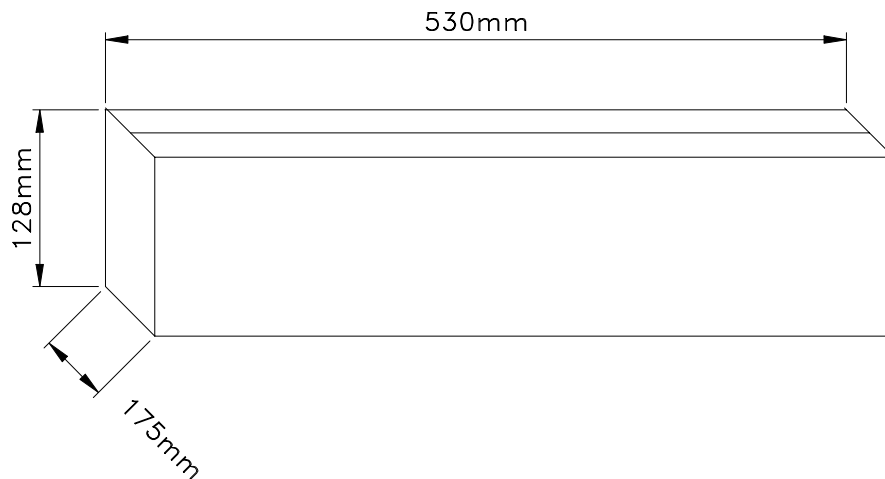

3. Outer carton: 4 inner cartons x 12,155 pcs = 48,620 pcs

Dim: 545mm x 370mm x 280mm

