



Chipsmall Limited consists of a professional team with an average of over 10 year of expertise in the distribution of electronic components. Based in Hongkong, we have already established firm and mutual-benefit business relationships with customers from,Europe,America and south Asia,supplying obsolete and hard-to-find components to meet their specific needs.

With the principle of “Quality Parts,Customers Priority,Honest Operation,and Considerate Service”,our business mainly focus on the distribution of electronic components. Line cards we deal with include Microchip,ALPS,ROHM,Xilinx,Pulse,ON,Everlight and Freescale. Main products comprise IC,Modules,Potentiometer,IC Socket,Relay,Connector.Our parts cover such applications as commercial,industrial, and automotives areas.

We are looking forward to setting up business relationship with you and hope to provide you with the best service and solution. Let us make a better world for our industry!



Contact us

Tel: +86-755-8981 8866 Fax: +86-755-8427 6832

Email & Skype: info@chipsmall.com Web: www.chipsmall.com

Address: A1208, Overseas Decoration Building, #122 Zhenhua RD., Futian, Shenzhen, China



SPI/Digital or I²C μModule Isolator with Adjustable ±12.5V and 5V Regulated Power

FEATURES

- 2500V_{RMS} for One Minute per UL1577 UL Recognized  File #E151738
- Isolated Adjustable DC Power:
 - 3V to 5V at Up to 30mA
 - ±12.5V at Up to 20mA
- No External Components Required
- SPI (LTM2883-S) or I²C (LTM2883-I) Options
- High Common Mode Transient Immunity: 30kV/μs
- High Speed Operation:
 - 10MHz Digital Isolation
 - 4MHz/8MHz SPI Isolation
 - 400kHz I²C Isolation
- 3.3V (LTM2883-3) or 5V (LTM2883-5) Operation
- 1.62V to 5.5V Logic Supply
- ±10kV ESD HBM Across the Isolation Barrier
- Maximum Continuous Working Voltage: 560V_{PEAK}
- Low Current Shutdown Mode (<10μA)
- Low Profile (15mm × 11.25mm × 3.42mm) BGA Package

APPLICATIONS

- Isolated SPI or I²C Interfaces
- Industrial Systems
- Test and Measurement Equipment
- Breaking Ground Loops

DESCRIPTION

The LTM[®]2883 is a complete galvanic 6-channel digital μModule[®] (micromodule) isolator. No external components are required. A single 3.3V or 5V supply powers both sides of the interface through an integrated, isolated DC/DC converter. A logic supply pin allows easy interfacing with different logic levels from 1.62V to 5.5V, independent of the main supply.

Available options are compliant with SPI and I²C (master mode only) specifications.

The isolated side includes ±12.5V and 5V nominal power supplies, each capable of providing more than 20mA of load current. Each supply may be adjusted from its nominal value using a single external resistor.

Coupled inductors and an isolation power transformer provide 2500V_{RMS} of isolation between the input and output logic interface. This device is ideal for systems where the ground loop is broken, allowing for a large common mode voltage range. Communication is uninterrupted for common mode transients greater than 30kV/μs.

LT, LT, LTC, LTM, Linear Technology, the Linear logo and μModule are registered trademarks and Easy Drive, Hot Swap, SoftSpan and TimerBlox are trademarks of Linear Technology Corporation. All other trademarks are the property of their respective owners.

TYPICAL APPLICATION

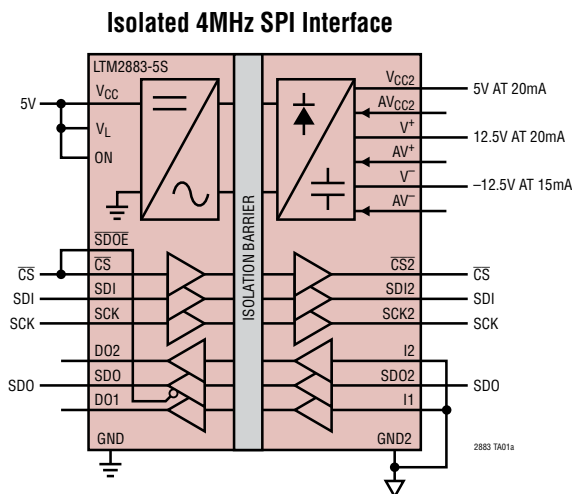

LTM2883 Operating Through 35kV/μs CM Transient

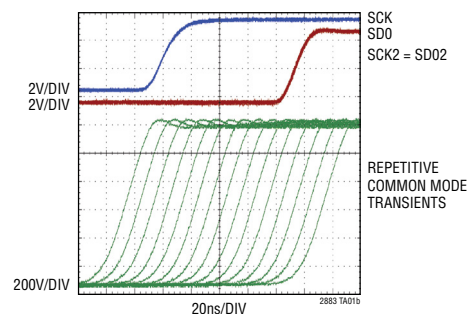

LTM2883

ABSOLUTE MAXIMUM RATINGS

(Note 1)

V_{CC} to GND	-0.3V to 6V
V_L to GND	-0.3V to 6V
V_{CC2} , AV_{CC2} , AV^+ to GND2	-0.3V to 6V
V^+ to GND2	-0.3V to 16V
V^- , AV^- to GND2	0.3V to -16V
Logic Inputs	
DI1, SCK, SDI, \overline{CS} , SCL, SDA, \overline{SDOE} , ON to GND	-0.3V to ($V_L + 0.3V$)
I1, I2, SDA2, SDO2 to GND2	-0.3V to ($V_{CC2} + 0.3V$)

Logic Outputs

DO1, DO2, SDO to GND	-0.3V to ($V_L + 0.3V$)
O1, SCK2, SDI2, $\overline{CS2}$, SCL2 to GND2	-0.3V to ($V_{CC2} + 0.3V$)

Operating Temperature Range (Note 4)

LTM2883C	$0^\circ\text{C} \leq T_A \leq 70^\circ\text{C}$
LTM2883I	$-40^\circ\text{C} \leq T_A \leq 85^\circ\text{C}$

Maximum Internal Operating Temperature..... 105°C

Storage Temperature Range -40°C to 105°C

Peak Body Reflow Temperature 245°C

PIN CONFIGURATION

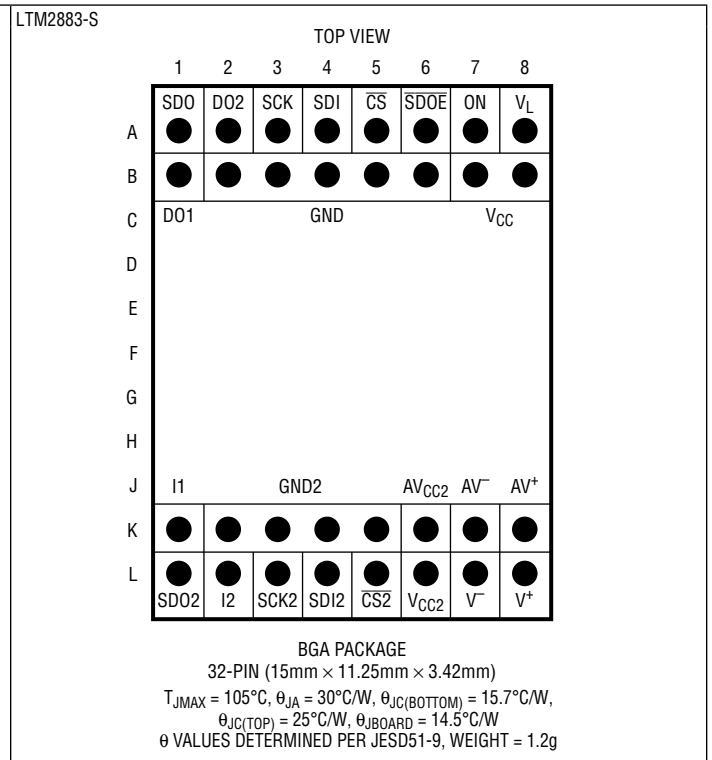
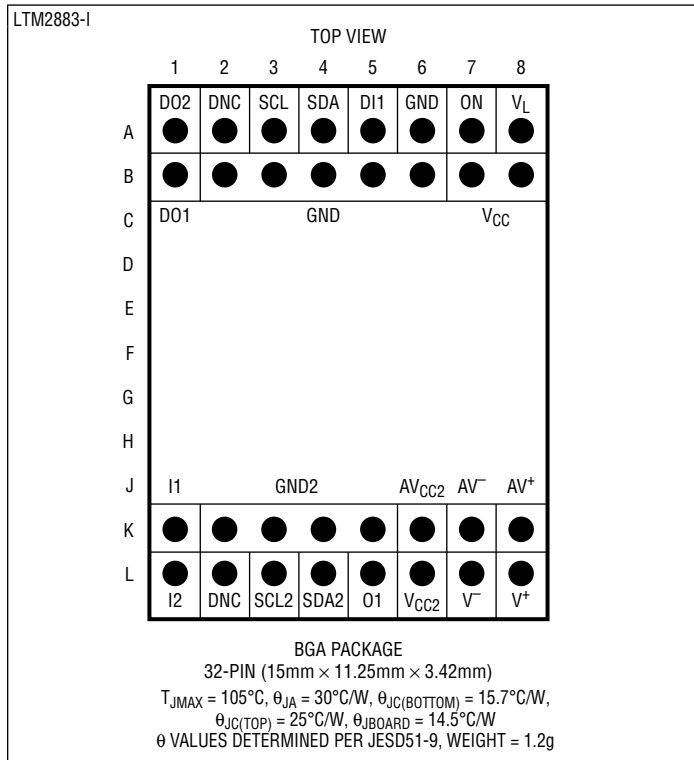

ORDER INFORMATION

PART NUMBER	INPUT VOLTAGE	PAD OR BALL FINISH	PART MARKING		PACKAGE TYPE	MSL RATING	TEMPERATURE RANGE
			DEVICE	FINISH CODE			
LTM2883CY-3S#PBF	3V TO 3.6V	SAC305 (RoHS)	LTM2883Y-3S	e1	BGA	4	0°C TO 70°C
LTM2883IY-3S#PBF							-40°C TO 85°C
LTM2883HY-3S#PBF (OBSOLETE)							-40°C TO 105°C
LTM2883CY-5S#PBF	4.5V TO 5.5V		LTM2883Y-5S				0°C TO 70°C
LTM2883IY-5S#PBF							-40°C TO 85°C
LTM2883HY-5S#PBF (OBSOLETE)							-40°C TO 105°C
LTM2883CY-3I#PBF	3V TO 3.6V		LTM2883Y-3I				0°C TO 70°C
LTM2883IY-3I#PBF							-40°C TO 85°C
LTM2883HY-3I#PBF (OBSOLETE)							-40°C TO 105°C
LTM2883CY-5I#PBF	4.5V TO 5.5V		LTM2883Y-5I				0°C TO 70°C
LTM2883IY-5I#PBF							-40°C TO 85°C
LTM2883HY-5I#PBF (OBSOLETE)							-40°C TO 105°C

- Device temperature grade is indicated by a label on the shipping container.
- Pad or ball finish code is per IPC/JEDEC J-STD-609.
- Terminal Finish Part Marking: www.linear.com/leadfree
- This product is not recommended for second side reflow. For more information, go to: www.linear.com/BGA-assy

- Recommended BGA PCB Assembly and Manufacturing Procedures: www.linear.com/BGA-assy
- BGA Package and Tray Drawings: www.linear.com/packaging
- This product is moisture sensitive. For more information, go to: www.linear.com/BGA-assy

ELECTRICAL CHARACTERISTICS

The ● denotes the specifications which apply over the full operating temperature range, otherwise specifications are at $T_A = 25^\circ\text{C}$. LTM2883-3 $V_{CC} = 3.3\text{V}$, LTM2883-5 $V_{CC} = 5\text{V}$, $V_L = 3.3\text{V}$, and $\text{GND} = \text{GND2} = 0\text{V}$, $\text{ON} = V_L$ unless otherwise noted. Specifications apply to all options unless otherwise noted.

SYMBOL	PARAMETER	CONDITIONS	MIN	TYP	MAX	UNITS	
Input Supplies							
V_{CC}	Input Supply Range	LTM2883-3	●	3	3.3	3.6	V
		LTM2883-5	●	4.5	5	5.5	V
V_L	Logic Supply Range	LTM2883-S	●	1.62		5.5	V
		LTM2883-I	●	3	5	5.5	V
I_{CC}	Input Supply Current	ON = 0V	●		0	10	μA
		LTM2883-3, ON = V_L , No Load	●		25	35	mA
		LTM2883-5, ON = V_L , No Load	●		19	28	mA
I_L	Logic Supply Current	ON = 0V	●		0	10	μA
		LTM2883-S, ON = V_L			10		μA
		LTM2883-I, ON = V_L				150	μA

ELECTRICAL CHARACTERISTICS The ● denotes the specifications which apply over the full operating temperature range, otherwise specifications are at $T_A = 25^\circ\text{C}$. LTM2883-3 $V_{CC} = 3.3\text{V}$, LTM2883-5 $V_{CC} = 5\text{V}$, $V_L = 3.3\text{V}$, and $\text{GND} = \text{GND2} = 0\text{V}$, $\text{ON} = V_L$ unless otherwise noted. Specifications apply to all options unless otherwise noted.

SYMBOL	PARAMETER	CONDITIONS	MIN	TYP	MAX	UNITS	
Output Supplies							
V_{CC2}	Regulated Output Voltage	No Load	● 4.75	5	5.25	V	
	Output Voltage Operating Range	(Note 2)	3		5.5	V	
	Line Regulation	$I_{LOAD} = 1\text{mA}$, $\text{MIN} \leq V_{CC} \leq \text{MAX}$	●	25	100	mV	
	Load Regulation	$I_{LOAD} = 100\mu\text{A}$ to 20mA	●	8	80	mV	
	ADJ Pin Voltage	$I_{LOAD} = 100\mu\text{A}$ to 20mA	●	585	600	615	mV
	Voltage Ripple	$I_{LOAD} = 20\text{mA}$ (Note 2)			1	mV _{RMS}	
	Efficiency	$I_{LOAD} = 20\text{mA}$ (Note 2)			45	%	
I_{CC2}	Output Short Circuit Current	$V_{CC2} = 0\text{V}$		45		mA	
	Current Limit	$\Delta V_{CC2} = -5\%$	● 20			mA	
V^+	Regulated Output Voltage	No Load	● 12	12.5	13	V	
	Line Regulation	$I_{LOAD} = 1\text{mA}$, $\text{MIN} \leq V_{CC} \leq \text{MAX}$	●	5	30	mV	
	Load Regulation	$I_{LOAD} = 100\mu\text{A}$ to 20mA	●		200	mV	
	ADJ Pin Voltage	$I_{LOAD} = 100\mu\text{A}$ to 20mA	●	1.170	1.220	1.260	mV
	Voltage Ripple	$I_{LOAD} = 20\text{mA}$ (Note 2)			3	mV _{RMS}	
	Efficiency	$I_{LOAD} = 20\text{mA}$ (Note 2)			45	%	
I^+	Output Short Circuit Current	$V^+ = 0\text{V}$		70		mA	
	Current Limit	$\Delta V^+ = -0.5\text{V}$	● 20			mA	
V^-	Regulated Output Voltage	No Load	● -12	-12.5	-13	V	
	Line Regulation	$I_{LOAD} = -1\text{mA}$, $\text{MIN} \leq V_{CC} \leq \text{MAX}$	●	4	15	mV	
	Load Regulation	$I_{LOAD} = 100\mu\text{A}$ to 15mA , $V^+_{LOAD} = 1.5\text{mA}$			35	mV	
	ADJ Pin Voltage	$I_{LOAD} = 100\mu\text{A}$ to 15mA , $V^+_{LOAD} = 1.5\text{mA}$	●	-1.184	-1.220	-1.256	mV
	Voltage Ripple	$I_{LOAD} = 15\text{mA}$, $V^+_{LOAD} = 1.5\text{mA}$ (Note 2)			2	mV _{RMS}	
	Efficiency	$I_{LOAD} = 15\text{mA}$ (Note 2)			45	%	
I^-	Output Short-Circuit Current	$V^- = 0\text{V}$		30		mA	
	Current Limit	$\Delta V^- = 0.5\text{V}$, $V^+ = 1.5\text{mA}$	● 10	15		mA	
Logic/SPI							
V_{ITH}	Input Threshold Voltage	ON, DI1, SDOE, SCK, SDI, CS $1.62\text{V} \leq V_L < 2.35\text{V}$	● $0.25 \cdot V_L$		$0.75 \cdot V_L$	V	
		ON, DI1, SDOE, SCK, SDI, CS $2.35\text{V} \leq V_L$	● $0.33 \cdot V_L$		$0.67 \cdot V_L$	V	
		I1, I2, SDO2	● $0.33 \cdot V_{CC2}$		$0.67 \cdot V_{CC2}$	V	
I_{INL}	Input Current				±1	μA	
V_{HYS}	Input Hysteresis	(Note 2)		150		mV	
V_{OH}	Output High Voltage	DO1, DO2, SDO $I_{LOAD} = -1\text{mA}$, $1.62\text{V} \leq V_L < 3\text{V}$ $I_{LOAD} = -4\text{mA}$, $3\text{V} \leq V_L \leq 5.5\text{V}$	● $V_L - 0.4$			V	
		O1, SCK2, SDI2, CS2, $I_{LOAD} = -4\text{mA}$	● $V_{CC2} - 0.4$			V	
V_{OL}	Output Low Voltage	DO1, DO2, SDO $I_{LOAD} = 1\text{mA}$, $1.62\text{V} \leq V_L < 3\text{V}$ $I_{LOAD} = 4\text{mA}$, $3\text{V} \leq V_L \leq 5.5\text{V}$	●		0.4	V	
		O1, SCK2, SDI2, CS2, $I_{LOAD} = 4\text{mA}$	●		0.4	V	
I_{SC}	Short-Circuit Current	$0\text{V} \leq (\text{DO1, DO2, SDO}) \leq V_L$	●		±85	mA	
		$0\text{V} \leq (\text{O1, SCK2, SDI2, CS2}) \leq V_{CC2}$		±60		mA	

ELECTRICAL CHARACTERISTICS The ● denotes the specifications which apply over the full operating temperature range, otherwise specifications are at $T_A = 25^\circ\text{C}$. LTM2883-3 $V_{CC} = 3.3\text{V}$, LTM2883-5 $V_{CC} = 5\text{V}$, $V_L = 3.3\text{V}$, and $\text{GND} = \text{GND2} = 0\text{V}$, $\text{ON} = V_L$ unless otherwise noted. Specifications apply to all options unless otherwise noted.

SYMBOL	PARAMETER	CONDITIONS	MIN	TYP	MAX	UNITS
I²C						
V_{IL}	Low Level Input Voltage	SCL, SDA SDA2	●		$0.3 \cdot V_L$ $0.3 \cdot V_{CC2}$	V V
V_{IH}	High Level Input Voltage	SCL, SDA SDA2	●	$0.7 \cdot V_L$ $0.7 \cdot V_{CC2}$		V V
I_{INL}	Input Current	SCL, SDA = V_L or 0V	●		± 1	μA
V_{HYS}	Input Hysteresis	SCL, SDA SDA2		$0.05 \cdot V_L$ $0.05 \cdot V_{CC2}$		mV mV
V_{OH}	Output High Voltage	SCL2, $I_{LOAD} = -2\text{mA}$ DO2, $I_{LOAD} = -2\text{mA}$	●	$V_{CC2} - 0.4$ $V_L - 0.4$		V V
V_{OL}	Output Low Voltage	SDA, $V_L = 3\text{V}$, $I_{LOAD} = 3\text{mA}$ DO2, $V_L = 3\text{V}$, $I_{LOAD} = 2\text{mA}$ SCL2, $I_{LOAD} = 2\text{mA}$ SDA2, No Load, SDA = 0V, $4.5\text{V} \leq V_{CC2} < 5.5\text{V}$ SDA2, No Load, SDA = 0V, $3\text{V} < V_{CC2} < 4.5\text{V}$	●		0.4 0.4 0.4 0.45 0.55	V V V V V
C_{IN}	Input Pin Capacitance	SCL, SDA, SDA2 (Note 2)	●		10	pF
C_B	Bus Capacitive Load	SCL2, Standard Speed (Note 2) SCL2, Fast Speed SDA, SDA2, SR $\geq 1\text{V}/\mu\text{s}$, Standard Speed (Note 2) SDA, SDA2, SR $\geq 1\text{V}/\mu\text{s}$, Fast Speed	●		400 200 400 200	pF pF pF pF
	Minimum Bus Slew Rate	SDA, SDA2	●	1		V/ μs
I_{SC}	Short-Circuit Current	SDA2 = 0, SDA = V_L $0\text{V} \leq \text{SCL2} \leq V_{CC2}$ $0\text{V} \leq \text{DO2} \leq V_L$ SDA = 0, SDA2 = V_{CC2} SDA = V_L , SDA2 = 0	●	± 30 ± 30 6 -1.8	100	mA mA mA mA
ESD (HBM) (Note 2)						
	Isolation Boundary	(V_{CC2} , V^+ , V^- , GND2) to (V_{CC} , V_L , GND)			± 10	kV

SWITCHING CHARACTERISTICS The ● denotes the specifications which apply over the full operating temperature range, otherwise specifications are at $T_A = 25^\circ\text{C}$. LTM2883-3 $V_{CC} = 3.3\text{V}$, LTM2883-5 $V_{CC} = 5\text{V}$, $V_L = 3.3\text{V}$, and $\text{GND} = \text{GND2} = 0\text{V}$, $\text{ON} = V_L$ unless otherwise noted. Specifications apply to all options unless otherwise noted.

SYMBOL	PARAMETER	CONDITIONS	MIN	TYP	MAX	UNITS	
Logic							
	Maximum Data Rate	$I_x \rightarrow \text{DO}_x$, $C_L = 15\text{pF}$ (Note 3)	●	10		MHz	
t_{PHL} , t_{PLH}	Propagation Delay	$C_L = 15\text{pF}$ (Figure 1)	●	35	60	100	ns
t_R	Rise Time	$C_L = 15\text{pF}$ (Figure 1) LTM2883-I, DO2, $C_L = 15\text{pF}$ (Figure 1)	●		3 20	12.5 35	ns ns
t_F	Fall Time	$C_L = 15\text{pF}$ (Figure 1) LTM2883-I, DO2, $C_L = 15\text{pF}$ (Figure 1)	●		3 20	12.5 35	ns ns
SPI							
	Maximum Data Rate	Bidirectional Communication (Note 3) Unidirectional Communication (Note 3)	●	4 8		MHz MHz	
t_{PHL} , t_{PLH}	Propagation Delay	$C_L = 15\text{pF}$ (Figure 1)	●	35	60	100	ns
t_{PWU}	Output Pulse Width Uncertainty	SDI2, $\overline{\text{CS}}_2$ (Note 2)		-20		50	ns

SWITCHING CHARACTERISTICS

The ● denotes the specifications which apply over the full operating temperature range, otherwise specifications are at $T_A = 25^\circ\text{C}$. LTM2883-3 $V_{CC} = 3.3\text{V}$, LTM2883-5 $V_{CC} = 5\text{V}$, $V_L = 3.3\text{V}$, and $\text{GND} = \text{GND2} = 0\text{V}$, $\text{ON} = V_L$ unless otherwise noted. Specifications apply to all options unless otherwise noted.

SYMBOL	PARAMETER	CONDITIONS	MIN	TYP	MAX	UNITS
t_R	Rise Time	$C_L = 15\text{pF}$ (Figure 1) ●		3	12.5	ns
t_F	Fall Time	$C_L = 15\text{pF}$ (Figure 1) ●		3	12.5	ns
t_{PZH}, t_{PZL}	Output Enable Time	$\overline{\text{SDOE}} = \downarrow, R_L = 1\text{k}\Omega, C_L = 15\text{pF}$ (Figure 2) ●			50	ns
t_{PHZ}, t_{PLZ}	Output Disable Time	$\overline{\text{SDOE}} = \uparrow, R_L = 1\text{k}\Omega, C_L = 15\text{pF}$ (Figure 2) ●			50	ns

i^2C						
	Maximum Data Rate	(Note 3) ●	400			kHz
t_{PHL}, t_{PLH}	Propagation Delay	SCL \rightarrow SCL2, $C_L = 15\text{pF}$ (Figure 1) ●		150	225	ns
		SDA \rightarrow SDA2, $R_L = \text{Open}, C_L = 15\text{pF}$ (Figure 3) ●		150	250	ns
		SDA2 \rightarrow SDA, $R_L = 1.1\text{k}\Omega, C_L = 15\text{pF}$ (Figure 3) ●		200	350	ns
t_{PWU}	Output Pulse Width Uncertainty	SDA, SDA2 (Note 2)	-20		50	ns
$t_{HD, DAT}$	Data Hold Time	(Note 2)		600		ns
t_R	Rise Time	SDA2, $C_L = 200\text{pF}$ (Figure 3) ●	40		250	ns
		SDA2, $C_L = 200\text{pF}$ (Figure 3) ●	40		300	ns
		SDA, $R_L = 1.1\text{k}\Omega, C_L = 200\text{pF}$ (Figure 3) ●	40		250	ns
		SCL2, $C_L = 200\text{pF}$ (Figure 1) ●			250	ns
t_F	Fall Time	SDA2, $C_L = 200\text{pF}$ (Figure 3) ●	40		250	ns
		SDA, $R_L = 1.1\text{k}\Omega, C_L = 200\text{pF}$ (Figure 3) ●	40		250	ns
		SCL2, $C_L = 200\text{pF}$ (Figure 1) ●			250	ns
t_{SP}	Pulse Width of Spikes Suppressed by Input Filter	●	0		50	ns

Power Supply

	Power-Up Time	ON = \uparrow to V_{CC2} (Min) ●		0.6	2	ms
		ON = \uparrow to V^+ (Min) ●		0.6	2	ms
		ON = \uparrow to V^- (Min) ●		0.6	2.5	ms

ISOLATION CHARACTERISTICS $T_A = 25^\circ\text{C}$.

SYMBOL	PARAMETER	CONDITIONS	MIN	TYP	MAX	UNITS
V_{ISO}	Rated Dielectric Insulation Voltage (Notes 5, 6, 7)	1 Minute, Derived from 1 Second Test	2500			V_{RMS}
		1 Second	± 4400			V
	Common Mode Transient Immunity	LTM2883-3 $V_{CC} = 3.3\text{V}$, LTM2883-5 $V_{CC} = 5\text{V}$, $V_L = \text{ON} = 3.3\text{V}$, $V_{CM} = 1\text{kV}$, $\Delta t = 33\text{ns}$ (Note 2)	30			$\text{kV}/\mu\text{s}$
V_{IORM}	Maximum Continuous Working Voltage	(Notes 2, 5)	560			V_{PEAK}
			400			V_{RMS}
	Partial Discharge	$V_{PD} = 1050V_{PEAK}$ (Notes 2, 5)			5	pC
CTI	Comparative Tracking Index	IEC 60112 (Note 2)	600			V_{RMS}
		Depth of Erosion	IEC 60112 (Note 2)		0.017	
DTI	Distance Through Insulation	(Note 2)		0.06		mm
		Input to Output Resistance	(Notes 2, 5)	10^9		
	Input to Output Capacitance	(Notes 2, 5)		6		pF
	Creepage Distance	(Note 2)		9.48		mm

ISOLATION CHARACTERISTICS

Note 1: Stresses beyond those listed under Absolute Maximum Ratings may cause permanent damage to the device. Exposure to any Absolute Maximum Rating condition for extended periods may affect device reliability and lifetime.

Note 2: Guaranteed by design and not subject to production test.

Note 3: Maximum data rate is guaranteed by other measured parameters and is not tested directly.

Note 4: This module includes overtemperature protection that is intended to protect the device during momentary overload conditions. Junction temperature will exceed 105°C when overtemperature protection is active.

Continuous operation above specified maximum operating junction temperature may result in device degradation or failure.

Note 5: Device considered a 2-terminal device. Pin group A1 through B8 shorted together and pin group K1 through L8 shorted together.

Note 6: The rated dielectric insulation voltage should not be interpreted as a continuous voltage rating.

Note 7: In accordance with UL1577, each device is proof tested for the 2500V_{RMS} rating by applying the equivalent positive and negative peak voltage multiplied by an acceleration factor of 1.2 for one second.

LTM2883

TYPICAL PERFORMANCE CHARACTERISTICS $T_A = 25^\circ\text{C}$, LTM2883-3 $V_{CC} = 3.3\text{V}$, LTM2883-5 $V_{CC} = 5\text{V}$, $V_L = 3.3\text{V}$, $\text{GND} = \text{GND2} = 0\text{V}$, $\text{ON} = V_L$ unless otherwise noted.

V_{CC} Supply Current vs Temperature

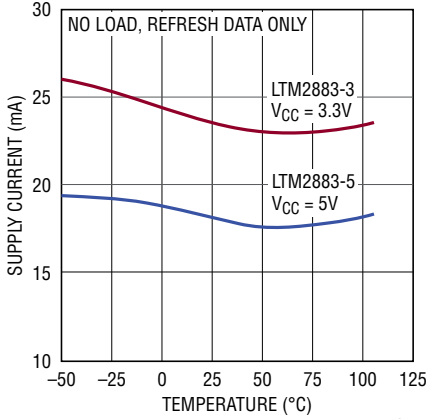

Isolated Supplies vs Equal Load Current

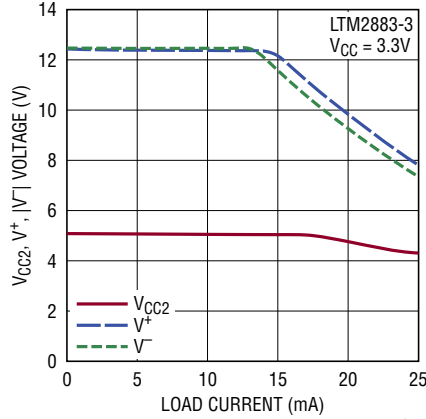

Isolated Supplies vs Equal Load Current

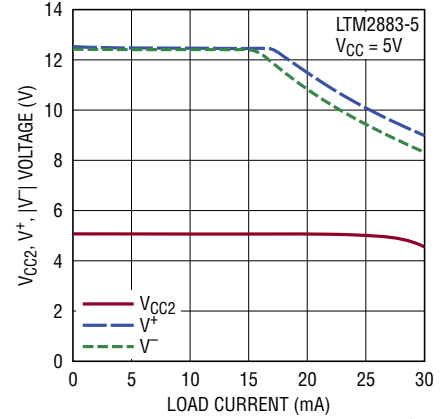

V_{CC2} Line Regulation vs Load Current

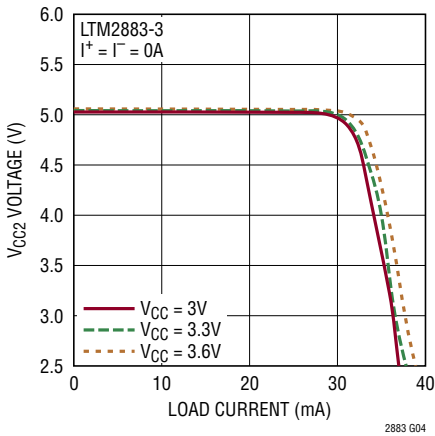

V^+ Line Regulation vs Load Current

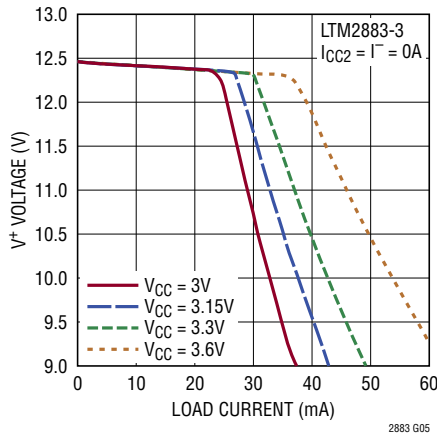

V^- Line Regulation vs Load Current

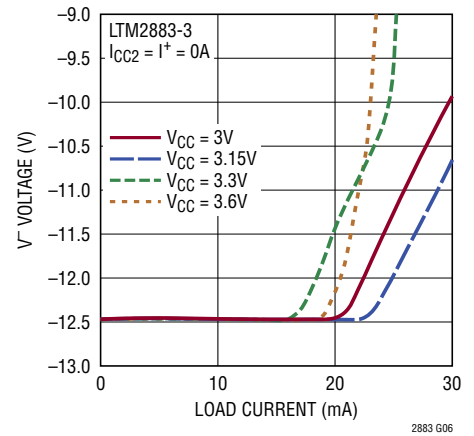

V_{CC2} Line Regulation vs Load Current

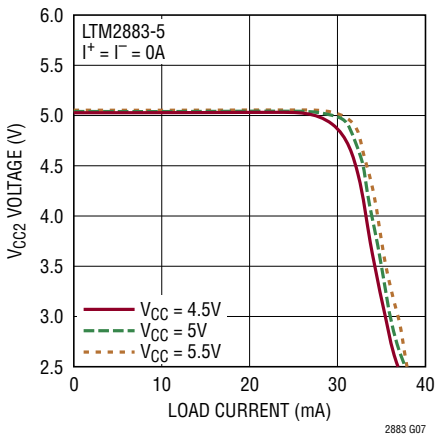

V^+ Line Regulation vs Load Current

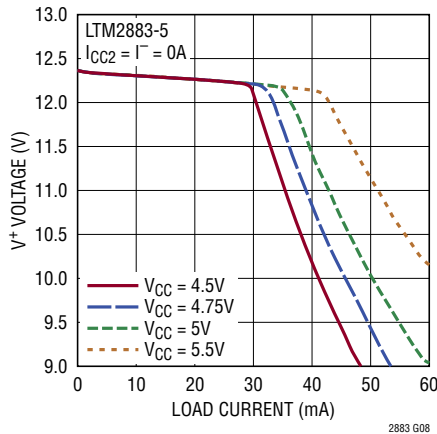

V^- Line Regulation vs Load Current

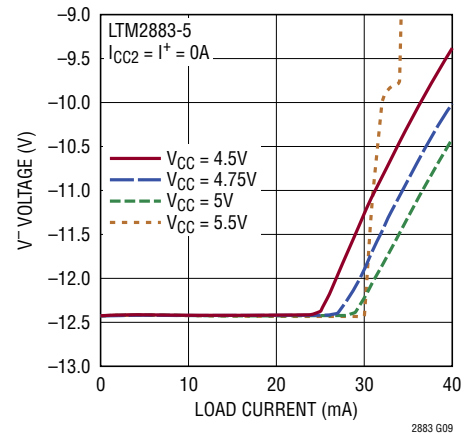

TYPICAL PERFORMANCE CHARACTERISTICS $T_A = 25^\circ\text{C}$, LTM2883-3 $V_{CC} = 3.3\text{V}$, LTM2883-5 $V_{CC} = 5\text{V}$, $V_L = 3.3\text{V}$, $\text{GND} = \text{GND2} = 0\text{V}$, $\text{ON} = V_L$ unless otherwise noted.

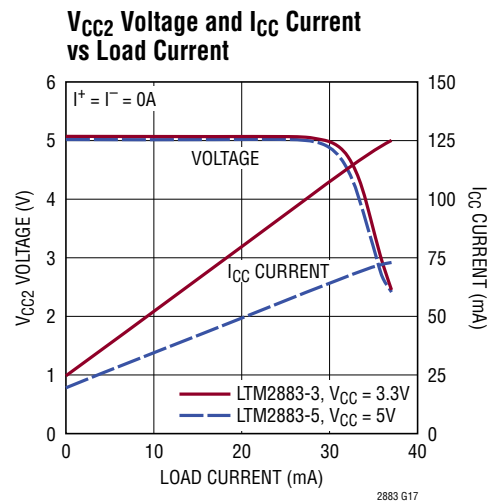
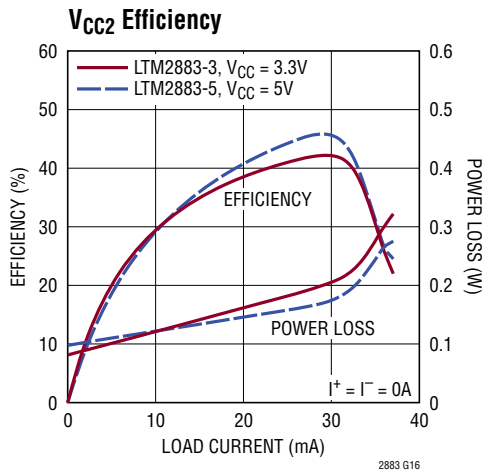
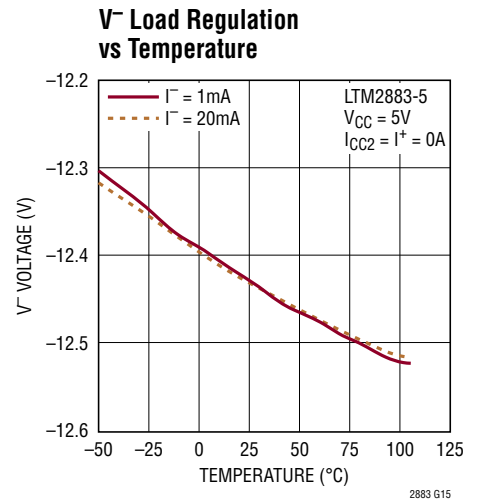
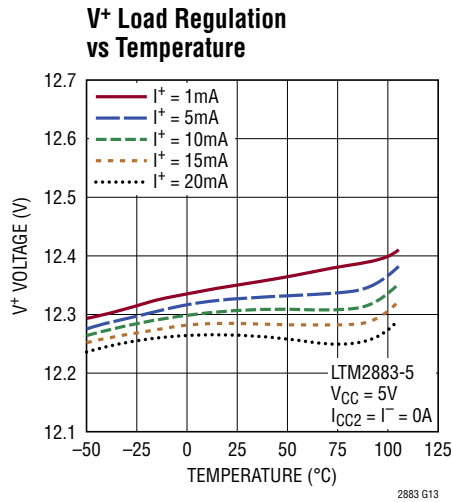
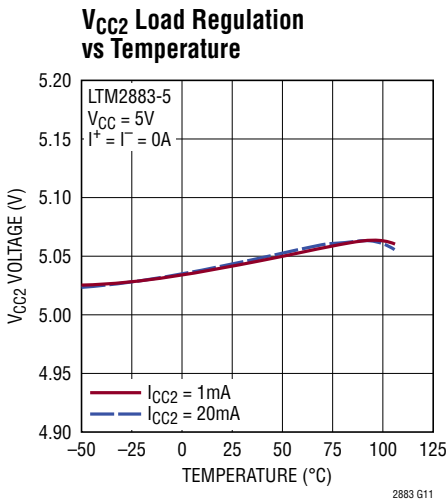
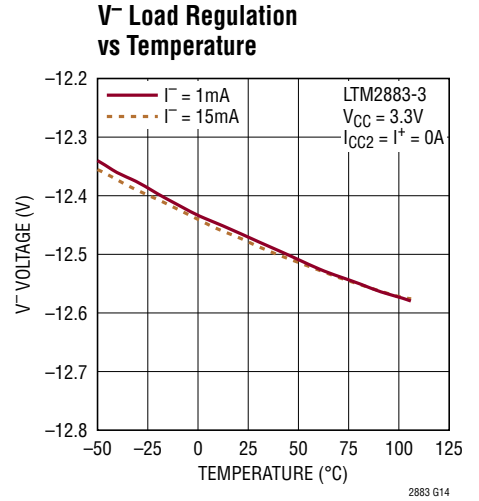
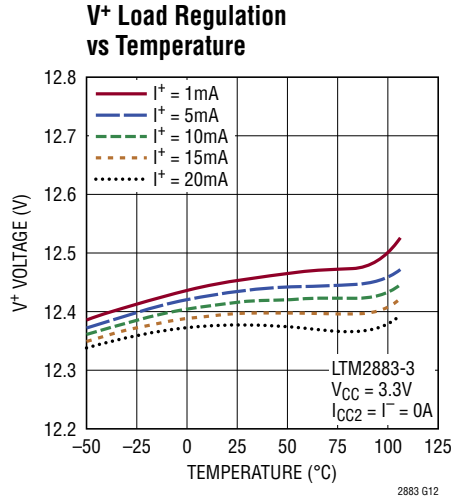
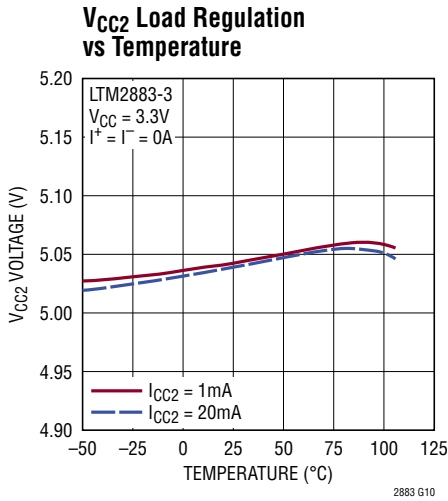

TYPICAL PERFORMANCE CHARACTERISTICS $T_A = 25^\circ\text{C}$, LTM2883-3 $V_{CC} = 3.3\text{V}$, LTM2883-5 $V_{CC} = 5\text{V}$, $V_L = 3.3\text{V}$, $\text{GND} = \text{GND2} = 0\text{V}$, $\text{ON} = V_L$ unless otherwise noted.

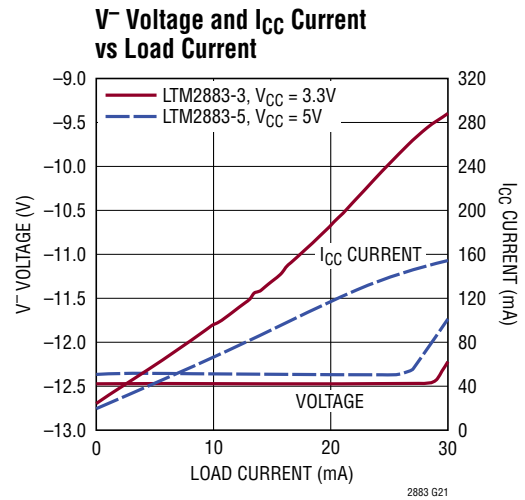
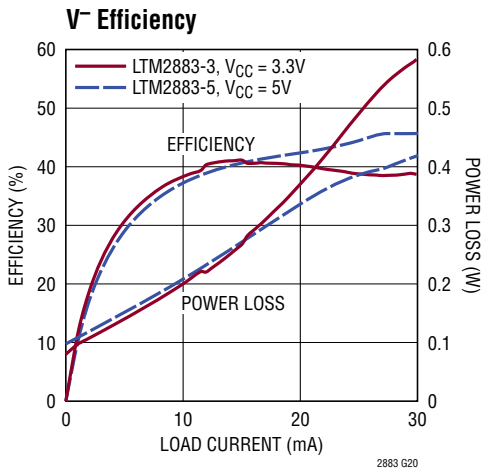
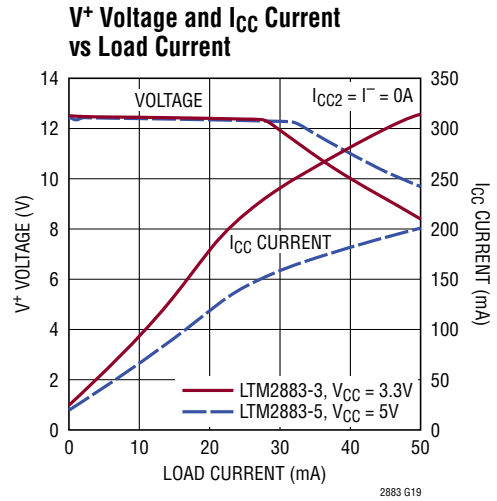
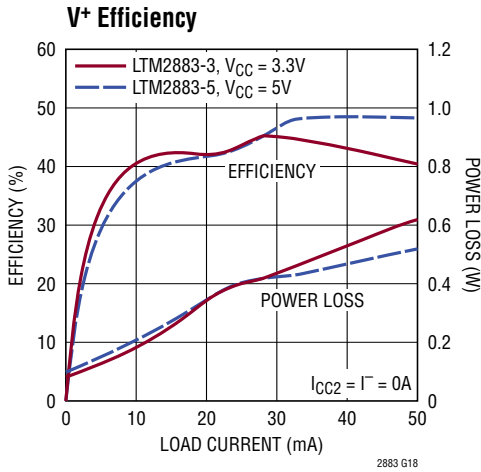

V_{CC2} Transient Response
20mA Load Step

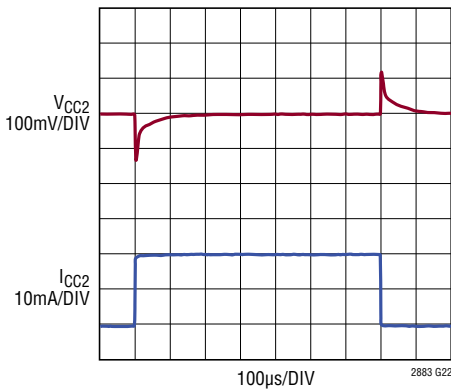

V+ Transient Response
20mA Load Step

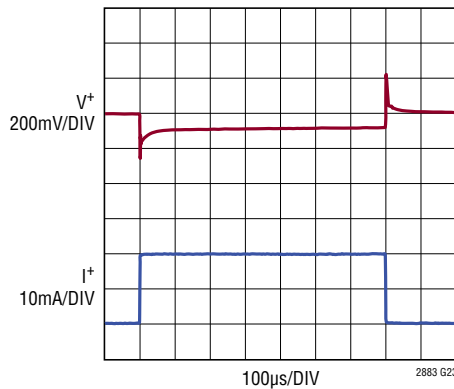

V- Transient Response
20mA Load Step

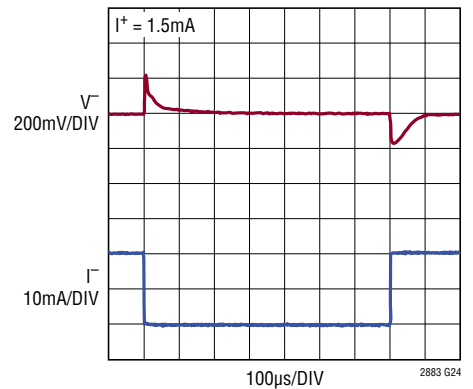

TYPICAL PERFORMANCE CHARACTERISTICS $T_A = 25^\circ\text{C}$, LTM2883-3 $V_{CC} = 3.3\text{V}$,
 LTM2883-5 $V_{CC} = 5\text{V}$, $V_L = 3.3\text{V}$, $\text{GND} = \text{GND2} = 0\text{V}$, $\text{ON} = V_L$ unless otherwise noted.

V_{CC2} Ripple

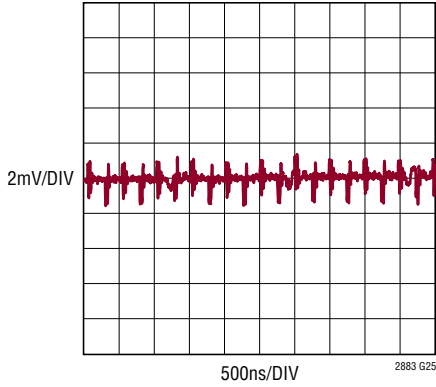

V^+ Ripple

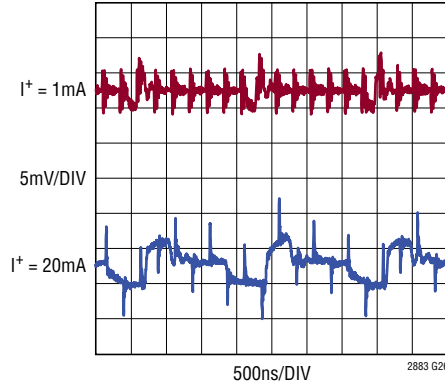

V^- Ripple

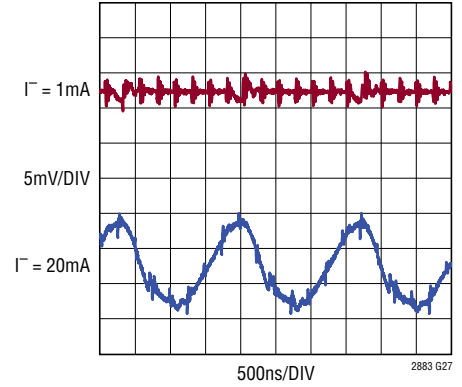

V_{CC2} Noise

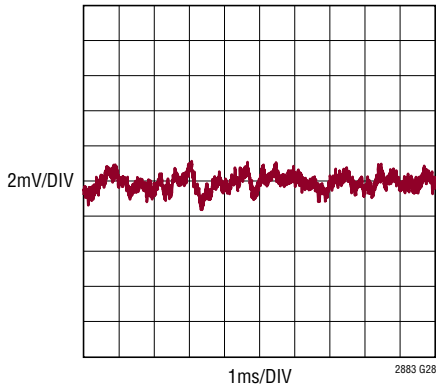

V^+ Noise

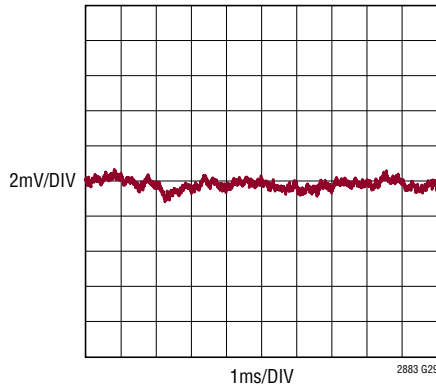

V^- Noise

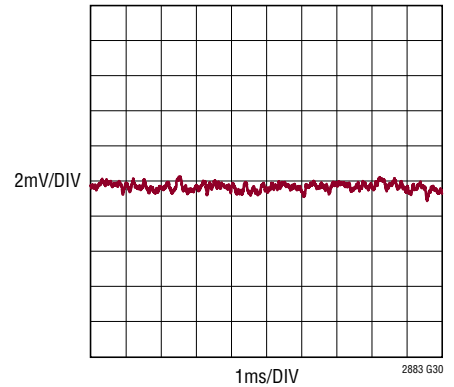

V_{CC} Supply Current vs Single Channel Data Rate

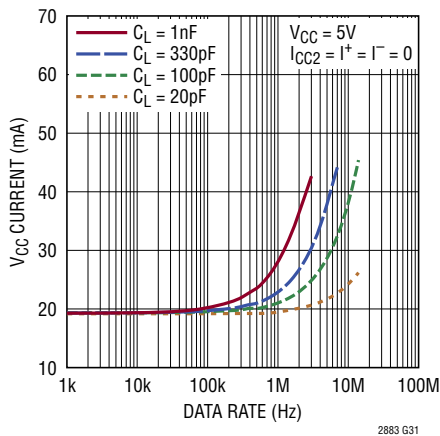

Logic Input Threshold vs V_L Supply Voltage

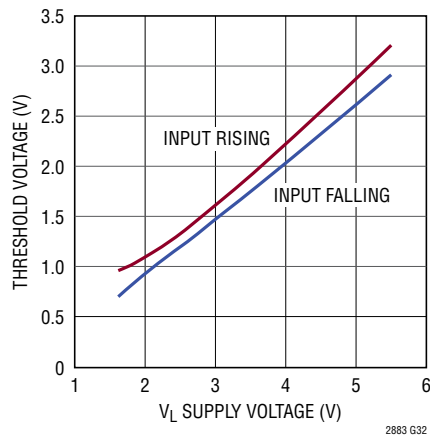

Logic Output Voltage vs Load Current

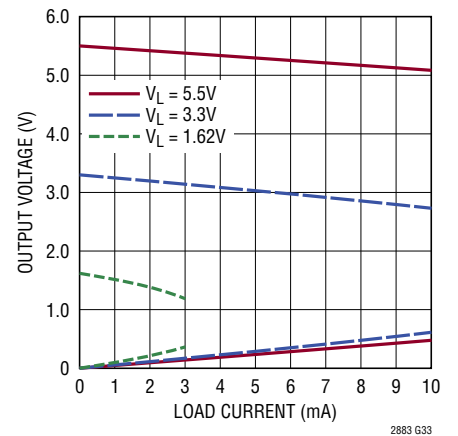

TYPICAL PERFORMANCE CHARACTERISTICS $T_A = 25^\circ\text{C}$, LTM2883-3 $V_{CC} = 3.3\text{V}$, LTM2883-5 $V_{CC} = 5\text{V}$, $V_L = 3.3\text{V}$, $\text{GND} = \text{GND}2 = 0\text{V}$, $\text{ON} = V_L$ unless otherwise noted.

Power On Sequence

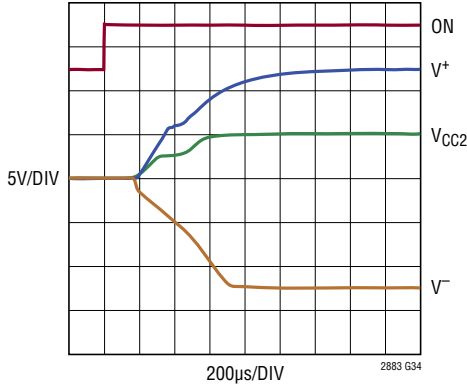

V_{CC2} Cross Regulation vs V^+ , V^- Load

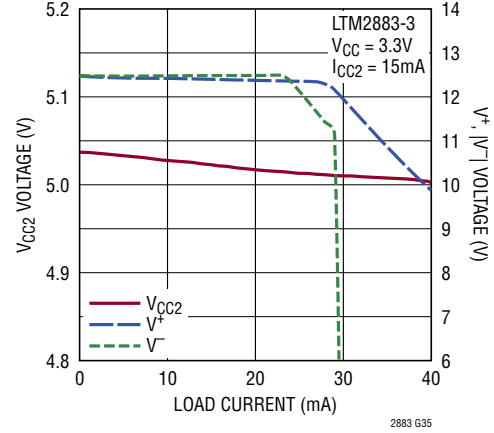

V_{CC2} Cross Regulation vs V^+ , V^- Load

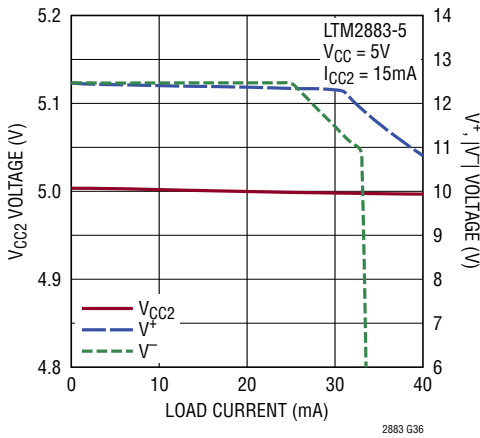

Isolated Supply Efficiency with Equal Load Current

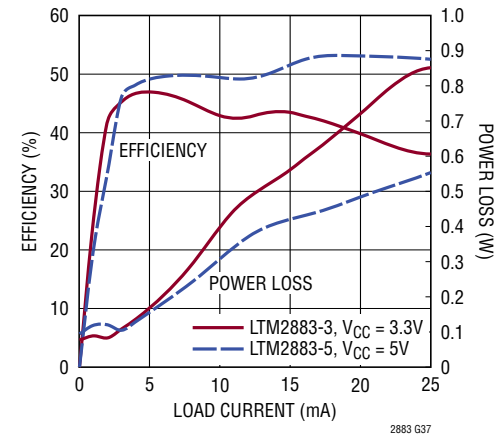

V^+ Cross Regulation vs V^- Load

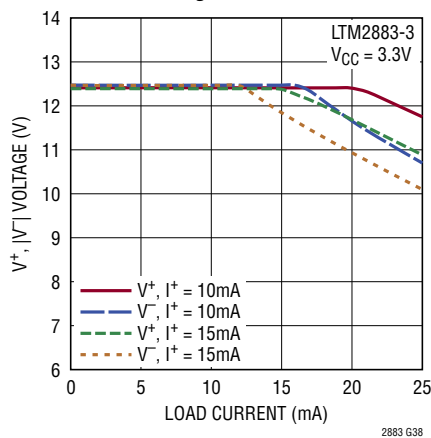

V^+ Cross Regulation vs V^- Load

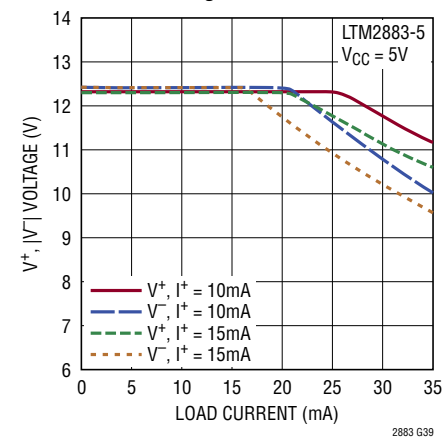

PIN FUNCTIONS (LTM2883-1)

Logic Side

DO2 (A1): Digital Output, Referenced to V_L and GND. Logic output connected to I2 through isolation barrier. Under the condition of an isolation communication failure this output is in a high impedance state.

DNC (A2): Do Not Connect Pin. Pin connected internally.

SCL (A3): Serial I²C Clock Input, Referenced to V_L and GND. Logic input connected to isolated side SCL2 pin through isolation barrier. Clock is unidirectional from logic to isolated side. Do not float.

SDA (A4): Serial I²C Data Pin, Referenced to V_L and GND. Bidirectional logic pin connected to isolated side SDA2 pin through isolation barrier. Under the condition of an isolation communication failure this pin is in a high impedance state. Do not float.

DI1 (A5): Digital Input, Referenced to V_L and GND. Logic input connected to O1 through isolation barrier. The logic state on DI1 translates to the same logic state on O1. Do not float.

GND (A6, B2 to B6): Circuit Ground.

ON (A7): Enable. Enables power and data communication through the isolation barrier. If ON is high the part is enabled and power and communications are functional to the isolated side. If ON is low the logic side is held in reset, all digital outputs are in a high impedance state, and the isolated side is unpowered. Do not float.

V_L (A8): Logic Supply. Interface supply voltage for pins DI1, SCL, SDA, DO1, DO2, and ON. Operating voltage is 3V to 5.5V. Internally bypassed with 2.2 μ F.

DO1 (B1): Digital Output, Referenced to V_L and GND. Logic output connected to I1 through isolation barrier. Under the condition of an isolation communication failure this output is in a high impedance state.

V_{CC} (B7 to B8): Supply Voltage. Operating voltage is 3V to 3.6V for LTM2883-3 and 4.5V to 5.5V for LTM2883-5. Internally bypassed with 2.2 μ F.

Isolated Side

I2 (L1): Digital Input, Referenced to V_{CC2} and GND2. Logic input connected to DO2 through isolation barrier.

The logic state on I2 translates to the same logic state on DO2. Do not float.

DNC (L2): Do Not Connect Pin. Pin connected internally.

SCL2 (L3): Serial I²C Clock Output, Referenced to V_{CC2} and GND2. Logic output connected to logic side SCL pin through isolation barrier. Clock is unidirectional from logic to isolated side. SCL2 has a push-pull output stage, do not connect an external pull-up device. Under the condition of an isolation communication failure this output defaults to a high state.

SDA2 (L4): Serial I²C Data Pin, Referenced to V_{CC2} and GND2. Bidirectional logic pin connected to logic side SDA pin through isolation barrier. Output is biased high by a 1.8mA current source. Do not connect an external pull-up device to SDA2. Under the condition of an isolation communication failure this output defaults to a high state.

O1 (L5): Digital Output, Referenced to V_{CC2} and GND2. Logic output connected to DI1 through isolation barrier. Under the condition of an isolation communication failure O1 defaults to a high state.

V_{CC2} (L6): 5V Nominal Isolated Supply Voltage. Internally generated from V_{CC} by an isolated DC/DC converter and regulated to 5V. Internally bypassed with 2.2 μ F.

V^- (L7): -12.5V Nominal Isolated Supply Voltage. Internally generated from V_{CC} by an isolated DC/DC converter and regulated to -12.5V. Internally bypassed with 1 μ F.

V^+ (L8): 12.5V Nominal Isolated Supply Voltage. Internally generated from V_{CC} by an isolated DC/DC converter and regulated to 12.5V. Internally bypassed with 1 μ F.

I1 (K1): Digital Input, Referenced to V_{CC2} and GND2. Logic input connected to DO1 through isolation barrier. The logic state on I1 translates to the same logic state on DO1. Do not float.

GND2 (K2 to K5): Isolated Ground.

AV_{CC2} (K6): 5V Nominal Isolated Supply Voltage Adjust. The adjust pin voltage is 600mV referenced to GND2.

AV^- (K7): -12.5V Nominal Isolated Supply Voltage Adjust. The adjust pin voltage is -1.22V referenced to GND2.

AV^+ (K8): 12.5V Nominal Isolated Supply Voltage Adjust. The adjust pin voltage is 1.22V referenced to GND2.

PIN FUNCTIONS (LTM2883-S)

Logic Side

SDO (A1): Serial SPI Digital Output, Referenced to V_L and GND. Logic output connected to isolated side SDO2 pin through isolation barrier. Under the condition of an isolation communication failure this output is in a high impedance state.

DO2 (A2): Digital Output, Referenced to V_L and GND. Logic output connected to I2 through isolation barrier. Under the condition of an isolation communication failure this output is in a high impedance state.

SCK (A3): Serial SPI Clock Input, Referenced to V_L and GND. Logic input connected to isolated side SCK2 pin through isolation barrier. Do not float.

SDI (A4): Serial SPI Data Input, Referenced to V_L and GND. Logic input connected to isolated side SDI2 pin through isolation barrier. Do not float.

\overline{CS} (A5): Serial SPI Chip Select, Referenced to V_L and GND. Logic input connected to isolated side $\overline{CS2}$ pin through isolation barrier. Do not float.

\overline{SDOE} (A6): Serial SPI Data Output Enable, Referenced to V_L and GND. A logic high on \overline{SDOE} places the logic side SDO pin in a high impedance state, a logic low enables the output. Do not float.

ON (A7): Enable. Enables power and data communication through the isolation barrier. If ON is high the part is enabled and power and communications are functional to the isolated side. If ON is low the logic side is held in reset, all digital outputs are in a high impedance state, and the isolated side is unpowered. Do not float.

V_L (A8): Logic Supply. Interface supply voltage for pins SDI, SCK, SDO, DO1, DO2, \overline{CS} , and ON. Operating voltage is 1.62V to 5.5V. Internally bypassed with 2.2 μ F.

DO1 (B1): Digital Output, Referenced to V_L and GND. Logic output connected to I1 through isolation barrier. Under the condition of an isolation communication failure this output is in a high impedance state.

GND (B2 to B6): Circuit Ground.

V_{CC} (B7 to B8): Supply Voltage. Operating voltage is 3V to 3.6V for LTM2883-3 and 4.5V to 5.5V for LTM2883-5. Internally bypassed with 2.2 μ F.

Isolated Side

SDO2 (L1): Serial SPI Digital Input, Referenced to V_{CC2} and GND2. Logic input connected to logic side SDO pin through isolation barrier. Do not float.

I2 (L2): Digital Input, Referenced to V_{CC2} and GND2. Logic input connected to DO2 through isolation barrier. The logic state on I2 translates to the same logic state on DO2. Do not float.

SCK2 (L3): Serial SPI Clock Output, Referenced to V_{CC2} and GND2. Logic output connected to logic side SCK pin through isolation barrier. Under the condition of an isolation communication failure this output defaults to a low state.

SDI2 (L4): Serial SPI Data Output, Referenced to V_{CC2} and GND2. Logic output connected to logic side SDI pin through isolation barrier. Under the condition of an isolation communication failure this output defaults to a low state.

$\overline{CS2}$ (L5): Serial SPI Chip Select, Referenced to V_{CC2} and GND2. Logic output connected to logic side \overline{CS} pin through isolation barrier. Under the condition of an isolation communication failure this output defaults to a high state.

V_{CC2} (L6): 5V Nominal Isolated Supply Voltage. Internally generated from V_{CC} by an isolated DC/DC converter and regulated to 5V. Internally bypassed with 2.2 μ F.

V^- (L7): -12.5V Nominal Isolated Supply Voltage. Internally generated from V_{CC} by an isolated DC/DC converter and regulated to -12.5V. Internally bypassed with 1 μ F.

V^+ (L8): 12.5V Nominal Isolated Supply Voltage. Internally generated from V_{CC} by an isolated DC/DC converter and regulated to 12.5V. Internally bypassed with 1 μ F.

I1 (K1): Digital Input, Referenced to V_{CC2} and GND2. Logic input connected to DO1 through isolation barrier. The logic state on I1 translates to the same logic state on DO1. Do not float.

GND2 (K2 to K5): Isolated Ground.

AV_{CC2} (K6): 5V Nominal Isolated Supply Voltage Adjust. The adjust pin voltage is 600mV Referenced to GND2.

AV^- (K7): -12.5V Nominal Isolated Supply Voltage Adjust. The adjust pin voltage is -1.22V Referenced to GND2.

AV^+ (K8): 12.5V Nominal Isolated Supply Voltage Adjust. The adjust pin voltage is 1.22V Referenced to GND2.

BLOCK DIAGRAM

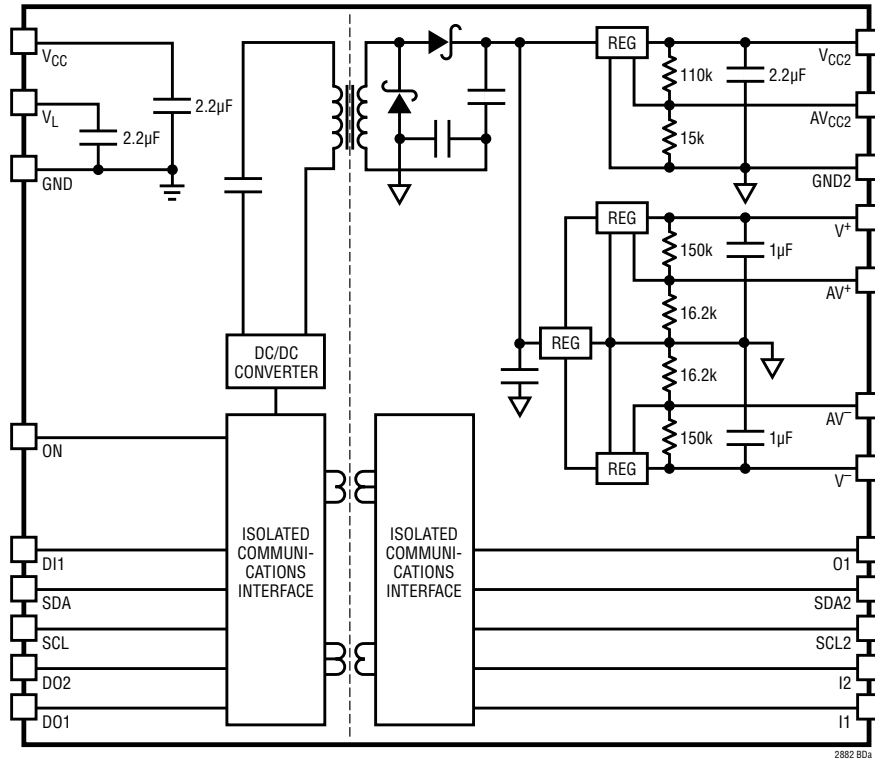

LTM2883-I

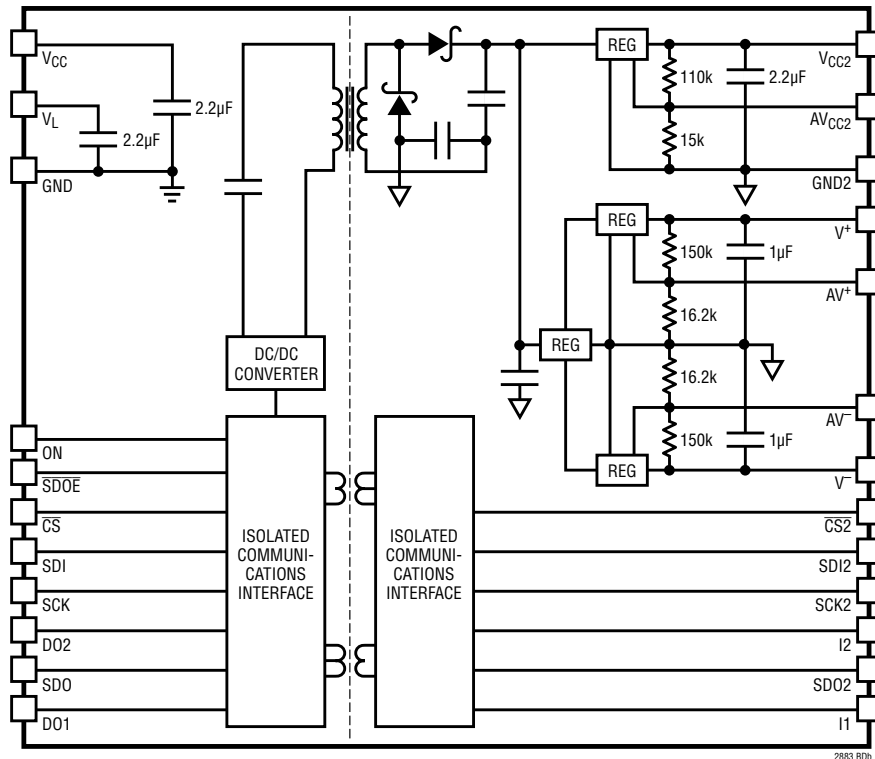

LTM2883-S

TEST CIRCUITS

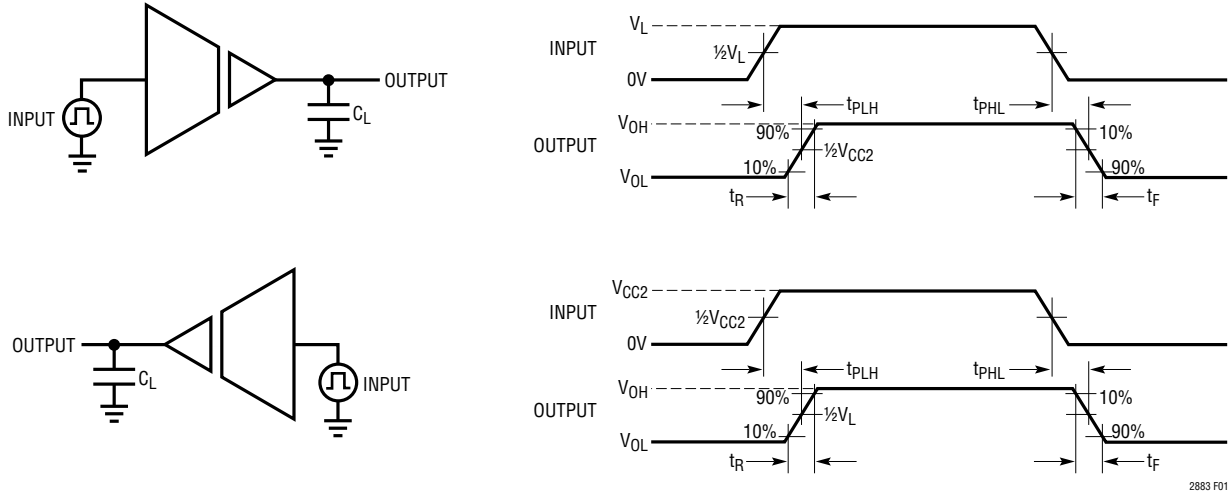

Figure 1. Logic Timing Measurements

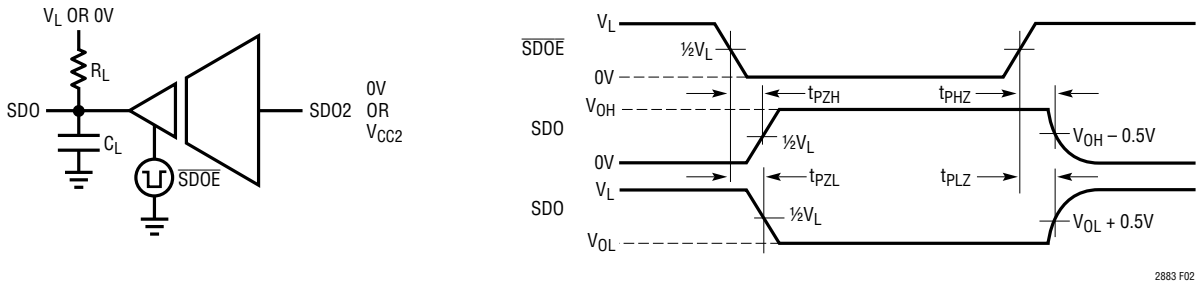

Figure 2. Logic Enable/Disable Time

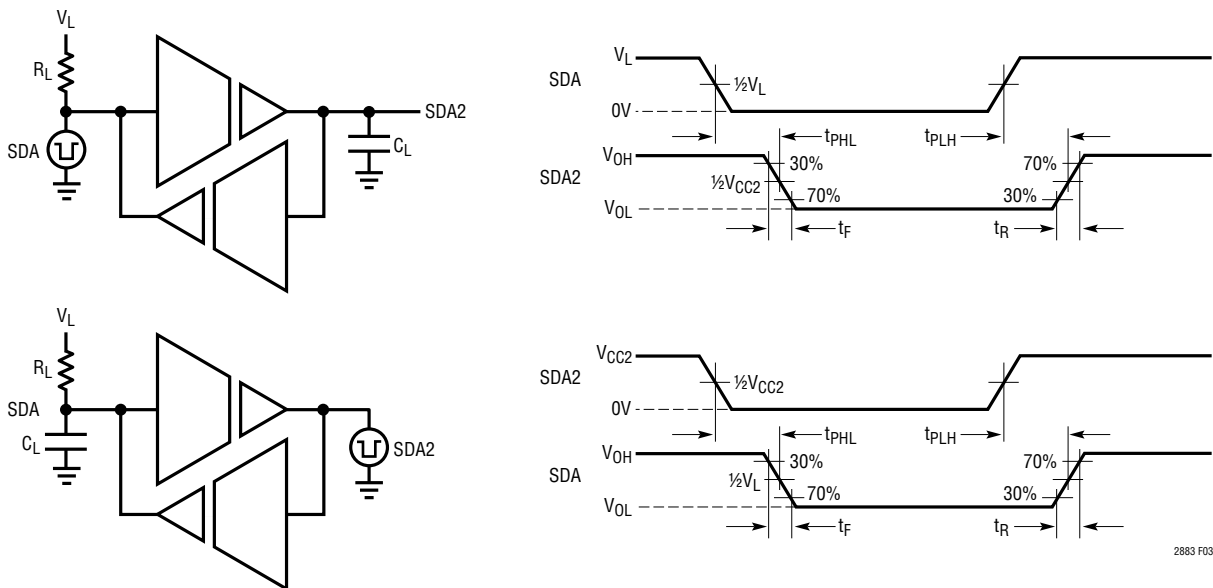

Figure 3. I²C Timing Measurements

APPLICATIONS INFORMATION

Overview

The LTM2883 digital μ Module isolator provides a galvanically-isolated robust logic interface, powered by an integrated, regulated DC/DC converter, complete with decoupling capacitors. The LTM2883 is ideal for use in networks where grounds can take on different voltages. Isolation in the LTM2883 blocks high voltage differences, eliminates ground loops and is extremely tolerant of common mode transients between ground planes. Error-free operation is maintained through common mode events greater than 30kV/ μ s providing excellent noise isolation.

Isolator μ Module Technology

The LTM2883 utilizes isolator μ Module technology to translate signals and power across an isolation barrier. Signals on either side of the barrier are encoded into pulses and translated across the isolation boundary using coreless transformers formed in the μ Module substrate. This system, complete with data refresh, error checking, safe shutdown on fail, and extremely high common mode immunity, provides a robust solution for bidirectional signal isolation. The μ Module technology provides the means to combine the isolated signaling with multiple regulators and a powerful isolated DC/DC converter in one small package.

DC/DC Converter

The LTM2883 contains a fully integrated DC/DC converter, including the transformer, so that no external components are necessary. The logic side contains a full-bridge driver, running at 2MHz, and is AC-coupled to a single transformer primary. A series DC blocking capacitor prevents transformer saturation due to driver duty cycle imbalance. The transformer scales the primary voltage, and is rectified by a full-wave voltage doubler. This topology allows for a single diode drop, as in a center tapped full-wave bridge, and eliminates transformer saturation caused by secondary imbalances.

The DC/DC converter is connected to a low dropout regulator (LDO) to provide a regulated 5V output.

An integrated boost converter generates a regulated 14V supply and a charge pumped $-14V$ supply. These rails are regulated to $\pm 12.5V$ respectively by low dropout regulators. Performance of the $-12.5V$ supply is enhanced by loading

the 12.5V supply. A load current of 1.5mA is sufficient to improve static and dynamic load regulation characteristics of the $-12.5V$ output. The increased load allows the boost regulator to operate continuously and in turn improves the regulation of the inverting charge pump.

The internal power solution is sufficient to provide a minimum of 20mA of current from V_{CC2} and V^+ , and 15mA from V^- . V_{CC} and V_{CC2} are each bypassed with 2.2 μ F ceramic capacitors, and V^+ and V^- are bypassed with 1 μ F ceramic capacitors.

V_L Logic Supply

A separate logic supply pin V_L allows the LTM2883 to interface with any logic signal from 1.62V to 5.5V as shown in Figure 4. Simply connect the desired logic supply to V_L .

There is no interdependency between V_{CC} and V_L ; they may simultaneously operate at any voltage within their specified operating ranges and sequence in any order. V_L is bypassed internally by a 2.2 μ F capacitor.

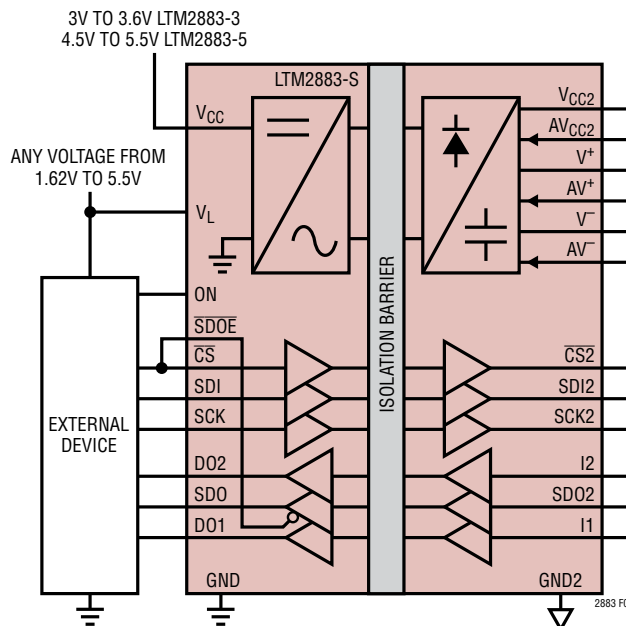

Figure 4. V_{CC} and V_L Are Independent

Hot-Plugging Safely

Caution must be exercised in applications where power is plugged into the LTM2883's power supplies, V_{CC} or V_L , due to the integrated ceramic decoupling capacitors. The

2883fc

APPLICATIONS INFORMATION

parasitic cable inductance along with the high Q characteristics of ceramic capacitors can cause substantial ringing which could exceed the maximum voltage ratings and damage the LTM2883. Refer to Linear Technology Application Note 88, entitled Ceramic Input Capacitors Can Cause Overvoltage Transients for a detailed discussion and mitigation of this phenomenon.

Isolated Supply Adjustable Operation

The three isolated power rails may be adjusted by connection of a single resistor from the adjust pin of each output to its associated output voltage or to GND2. The pre-configured voltages represent the maximums for guaranteed performance. Figure 5 illustrates configuration of the output power rails for $V_{CC2} = 3.3V$, $V^+ = 10V$, and $V^- = -10V$.

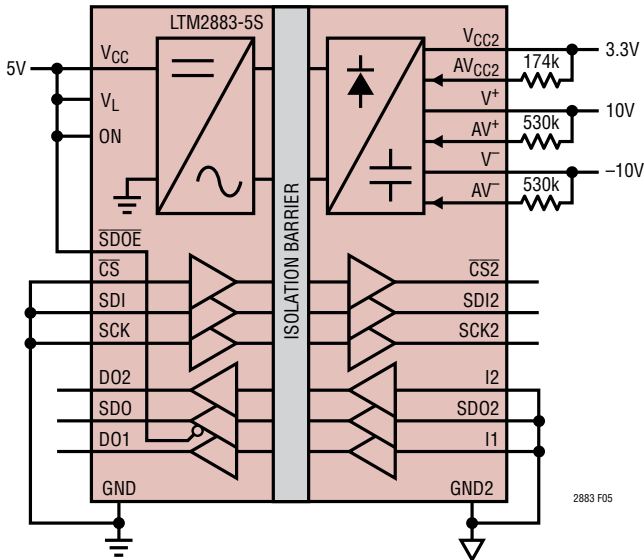

Figure 5. Adjustable Voltage Rails

To decrease the output voltage a resistor must be connected from the output voltage pin to the associated adjust pin. To increase the output voltage connect a resistor to the adjust pin to GND2. Use the equations listed in Table 1 to calculate the resistances required to adjust each output. The output voltage adjustment range for V_{CC2} is 3V to 5.5V. Adjustment range for V^+ and V^- is $\pm 1.22V$ to approximately $\pm 13.5V$. Operation at low output voltages for V^+ or V^- may result in thermal shutdown due to low dropout regulator power dissipation.

Table 1. Voltage Adjustment Formula

OUTPUT VOLTAGE	RESISTOR (Ax TO Vx) TO REDUCE OUTPUT	RESISTOR (Ax TO GND2) TO INCREASE OUTPUT
V_{CC2}	$\frac{110k \cdot (V_{CC2} - 0.6)}{5 - V_{CC2}}$	$\frac{66k}{V_{CC2} - 5}$
V^+, V^-	$\frac{150k \cdot (V^+, V^- - 1.22)}{12.5 - V^+, V^- }$	$\frac{183k}{ V^+, V^- - 12.5}$

Channel Timing Uncertainty

Multiple channels are supported across the isolation boundary by encoding and decoding of the inputs and outputs. Up to three signals in each direction are assembled as a serial packet and transferred across the isolation barrier. The time required to transfer all 3 bits is 100ns maximum, and sets the limit for how often a signal can change on the opposite side of the barrier. Encoding transmission is independent for each data direction. The technique used assigns SCK or SCL on the logic side, and SDO2 or I2 on the isolated side, the highest priority such that there is no jitter on the associated output channels, only delay. This preemptive scheme will produce a certain amount of uncertainty on the other isolation channels. The resulting pulse width uncertainty on these low priority channels is typically $\pm 6ns$, but may vary up to $\pm 44ns$ if the low priority channels are not encoded within the same high priority serial packet.

Serial Peripheral Interface (SPI) Bus

The LTM2883-S provides a SPI compatible isolated interface. The maximum data rate is a function of the inherent channel propagation delays, channel to channel pulse width uncertainty, and data direction requirements. Channel timing is detailed in Figures 5 through 8 and Tables 3 and 4. The SPI protocol supports four unique timing configurations defined by the clock polarity (CPOL) and clock phase (CPHA) summarized in Table 2.

Table 2. SPI Mode

CPOL	CPHA	DATA TO (CLOCK) RELATIONSHIP	
0	0	Sample (Rising)	Set-Up (Falling)
0	1	Set-Up (Rising)	Sample (Falling)
1	0	Sample (Falling)	Set-Up (Rising)
1	1	Set-Up (Falling)	Sample (Rising)

2883fc

APPLICATIONS INFORMATION

The maximum data rate for bidirectional communication is 4MHz, based on a synchronous system, as detailed in the timing waveforms. Slightly higher data rates may be achieved by skewing the clock duty cycle and minimizing the SDO to SCK set-up time, however the clock rate is still dominated by the system propagation delays. A discussion of the critical timing paths relative to Figure 6 and 7 follows.

- \overline{CS} to SCK (master sample SDO, 1st SDO valid)
 - $t_0 \rightarrow t_1$ $\approx 50\text{ns}$, \overline{CS} to $\overline{CS2}$ propagation delay
 - $t_1 \rightarrow t_{1+}$ Isolated slave device propagation (response time), asserts SDO2
 - $t_1 \rightarrow t_3$ $\approx 50\text{ns}$, SDO2 to SDO propagation delay
 - $t_3 \rightarrow t_5$ Set-up time for master SDO to SCK

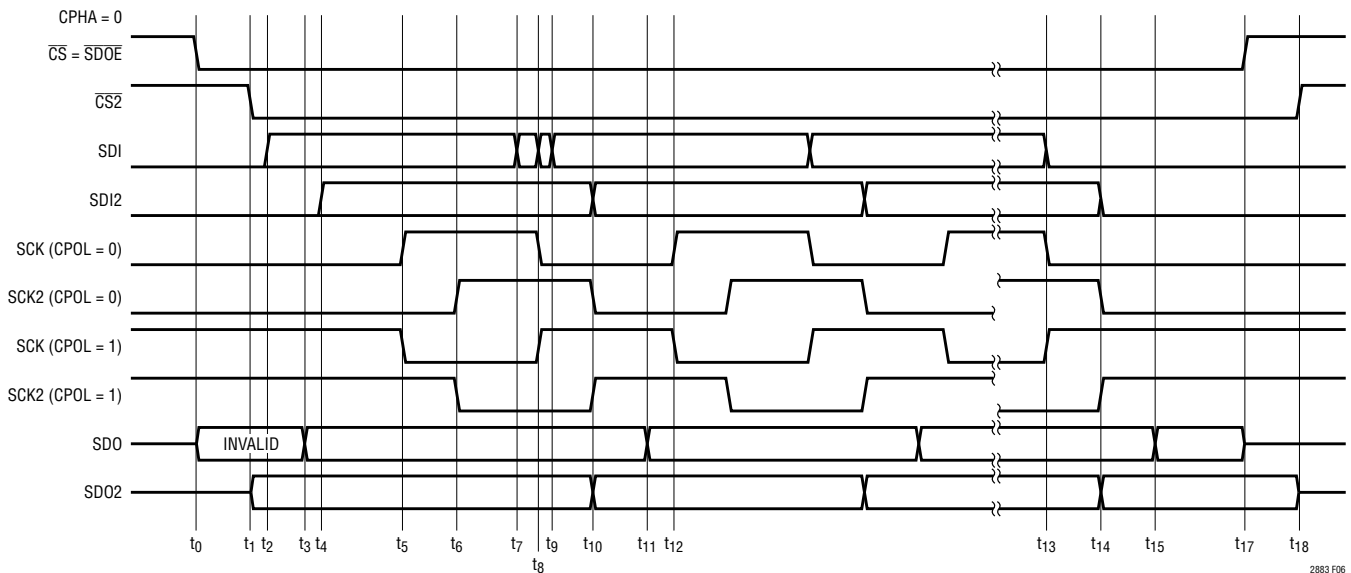

Figure 6. SPI Timing, Bidirectional, CPHA = 0

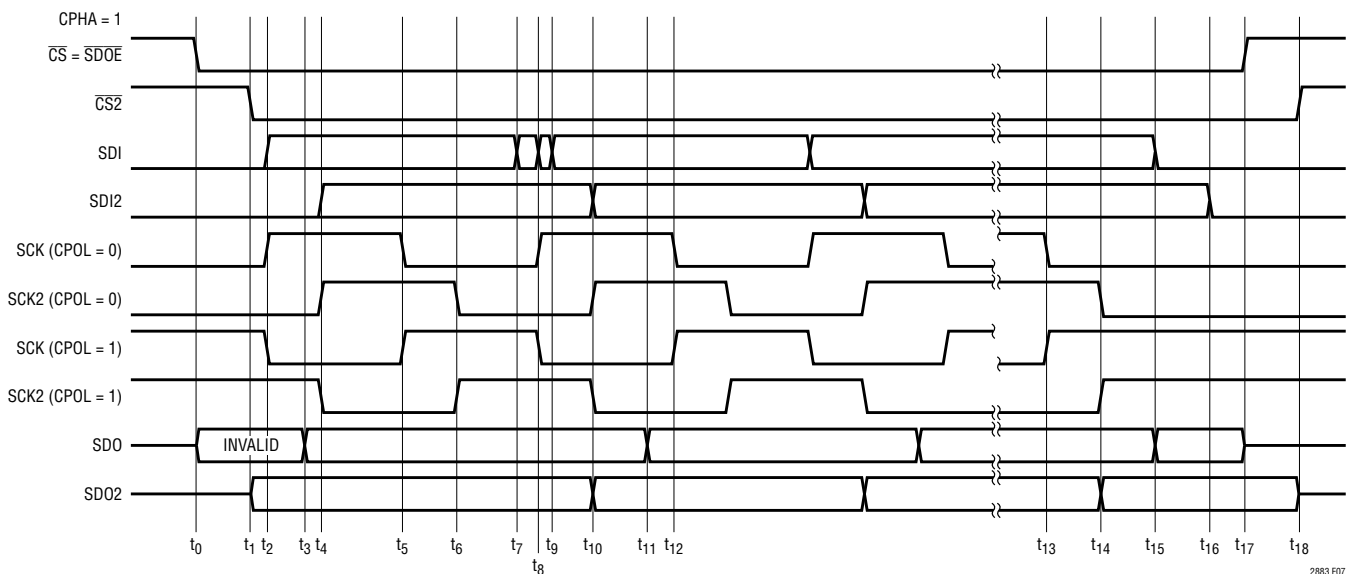

Figure 7. SPI Timing, Bidirectional, CPHA = 1

APPLICATIONS INFORMATION

- SDI to SCK (master data write to slave)
 - $t_2 \rightarrow t_4$ $\approx 50\text{ns}$, SDI to SDI2 propagation delay
 - $t_5 \rightarrow t_6$ $\approx 50\text{ns}$, SCK to SCK2 propagation delay
 - $t_2 \rightarrow t_5$ $\geq 50\text{ns}$, SDI to SCK, separate packet non-zero set-up time
 - $t_4 \rightarrow t_6$ $\geq 50\text{ns}$, SDI2 to SCK2, separate packet non-zero set-up time
- SDO to SCK (master sample SDO, subsequent SDO valid)
 - t_8 set-up data transition SDI and SCK
 - $t_8 \rightarrow t_{10}$ $\approx 50\text{ns}$, SDI to SDI2 and SCK to SCK2 propagation delay
 - t_{10} SDO2 data transition in response to SCK2
 - $t_{10} \rightarrow t_{11}$ $\approx 50\text{ns}$, SDO2 to SDO propagation delay
 - $t_{11} \rightarrow t_{12}$ Set-up time for master SDO to SCK

Table 3. Bidirectional SPI Timing Event Description

TIME	CPHA	EVENT DESCRIPTION
t_0	0, 1	Asynchronous chip select, may be synchronous to SDI but may not lag by more than 3ns. Logic side slave data output enabled, initial data is not equivalent to slave device data output
t_0 to t_1 , t_{17} to t_{18}	0, 1	Propagation delay chip select, logic to isolated side, 50ns typical
t_1	0, 1	Slave device chip select output data enable
t_2	0	Start of data transmission, data set-up
	1	Start of transmission, data and clock set-up. Data transition must be within -13ns to 3ns of clock edge
t_1 to t_3	0, 1	Propagation delay of slave data, isolated to logic side, 50ns typical
t_3	0, 1	Slave data output valid, logic side
t_2 to t_4	0	Propagation delay of data, logic side to isolated side
	1	Propagation delay of data and clock, logic side to isolated side
t_5	0, 1	Logic side data sample time, half clock period delay from data set-up transition
t_5 to t_6	0, 1	Propagation delay of clock, logic to isolated side
t_6	0, 1	Isolated side data sample time
t_8	0, 1	Synchronous data and clock transition, logic side
t_7 to t_8	0, 1	Data to clock delay, must be $\leq 13\text{ns}$
t_8 to t_9	0, 1	Clock to data delay, must be $\leq 3\text{ns}$
t_8 to t_{10}	0, 1	Propagation delay clock and data, logic to isolated side
t_{10} , t_{14}	0, 1	Slave device data transition
t_{10} to t_{11} , t_{14} to t_{15}	0, 1	Propagation delay slave data, isolated to logic side
t_{11} to t_{12}	0, 1	Slave data output to sample clock set-up time
t_{13}	0	Last data and clock transition logic side
	1	Last sample clock transition logic side
t_{13} to t_{14}	0	Propagation delay data and clock, logic to isolated side
	1	Propagation delay clock, logic to isolated side
t_{15}	0	Last slave data output transition logic side
	1	Last slave data output and data transition, logic side
t_{15} to t_{16}	1	Propagation delay data, logic to isolated side
t_{17}	0, 1	Asynchronous chip select transition, end of transmission. Disable slave data output logic side
t_{18}	0, 1	Chip select transition isolated side, slave data output disabled

APPLICATIONS INFORMATION

Maximum data rate for single direction communication, master to slave, is 8MHz, limited by the systems encoding/decoding scheme or propagation delay. Timing details for both variations of clock phase are shown in Figures 8 and 9 and Table 4.

Additional requirements to insure maximum data rate are:

- \overline{CS} is transmitted prior to (asynchronous) or within the same (synchronous) data packet as SDI

- SDI and SCK set-up data transition occur within the same data packet. Referencing Figure 6, SDI can precede SCK by up to 13ns ($t_7 \rightarrow t_8$) or lag SCK by 3ns ($t_8 \rightarrow t_9$) and not violate this requirement. Similarly in Figure 8, SDI can precede SCK by up to 13ns ($t_4 \rightarrow t_5$) or lag SCK by 3ns ($t_5 \rightarrow t_6$).

Inter-IC Communication (I²C) Bus

The LTM2883-I provides an I²C compatible isolated interface, Clock (SCL) is unidirectional, supporting master mode only, and data (SDA) is bidirectional. The maximum

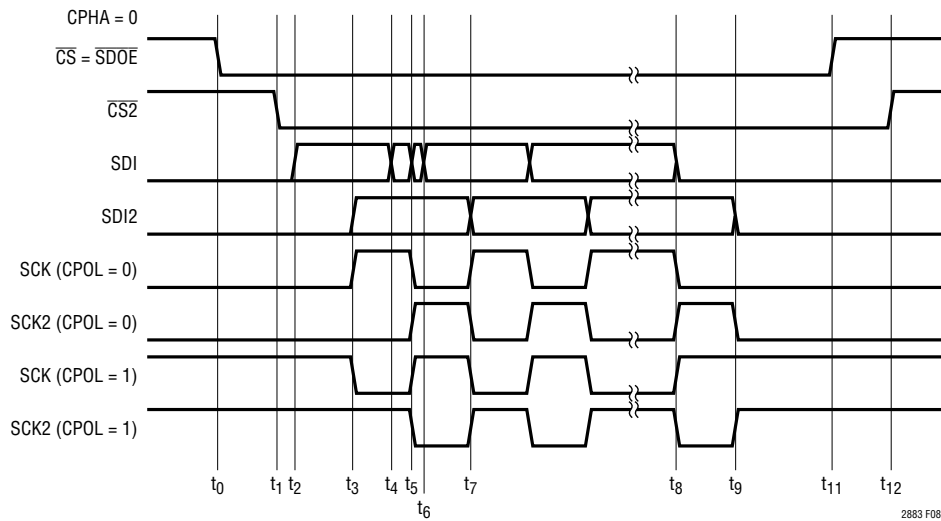

Figure 8. SPI Timing, Unidirectional, CPHA = 0

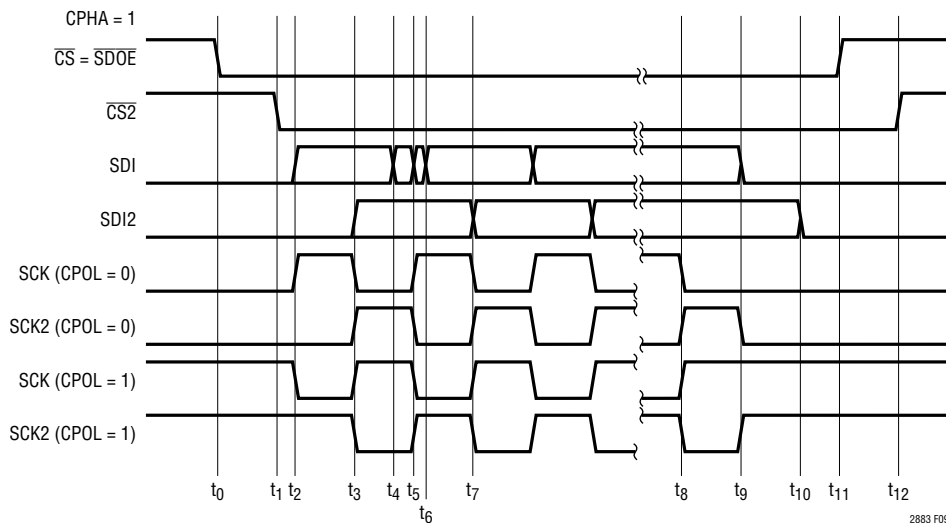

Figure 9. SPI Timing, Unidirectional, CPHA = 1

2883fc

APPLICATIONS INFORMATION

Table 4. Unidirectional SPI Timing Event Description

TIME	CPHA	EVENT DESCRIPTION
t_0	0, 1	Asynchronous chip select, may be synchronous to SDI but may not lag by more than 3ns
t_0 to t_1	0, 1	Propagation delay chip select, logic to isolated side
t_2	0	Start of data transmission, data set-up
	1	Start of transmission, data and clock set-up. Data transition must be within -13ns to 3ns of clock edge
t_2 to t_3	0	Propagation delay of data, logic side to isolated side
	1	Propagation delay of data and clock, logic side to isolated side
t_3	0, 1	Logic side data sample time, half clock period delay from data set-up transition
t_3 to t_5	0, 1	Clock propagation delay, clock and data transition
t_4 to t_5	0, 1	Data to clock delay, must be $\leq 13\text{ns}$
t_5 to t_6	0, 1	Clock to data delay, must be $\leq 3\text{ns}$
t_5 to t_7	0, 1	Data and clock propagation delay
t_8	0	Last clock and data transition
	1	Last clock transition
t_8 to t_9	0	Clock and data propagation delay
	1	Clock propagation delay
t_9 to t_{10}	1	Data propagation delay
t_{11}	0, 1	Asynchronous chip select transition, end of transmission
t_{12}	0, 1	Chip select transition isolated side

data rate is 400kHz which supports fast-mode I²C. Timing is detailed in Figure 10. The data rate is limited by the slave acknowledge setup time ($t_{\text{SU;ACK}}$), consisting of the I²C standard minimum setup time ($t_{\text{SU;DAT}}$) of 100ns, maximum clock propagation delay of 225ns, glitch filter and isolated data delay of 350ns maximum, and the combined isolated and logic data fall time of 500ns at maximum bus loading. The total setup time reduces the I²C data hold time ($t_{\text{HD;DAT}}$) to a maximum of 125ns, guaranteeing sufficient data setup time ($t_{\text{SU;ACK}}$).

The isolated side bidirectional serial data pin, SDA2, simplified schematic is shown in Figure 11. An internal

1.8mA current source provides a pull-up for SDA2. Do not connect any other pull-up device to SDA2. This current source is sufficient to satisfy the system requirements for bus capacitances greater than 200pF in FAST mode and greater than 400pF in STANDARD mode.

Additional proprietary circuitry monitors the slew rate on the SDA and SDA2 signals to manage directional control across the isolation barrier. Slew rates on both pins must be greater than $1\text{V}/\mu\text{s}$ for proper operation.

The logic side bidirectional serial data pin, SDA, requires a pull-up resistor or current source connected to V_L . Follow

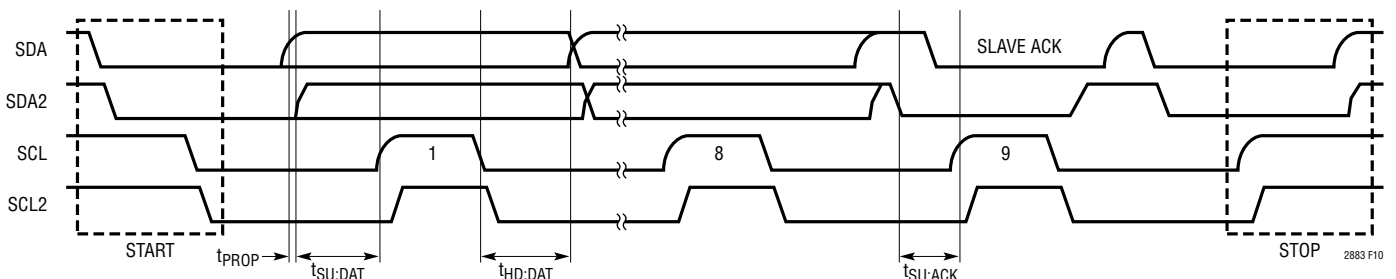
Figure 10. I²C Timing Diagram

2883fc

APPLICATIONS INFORMATION

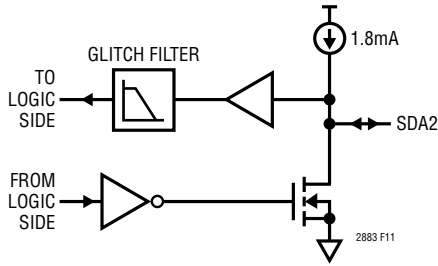

Figure 11. Isolated SDA2 Pin Schematic

the requirements in Figures 12 and 13 for the appropriate pull-up resistor on SDA that satisfies the desired rise time specifications and V_{OL} maximum limits for FAST and STANDARD modes. The resistance curves represent the maximum resistance boundary; any value may be used to the left of the appropriate curve.

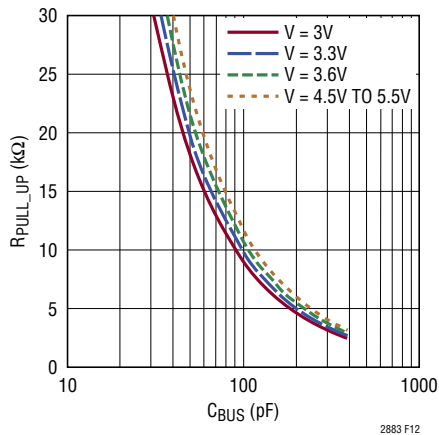

Figure 12. Maximum Standard Speed Pull-Up Resistance on SDA

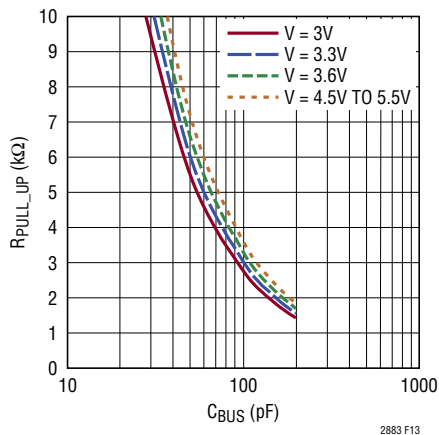

Figure 13. Maximum Fast Speed Pull-Up Resistance on SDA

The isolated side clock pin, SCL2, has a weak push-pull output driver; do not connect an external pull-up device. SCL2 is compatible with I²C devices without clock stretching. On lightly loaded connections, a 100pF capacitor from SCL2 to GND2 or RC low-pass filter ($R = 500\Omega$ $C = 100pF$) can be used to increase the rise and fall times and minimize noise.

Some consideration must be given to signal coupling between SCL2 and SDA2. Separate these signals on a printed circuit board or route with ground between. If these signals are wired off board, twist SCL2 with V_{CC2} and/or GND2 and SDA2 with GND2 and/or V_{CC2} , do not twist SCL2 and SDA2 together. If coupling between SCL2 and SDA2 is unavoidable, place the aforementioned RC filter at the SCL2 pin to reduce noise injection onto SDA2.

RF, Magnetic Field Immunity

The isolator μ Module technology used within the LTM2883 has been independently evaluated, and successfully passed the RF and magnetic field immunity testing requirements per European Standard EN 55024, in accordance with the following test standards:

- EN 61000-4-3 Radiated, Radio-Frequency, Electromagnetic Field Immunity
- EN 61000-4-8 Power Frequency Magnetic Field Immunity
- EN 61000-4-9 Pulsed Magnetic Field Immunity

Tests were performed using an unshielded test card designed per the data sheet PCB layout recommendations. Specific limits per test are detailed in Table 5.

Table 5.

TEST	FREQUENCY	FIELD STRENGTH
EN 61000-4-3 Annex D	80MHz to 1GHz	10V/m
	1.4MHz to 2GHz	3V/m
	2GHz to 2.7GHz	1V/m
EN 61000-4-8 Level 4	50Hz and 60Hz	30A/m
EN 61000-4-8 Level 5	60Hz	100A/m*
EN 61000-4-9 Level 5	Pulse	1000A/m

*non IEC method

APPLICATIONS INFORMATION

PCB Layout

The high integration of the LTM2883 makes PCB layout very simple. However, to optimize its electrical isolation characteristics, EMI, and thermal performance, some layout considerations are necessary.

- Under heavily loaded conditions V_{CC} and GND current can exceed 300mA. Sufficient copper must be used on the PCB to insure resistive losses do not cause the supply voltage to drop below the minimum allowed level. Similarly, the V_{CC2} and GND2 conductors must be sized to support any external load current. These heavy copper traces will also help to reduce thermal stress and improve the thermal conductivity.
- Input and output decoupling is not required, since these components are integrated within the package. An additional bulk capacitor with a value of 6.8 μ F to 22 μ F is recommended. The high ESR of this capacitor reduces board resonances and minimizes voltage spikes caused by hot plugging of the supply voltage. For EMI sensitive applications, an additional low ESL ceramic capacitor of 1 μ F to 4.7 μ F, placed as close to the power and ground terminals as possible, is recommended. Alternatively, a number of smaller value parallel capacitors may be used to reduce ESL and achieve the same net capacitance.
- Do not place copper on the PCB between the inner columns of pads. This area must remain open to withstand the rated isolation voltage.
- The use of solid ground planes for GND and GND2 is recommended for non-EMI critical applications to optimize signal fidelity, thermal performance, and to minimize RF emissions due to uncoupled PCB trace conduction. The drawback of using ground planes, where EMI is of concern, is the creation of a dipole antenna structure which can radiate differential voltages formed between GND and GND2. If ground planes are used it is recommended to minimize their area, and use contiguous planes as any openings or splits can exacerbate RF emissions.
- For large ground planes a small capacitance (≤ 330 pF) from GND to GND2, either discrete or embedded within the substrate, provides a low impedance current return path for the module parasitic capacitance, minimizing

any high frequency differential voltages and substantially reducing radiated emissions. Discrete capacitance will not be as effective due to parasitic ESL. In addition, voltage rating, leakage, and clearance must be considered for component selection. Embedding the capacitance within the PCB substrate provides a near ideal capacitor and eliminates component selection issues; however, the PCB must be 4 layers. Care must be exercised in applying either technique to insure the voltage rating of the barrier is not compromised.

The PCB layout in Figures 14a and 14b shows the low EMI demo board for the LTM2883. The demo board uses a combination of EMI mitigation techniques, including both embedded PCB bridge capacitance and discrete GND to GND2 capacitors. Two safety rated type Y2 capacitors are used in series, manufactured by MuRata, part number GA342QR7GF471KW01L. The embedded capacitor effectively suppresses emissions above 400MHz, whereas the discrete capacitors are more effective below 400MHz.

EMI performance is shown in Figure 15, measured using a Gigahertz Transverse Electromagnetic (GTEM) cell and method detailed in IEC 61000-4-20, Testing and Measurement Techniques – Emission and Immunity Testing in Transverse Electromagnetic Waveguides.

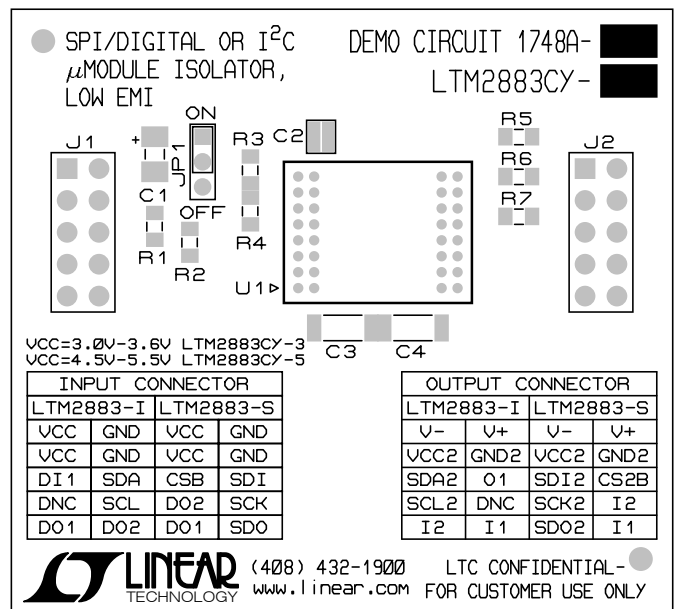
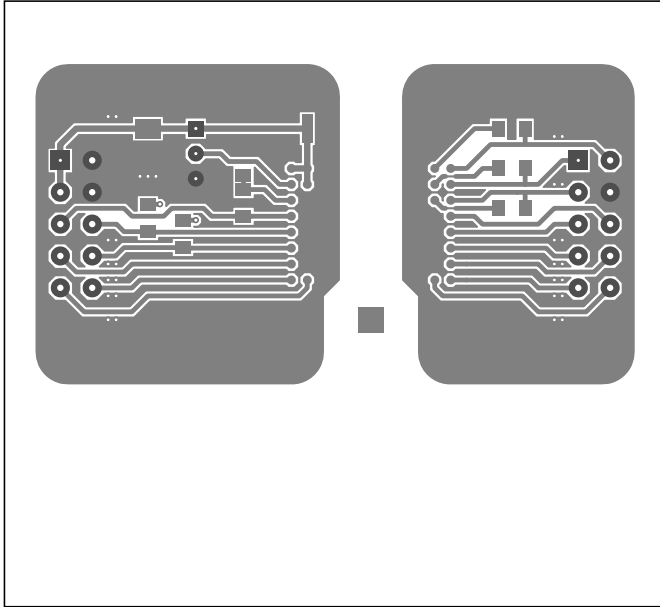

Figure 14a. LTM2883 Low EMI Demo Board Layout

APPLICATIONS INFORMATION

Top Layer



Inner Layer 2

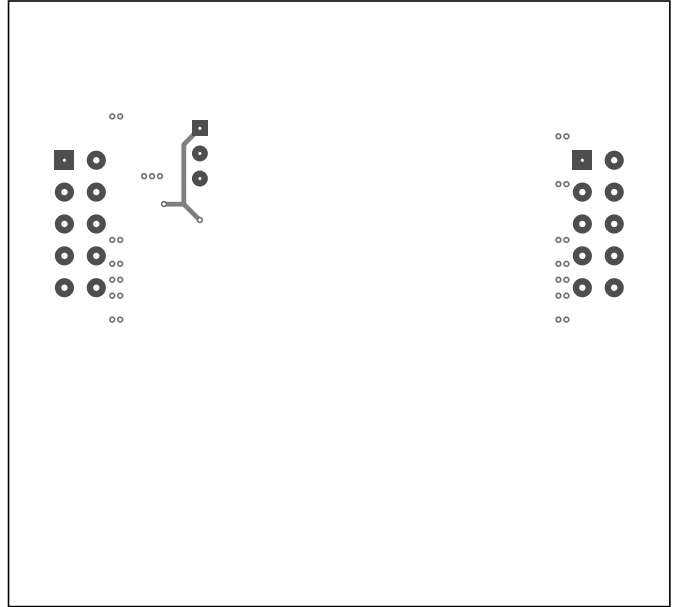

Inner Layer 1

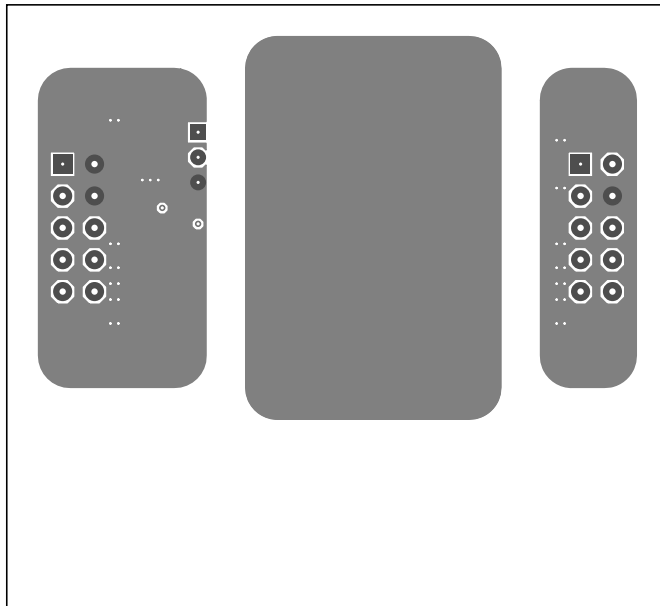

Bottom Layer

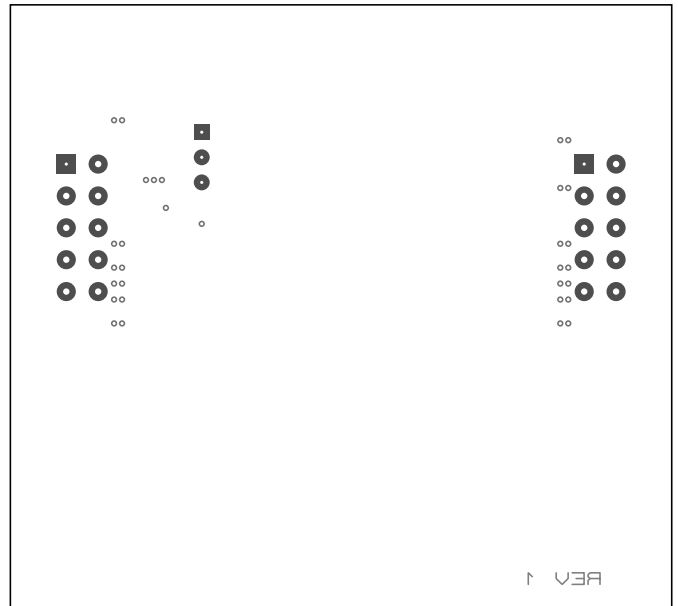

Figure 14b. LTM2883 Low EMI Demo Board Layout (DC1748A)