



Chipsmall Limited consists of a professional team with an average of over 10 year of expertise in the distribution of electronic components. Based in Hongkong, we have already established firm and mutual-benefit business relationships with customers from,Europe,America and south Asia,supplying obsolete and hard-to-find components to meet their specific needs.

With the principle of "Quality Parts,Customers Priority,Honest Operation,and Considerate Service",our business mainly focus on the distribution of electronic components. Line cards we deal with include Microchip,ALPS,ROHM,Xilinx,Pulse,ON,Everlight and Freescale. Main products comprise IC,Modules,Potentiometer,IC Socket,Relay,Connector.Our parts cover such applications as commercial,industrial, and automotives areas.

We are looking forward to setting up business relationship with you and hope to provide you with the best service and solution. Let us make a better world for our industry!



Contact us

Tel: +86-755-8981 8866 Fax: +86-755-8427 6832

Email & Skype: info@chipsmall.com Web: www.chipsmall.com

Address: A1208, Overseas Decoration Building, #122 Zhenhua RD., Futian, Shenzhen, China



3.1V_{IN} to 32V_{IN} Isolated μModule DC/DC Converter with LDO Post Regulator

FEATURES

- Complete Switch Mode Power Supply
- 725VDC Isolation
- Wide Input Voltage Range: 3.1V to 32V
- V_{OUT1} Output:
 - Up to 440mA (V_{OUT1} = 2.5V, 24V_{IN})
 - 2.5V to 13V Output Range
- V_{OUT2} Low Noise Linear Post Regulator:
 - Up to 300mA
 - 1.2V to 12V Output Range
- Current Mode Control
- Programmable Soft-Start
- User Configurable Undervoltage Lockout
- SnPb or RoHS Compliant Finish
- Low Profile (11.25mm × 9mm × 4.92mm) Surface Mount BGA Package

APPLICATIONS

- Industrial Sensors
- Industrial Switches
- Ground Loop Mitigation

DESCRIPTION

The **LTM[®]8048** is an isolated flyback μModule DC/DC converter with LDO post regulator. The LTM8048 has an isolation rating of 725VDC. Included in the package are the switching controller, power switches, transformer, and all support components. Operating over an input voltage range of 3.1V to 32V, the LTM8048 supports an output voltage range of 2.5V to 13V, set by a single resistor. There is also a linear post regulator whose output voltage is adjustable from 1.2V to 12V as set by a single resistor. Only output, input, and bypass capacitors are needed to finish the design. Other components may be used to control the soft-start control and biasing.

The LTM8048 is packaged in a thermally enhanced, compact (11.25mm × 9mm × 4.92mm) over-molded ball grid array (BGA) package suitable for automated assembly by standard surface mount equipment. The LTM8048 is available with SnPb (BGA) or RoHS compliant terminal finish.

LT, LT, LTC, LTM, Linear Technology, the Linear logo and μModule are registered trademarks of Linear Technology Corporation. All other trademarks are the property of their respective owners.

TYPICAL APPLICATION

725V DC Isolated Low Noise μModule Regulator

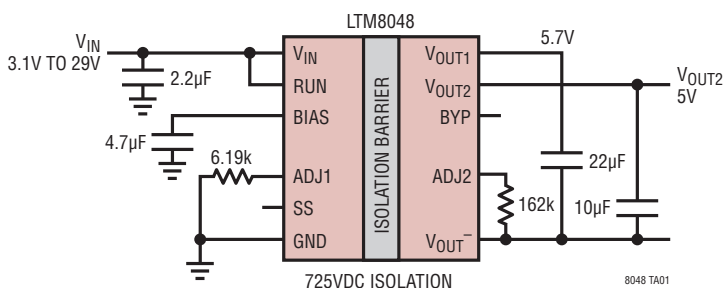

Total Output Current vs V_{IN}

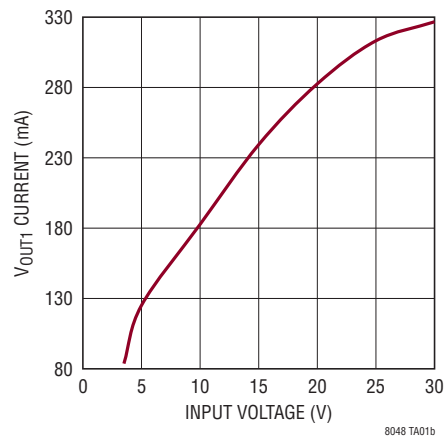

LTM8048

ABSOLUTE MAXIMUM RATINGS

(Note 1)

| | |
|------------------------------------------------|----------------|
| V_{IN} , RUN, BIAS | 32V |
| ADJ1, SS | 5V |
| V_{OUT1} Relative to V_{OUT-} | 16V |
| $(V_{IN} - GND) + (V_{OUT1} - V_{OUT-})$ | 36V |
| V_{OUT2} Relative to V_{OUT-} | +20V |
| ADJ2 Relative to V_{OUT-} | +7V |
| BYP Relative to V_{OUT-} | +0.6V |
| BIAS Above V_{IN} | 0.1V |
| GND to V_{OUT-} Isolation (Note 2) | 725VDC |
| Maximum Internal Temperature (Note 3) | 125°C |
| Maximum Solder Temperature | 250°C |
| Storage Temperature | -55°C to 125°C |

PIN CONFIGURATION

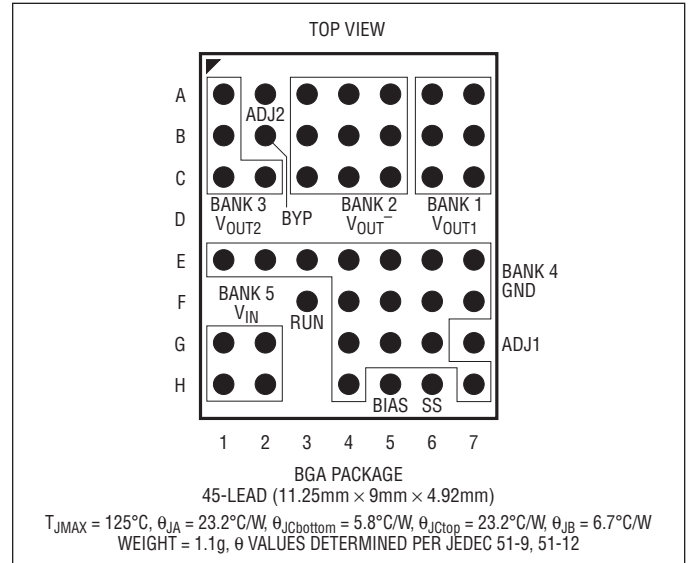

ORDER INFORMATION

| PART NUMBER | PAD OR BALL FINISH | PART MARKING* | | PACKAGE TYPE | MSL RATING | TEMPERATURE RANGE (NOTE 3) |
|----------------|--------------------|---------------|-------------|--------------|------------|----------------------------|
| | | DEVICE | FINISH CODE | | | |
| LTM8048EY#PBF | SAC305 (RoHS) | LTM8048Y | e1 | BGA | 3 | -40°C to 125°C |
| LTM8048IY#PBF | SAC305 (RoHS) | LTM8048Y | e1 | BGA | 3 | -40°C to 125°C |
| LTM8048IY | SnPb (63/37) | LTM8048Y | e0 | BGA | 3 | -40°C to 125°C |
| LTM8048MPY#PBF | SAC305 (RoHS) | LTM8048Y | e1 | BGA | 3 | -55°C to 125°C |
| LTM8048MPY | SnPb (63/37) | LTM8048Y | e0 | BGA | 3 | -55°C to 125°C |

Consult Marketing for parts specified with wider operating temperature ranges. *Device temperature grade is indicated by a label on the shipping container. Pad or ball finish code is per IPC/JEDEC J-STD-609.

- Pb-free & Non-Pb-free Part Markings:
www.linear.com/leadfree

- Recommended LGA and BGA PCB Assembly and Manufacturing Procedures:

www.linear.com/umodule/pcbassembly

- BGA Package and Tray Drawings:

www.linear.com/packaging/

ELECTRICAL CHARACTERISTICS

The ● denotes the specifications which apply over the full operating temperature range, otherwise specifications are at $T_A = 25^\circ\text{C}$, $\text{RUN} = 12\text{V}$ (Note 3).

| PARAMETER | CONDITIONS | | MIN | TYP | MAX | UNITS |
|---------------------------------------------|------------------------------------------------------------------------------------------------------------------------------------------------------------------------------------------------------------------|--------|--------------|----------------|----------------------|--------------------------------|
| Minimum Input DC Voltage | BIAS = V_{IN} | ● | | | 3.1 | V |
| V_{OUT1} DC Voltage | $R_{ADJ1} = 12.4\text{k}$ $R_{ADJ1} = 6.98\text{k}$ $R_{ADJ1} = 3.16\text{k}$ | ● | 4.75 | 2.5 5 12 | 5.25 | V V V |
| V_{IN} Quiescent Current | $V_{RUN} = 0\text{V}$ Not Switching | | | 850 | 1 | μA μA |
| V_{OUT1} Line Regulation | $6\text{V} \leq V_{IN} \leq 31\text{V}$, $I_{OUT} = 0.15\text{A}$ | | | 1.7 | | % |
| V_{OUT1} Load Regulation | $0.05\text{A} \leq I_{OUT} \leq 0.2\text{A}$ | | | 1.5 | | % |
| V_{OUT1} Ripple (RMS) | $I_{OUT} = 0.1\text{A}$ | | | 20 | | mV |
| Input Short Circuit Current | V_{OUT1} Shorted | | | 30 | | mA |
| RUN Pin Input Threshold | RUN Pin Rising | | 1.18 | 1.24 | 1.30 | V |
| RUN Pin Current | $V_{RUN} = 1\text{V}$ $V_{RUN} = 1.3\text{V}$ | | | 2.5 0.1 | | μA μA |
| SS Threshold | | | | 0.7 | | V |
| SS Sourcing Current | SS = 0V | | | -10 | | μA |
| BIAS Current | $V_{IN} = 12\text{V}$, BIAS = 5V, $I_{LOAD1} = 100\text{mA}$ | | | 8 | | mA |
| Minimum BIAS Voltage (Note 4) | $I_{LOAD1} = 100\text{mA}$ | | | | 3.1 | V |
| LDO (V_{OUT2}) Minimum Input DC Voltage | (Note 5) | | | 1.8 | 2.3 | V |
| V_{OUT2} Voltage Range | $V_{OUT1} = 16\text{V}$, R_{ADJ2} Open, No Load (Note 5) $V_{OUT1} = 16\text{V}$, $R_{ADJ2} = 41.2\text{k}$, No Load (Note 5) | | | 1.22 15.8 | | V V |
| ADJ2 Pin Voltage | $V_{OUT1} = 2\text{V}$, $I_{OUT2} = 1\text{mA}$ (Note 5) $V_{OUT1} = 2\text{V}$, $I_{OUT2} = 1\text{mA}$, E- and I-Grades (Note 5) $V_{OUT1} = 2\text{V}$, $I_{OUT2} = 1\text{mA}$, MP-Grade (Note 5) | ● ● | 1.19 1.15 | 1.22 | 1.25 1.29 | V V V |
| V_{OUT2} Line Regulation | $2\text{V} < V_{OUT1} < 16\text{V}$, $I_{OUT2} = 1\text{mA}$ (Note 5) | | | 1 | 5 | mV |
| V_{OUT2} Load Regulation | $V_{OUT1} = 5\text{V}$, $10\text{mA} < I_{OUT2} = 300\text{mA}$ (Note 5) | | | 2 | 10 | mV |
| LDO Dropout Voltage | $I_{OUT2} = 10\text{mA}$ (Note 5) $I_{OUT2} = 100\text{mA}$ (Note 5) $I_{OUT2} = 300\text{mA}$ (Note 5) | | | | 0.25 0.34 0.43 | V V V |
| V_{OUT2} Ripple (RMS) | $C_{BYP} = 0.01\mu\text{F}$, $I_{OUT2} = 300\text{mA}$, BW = 100Hz to 100kHz (Note 5) | | | 20 | | μV_{RMS} |

Note 1: Stresses beyond those listed under Absolute Maximum Ratings may cause permanent damage to the device. Exposure to any Absolute Maximum Rating condition for extended periods may affect device reliability and lifetime.

Note 2: The LTM8048 isolation is tested at 725VDC for one second in each polarity.

Note 3: The LTM8048E is guaranteed to meet performance specifications from 0°C to 125°C . Specifications over the -40°C to 125°C internal temperature range are assured by design, characterization and correlation with statistical process controls. LTM8048I is guaranteed to meet specifications over the full -40°C to 125°C internal operating temperature

range. The LTM8048MP is guaranteed to meet specifications over the full -55°C to 125°C internal operating temperature range. Note that the maximum internal temperature is determined by specific operating conditions in conjunction with board layout, the rated package thermal resistance and other environmental factors.

Note 4: This is the BIAS pin voltage at which the internal circuitry is powered through the BIAS pin and not the integrated regulator. See BIAS Pin Considerations for details.

Note 5: $V_{RUN} = 0\text{V}$ (Flyback not running), but the V_{OUT2} post regulator is powered by applying a voltage to V_{OUT1} .

TYPICAL PERFORMANCE CHARACTERISTICS Unless otherwise noted, operating conditions are as in Table 1 ($T_A = 25^\circ\text{C}$).

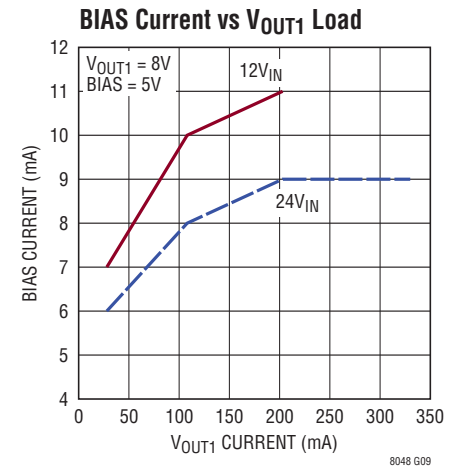
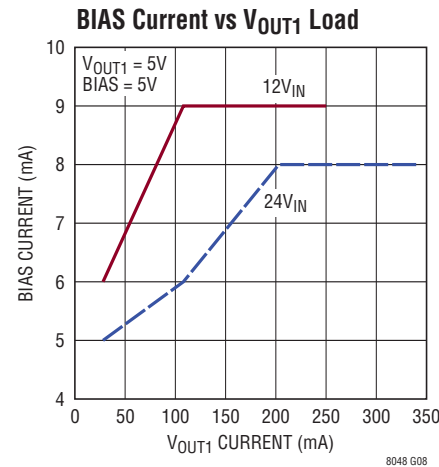
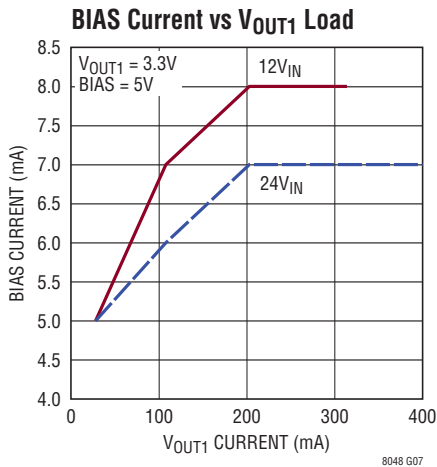
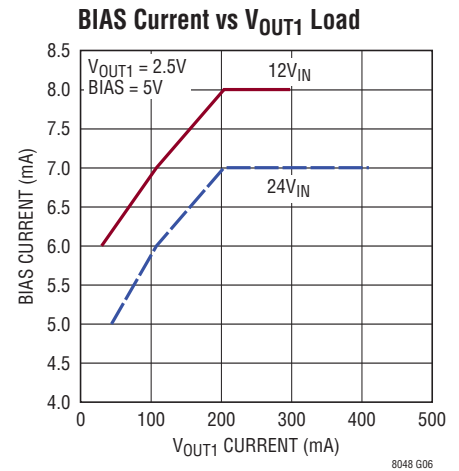
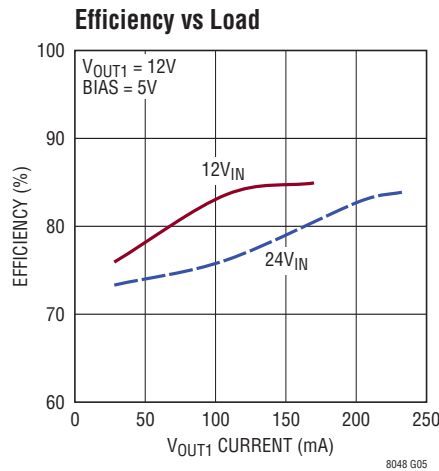
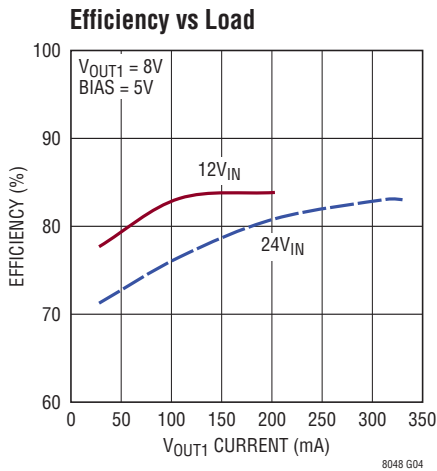
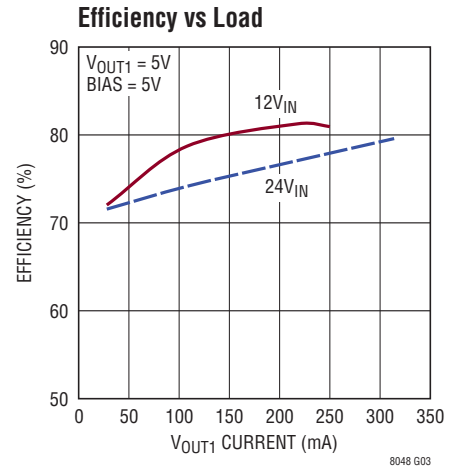
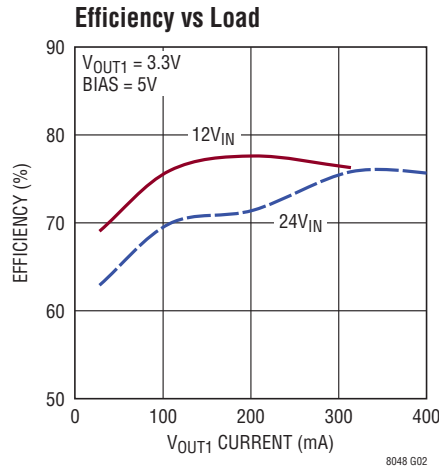
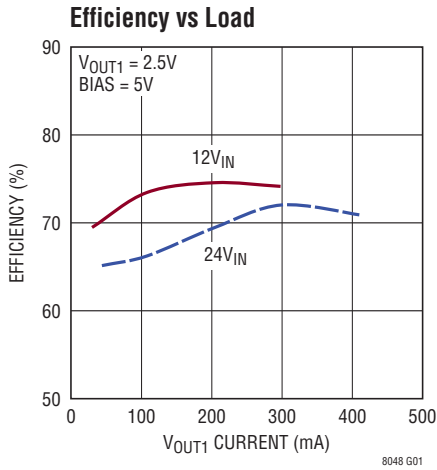

TYPICAL PERFORMANCE CHARACTERISTICS Unless otherwise noted, operating conditions are as in Table 1 ($T_A = 25^\circ\text{C}$).

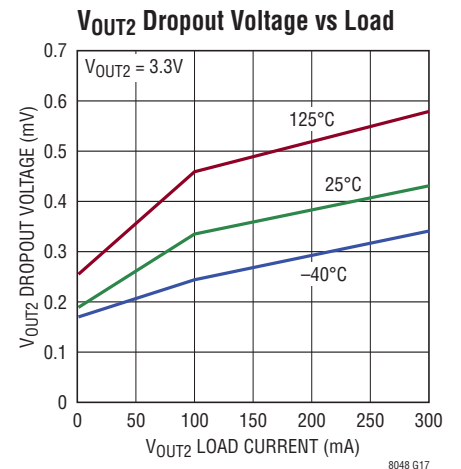
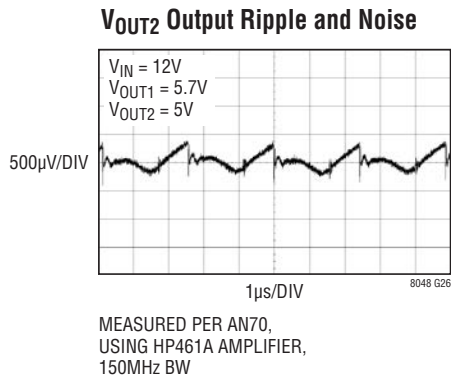
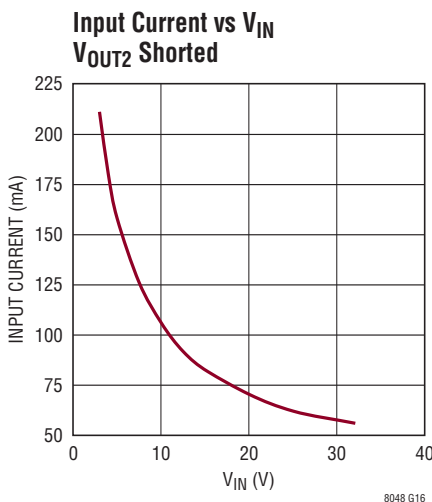
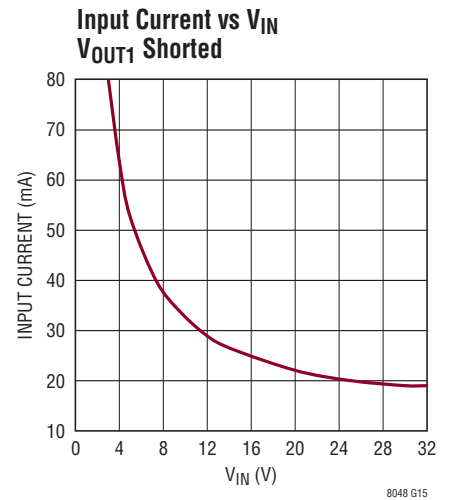
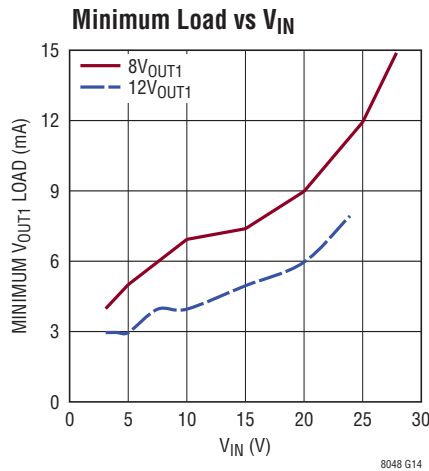
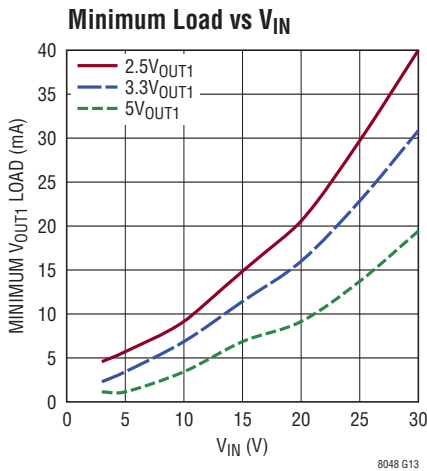
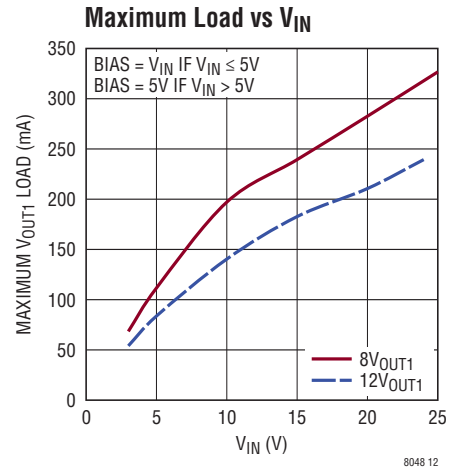
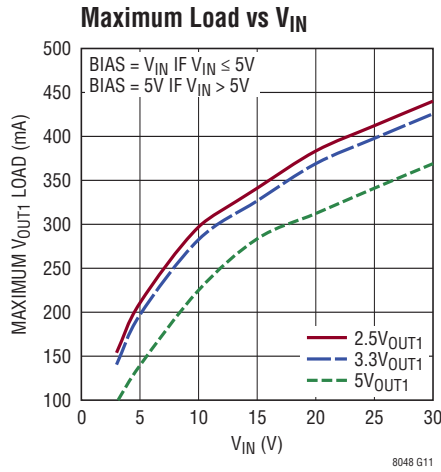
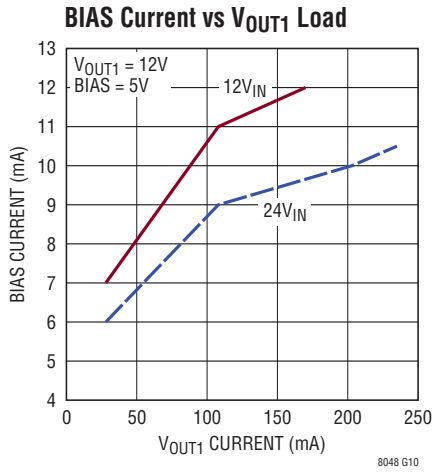

TYPICAL PERFORMANCE CHARACTERISTICS Unless otherwise noted, operating conditions are as in Table 1 ($T_A = 25^\circ\text{C}$).

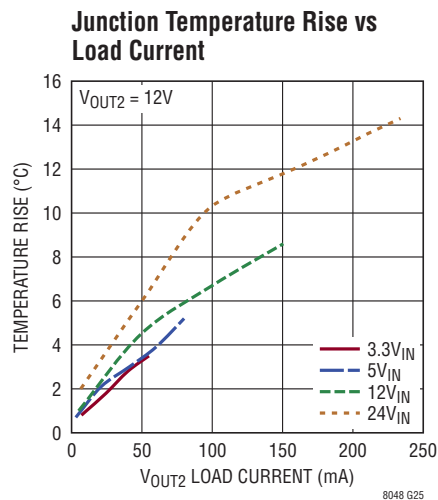
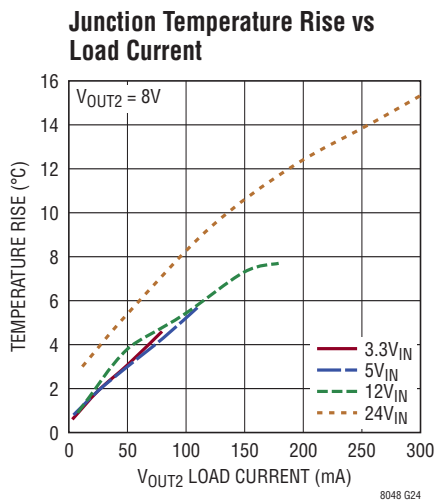
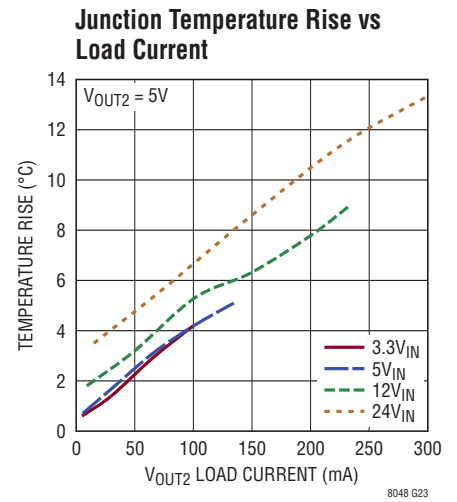
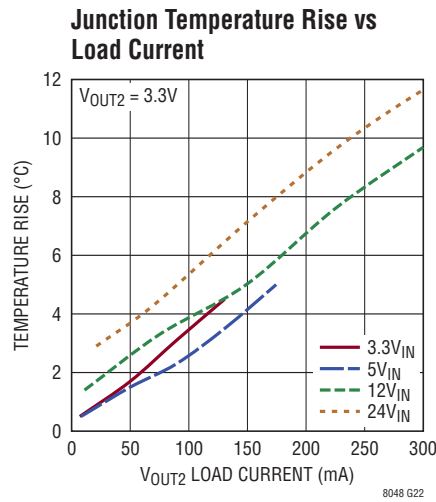
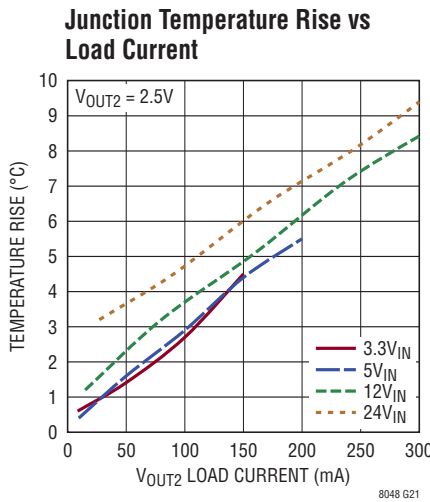
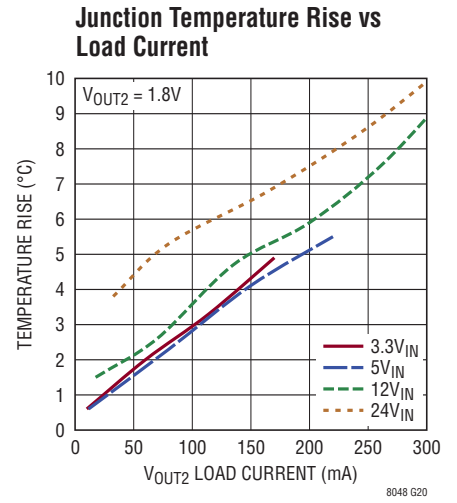
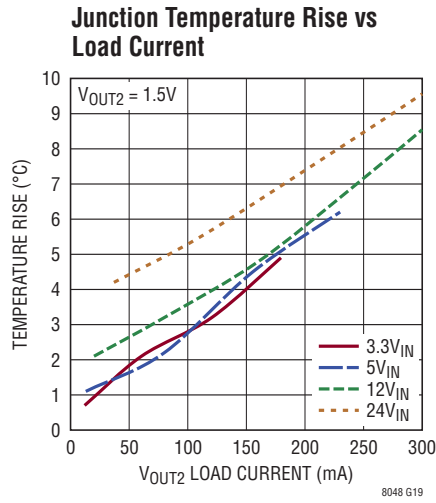
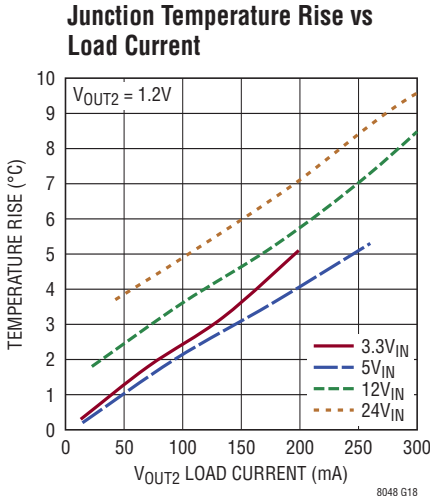

PIN FUNCTIONS

V_{OUT1} (Bank 1): V_{OUT1} and V_{OUT⁻} comprise the isolated output of the LTM8048 flyback stage. Apply an external capacitor between V_{OUT1} and V_{OUT⁻}. Do not allow V_{OUT⁻} to exceed V_{OUT1}.

V_{OUT⁻} (Bank 2): V_{OUT⁻} is the return for both V_{OUT1} and V_{OUT2}. V_{OUT1} and V_{OUT⁻} comprise the isolated output of the LTM8048. In most applications, the bulk of the heat flow out of the LTM8048 is through the GND and V_{OUT⁻} pads, so the printed circuit design has a large impact on the thermal performance of the part. See the PCB Layout and Thermal Considerations sections for more details. Apply an external capacitor between V_{OUT1} and V_{OUT⁻}.

V_{OUT2} (Bank 3): The output of the secondary side linear post regulator. Apply the load and output capacitor between V_{OUT2} and V_{OUT⁻}. See the Applications Information section for more information on output capacitance and reverse output characteristics.

GND (Bank 4): This is the primary side local ground of the LTM8048 primary. In most applications, the bulk of the heat flow out of the LTM8048 is through the GND and V_{OUT⁻} pads, so the printed circuit design has a large impact on the thermal performance of the part. See the PCB Layout and Thermal Considerations sections for more details.

V_{IN} (Bank 5): V_{IN} supplies current to the LTM8048's internal regulator and to the integrated power switch. These pins must be locally bypassed with an external, low ESR capacitor.

ADJ2 (pin A2): This is the input to the error amplifier of the secondary side LDO post regulator. This pin is internally clamped to ±7V. The ADJ2 pin voltage is 1.22V referenced to V_{OUT⁻} and the output voltage range is 1.22V to 12V. Apply a resistor from this pin to V_{OUT⁻}, using the equation $R_{ADJ2} = 608.78 / (V_{OUT2} - 1.22) \text{ k}\Omega$. If the post regulator is not used, leave this pin floating.

BYP (Pin B2): The BYP pin is used to bypass the reference of the LDO to achieve low noise performance from the linear post regulator. The BYP pin is clamped internally to ±0.6V relative to V_{OUT⁻}. A small capacitor from V_{OUT2} to this pin will bypass the reference to lower the output voltage noise. A maximum value of 0.01μF can be used for reducing output voltage noise to a typical 20μV_{RMS} over a 100Hz to 100kHz bandwidth. If not used, this pin must be left unconnected.

RUN (Pin F3): A resistive divider connected to V_{IN} and this pin programs the minimum voltage at which the LTM8048 will operate. Below 1.24V, the LTM8048 does not deliver power to the secondary. Above 1.24V, power will be delivered to the secondary and 10μA will be fed into the SS pin. When RUN is less than 1.24V, the pin draws 2.5μA, allowing for a programmable hysteresis. Do not allow a negative voltage (relative to GND) on this pin.

ADJ1 (Pins G7): Apply a resistor from this pin to GND to set the output voltage V_{OUT1} relative to V_{OUT⁻}, using the recommended value given in Table 1. If Table 1 does not list the desired V_{OUT1} value, the equation

$$R_{ADJ1} = 28.4(V_{OUT1}^{-0.879}) \text{ k}\Omega$$

may be used to approximate the value. To the seasoned designer, this exponential equation may seem unusual. The equation is exponential due to non-linear current sources that are used to temperature compensate the regulation.

BIAS (Pin H5): This pin supplies the power necessary to operate the LTM8048. It must be locally bypassed with a low ESR capacitor of at least 4.7μF. Do not allow this pin voltage to rise above V_{IN}.

SS (Pin H6): Place a soft-start capacitor here to limit inrush current and the output voltage ramp rate. Do not allow a negative voltage (relative to GND) on this pin.

BLOCK DIAGRAM

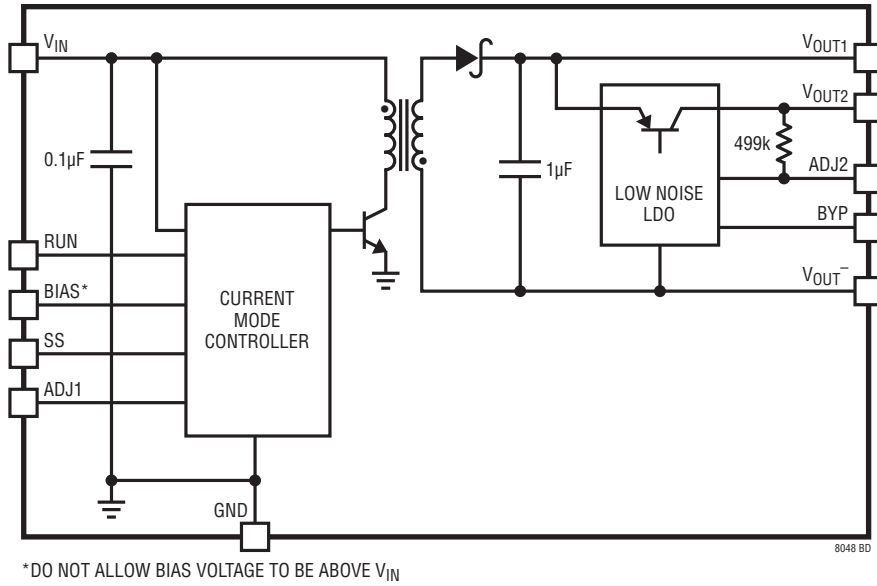

OPERATION

The LTM8048 is a stand-alone isolated flyback switching DC/DC power supply that can deliver up to 440mA of output current. This module provides a regulated output voltage programmable via one external resistor from 2.5V to 13V. It is also equipped with a high performance linear post regulator. The input voltage range of the LTM8048 is 3.1V to 32V. Given that the LTM8048 is a flyback converter, the output current depends upon the input and output voltages, so make sure that the input voltage is high enough to support the desired output voltage and load current. The Typical Performance Characteristics section gives several graphs of the maximum load versus V_{IN} for several output voltages.

A simplified block diagram is given. The LTM8048 contains a current mode controller, power switching element, power transformer, power Schottky diode, a modest amount of input and output capacitance and a high performance linear post regulator.

The LTM8048 has a galvanic primary to secondary isolation rating of 725VDC. This is verified by applying 725VDC between the primary to secondary for 1 second and then applying -725VDC for 1 second. For details please refer to the Isolation and Working Voltage section.

An internal regulator provides power to the control circuitry. The bias regulator normally draws power from the V_{IN} pin, but if the BIAS pin is connected to an external voltage higher than 3.1V, bias power will be drawn from the external source, improving efficiency. V_{BIAS} must not exceed V_{IN} . The RUN pin is used to turn on or off the LTM8048, disconnecting the output and reducing the input current to $1\mu\text{A}$ or less.

The LTM8048 is a variable frequency device. For a fixed input and output voltage, the frequency increases as the load increases. For light loads, the current through the internal transformer may be discontinuous.

The post regulator is a high performance 300mA low dropout regulator with micropower quiescent current and shutdown. The device is capable of supplying 300mA at a dropout voltage of 300mV. Output voltage noise can be lowered to $20\mu\text{V}_{\text{RMS}}$ over a 100Hz to 100kHz bandwidth with the addition of a $0.01\mu\text{F}$ reference bypass capacitor. Additionally, this reference bypass capacitor will improve transient response of the regulator, lowering the settling time for transient load conditions. The linear regulator is protected against both reverse input and reverse output voltages.

APPLICATIONS INFORMATION

For most applications, the design process is straight forward, summarized as follows:

1. Look at Table 1a (or Table 1b, if the post linear regulator is used) and find the row that has the desired input range and output voltage.
2. Apply the recommended C_{IN} , C_{OUT1} , C_{OUT2} , R_{ADJ1} , R_{ADJ2} and C_{BYP} if required.
3. Connect BIAS as indicated, or tie to an external source up to 15V or V_{IN} , whichever is less.

While these component combinations have been tested for proper operation, it is incumbent upon the user to verify proper operation over the intended system's line, load and environmental conditions. Bear in mind that the maximum output current may be limited by junction temperature, the relationship between the input and output voltage magnitude and polarity and other factors. Please refer to the graphs in the Typical Performance Characteristics section for guidance.

Capacitor Selection Considerations

The C_{IN} , C_{OUT1} and C_{OUT2} capacitor values in Table 1 are the minimum recommended values for the associated operating conditions. Applying capacitor values below those

indicated in Table 1 is not recommended, and may result in undesirable operation. Using larger values is generally acceptable, and can yield improved dynamic response, if it is necessary. Again, it is incumbent upon the user to verify proper operation over the intended system's line, load and environmental conditions.

Ceramic capacitors are small, robust and have very low ESR. However, not all ceramic capacitors are suitable. X5R and X7R types are stable over temperature and applied voltage and give dependable service. Other types, including Y5V and Z5U have very large temperature and voltage coefficients of capacitance. In an application circuit they may have only a small fraction of their nominal capacitance resulting in much higher output voltage ripple than expected.

A final precaution regarding ceramic capacitors concerns the maximum input voltage rating of the LTM8048. A ceramic input capacitor combined with trace or cable inductance forms a high-Q (underdamped) tank circuit. If the LTM8048 circuit is plugged into a live supply, the input voltage can ring to much higher than its nominal value, possibly exceeding the device's rating. This situation is easily avoided; see the Hot-Plugging Safely section.

LTM8048 Table 1a. Recommended Component Values and Configuration for Specific V_{OUT1} Voltages ($T_A = 25^\circ\text{C}$)

| V_{IN} | V_{OUT1} | V_{BIAS} | C_{IN} | C_{OUT1} | R_{ADJ1} |
|-------------|------------|---------------------|-------------------------------|--------------------------------|-------------|
| 3.1V to 32V | 2.5V | 3.1V to 15V or Open | 2.2 μF , 50V, 1206 | 100 μF , 6.3V, 1210 | 12.4k |
| 3.1V to 32V | 3.3V | 3.1V to 15V or Open | 2.2 μF , 50V, 1206 | 100 μF , 6.3V, 1210 | 10k |
| 3.1V to 29V | 5V | 3.1V to 15V or Open | 2.2 μF , 50V, 1206 | 22 μF , 16V, 1210 | 6.98k |
| 3.1V to 26V | 8V | 3.1V to 15V or Open | 2.2 μF , 50V, 1206 | 22 μF , 10V, 1206 | 4.53k |
| 3.1V to 24V | 12V | 3.1V to 15V or Open | 2.2 μF , 25V, 0805 | 10 μF , 16V, 1210 | 3.16k/12pF* |
| 9V to 15V | 2.5V | V_{IN} | 2.2 μF , 50V, 1206 | 100 μF , 6.3V, 1210 | 12.4k |
| 9V to 15V | 3.3V | V_{IN} | 2.2 μF , 50V, 1206 | 47 μF , 6.3V, 1210 | 10k |
| 9V to 15V | 5V | V_{IN} | 2.2 μF , 50V, 1206 | 22 μF , 16V, 1210 | 6.98k |
| 9V to 15V | 8V | V_{IN} | 2.2 μF , 50V, 1206 | 22 μF , 10V, 1206 | 4.53k |
| 9V to 15V | 12V | V_{IN} | 2.2 μF , 25V, 0805 | 10 μF , 16V, 1210 | 3.16k |
| 18V to 32V | 2.5V | 3.1V to 15V or Open | 2.2 μF , 50V, 1206 | 100 μF , 6.3V, 1210 | 12.4k |
| 18V to 32V | 3.3V | 3.1V to 15V or Open | 2.2 μF , 50V, 1206 | 47 μF , 6.3V, 1210 | 10k |
| 18V to 29V | 5V | 3.1V to 15V or Open | 2.2 μF , 50V, 1206 | 22 μF , 16V, 1210 | 6.98k |
| 18V to 26V | 8V | 3.1V to 15V or Open | 2.2 μF , 50V, 1206 | 22 μF , 10V, 1206 | 4.53k |
| 18V to 24V | 12V | 3.1V to 15V or Open | 2.2 μF , 50V, 1206 | 10 μF , 16V, 1210 | 3.16k/12pF* |

Note: Do not allow BIAS to exceed V_{IN} , a bulk input capacitor is required.

*Connect 3.16k in parallel with 12pF from ADJ to GND.

APPLICATIONS INFORMATION

LTM8048 Table 1b. Recommended Component Values and Configuration for Specific V_{OUT2} Voltages ($T_A = 25^\circ\text{C}$)

| V_{IN} | V_{OUT1} | V_{OUT2} | V_{BIAS} | C_{IN} | C_{OUT1} | C_{OUT2} | R_{ADJ1} | R_{ADJ2} |
|-------------|------------|------------|---------------------|-------------------------------|--------------------------------|-------------------------------|-------------|------------|
| 3.1V to 32V | 1.71V | 1.2V | 3.1V to 15V or Open | 2.2 μF , 50V, 1206 | 100 μF , 6.3V, 1210 | 10 μF , 6.3V, 1206 | 16.5k | Open |
| 3.1V to 32V | 2.02V | 1.5V | 3.1V to 15V or Open | 2.2 μF , 50V, 1206 | 100 μF , 6.3V, 1210 | 10 μF , 6.3V, 1206 | 14.7k | 2.32M |
| 3.1V to 32V | 2.34V | 1.8V | 3.1V to 15V or Open | 2.2 μF , 50V, 1206 | 100 μF , 6.3V, 1210 | 10 μF , 6.3V, 1206 | 13.3k | 1.07M |
| 3.1V to 32V | 3.08V | 2.5V | 3.1V to 15V or Open | 2.2 μF , 50V, 1206 | 100 μF , 6.3V, 1210 | 10 μF , 6.3V, 1206 | 10.5k | 487k |
| 3.1V to 32V | 3.92V | 3.3V | 3.1V to 15V or Open | 2.2 μF , 50V, 1206 | 47 μF , 6.3V, 1210 | 10 μF , 6.3V, 1206 | 8.66k | 294k |
| 3.1V to 29V | 5.7V | 5V | 3.1V to 15V or Open | 2.2 μF , 50V, 1206 | 22 μF , 16V, 1210 | 10 μF , 6.3V, 1206 | 6.19k | 162k |
| 3.1V to 26V | 8.85V | 8V | 3.1V to 15V or Open | 2.2 μF , 50V, 1206 | 22 μF , 10V, 1206 | 10 μF , 10V, 1206 | 4.12k | 88.7k |
| 3.1V to 21V | 13V | 12V | 3.1V to 15V or Open | 2.2 μF , 25V, 0805 | 10 μF , 16V, 1210 | 10 μF , 16V, 1206 | 2.94k/12pF* | 56.2k |
| 9V to 15V | 1.71V | 1.2V | V_{IN} | 2.2 μF , 50V, 1206 | 100 μF , 6.3V, 1210 | 10 μF , 6.3V, 1206 | 16.5k | Open |
| 9V to 15V | 2.02V | 1.5V | V_{IN} | 2.2 μF , 50V, 1206 | 100 μF , 6.3V, 1210 | 10 μF , 6.3V, 1206 | 14.7k | 2.32M |
| 9V to 15V | 2.34V | 1.8V | V_{IN} | 2.2 μF , 50V, 1206 | 100 μF , 6.3V, 1210 | 10 μF , 6.3V, 1206 | 13.3k | 1.07M |
| 9V to 15V | 3.08V | 2.5V | V_{IN} | 2.2 μF , 50V, 1206 | 100 μF , 6.3V, 1210 | 10 μF , 6.3V, 1206 | 10.5k | 487k |
| 9V to 15V | 3.92V | 3.3V | V_{IN} | 2.2 μF , 50V, 1206 | 47 μF , 6.3V, 1210 | 10 μF , 6.3V, 1206 | 8.66k | 294k |
| 9V to 15V | 5.7V | 5V | V_{IN} | 2.2 μF , 50V, 1206 | 22 μF , 16V, 1210 | 10 μF , 6.3V, 1206 | 6.19k | 162k |
| 9V to 15V | 8.85V | 8V | V_{IN} | 2.2 μF , 50V, 1206 | 22 μF , 10V, 1206 | 10 μF , 10V, 1206 | 4.12k | 88.7k |
| 9V to 15V | 13V | 12V | V_{IN} | 2.2 μF , 25V, 0805 | 10 μF , 16V, 1210 | 10 μF , 16V, 1206 | 2.94k/12pF* | 56.2k |
| 18V to 32V | 1.71V | 1.2V | 3.1V to 15V or Open | 2.2 μF , 50V, 1206 | 100 μF , 6.3V, 1210 | 10 μF , 6.3V, 1206 | 16.5k | Open |
| 18V to 32V | 2.02V | 1.5V | 3.1V to 15V or Open | 2.2 μF , 50V, 1206 | 100 μF , 6.3V, 1210 | 10 μF , 6.3V, 1206 | 14.7k | 2.32M |
| 18V to 32V | 2.34V | 1.8V | 3.1V to 15V or Open | 2.2 μF , 50V, 1206 | 100 μF , 6.3V, 1210 | 10 μF , 6.3V, 1206 | 13.3k | 1.07M |
| 18V to 32V | 3.08V | 2.5V | 3.1V to 15V or Open | 2.2 μF , 50V, 1206 | 100 μF , 6.3V, 1210 | 10 μF , 6.3V, 1206 | 10.5k | 487k |
| 18V to 32V | 3.92V | 3.3V | 3.1V to 15V or Open | 2.2 μF , 50V, 1206 | 47 μF , 6.3V, 1210 | 10 μF , 6.3V, 1206 | 8.66k | 294k |
| 18V to 29V | 5.7V | 5V | 3.1V to 15V or Open | 2.2 μF , 50V, 1206 | 22 μF , 16V, 1210 | 10 μF , 6.3V, 1206 | 6.19k | 162k |
| 18V to 26V | 8.85V | 8V | 3.1V to 15V or Open | 2.2 μF , 50V, 1206 | 22 μF , 10V, 1206 | 10 μF , 10V, 1206 | 4.12k | 88.7k |

Note: Do not allow BIAS to exceed V_{IN} , a bulk input capacitor is required.

*Connect 2.94k in parallel with 12pF from ADJ to GND.

BIAS Pin Considerations

The BIAS pin is the output of an internal linear regulator that powers the LTM8048's internal circuitry. It is set to 3V and must be decoupled with a low ESR capacitor of at least 4.7 μF . The LTM8048 will run properly without applying a voltage to this pin, but will operate more efficiently and dissipate less power if a voltage greater than 3.1V is applied. At low V_{IN} , the LTM8048 will be able to deliver more output current if BIAS is 3.1V or greater. Up to 32V may be applied to this pin, but a high BIAS voltage will cause excessive power dissipation in the internal circuitry. For applications with an input voltage less than 15V, the BIAS pin is typically connected directly to the V_{IN} pin. For input voltages greater than 15V, it is preferred to leave the BIAS pin separate from the V_{IN} pin, either powered from a separate voltage source or left running from the internal

regulator. This has the added advantage of keeping the physical size of the BIAS capacitor small. Do not allow BIAS to rise above V_{IN} .

Soft-Start

For many applications, it is necessary to minimize the inrush current at start-up. The built-in soft-start circuit significantly reduces the start-up current spike and output voltage overshoot by applying a capacitor from SS to GND. When the LTM8048 is enabled, whether from V_{IN} reaching a sufficiently high voltage or RUN being pulled high, the LTM8048 will source approximately 10 μA out of the SS pin. As this current gradually charges the capacitor from SS to GND, the LTM8048 will correspondingly increase the power delivered to the output, allowing for a graceful turn-on ramp.

APPLICATIONS INFORMATION

Isolation and Working Voltage

The LTM8048 isolation is tested by tying all of the primary pins together, all of the secondary pins together and subjecting the two resultant circuits to a differential of $\pm 725\text{VDC}$ for one second. This establishes the isolation voltage rating, but it does not determine the working voltage rating, which is subject to the application board layout and possibly other factors. The metal to metal separation of the primary and secondary throughout the LTM8048 substrate is 0.44mm.

ADJ and Line Regulation

For V_{OUT} greater than 8V, a capacitor connected from ADJ to GND improves line regulation. Figure 1 shows the effect of three capacitance values applied to ADJ for a load of 15mA. No capacitance has poor line regulation, while 12pF has improved line regulation. As the capacitance increases, the line regulation begins to degrade again, but in the opposite direction as having too little capacitance. Furthermore, too much capacitance from ADJ to GND may increase the minimum load required for proper regulation.

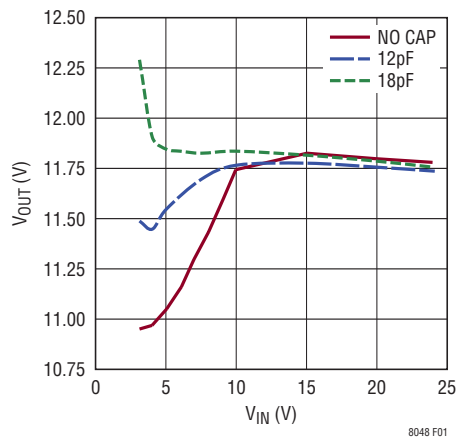

Figure 1. For Higher Output Voltages, the LTM8048 Requires Some Capacitance from ADJ to GND for Proper Line Regulation

V_{OUT2} Post Regulator

V_{OUT2} is produced by a high performance low dropout 300mA regulator. At full load, its dropout is less than 430mV over temperature. Its output is set by applying a

resistor from the R_{ADJ2} pin to GND; the value of R_{ADJ2} can be calculated by the equation:

$$R_{\text{ADJ2}} = \frac{608.78}{V_{\text{OUT2}} - 1.22} \text{ k}\Omega$$

V_{OUT1} to V_{OUT-} Reverse Voltage

The LTM8048 cannot tolerate a reverse voltage from V_{OUT1} to $V_{\text{OUT-}}$ during operation. If $V_{\text{OUT-}}$ raises above V_{OUT1} during operation, the LTM8048 may be damaged. To protect against this condition, a low forward drop power Schottky diode has been integrated into the LTM8048, anti-parallel to $V_{\text{OUT1}}/V_{\text{OUT-}}$. This can protect the output against many reverse voltage faults. Reverse voltage faults can be both steady state and transient. An example of a steady state voltage reversal is accidentally misconnecting a powered LTM8048 to a negative voltage source. An example of transient voltage reversals is a momentary connection to a negative voltage. It is also possible to achieve a V_{OUT1} reversal if the load is short-circuited through a long cable. The inductance of the long cable forms an LC tank circuit with the V_{OUT1} capacitance, which drive V_{OUT1} negative. Avoid these conditions.

V_{OUT2} Post Regulator Bypass Capacitance and Low Noise Performance

The V_{OUT2} linear regulator may be used with the addition of a 0.01 μF bypass capacitor from V_{OUT} to the BYP pin to lower output voltage noise. A good quality low leakage capacitor, such as a X5R or X75 ceramic, is recommended. This capacitor will bypass the reference of the regulator, lowering the output voltage noise to as low as 20 μVRMS . Using a bypass capacitor has the added benefit of improving transient response.

Safety Rated Capacitors

Some applications require safety rated capacitors, which are high voltage capacitors that are specifically designed and rated for AC operation and high voltage surges. These capacitors are often certified to safety standards such as UL 60950, IEC 60950 and others. In the case of the LTM8048,

APPLICATIONS INFORMATION

a common application of a safety rated capacitor would be to connect it from GND to V_{OUT^-} . To provide maximum flexibility, the LTM8048 does not include any components between GND and V_{OUT^-} . Any safety capacitors must be added externally.

The specific capacitor and circuit configuration for any application depends upon the safety requirements of the system into which the LTM8048 is being designed. Table 2 provides a list of possible capacitors and their manufacturers.

Table 2. Safety Rated Capacitors

| MANUFACTURER | PART NUMBER | DESCRIPTION |
|----------------------|------------------------|----------------------------------------------|
| Murata Electronics | GA343DR7GD472KW01L | 4700pF, 250VAC, X7R, 4.5mm × 3.2mm Capacitor |
| Johanson Dielectrics | 302R29W471KV3E-****-SC | 470pF, 250VAC, X7R, 4.5mm × 2mm Capacitor |
| Syfer Technology | 1808JA250102JCTSP | 100pF, 250VAC, COG, 1808 Capacitor |

The application of a capacitor from GND to V_{OUT^-} may also reduce the high frequency output noise on the output.

PCB Layout

Most of the headaches associated with PCB layout have been alleviated or even eliminated by the high level of integration of the LTM8048. The LTM8048 is nevertheless a switching power supply, and care must be taken to minimize electrical noise to ensure proper operation. Even with the high level of integration, you may fail to achieve specified operation with a haphazard or poor layout. See Figure 2 for a suggested layout. Ensure that the grounding and heat sinking are acceptable.

A few rules to keep in mind are:

1. Place the R_{ADJ1} and R_{ADJ2} resistors as close as possible to their respective pins.
2. Place the C_{IN} capacitor as close as possible to the V_{IN} and GND connections of the LTM8048.
3. Place the C_{OUT1} capacitor as close as possible to V_{OUT1} and V_{OUT^-} . Likewise, place the C_{OUT2} capacitor as close as possible to V_{OUT2} and V_{OUT^-} .

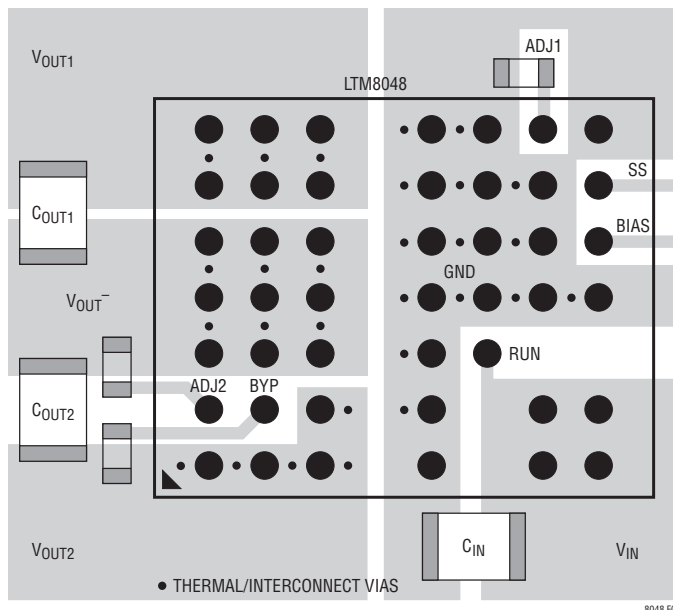

Figure 2. Layout Showing Suggested External Components, Planes and Thermal Vias

4. Place the C_{IN} and C_{OUT} capacitors such that their ground current flow directly adjacent or underneath the LTM8048.
5. Connect all of the GND connections to as large a copper pour or plane area as possible on the top layer. Avoid breaking the ground connection between the external components and the LTM8048.
6. Use vias to connect the GND copper area to the board's internal ground planes. Liberally distribute these GND vias to provide both a good ground connection and thermal path to the internal planes of the printed circuit board. Pay attention to the location and density of the thermal vias in Figure 2. The LTM8048 can benefit from the heat sinking afforded by vias that connect to internal GND planes at these locations, due to their proximity to internal power handling components. The optimum number of thermal vias depends upon the printed circuit board design. For example, a board might use very small via holes. It should employ more thermal vias than a board that uses larger holes.

Hot-Plugging Safely

The small size, robustness and low impedance of ceramic capacitors make them an attractive option for the input

APPLICATIONS INFORMATION

bypass capacitor of the LTM8048. However, these capacitors can cause problems if the LTM8048 is plugged into a live supply (see Linear Technology Application Note 88 for a complete discussion). The low loss ceramic capacitor combined with stray inductance in series with the power source forms an underdamped tank circuit, and the voltage at the V_{IN} pin of the LTM8048 can ring to more than twice the nominal input voltage, possibly exceeding the LTM8048's rating and damaging the part. A similar phenomenon can occur inside the LTM8048 module, at the output of the integrated EMI filter, with the same potential of damaging the part. If the input supply is poorly controlled or the user will be plugging the LTM8048 into an energized supply, the input network should be designed to prevent this overshoot. This can be accomplished by installing a small resistor in series to V_{IN} , but the most popular method of controlling input voltage overshoot is adding an electrolytic bulk capacitor to the V_{IN} or f_{IN} net. This capacitor's relatively high equivalent series resistance damps the circuit and eliminates the voltage overshoot. The extra capacitor improves low frequency ripple filtering and can slightly improve the efficiency of the circuit, though it can be a large component in the circuit.

Thermal Considerations

The LTM8048 output current may need to be derated if it is required to operate in a high ambient temperature. The amount of current derating is dependent upon the input voltage, output power and ambient temperature. The temperature rise curves given in the Typical Performance Characteristics section can be used as a guide. These curves were generated by the LTM8048 mounted to a 58cm² 4-layer FR4 printed circuit board. Boards of other sizes and layer count can exhibit different thermal behavior, so it is incumbent upon the user to verify proper operation over the intended system's line, load and environmental operating conditions.

For increased accuracy and fidelity to the actual application, many designers use FEA to predict thermal performance. To that end, the Pin Configuration section of the data sheet typically gives four thermal coefficients:

θ_{JA} : Thermal resistance from junction to ambient

$\theta_{JCbottm}$: Thermal resistance from junction to the bottom of the product case

θ_{JCtop} : Thermal resistance from junction to top of the product case

$\theta_{JCboard}$: Thermal resistance from junction to the printed circuit board.

While the meaning of each of these coefficients may seem to be intuitive, JEDEC has defined each to avoid confusion and inconsistency. These definitions are given in JESD 51-12, and are quoted or paraphrased as follows:

θ_{JA} is the natural convection junction-to-ambient air thermal resistance measured in a one cubic foot sealed enclosure. This environment is sometimes referred to as still air although natural convection causes the air to move. This value is determined with the part mounted to a JESD 51-9 defined test board, which does not reflect an actual application or viable operating condition.

$\theta_{JCbottm}$ is the junction-to-board thermal resistance with all of the component power dissipation flowing through the bottom of the package. In the typical μ Module converter, the bulk of the heat flows out the bottom of the package, but there is always heat flow out into the ambient environment. As a result, this thermal resistance value may be useful for comparing packages but the test conditions don't generally match the user's application.

θ_{JCtop} is determined with nearly all of the component power dissipation flowing through the top of the package. As the electrical connections of the typical μ Module converter are

APPLICATIONS INFORMATION

on the bottom of the package, it is rare for an application to operate such that most of the heat flows from the junction to the top of the part. As in the case of $\theta_{JCbottom}$, this value may be useful for comparing packages but the test conditions don't generally match the user's application.

$\theta_{JCboard}$ is the junction-to-board thermal resistance where almost all of the heat flows through the bottom of the μ Module converter and into the board, and is really the sum of the $\theta_{JCbottom}$ and the thermal resistance of the bottom of the part through the solder joints and through a portion of the board. The board temperature is measured a specified distance from the package, using a two-sided, two-layer board. This board is described in JESD 51-9.

Given these definitions, it should now be apparent that none of these thermal coefficients reflects an actual physical operating condition of a μ Module converter. Thus, none of them can be individually used to accurately predict the thermal performance of the product. Likewise, it would be inappropriate to attempt to use any one coefficient to

correlate to the junction temperature vs load graphs given in the product's data sheet. The only appropriate way to use the coefficients is when running a detailed thermal analysis, such as FEA, which considers all of the thermal resistances simultaneously.

A graphical representation of these thermal resistances is given in Figure 3.

The blue resistances are contained within the μ Module converter, and the green are outside.

The die temperature of the LTM8048 must be lower than the maximum rating of 125°C, so care should be taken in the layout of the circuit to ensure good heat sinking of the LTM8048. The bulk of the heat flow out of the LTM8048 is through the bottom of the module and the BGA pads into the printed circuit board. Consequently a poor printed circuit board design can cause excessive heating, resulting in impaired performance or reliability. Please refer to the PCB Layout section for printed circuit board design suggestions.

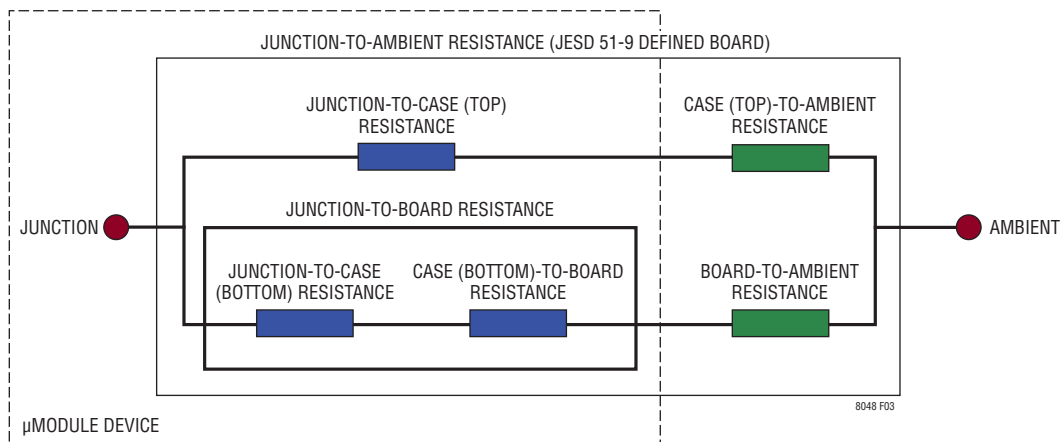
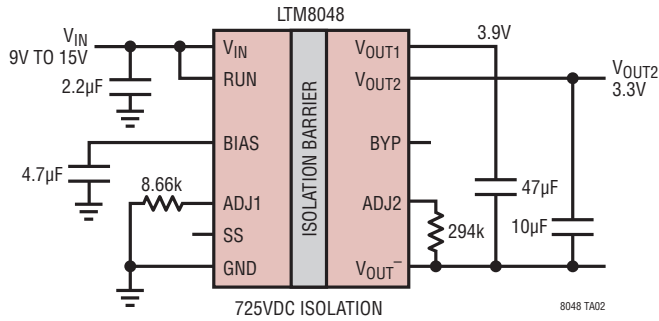

Figure 3.

TYPICAL APPLICATIONS

3.3V Flyback Converter



V_{OUT2} Output Current vs V_{IN}

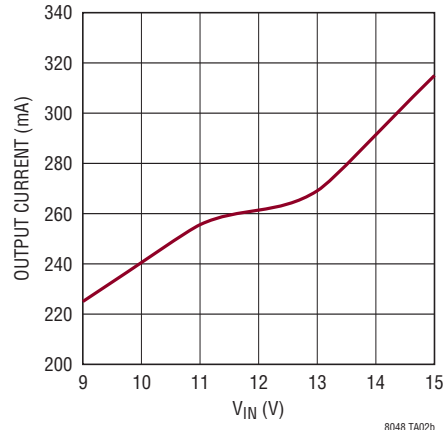

12V Flyback Converter with Low Noise Bypass

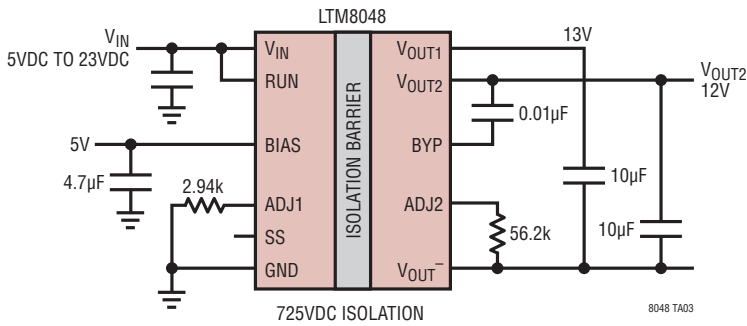

V_{OUT2} Output Current vs V_{IN}

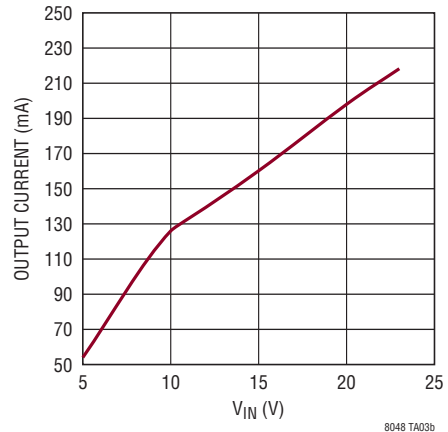

3.3V and 2.5V Flyback Converter

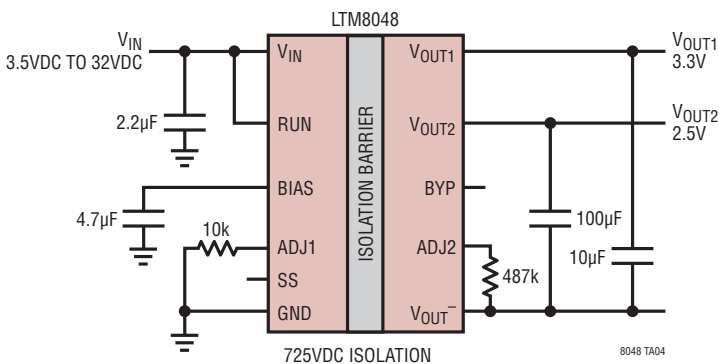

Total Output Current vs V_{IN}

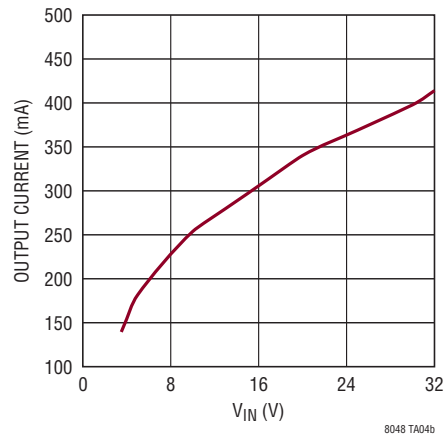

PACKAGE DESCRIPTION

Pin Assignment Table
(Arranged by Pin Number)

| PIN | FUNCTION | PIN | FUNCTION | PIN | FUNCTION | PIN | FUNCTION | PIN | FUNCTION | PIN | FUNCTION | PIN | FUNCTION |
|-----|-------------------|-----|-------------------|-----|-------------------|-----|----------|-----|----------|-----|----------|-----|-----------------|
| A1 | V _{OUT2} | B1 | V _{OUT2} | C1 | V _{OUT2} | D1 | - | E1 | GND | F1 | - | G1 | V _{IN} |
| A2 | ADJ2 | B2 | BYP | C2 | V _{OUT2} | D2 | - | E2 | GND | F2 | - | G2 | V _{IN} |
| A3 | V _{OUT-} | B3 | V _{OUT-} | C3 | V _{OUT-} | D3 | - | E3 | GND | F3 | RUN | G3 | - |
| A4 | V _{OUT-} | B4 | V _{OUT-} | C4 | V _{OUT-} | D4 | - | E4 | GND | F4 | GND | G4 | GND |
| A5 | V _{OUT-} | B5 | V _{OUT-} | C5 | V _{OUT-} | D5 | - | E5 | GND | F5 | GND | G5 | GND |
| A6 | V _{OUT1} | B6 | V _{OUT1} | C6 | V _{OUT1} | D6 | - | E6 | GND | F6 | GND | G6 | GND |
| A7 | V _{OUT1} | B7 | V _{OUT1} | C7 | V _{OUT1} | D7 | - | E7 | GND | F7 | GND | G7 | ADJ1 |
| | | | | | | | | | | | | H1 | V _{IN} |
| | | | | | | | | | | | | H2 | V _{IN} |
| | | | | | | | | | | | | H3 | - |
| | | | | | | | | | | | | H4 | GND |
| | | | | | | | | | | | | H5 | BIAS |
| | | | | | | | | | | | | H6 | SS |
| | | | | | | | | | | | | H7 | GND |

PACKAGE PHOTO

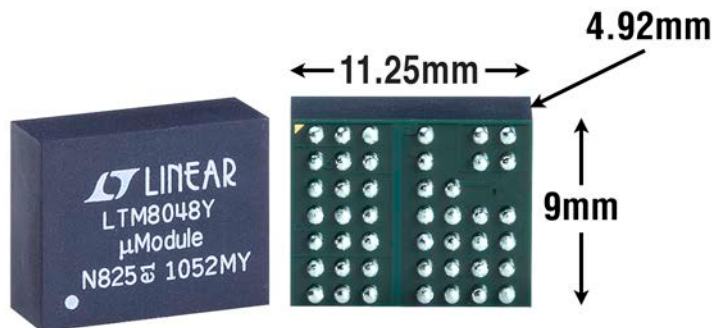

PACKAGE DESCRIPTION

Please refer to <http://www.linear.com/designtools/packages/> for the most recent package drawings.

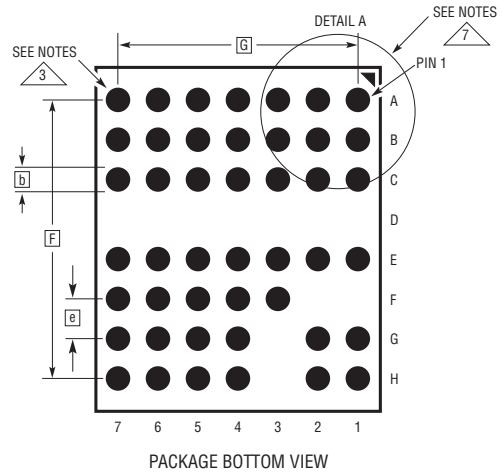

NOTES:

1. DIMENSIONING AND TOLERANCING PER ASME Y14.5M-1994
2. ALL DIMENSIONS ARE IN MILLIMETERS
- 3 BALL DESIGNATION PER JESD MS-028 AND JEP95
- 4 DETAILS OF PIN #1 IDENTIFIER ARE OPTIONAL, BUT MUST BE LOCATED WITHIN THE ZONE INDICATED. THE PIN #1 IDENTIFIER MAY BE EITHER A MOLD OR MARKED FEATURE
5. PRIMARY DATUM -Z- IS SEATING PLANE
6. SOLDER BALL COMPOSITION IS 96.5% Sn/3.0% Ag/0.5% Cu

7 PACKAGE ROW AND COLUMN LABELING MAY VARY AMONG μModule PRODUCTS. REVIEW EACH PACKAGE LAYOUT CAREFULLY

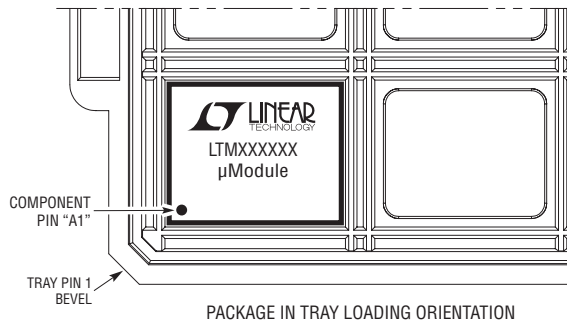

BGA 45 1212 REV A

BGA Package
45-Lead (11.25mm × 9.00mm × 4.92mm)
 (Reference LTC DWG # 05-08-1869 Rev A)

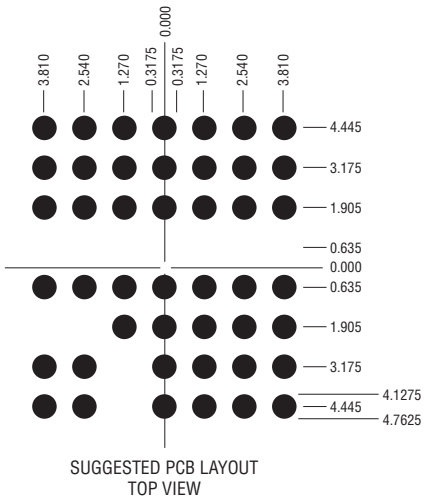
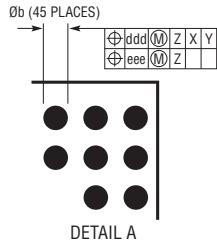
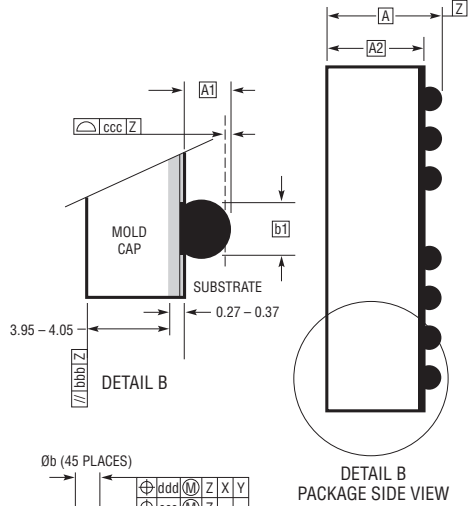
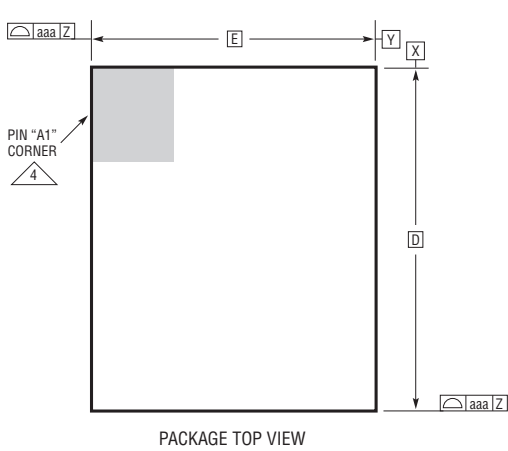

| DIMENSIONS | | | | |
|---------------------------|------|-------|------|-------|
| SYMBOL | MIN | NOM | MAX | NOTES |
| A | 4.72 | 4.92 | 5.12 | |
| A1 | 0.50 | 0.60 | 0.70 | |
| A2 | 4.22 | 4.32 | 4.42 | |
| b | 0.71 | 0.78 | 0.85 | |
| b1 | 0.60 | 0.63 | 0.66 | |
| D | | 11.25 | | |
| E | | 9.0 | | |
| e | | 1.27 | | |
| F | | 8.89 | | |
| G | | 7.62 | | |
| aaa | | | 0.15 | |
| bbb | | | 0.10 | |
| ccc | | | 0.20 | |
| ddd | | | 0.30 | |
| eee | | | 0.15 | |
| TOTAL NUMBER OF BALLS: 45 | | | | |

REVISION HISTORY

| REV | DATE | DESCRIPTION | PAGE NUMBER |
|-----|------|-------------------------------------------------------------------------------|-------------|
| A | 6/12 | Added storage temperature range. | 2 |
| | | Clarify V_{OUT2} and ADJ1 pin function description. | 8 |
| | | Clarify R_{ADJ2} equation. | 13 |
| | | Updated Related Parts table. | 20 |
| B | 8/12 | Add Safety Rated Capacitors section. | 12 |
| C | 9/12 | Correct Pin Assignment Table. | 17 |
| D | 3/13 | Updated Typical Application schematic. | 1 |
| | | Added Operating Conditions to Output Ripple graph. | 5 |
| | | Updated Related Parts table. | 20 |
| E | 1/14 | Revised R_{ADJ1} value for $5V_{OUT}$ and added minimum and maximum limits. | 3 |
| | | Revised R_{ADJ1} value for $5V_{OUT}$ in Table 1a. | 10 |
| F | 1/14 | Added SnPb Terminal Finish Option. | 1, 2 |
| G | 7/15 | Added ADJ and Line Regulation discussion. | 12 |

TYPICAL APPLICATION

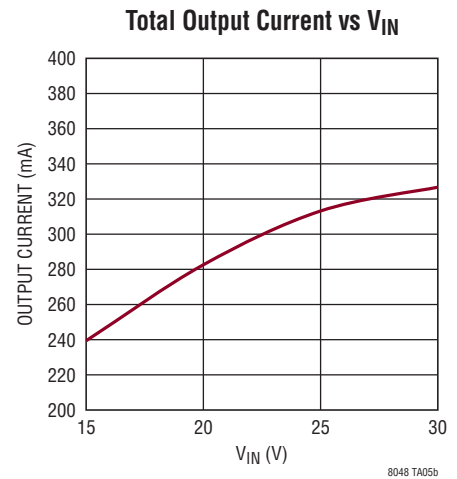
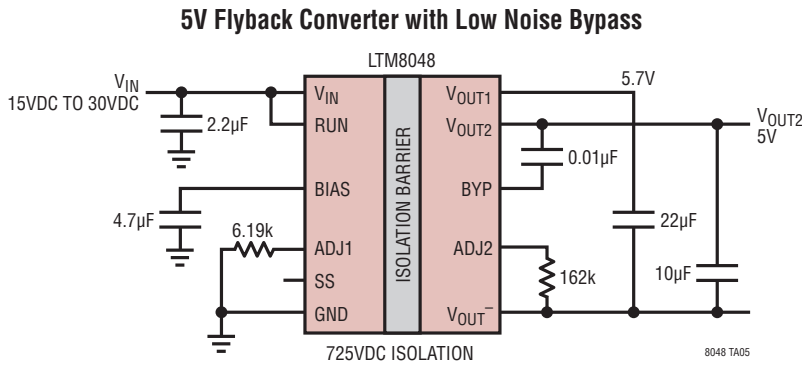

RELATED PARTS

| PART NUMBER | DESCRIPTION | COMMENTS |
|-------------------------|------------------------------------------------|-------------------------------------------------------------------------------------------------------------------------|
| LTM8031 | Ultralow EMI 1A μ Module Regulator | EN55022 Class B Compliant, $3.6V \leq V_{IN} \leq 36V$; $0.8V \leq V_{OUT} \leq 10V$ |
| LTM8032 | Ultralow EMI 2A μ Module Regulator | EN55022 Class B Compliant, $3.6V \leq V_{IN} \leq 36V$; $0.8V \leq V_{OUT} \leq 10V$ |
| LTM8033 | Ultralow EMI 3A μ Module Regulator | EN55022 Class B Compliant, $3.6V \leq V_{IN} \leq 36V$; $0.8V \leq V_{OUT} \leq 24V$ |
| LTM4612 | Ultralow EMI 5A μ Module Regulator | EN55022 Class B Compliant, $5V \leq V_{IN} \leq 36V$; $3.3V \leq V_{OUT} \leq 15V$ |
| LTM8061 | Li-Ion/Polymer μ Module Battery Charger | $4.95V \leq V_{IN} \leq 32V$, 2A Charge Current, 1-Cell and 2-Cell, 4.1V or 4.2V per Cell |
| LTM4613 | Ultralow EMI 8A μ Module Regulator | EN55022 Class B Compliant, $5V \leq V_{IN} \leq 36V$; $3.3V \leq V_{OUT} \leq 15V$ |
| LTM8047 | 725VDC Isolated μ Module Converter | $3.1V \leq V_{IN} \leq 32V$; $2.5V \leq V_{OUT} \leq 12V$ |
| LTC2978 | Octal Digital Power Supply Manager with EEPROM | I^2C /PMBus Interface, Configuration EEPROM, Fault Logging, 16-Bit ADC with $\pm 0.25\%$ TUE, 3.3V to 15V Operation |
| LTC2974 | Quad Digital Power Supply Manager with EEPROM | I^2C /PMBus Interface, Configuration EEPROM, Fault Logging, Per Channel Voltage, Current and Temperature Measurements |