



Chipsmall Limited consists of a professional team with an average of over 10 year of expertise in the distribution of electronic components. Based in Hongkong, we have already established firm and mutual-benefit business relationships with customers from,Europe,America and south Asia,supplying obsolete and hard-to-find components to meet their specific needs.

With the principle of “Quality Parts,Customers Priority,Honest Operation,and Considerate Service”,our business mainly focus on the distribution of electronic components. Line cards we deal with include Microchip,ALPS,ROHM,Xilinx,Pulse,ON,Everlight and Freescale. Main products comprise IC,Modules,Potentiometer,IC Socket,Relay,Connector.Our parts cover such applications as commercial,industrial, and automotives areas.

We are looking forward to setting up business relationship with you and hope to provide you with the best service and solution. Let us make a better world for our industry!



Contact us

Tel: +86-755-8981 8866 Fax: +86-755-8427 6832

Email & Skype: info@chipsmall.com Web: www.chipsmall.com

Address: A1208, Overseas Decoration Building, #122 Zhenhua RD., Futian, Shenzhen, China





LED Display Product Data Sheet LTP-14858AA

Spec No.: DS-30-98-237

Effective Date: 01/09/2001

Revision: -

LITE-ON DCC

RELEASE

BNS-OD-FC001/A4

FEATURES

- * 1.4 inch (35.76 mm) MATRIX HEIGHT.
- * LOW POWER REQUIREMENT.
- * SINGLE PLANE, WIDE VIEWING ANGLE
- * SOLID STATE RELIABILITY.
- * 5x8 ARRAY WITH X-Y SELECT.
- * COMPATIBLE WITH USASCLL AND EBCDIC CODES.
- * STACKABLE HORIZONTALLY.
- * CATEGORIZED FOR LUMINOUS INTENSITY.

DESCRIPTION

The LTP-14858AA is a 1.4 inch (35.76 mm) height dot matrix display. This device is multicolor applicable display, which has gray face and white dot color. The red orange LED chips are made from GaAsP on a transparent GaP substrate. The green LED chips are made from GaP on a transparent GaP substrate.

DEVICE

PART NO.	DESCRIPTION
Red Orange & Green	Anode Column
LTP-14858AA	Cathode Row

PACKAGE DIMENSIONS

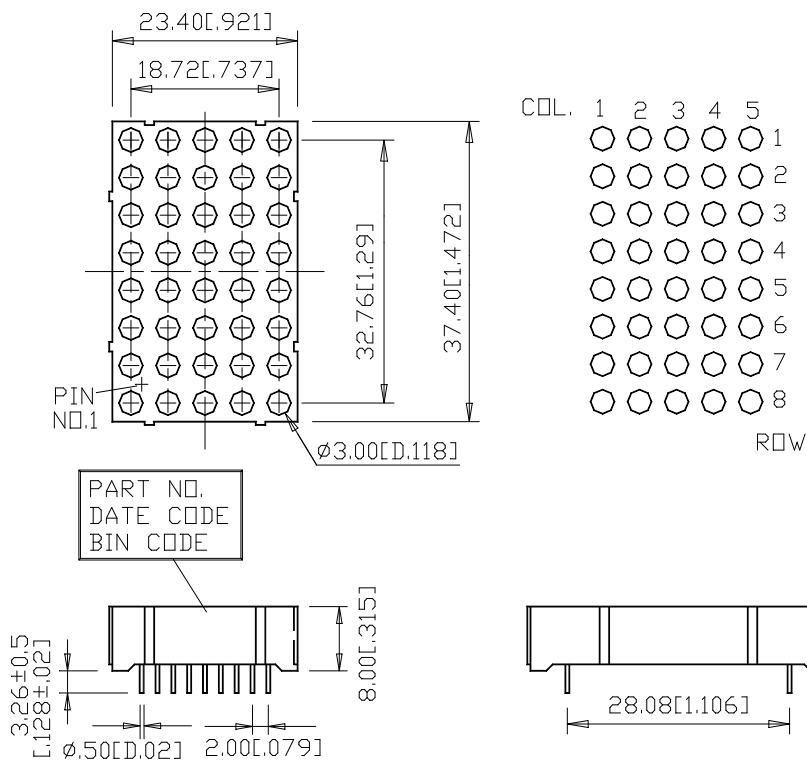

NOTES: All dimensions are in millimeters. Tolerances are ± 0.25 mm (0.01") unless otherwise noted.

INTERNAL CIRCUIT DIAGRAM

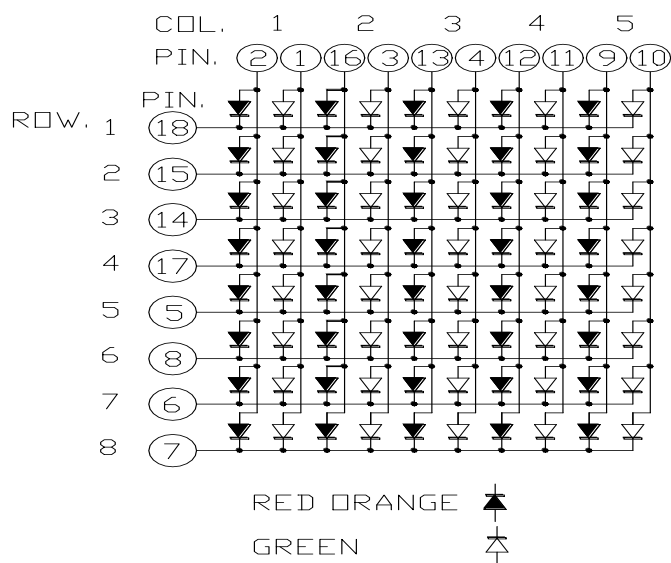

PIN CONNECTION

No.	CONNECTION
1	ANODE COLUMN 1 (GREEN)
2	ANODE COLUMN 1 (RED ORANGE)
3	ANODE COLUMN 2 (GREEN)
4	ANODE COLUMN 3 (GREEN)
5	CATHODE ROW 5
6	CATHODE ROW 7
7	CATHODE ROW 8
8	CATHODE ROW 6
9	ANODE COLUMN 5 (RED ORANGE)
10	ANODE COLUMN 5 (GREEN)
11	ANODE COLUMN 4 (GREEN)
12	ANODE COLUMN 4 (RED ORANGE)
13	ANODE COLUMN 3 (RED ORANGE)
14	CATHODE ROW 3
15	CATHODE ROW 2
16	ANODE COLUMN 2 (RED ORANGE)
17	CATHODE ROW 4
18	CATHODE ROW 1

ABSOLUTE MAXIMUM RATING AT T_A=25°C

PARAMETER	GREEN	RED ORANGE	UNIT
Average Power Dissipation Per Dot	36		mW
Peak Forward Current Per Dot	100		mA
Average Forward Current Per Dot	13		mA
Derating Linear From 25°C Per Dot	0.17		mA/°C
Reverse Voltage Per Dot	5		V
Operating Temperature Range	-35°C to +85°C		
Storage Temperature Range	-35°C to +85°C		
Solder Temperature 1/16 inch Below Seating Plane for 3 Seconds at 260°C			

ELECTRICAL / OPTICAL CHARACTERISTICS AT T_A=25°C

GREEN

PARAMETER	SYMBOL	MIN.	TYP.	MAX.	UNIT	TEST CONDITION
Average Luminous Intensity	I _v	1780	4800		μcd	I _p =80mA 1/16DUTY
Peak Emission Wavelength	λ _p		565		nm	I _F =20mA
Spectral Line Half-Width	Δλ		30		nm	I _F =20mA
Dominant Wavelength	λ _d		569		nm	I _F =20mA
Forward Voltage any Dot	V _F		2.1	2.6	V	I _F =20mA
			3	3.7	V	I _F =80mA
Reverse Current any Dot	I _R			100	μA	V _R =5V
Luminous Intensity Matching Ratio	I _v -m			2:1		I _p =80mA 1/16DUTY

RED ORANGE

PARAMETER	SYMBOL	MIN.	TYP.	MAX.	UNIT	TEST CONDITION
Average Luminous Intensity	I _v	1780	4800		μcd	I _p =80mA 1/16DUTY
Peak Emission Wavelength	λ _p		630		nm	I _F =20mA
Spectral Line Half-Width	Δλ		40		nm	I _F =20mA
Dominant Wavelength	λ _d		621		nm	I _F =20mA
Forward Voltage any Dot	V _F		2	2.6	V	I _F =20mA
			2.6	3.4	V	I _F =80mA
Reverse Current any Dot	I _R			100	μA	V _R =5V
Luminous Intensity Matching Ratio	I _v -m			2:1		I _p =80mA 1/16DUTY

Note: Luminous intensity is measured with a light sensor and filter combination that approximates the CIE (Commision Internationale De L'Eclairage) eye-response curve.

TYPICAL ELECTRICAL / OPTICAL CHARACTERISTIC CURVES

(25°C Ambient Temperature Unless Otherwise Noted)

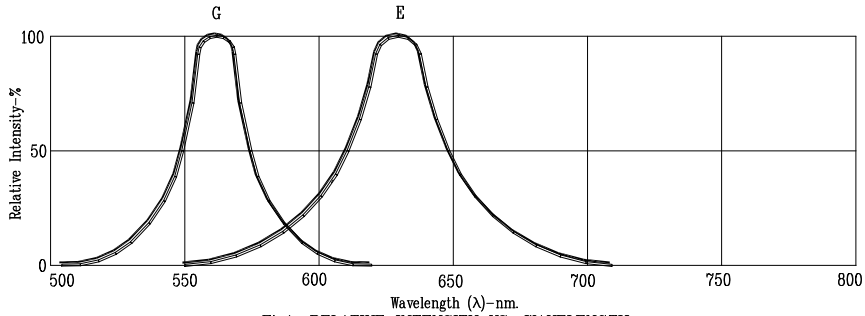

Fig1. RELATIVE INTENSITY VS. WAVELENGTH

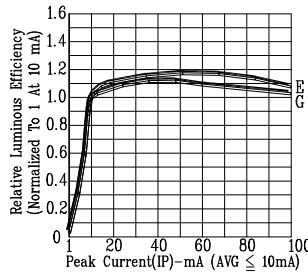

Fig2. RELATIVE LUMINOUS EFFICIENCY (LUMINOUS INTENSITY PER UNIT CURRENT) VS. PEAK CURRENT (REFRESH RATE 1KHz)

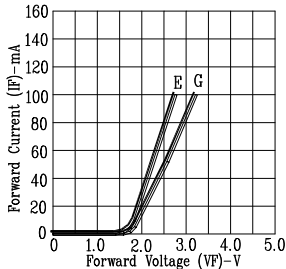

Fig3. FORWARD CURRENT VS. FORWARD VOLTAGE

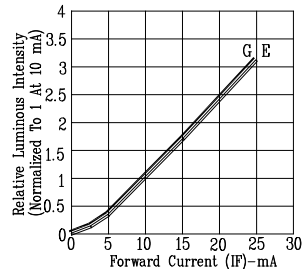

Fig4. RELATIVE LUMINOUS INTENSITY VS. FORWARD CURRENT

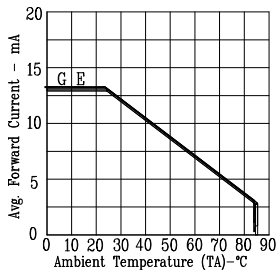

Fig5. MAX AVERAGE FORWARD CURRENT VS. AMBIENT TEMPERATURE.

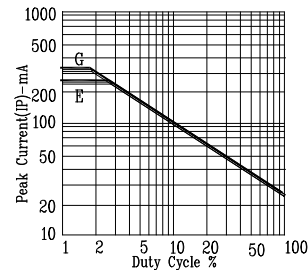

Fig6. MAX PEAK CURRENT VS. DUTY CYCLE % (REFRESH RATE 1KHz)

NOTE: G=GREEN & E=RED ORANGE