



Chipsmall Limited consists of a professional team with an average of over 10 year of expertise in the distribution of electronic components. Based in Hongkong, we have already established firm and mutual-benefit business relationships with customers from,Europe,America and south Asia,supplying obsolete and hard-to-find components to meet their specific needs.

With the principle of "Quality Parts,Customers Priority,Honest Operation,and Considerate Service",our business mainly focus on the distribution of electronic components. Line cards we deal with include Microchip,ALPS,ROHM,Xilinx,Pulse,ON,Everlight and Freescale. Main products comprise IC,Modules,Potentiometer,IC Socket,Relay,Connector.Our parts cover such applications as commercial,industrial, and automotives areas.

We are looking forward to setting up business relationship with you and hope to provide you with the best service and solution. Let us make a better world for our industry!



Contact us

Tel: +86-755-8981 8866 Fax: +86-755-8427 6832

Email & Skype: info@chipsmall.com Web: www.chipsmall.com

Address: A1208, Overseas Decoration Building, #122 Zhenhua RD., Futian, Shenzhen, China



LIGHT LED M09 CoB Product Series

1. Description

The LiteON CoB Product series is a revolutionary, energy efficient and ultra-compact new light source, combining the lifetime and reliability advantages of Light Emitting Diodes with the brightness of conventional lighting. It gives you total design freedom and unmatched brightness, creating a new opportunities for solid state lighting to displace conventional lighting technologies.

1.1 Features

- Compact high flux density light source
- Uniform high quality illumination
- Streamlined thermal path
- MacAdam compliant binning structure
More energy efficient than incandescent, halogen and fluorescent lamps
- Instant light with unlimited dimming
- RoHS compliant and Pb free

1.2 Benefits Features

- Enhanced optical control
- Clean white light without pixilation
- Uniform consistent white light
- Significantly reduced thermal resistance and increased operating temperatures
- Lower operating costs
- Reduced maintenance costs
- ESD rating is 8KV in HBM

1.3 Naming Rule

L T PL - M 0 9 8 X X X S X X - T 0
Code1 Code2 Code3 Code4 Code5 Code6 Code7

Code 1: Product Line

PL: High Power LED.

Code 2: Package Type/Platform

M09: Ceramic substrate with 18x18mm square.

Code 3: Light Emitting Surface

8: 12.6mm excluding dam

Code 4: Product Series

30: 30 Series

Code5: CRI

Z: White Color Rendering Index 80 min

Q: White Color Rendering Index 90 min

Code6: Color Temperature

30: 3000K at 85degC

40: 4000K at 85degC

50: 5000K at 85degC

Note: The Color Temperature follow ANSI C78.377A Doc.

Code7: Hue Bin by MacAdam Ellipses Step

T0: MacAdam Ellipse / ANSI BIN

**LIGHT LED
M09 CoB Product Series**

1.4 Product List

Part Number	Product Series	CCT	CRI	Color Bin			Lumen Bin	
				3SDCM	5SDCM	ANSI	-8%~+8%	-15%~+15%
LTPL-M09830ZS30-T0	30	3000K	80	☆	☆	☆	☆	☆
LTPL-M09830ZS40-T0	30	4000K	80	☆	☆	☆	☆	☆
LTPL-M09830ZS50-F1	30	5000K	80		☆	☆		☆
LTPL-M09830QS30-T0	30	3000K	90	☆	☆	☆	☆	☆

Preliminary

LIGHT LED M09 CoB Product Series

2. Outline Dimensions

2.1 Form Factor of M098 series CoB

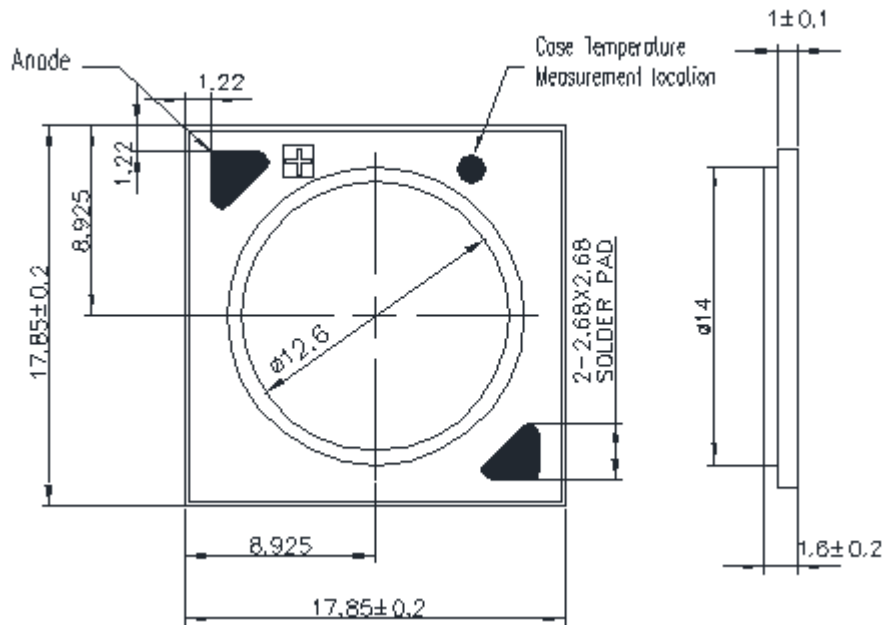

Notes

1. All dimensions are in millimeters.
2. Tolerance is ± 0.3 mm unless otherwise noted.
3. LED of equivalent circuit means all series/parallel in CoB package.

2.2 Internal Equivalent Circuit

30 Series Product

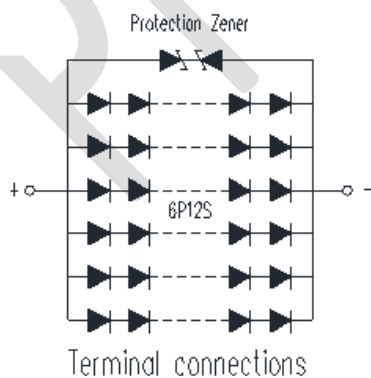

LIGHT LED M09 CoB Product Series

3. Absolute Maximum Ratings at Ta=25°C

Parameter	Symbol	Product Series	Rating	Unit
Power Dissipation	P_O	30	49	W
Forward Current	I_F	30	1200	mA
Junction Temperature		T_j	125	°C
Thermal Resistance, Junction-Case	$R_{th, J-C}$	30	0.76	°C/W
Operating Temperature Range		T_{opr}	-40 to 85	°C
Storage Temperature Range		T_{stg}	-40 to 100	°C
Breakdown Voltage(DC)		V_B	2.25	KV
Electrostatic Discharge		ESD	8	KV

Notes

1. The pulse mode condition is 1/10 duty cycle with 100 msec pulse width.
2. Forbid to be operated at reverse voltage condition.
3. ESD spec is reference to AEC-Q101-001 HBM.
4. The unit of R_{th} is °C/W electrical.
5. The M09 CoB is recommended soldering temperature under 350degC and could not over 3.5sec.

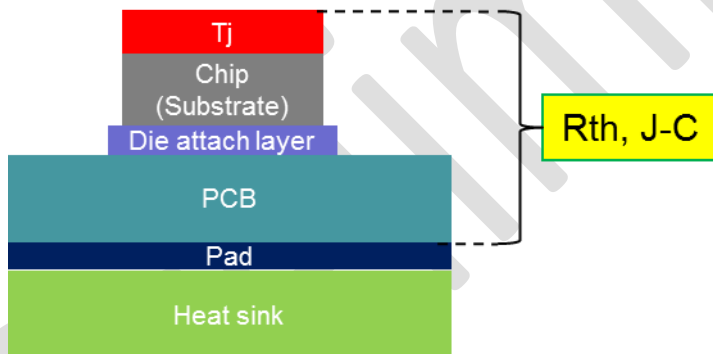

LIGHT LED M09 CoB Product Series

4. Electro-Optical Characteristics

4.1 Typical Performance

■ 30 Series Product, CRI>80

Dominant CCT	Product Series	Current (mA)	V _F (V) @25°C	Flux(lm) @25°C	V _F (V) @85°C	Flux(lm) @85°C	Eff.(lm/W) @25°C	Eff.(lm/W) @85°C
3000K	30	800	36.8	3971	35.5	3496	135	123
4000K	30	800	36.8	4209	35.5	3705	143	130
5000K	30	800	36.8	4248	35.5	3740	145	132

■ 30 Series Product, CRI>90

Dominant CCT	Product Series	Current (mA)	V _F (V) @25°C	Flux(lm) @25°C	V _F (V) @85°C	Flux(lm) @85°C	Eff.(lm/W) @25°C	Eff.(lm/W) @85°C
3000K	30	800	36.8	3256	35.5	2866	110	101

Notes

1. All of V_F value are typical, the real bin range please refer page 11 "V_F Binning Parameter".
2. All of flux value are typical, the real bin range please refer page 11 "Flux Binning Parameter".
3. Tolerance of flux is ±7%, tolerance of CCX/CCY is ±0.007, tolerance of CRI is ±2, and tolerance of V_F is ±3%.
4. Typical viewing angle is 120deg.

LIGHT LED M09 CoB Product Series

4.2 Forward Current vs. Lumen and Voltage

■ 30 Series Product

Current (mA)	V _F (V)	Flux (lm)			
		3000K	4000K	5000K	3000K
		CRI>80	CRI>80	CRI>80	CRI>90
500	34.5	2653	2812	2839	2175
600	35.3	3122	3309	3341	2560
700	35.9	3540	3752	3788	2903
800	36.7	3971	4209	4248	3256
900	37.6	4396	4660	4704	3605
1000	38.1	4798	5086	5134	3934
1100	38.8	5134	5442	5493	4210
1200	39.4	5458	5785	5840	4476

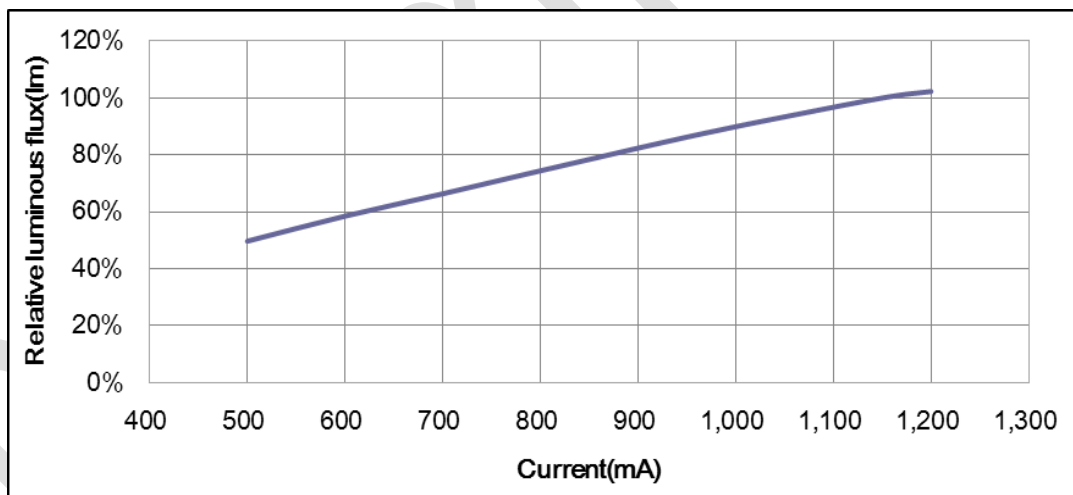

LIGHT LED M09 CoB Product Series

4.3 Relative Spectral Power Distribution at Typical Current

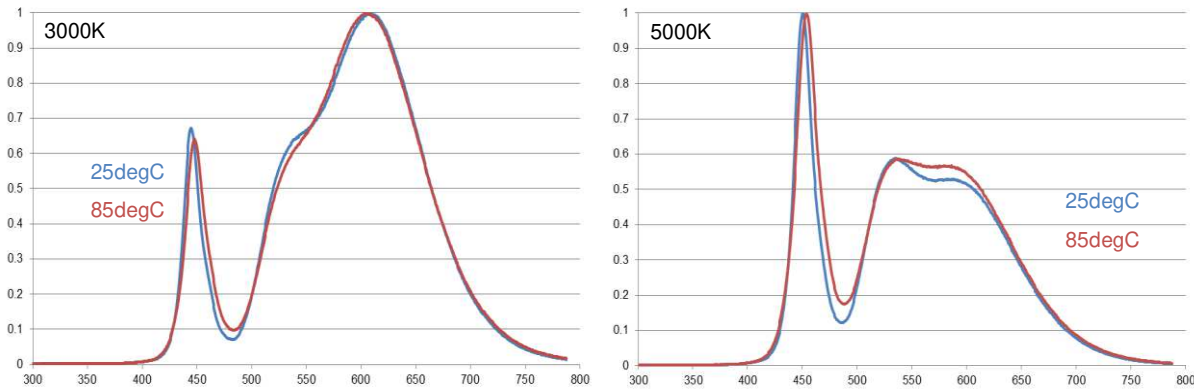

4.4 Radiation Characteristics

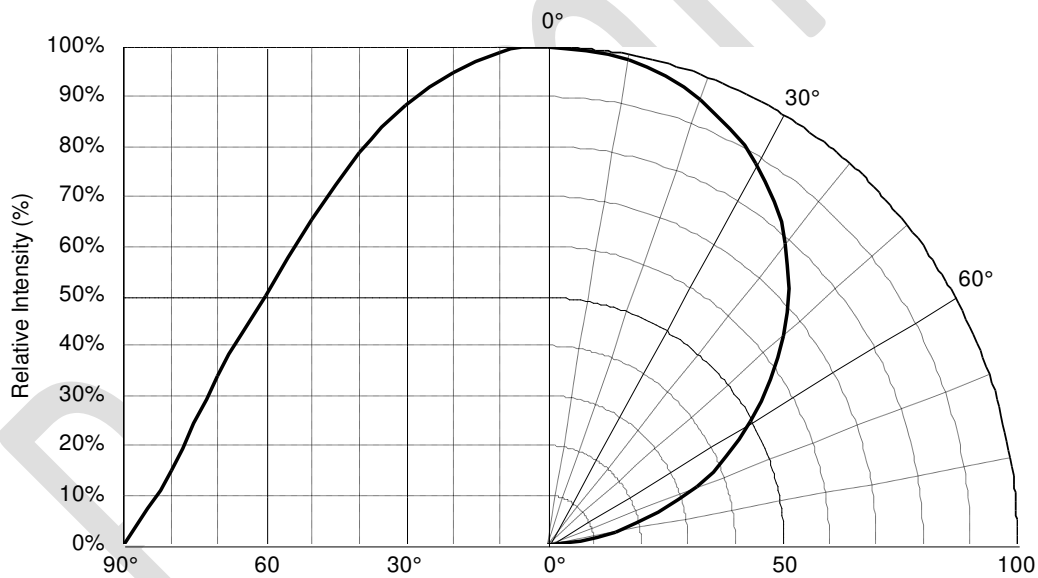

**LIGHT LED
M09 CoB Product Series**

4.5 Forward Current vs. Forward Voltage

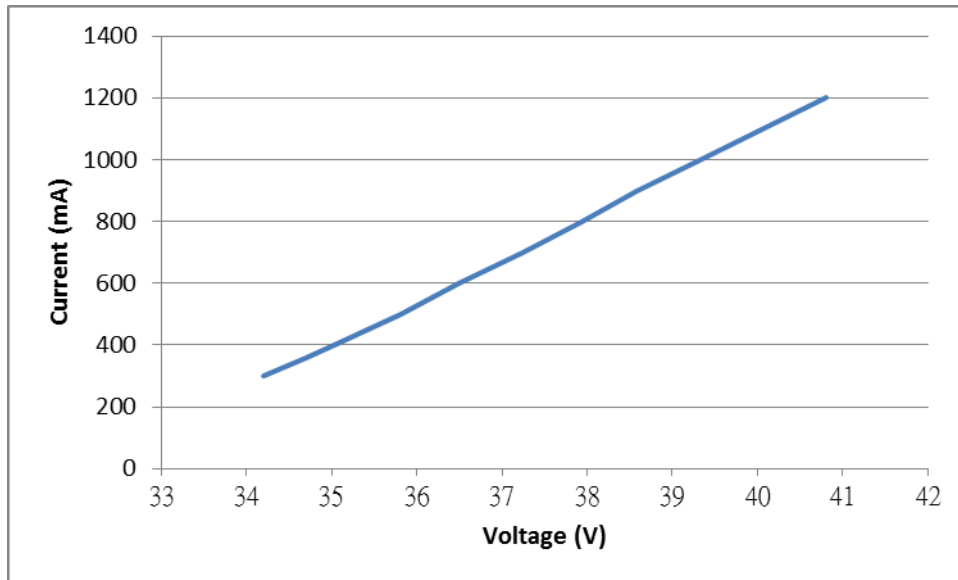

4.6 Forward Voltage vs. Case Temperature

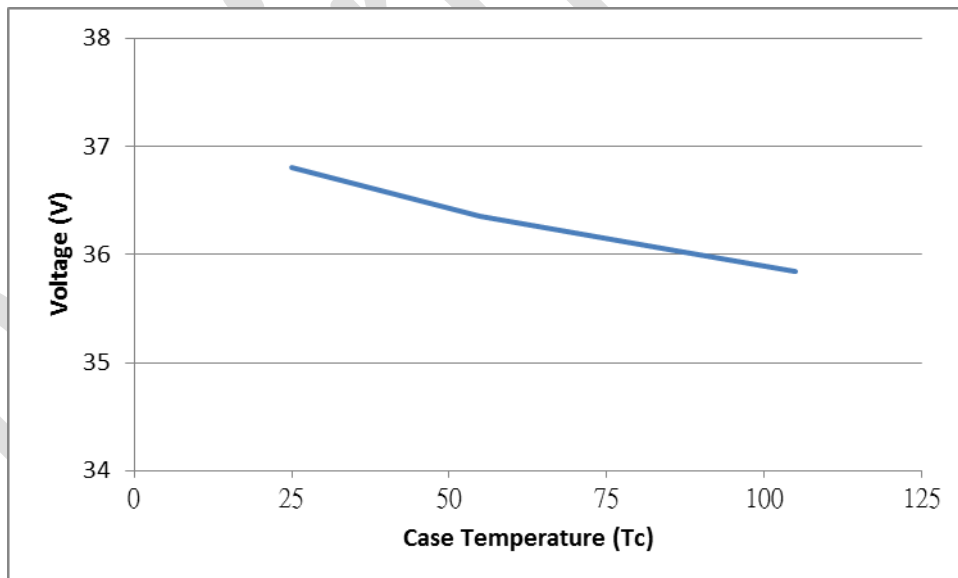

LIGHT LED M09 CoB Product Series

4.7 Relative Intensity vs. Case Temperature

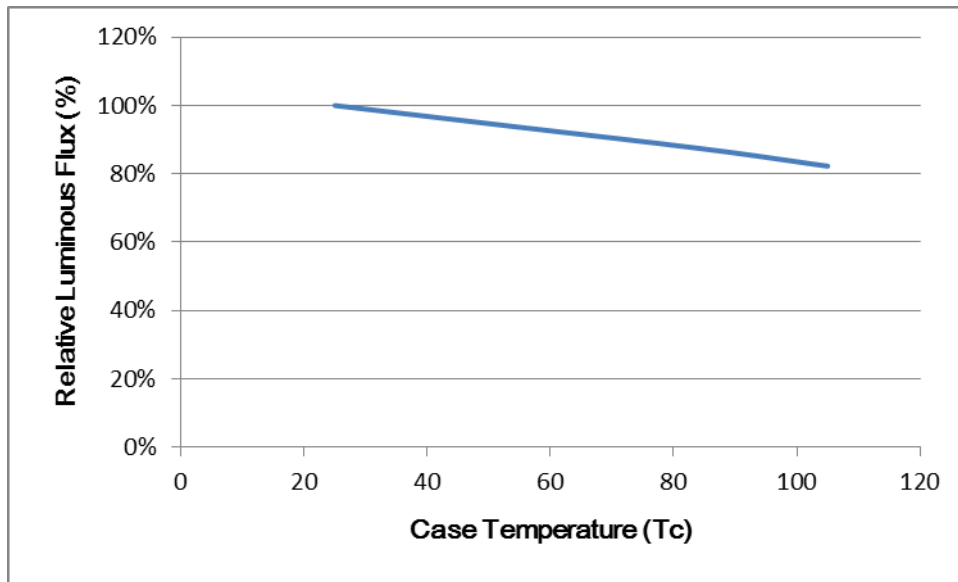

4.8 Forward Current Degrading Curve

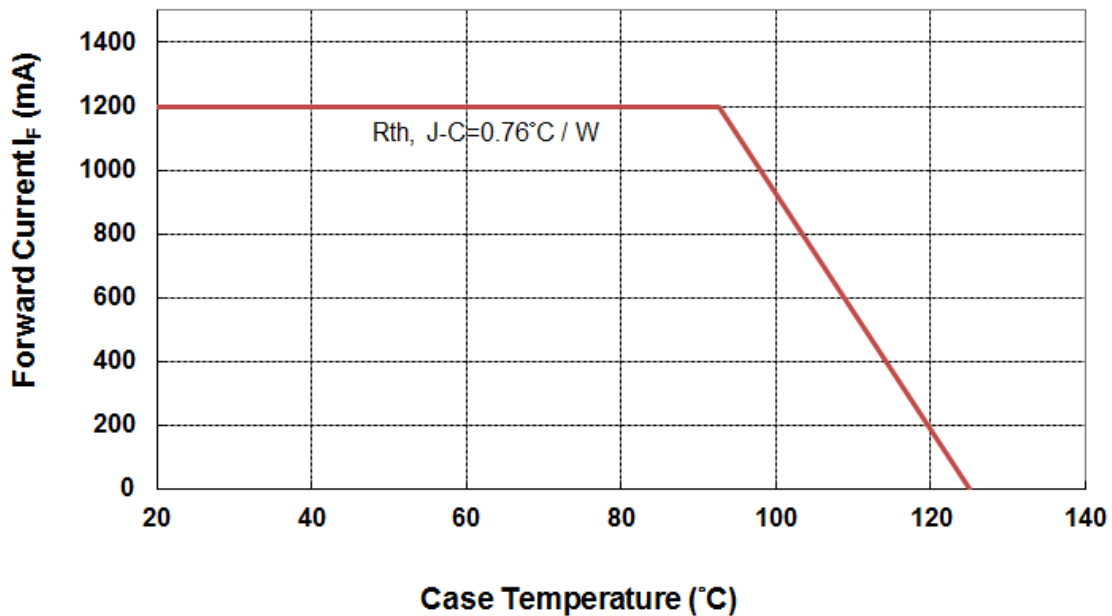

LIGHT LED M09 CoB Product Series

5. CoB Binning Definition

Flux Binning Parameter (25degC)

Lumen CODE List of M09 Series Product			
Parameter	Code	Unit	Lumen
Luminous Flux	D	lm	2300
	E		2485
	F		2680
	G		2890
	H		3120
	I		3370
	J		3640
	K		3925
	L		4240
	M		4575
	N		4940
	O		5330
	P		5755
Q	6210		

Example of M09 Series Product Bin (3000K 30 series)

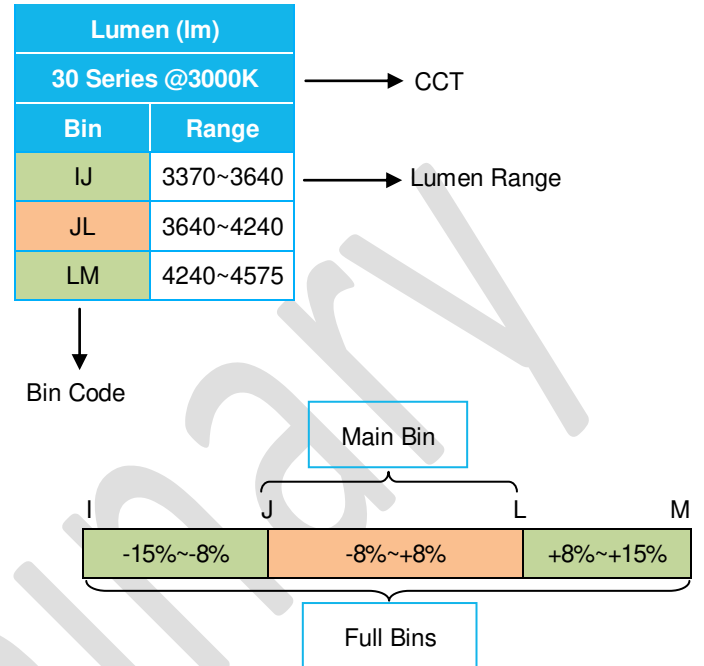

Lumen Bin

Lumen (lm)							
3000K (CRI>80)		4000K (CRI>80)		5000K (CRI>80)		3000K (CRI>90)	
Bin	Range	Bin	Range	Bin	Range	Bin	Range
IJ	3370~3640	IJ	3370~3640	JK	3640~3925	FG	2680~2890
JL	3640~4240	JL	3640~4240	KM	3925~4575	GI	2890~3370
LM	4240~4575	LM	4240~4575	MN	4575~4940	IJ	3370~3640

**LIGHT LED
M09 CoB Product Series**

■ Forward Voltage Binning Parameter (25degC)

Parameter	Bin	Symbol	Min	Max	Unit	Condition
Forward Voltage	V1	V _F	33.6	42	V	I _F =Typical current

Note: Full Rank on Label

Example: V1/JL/E1

Forward Voltage Rank	Luminous Flux Rank	Color Rank
V1	JL	E1

Preliminary

LIGHT LED M09 CoB Product Series

■ Example of LiteOn CoB MacAdam Ellipse Color Definition (Ex: 3000K)

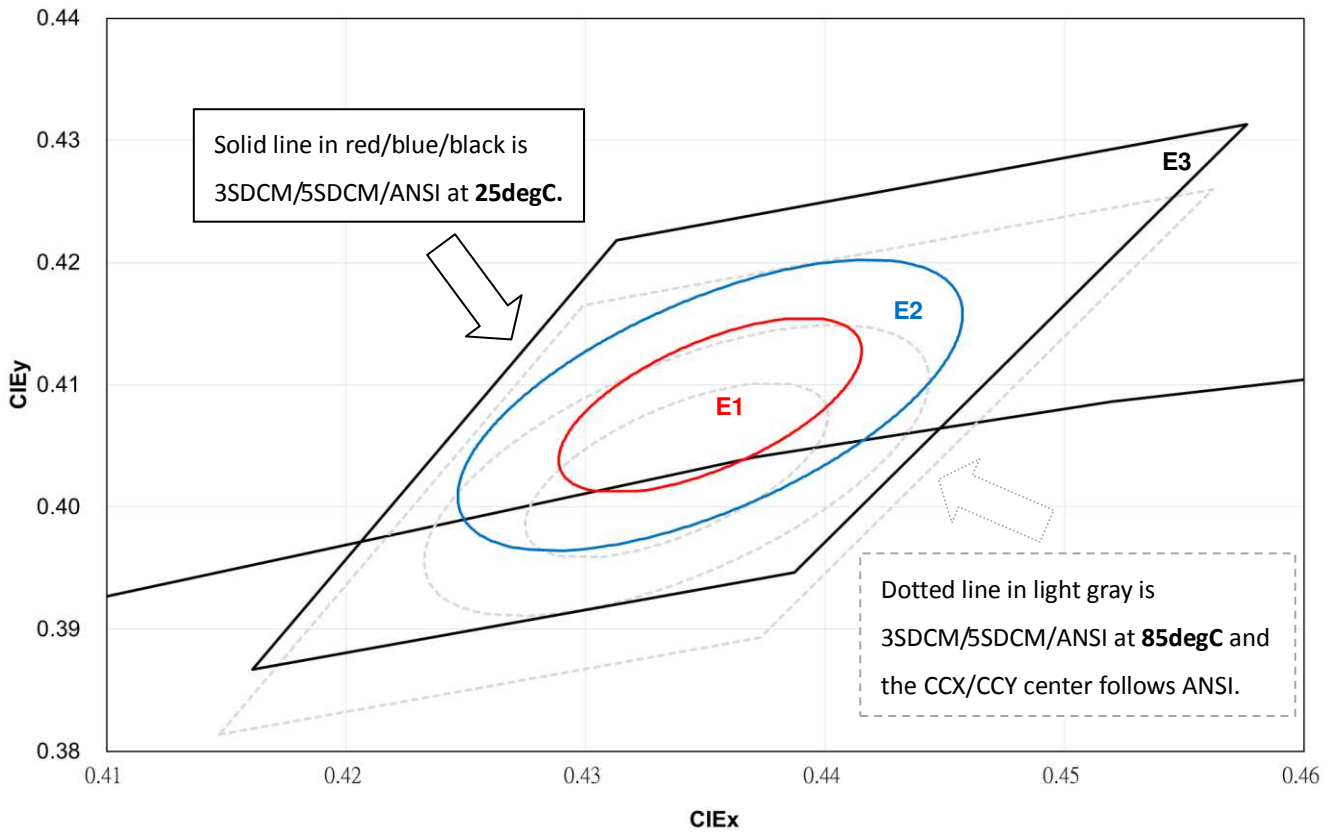

CIE Center Point						
CCT	25degC (LiteOn Spec.)		85degC (ANSI)		Hot/Cold Factor	
	CCX	CCY	CCX	CCY	CCX	CCY
3000	0.4392	0.4072	0.4338	0.4030	-0.0054	-0.0042
4000	0.3849	0.3856	0.3818	0.3797	-0.0031	-0.0059
5000	0.3486	0.3670	0.3447	0.3553	-0.0039	-0.0117

Notes

- LiteOn tester and shipping spec follow the color bin with 25degC CCX/CCY center.
- The Hot/Cold factor means the CCX/CCY shift from 25degC to 85degC.
- The Hot/Cold shift is measured by LiteOn CAS 140B instrument system.
- The ellipse equation expression: $SDCM = (g11*(x-x_0)^2 + 2*g12*(x-x_0)*(y-y_0) + g22*(y-y_0)^2)^{0.5}$

**LIGHT LED
M09 CoB Product Series**

- M09 CRI80、CRI90 3000K
PN: LTPL-M098xxxS30-T0

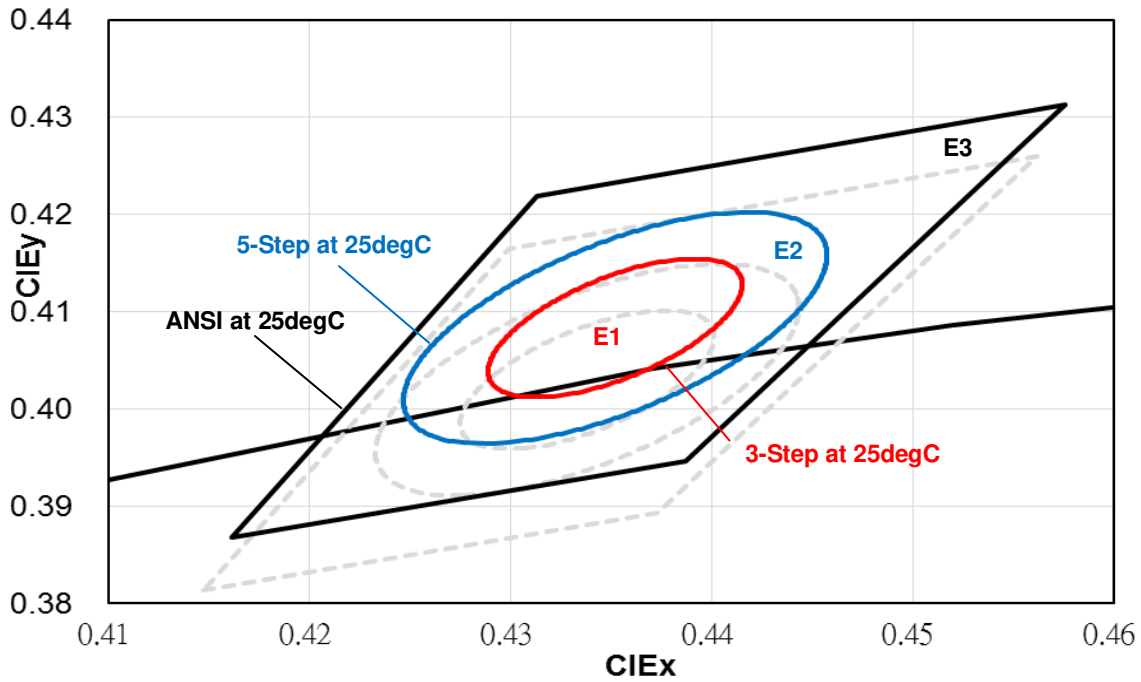

- M09 CRI80 4000K
PN: LTPL-M098xxZS40-T0

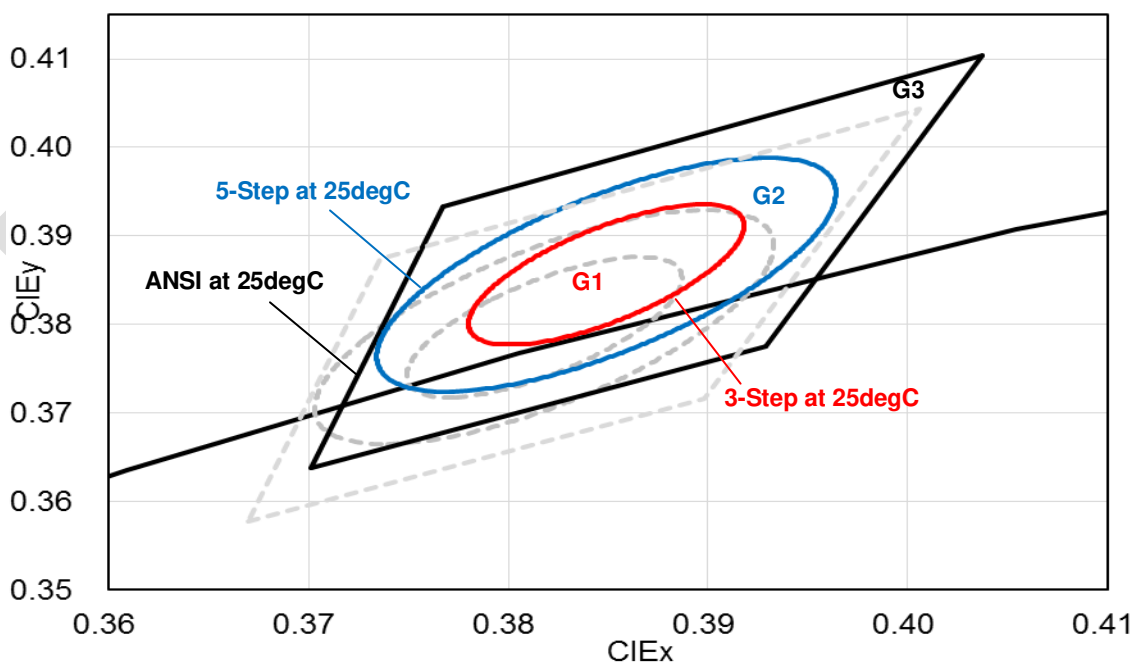

**LIGHT LED
M09 CoB Product Series**

■ M09 CRI80 5000K

PN: LTPL-M098xxZS50-F1

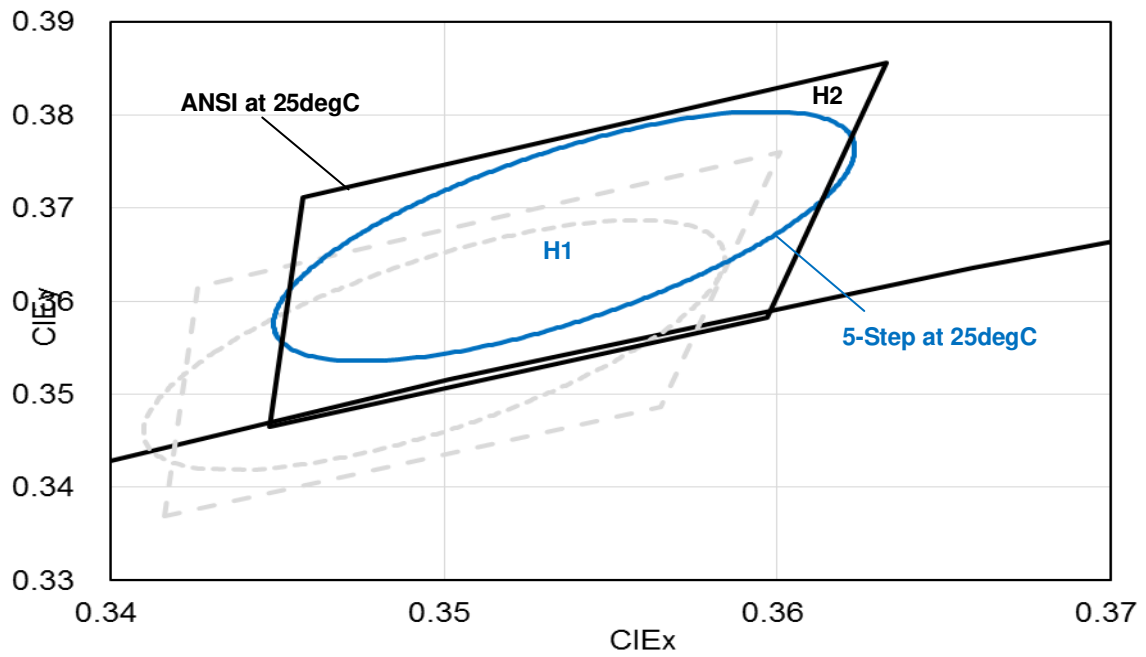

Preliminary

LIGHT LED M09 CoB Product Series

6. Reliability Test Plan

No	Test item	Condition	Duration	Number of Failed	Result
1	High Temperature Operating Life	Tc=85°C, I _F =Typical Current	1K hours	0/10	Pass
2	Wet High Temperature Operating Life	60°C/90%RH, I _F =Typical Current(DC) 30 mins ON/OFF	1K hours	0/10	Pass
3	Thermal Shock	-40°C to 125°C, 15minutes dwell, <10 seconds transfer, measurement in every 250 cycles	500 cycles	0/10	Pass
4	Fast Switch Cycling Test	40000cycles, 2 mins On/Off, Room temperature(25°C+/-5°C), measurement in every 5000 cycles	40K cycles	0/10	Pass
5	High Temperature Storage Life	Ta=120°C	1K hours	0/10	Pass
6	Low Temperature Storage Life	Ta=-55°C	1K hours	0/10	Pass
7	Mechanical Shock	1500G, 0.5ms pulse, 5 shocks each 6 axis	30 Times (5 shocks each 6 axis)	0/10	Pass
8	Variable Vibration Frequency	10-2000-10 Hz, log or linear sweep rate, 20G for approximately minute 1.5mm, each applied three times per axis over 6 hrs.	18 hrs (3 times per axis over 6 hrs)	0/10	Pass

■ Criteria for Judging the Damage

Item	Symbol	Test Condition	Criteria for Judgment	
			Min.	Max.
Forward Voltage	V _F	I _F =Typical Current		U.S.L. x 1.1
Luminous Flux	Lm	I _F =Typical Current	L.S.L. x 0.7	
CCX & CCY	X,Y	I _F =Typical Current		Shift<0.02

Notes

1. Operating life tests are mounted on thermal heat sink
2. Storage items are only component, not put on heat sink.

LIGHT LED M09 CoB Product Series

7. Packing Specifications

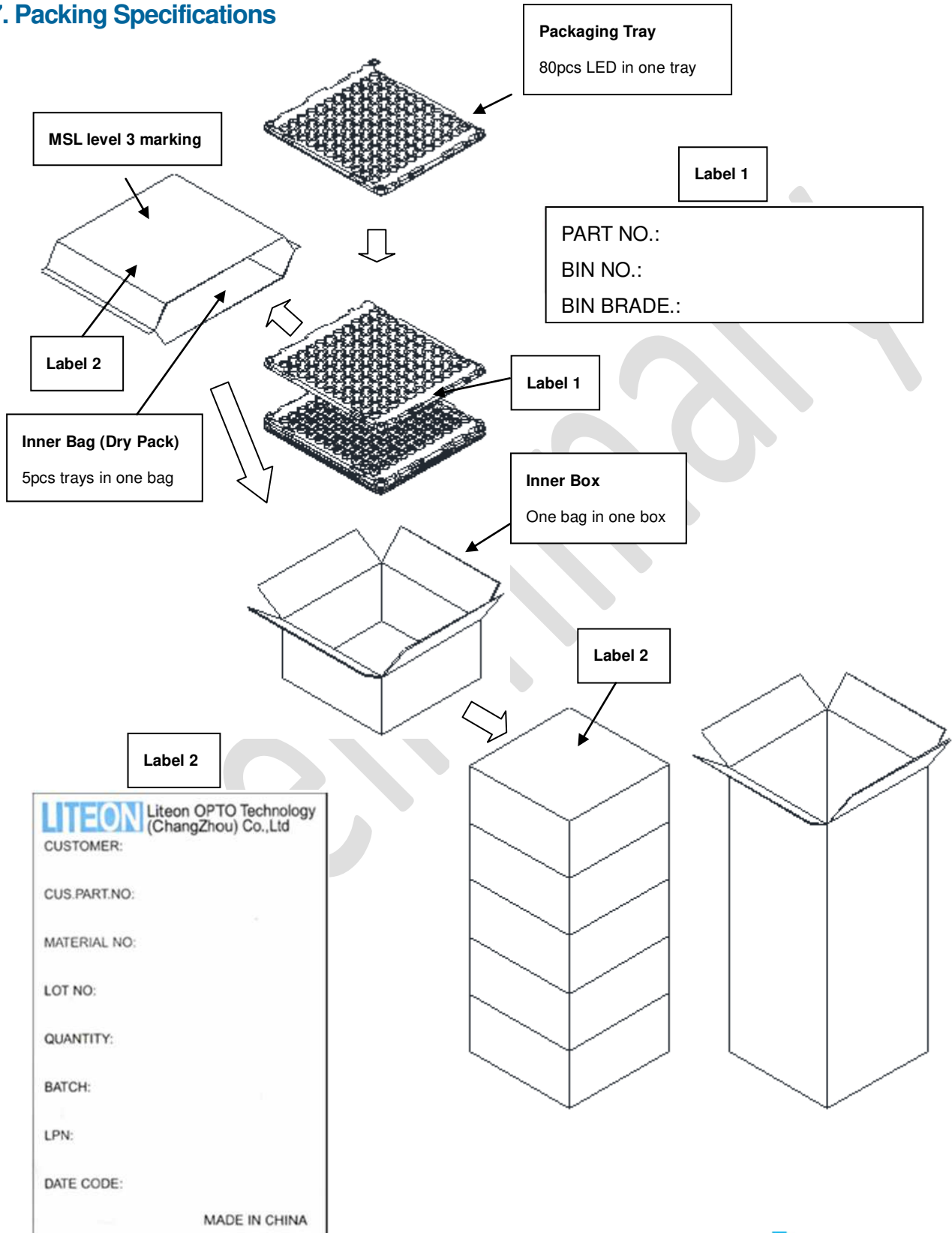

LIGHT LED M09 CoB Product Series

8. Cautions

7.1 An LED is a current-operated device. In order to ensure intensity uniformity on multiple LEDs connected in parallel in an application, it is recommended that a current limiting resistor be incorporated in the drive circuit, in series with each LED as shown in circuit below.

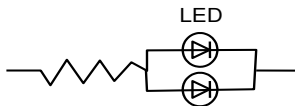

(A) Recommended circuit.

(B) The brightness of each LED might appear different due to the differences in the I-V characteristics of those LEDs.

7.2 Do not put any pressure on the light emitting surface either by finger or any hand tool and do not stack the COB products. Stress or pressure may cause damage to the wires of the LED array.

7.3 This product is not designed for the use under any of the following conditions, please confirm the performance and reliability are well enough if you use it under any of the following conditions

- Do not use sulfur-containing materials in commercial products including the materials such as seals and adhesives that may contain sulfur.
- Do not put this product in a place with a lot of moisture (over 85% relative humidity), dew condensation, briny air, and corrosive gas (Cl, H₂S, NH₃, SO₂, NO_x, etc.), exposure to a corrosive environment may affect silver plating.

ESD (Electrostatic Discharge)

Static Electricity or power surge will damage the LED. Suggestions to prevent ESD damage:

- Use of a conductive wrist band or anti-electrostatic glove when handling these LEDs.
- All devices, equipment, and machinery must be properly grounded.
- Work tables, storage racks, etc. should be properly grounded.
- Use ion blower to neutralize the static charge which might have built up on surface of the LED's plastic lens as a result of friction between LEDs during storage and handling.

ESD-damaged LEDs will exhibit abnormal characteristics such as high reverse leakage current, low forward voltage, or "no light up" at low currents.

To verify for ESD damage, check for "light up" and V_F of the suspect LEDs at low currents.