



Chipsmall Limited consists of a professional team with an average of over 10 year of expertise in the distribution of electronic components. Based in Hongkong, we have already established firm and mutual-benefit business relationships with customers from,Europe,America and south Asia,supplying obsolete and hard-to-find components to meet their specific needs.

With the principle of “Quality Parts,Customers Priority,Honest Operation,and Considerate Service”,our business mainly focus on the distribution of electronic components. Line cards we deal with include Microchip,ALPS,ROHM,Xilinx,Pulse,ON,Everlight and Freescale. Main products comprise IC,Modules,Potentiometer,IC Socket,Relay,Connector.Our parts cover such applications as commercial,industrial, and automotives areas.

We are looking forward to setting up business relationship with you and hope to provide you with the best service and solution. Let us make a better world for our industry!



Contact us

Tel: +86-755-8981 8866 Fax: +86-755-8427 6832

Email & Skype: info@chipsmall.com Web: www.chipsmall.com

Address: A1208, Overseas Decoration Building, #122 Zhenhua RD., Futian, Shenzhen, China





IR Emitter and Detector Product Data Sheet

LTR-3208

Spec No.: DS-50-92-0067

Effective Date: 04/09/2013

Revision: B

LITE-ON DCC

RELEASE

BNS-OD-FC001/A4



REV.A JAN 2013

FEATURES

- * WIDE RANGE OF COLLECTOR CURRENT
- * THE LENS IS FOR HIGH SENSITIVITY
- * LOW COST PLASTIC PACKAGE

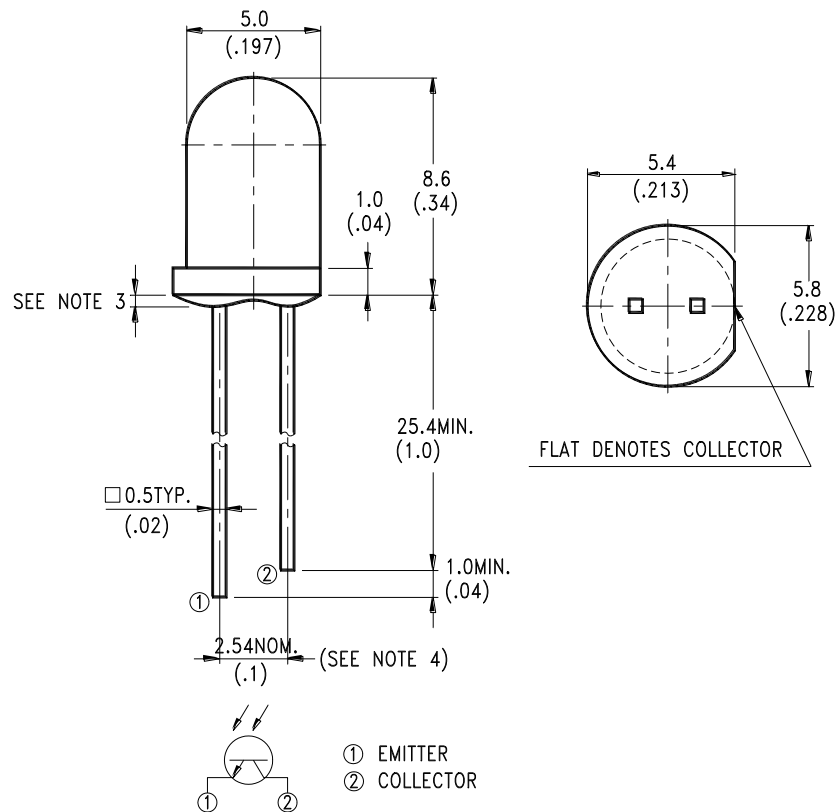
PACKAGE DIMENSIONS**NOTES:**

1. All dimensions are in millimeters (inches).
2. Tolerance is $\pm 0.25\text{mm}(.010\text{'})$ unless otherwise noted.
3. Protruded resin under flange is $1.5\text{mm}(.059\text{'})$ max.
4. Lead spacing is measured where the leads emerge from the package.
5. Specifications are subject to change without notice.



LITE-ON ELECTRONICS, INC.

Property of Lite-On Only

ABSOLUTE MAXIMUM RATINGS AT TA=25°C

PARAMETER	MAXIMUM RATING	UNIT
Power Dissipation	100	mW
Collector-Emitter Voltage	30	V
Emitter-Collector Voltage	5	V
Operating Temperature Range	-40°C to + 85°C	
Storage Temperature Range	-55°C to + 100°C	
Lead Soldering Temperature [1.6mm(.063") From Body]	260°C for 5 Seconds	

ELECTRICAL / OPTICAL CHARACTERISTICS AT TA=25°C

PARAMETER	SYMBOL	MIN.	TYP.	MAX.	UNIT	TEST CONDITION	BIN NO.
Collector-Emitter Breakdown Voltage	$V_{(BR)CEO}$	30			V	$I_C = 1mA$ $E_e = 0mW/cm^2$	
Emitter-Collector Breakdown Voltage	$V_{(BR)ECO}$	5			V	$I_E = 100\mu A$ $E_e = 0mW/cm^2$	
Collector Emitter Saturation Voltage	$V_{CE(SAT)}$		0.1	0.4	V	$I_C = 100\mu A$ $E_e = 1mW/cm^2$	
Rise Time	T_r		10		μs	$V_{CC} = 5V$ $I_C = 1mA$ $R_L = 1K\Omega$	
Fall Time	T_f		15		μs		
Collector Dark Current	I_{CEO}			100	nA	$V_{CE} = 10V$ $E_e = 0mW/cm^2$	
On State Collector Current	$I_{C(ON)}$	0.8		2.4	mA	$V_{CE} = 5V$ $E_e = 1mW/cm^2$ $\lambda = 940nm$	BIN C
		1.6		4.8			BIN D
		3.2		9.6			BIN E
		6.4					BIN F

TYPICAL ELECTRICAL / OPTICAL CHARACTERISTICS CURVES

(25°C Ambient Temperature Unless Otherwise Noted)

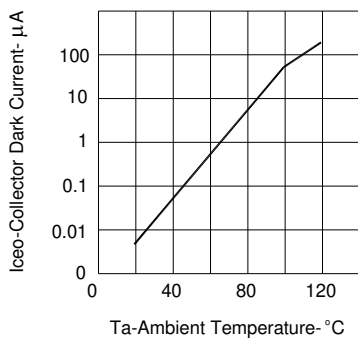

FIG.1 COLLECTOR DARK CURRENT VS AMBIENT TEMPERATURE

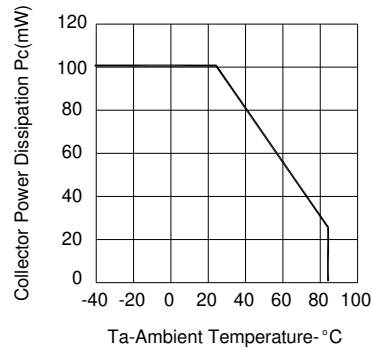

FIG.2 COLLECTOR POWER DISSIPATION VS AMBIENT TEMPERATURE

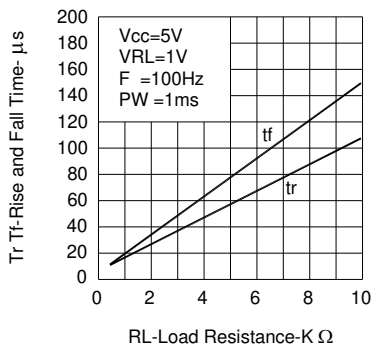

FIG.3 RISE AND FALL TIME VS LOAD RESISTANCE

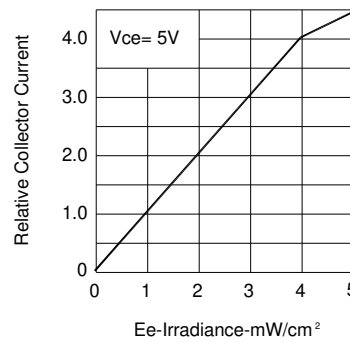

FIG.4 RELATIVE COLLECTOR CURRENT VS IRRADIANCE

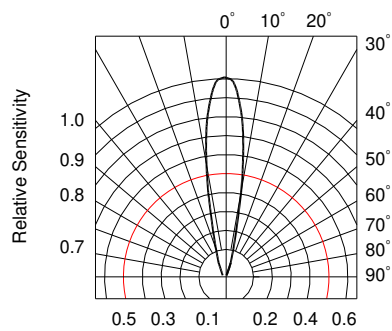

FIG.5 SENSITIVITY DIAGRAM

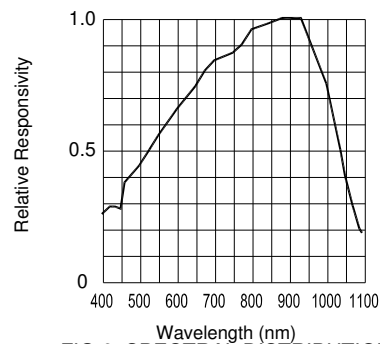

FIG.6 SPECTRAL DISTRIBUTION