



Chipsmall Limited consists of a professional team with an average of over 10 year of expertise in the distribution of electronic components. Based in Hongkong, we have already established firm and mutual-benefit business relationships with customers from,Europe,America and south Asia,supplying obsolete and hard-to-find components to meet their specific needs.

With the principle of “Quality Parts,Customers Priority,Honest Operation,and Considerate Service”,our business mainly focus on the distribution of electronic components. Line cards we deal with include Microchip,ALPS,ROHM,Xilinx,Pulse,ON,Everlight and Freescale. Main products comprise IC,Modules,Potentiometer,IC Socket,Relay,Connector.Our parts cover such applications as commercial,industrial, and automotives areas.

We are looking forward to setting up business relationship with you and hope to provide you with the best service and solution. Let us make a better world for our industry!



Contact us

Tel: +86-755-8981 8866 Fax: +86-755-8427 6832

Email & Skype: info@chipsmall.com Web: www.chipsmall.com

Address: A1208, Overseas Decoration Building, #122 Zhenhua RD., Futian, Shenzhen, China





SMD LAMP LED

OFFICE : 90 Chien I Road, Chung Ho
Taipei, Taiwan, R.O.C.

TEL : +886-2-2222-6181

FAX : +886-2-2226-5872

LTST-N683GBEW

DATASHEET

DATE : 2012/02/01

REV. NO. : -

PAGE : 0 of 15

Features

- * Meet ROHS, Green Product.
- * Package in 8mm tape on 7" diameter reels.
- * EIA STD package.
- * I.C. compatible
- * Compatible with automatic placement equipment.
- * Compatible with infrared reflow solder process.

Package Dimensions

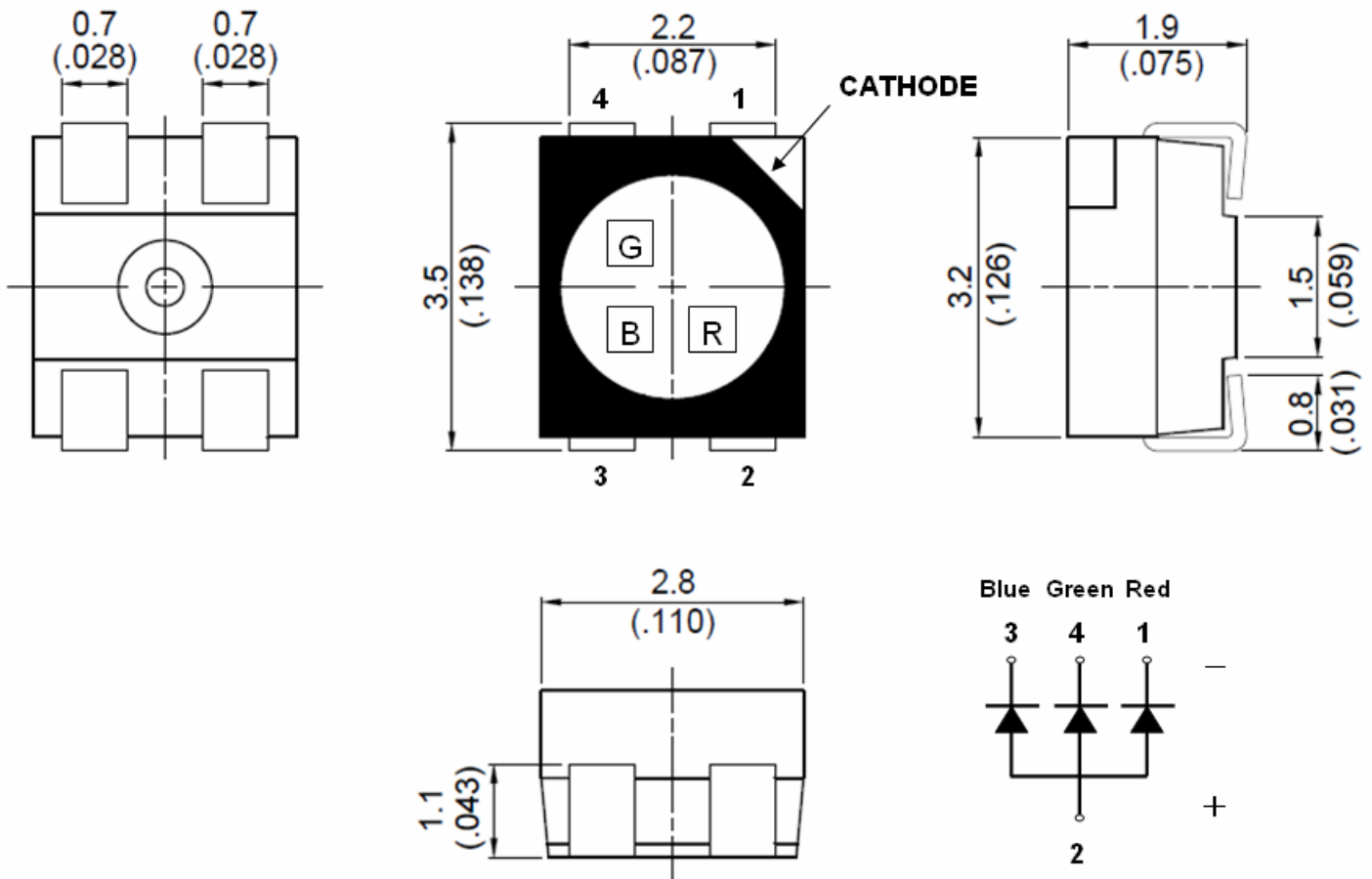

Part No.	Lens Color	Source Color	Pin Assignment
LTST-N683GBEW	Diffused Lens	AlInGaP Red	1
		InGaN Green	4
		InGaN Blue	3

Notes:

1. All dimensions are in millimeters (inches).
2. Tolerance is ± 0.2 mm (.008") unless otherwise noted.

Absolute Maximum Ratings at Ta=25°C

Parameter	LTST-N683GBEW			Unit
	Green	Blue	Red	
Power Dissipation	80	80	72	mW
Peak Forward Current (1/10 Duty Cycle, 0.1ms Pulse Width)	100	100	80	mA
DC Forward Current	20	20	30	mA
Operating Temperature Range	-40°C to +85°C			
Storage Temperature Range	-40°C to +100°C			

Suggest IR Reflow Condition For Pb Free Process:

IR-Reflow Soldering Profile for lead free soldering (Acc. to J-STD-020B)

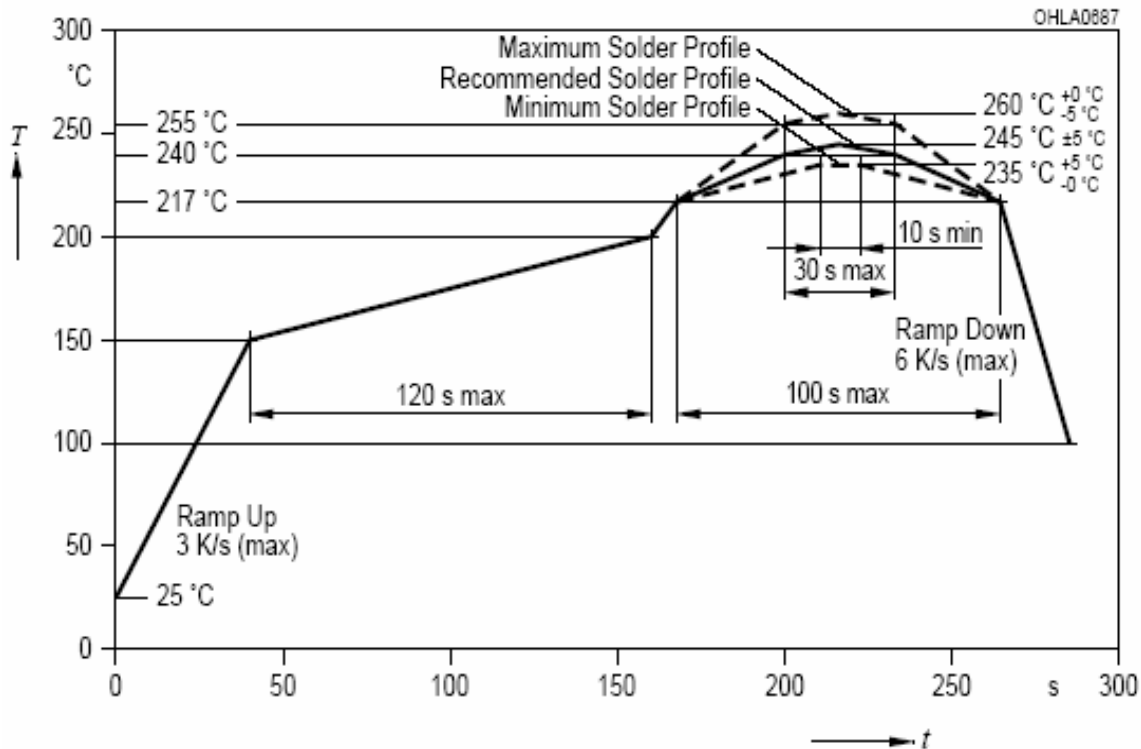

Electrical / Optical Characteristics at Ta=25°C

Parameter	Symbol		LTST-N683GBEW			Unit	Test Condition
			Green	Blue	Red		
Luminous Intensity	IV	MIN.	710	180	355	mcd	IF = 20mA Note 1
		TYP.	-	-	-		
		MAX.	1400	355	710		
Viewing Angle	$2\theta_{1/2}$	TYP.	120			deg	Note 2 (Fig.6)
Peak Emission Wavelength	λ_P	TYP.	518	468	632	nm	Measurement @Peak (Fig.1)
Dominant Wavelength	λ_d	MIN.	520	465	617	nm	IF = 20mA Note 3
		TYP.	525	470	624		
		MAX.	530	475	630		
Spectral Line Half-Width	$\Delta\lambda$	TYP.	35	25	20	nm	
Forward Voltage	VF	MIN.	2.8	2.8	1.8	V	IF = 20mA Note 4
		TYP.	-	-	-		
		MAX.	3.8	3.8	2.6		
Reverse Current	IR	MAX.	10	10	10	μA	VR = 5V Note 5

- NOTE: 1. Luminous intensity is measured with a light sensor and filter combination that approximates the CIE eye-response curve.
2. $\theta_{1/2}$ is the off-axis angle at which the luminous intensity is half the axial luminous intensity.
3. The dominant wavelength, λ_d is derived from the CIE chromaticity diagram and represents the single wavelength which defines the color of the device.
4. Forward Voltage Tolerance is +/- 0.1 volt.
5. Reverse voltage (VR) condition is applied to IR test only. The device is not designed for reverse operation.

Bin Code List

Luminous Intensity		Color : <u>Red</u> , Unit : mcd @20mA
Bin Code	Min.	Max.
T2	355.0	450.0
U1	450.0	560.0
U2	560.0	710.0

Tolerance on each Intensity bin is +/-11%

Luminous Intensity		Color : <u>Green</u> , Unit : mcd @20mA
Bin Code	Min.	Max.
V1	710.0	900.0
V2	900.0	1120.0
W1	1120.0	1400.0

Tolerance on each Intensity bin is +/-11%

Luminous Intensity		Color : <u>Blue</u> , Unit : mcd @20mA
Bin Code	Min.	Max.
S1	180.0	224.0
S2	224.0	280.0
T1	280.0	355.0

Tolerance on each Intensity bin is +/-11%

Bin Code List

Dominant Wavelength		Color : <u>Green</u> , Unit : nm @20mA	
Bin Code	Min.	Max.	
AP1	520.0	522.5	
AP2	522.5	525.0	
AQ1	525.0	527.5	
AQ2	527.5	530.0	

Tolerance for each Dominate Wavelength bin is +/- 1nm

Dominant Wavelength		Color : <u>Blue</u> , Unit : nm @20mA	
Bin Code	Min.	Max.	
AC1	465.0	467.5	
AC2	467.5	470.0	
AD1	470.0	472.5	
AD2	472.5	475.0	

Tolerance for each Dominate Wavelength bin is +/- 1nm

Bin Code on Tag Cross Table

		Luminous Intensity		Unit : mcd @20mA		
Bin Code On Tag	Red		Green		Blue	
	Code	Range	Code	Range	Code	Range
A1	T2	355-450	V1	710-900	S1	180-224
A2					S2	224-280
A3					T1	280-355
A4			V2	900-1120	S1	180-224
A5					S2	224-280
A6					T1	280-355
A7			W1	1120-1400	S1	180-224
A8					S2	224-280
A9					T1	280-355
B1	U1	450-560	V1	710-900	S1	180-224
B2					S2	224-280
B3					T1	280-355
B4			V2	900-1120	S1	180-224
B5					S2	224-280
B6					T1	280-355
B7			W1	1120-1400	S1	180-224
B8					S2	224-280
B9					T1	280-355

Tolerance on each Intensity bin is +/-11%

Bin Code on Tag Cross Table

Luminous Intensity							Unit : mcd @20mA	
Bin Code on Tag	Red		Green		Blue			
	Code	Range	Code	Range	Code	Range		
C1	U2	560-710	V1	710-900	S1	180-224		
C2					S2	224-280		
C3					T1	280-355		
C4			V2	900-1120	S1	180-224		
C5					S2	224-280		
C6					T1	280-355		
C7			W1	1120-1400	S1	180-224		
C8					S2	224-280		
C9					T1	280-355		

Tolerance on each Intensity bin is +/-11%

Bin Code on Tag Cross Table

		Dominant Wavelength		Unit : nm @20mA		
Bin Code on Tag	Red		Green		Blue	
	Code	Range	Code	Range	Code	Range
D1	-	617-630	AP1	520.0-522.5	AC1	465.0-467.5
D2					AC2	467.5-470.0
D3					AD1	470.0-472.5
D4					AD2	472.5-475.0
D5			AP2	522.5-525.0	AC1	465.0-467.5
D6					AC2	467.5-470.0
D7					AD1	470.0-472.5
D8					AD2	472.5-475.0
D9			AQ1	525.0-527.5	AC1	465.0-467.5
D10					AC2	467.5-470.0
D11					AD1	470.0-472.5
D12					AD2	472.5-475.0
D13			AQ2	527.5-530.0	AC1	465.0-467.5
D14					AC2	467.5-470.0
D15					AD1	470.0-472.5
D16					AD2	472.5-475.0

Tolerance for each Dominate Wavelength Bin is +/- 1nm

Property of Lite-On Only

Typical Electrical / Optical Characteristics Curves (25°C Ambient Temperature Unless Otherwise Noted)

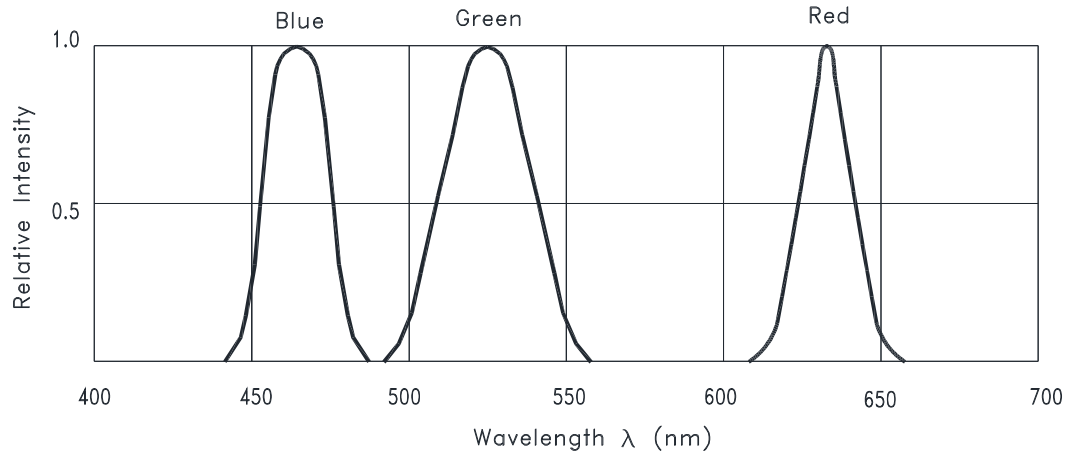

Fig.1 RELATIVE INTENSITY VS. WAVELENGTH

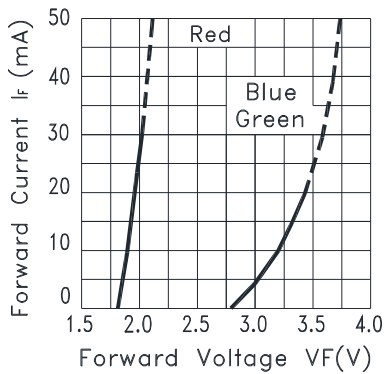

Fig.2 FORWARD CURRENT VS. FORWARD VOLTAGE

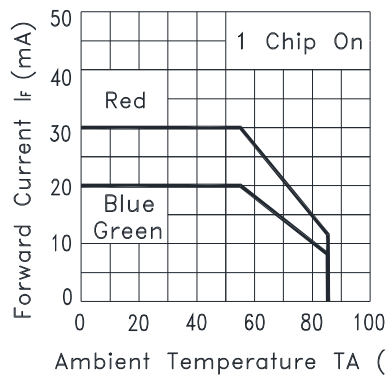

Fig.3 FORWARD CURRENT DERATING CURVE

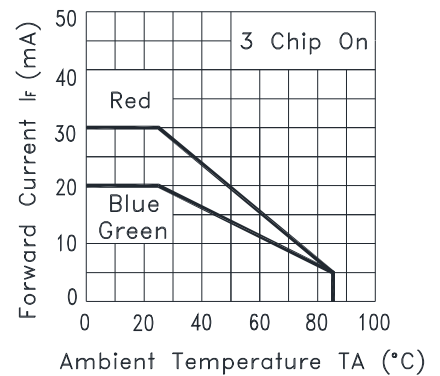

Fig.4 FORWARD CURRENT DERATING CURVE

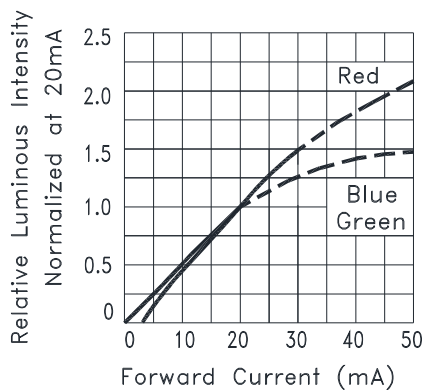

Fig.5 RELATIVE LUMINOUS INTENSITY VS. FORWARD CURRENT

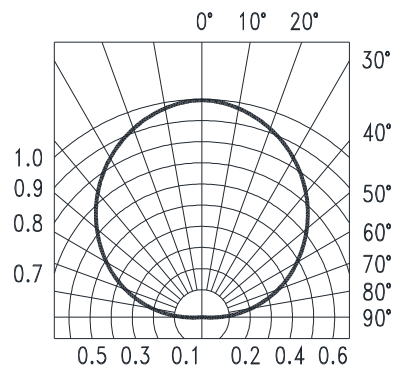
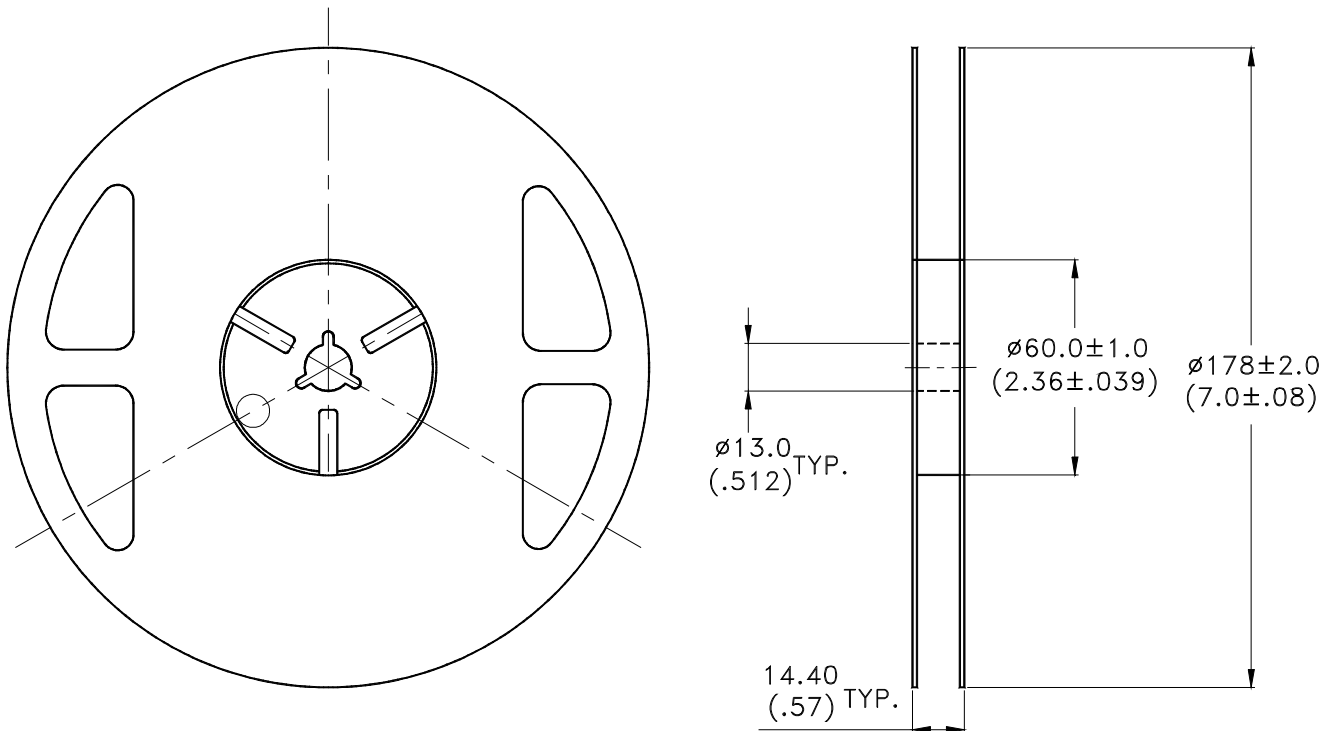

Fig.6 SPATIAL DISTRIBUTION

Package Dimensions of Reel

Notes:

1. Empty component pockets sealed with top cover tape.
2. 7 inch reel-2000 pieces per reel.
3. Minimum packing quantity is 500 pieces for remainders.
4. The maximum number of consecutive missing lamps is two.
5. In accordance with ANSI/EIA 481 specifications.

CAUTIONS

1. Application

The LEDs described here are intended to be used for ordinary electronic equipment (such as office equipment, communication equipment and household applications). Consult Liteon's Sales in advance for information on applications in which exceptional reliability is required, particularly when the failure or malfunction of the LEDs may directly jeopardize life or health (such as in aviation, transportation, traffic control equipment, medical and life support systems and safety devices).

2. Storage

The package is sealed:

The LEDs should be stored at 30°C or less and 70%RH or less. And the LEDs are limited to use within one year, while the LEDs is packed in moisture-proof package with the desiccants inside.

The package is opened:

The storage ambient for the LEDs should not exceed 30°C temperature and 60% relative humidity.

It is recommended that LEDs out of their original packaging are IR-reflowed within 168hrs.

For extended storage out of their original packaging, it is recommended that the LEDs be stored in a sealed container with appropriate desiccant, or in a desiccators with nitrogen ambient.

LEDs stored out of their original packaging for more than 168hrs should be baked at about 60 deg C for at least 48 hours before solder assembly.

3. Cleaning

Use alcohol-based cleaning solvents such as isopropyl alcohol to clean the LED if necessary.

4. Soldering

Recommended soldering conditions:

Reflow soldering		Soldering iron	
Pre-heat	150~200°C	Temperature	300°C Max.
Pre-heat time	120 sec. Max.	Soldering time	3 sec. Max.
Peak temperature	260°C Max.		(one time only)
Soldering time	10 sec. Max.(Max. two times)		

Soldering notes:

Because different board designs use different number and types of devices, solder pastes, reflow ovens, and circuit boards, no single temperature profile works for all possible combinations.

However, you can successfully mount your packages to the PCB by following the proper guidelines and PCB-specific characterization.

LITE-ON Runs both component-level verification using in-house **KYRAMX98** reflow chambers and board-level assembly.

The results of this testing are verified through post-reflow reliability testing.

Profiles used at LITE-ON are based on JEDEC standards to ensure that all packages can be successfully and reliably surface mounted.

Figure on page3 shows a sample temperature profile compliant to JEDEC standards.

You can use this example as a generic target to set up your reflow process.

You should adhere to the JEDEC profile limits as well as specifications and recommendations from the solder paste manufacturer to avoid damaging the device and create a reliable solder joint.

5. Drive Method

An LED is a current-operated device. In order to ensure intensity uniformity on multiple LEDs connected in parallel in an application, it is recommended that a current limiting resistor be incorporated in the drive circuit, in series with each LED as shown in Circuit A below.

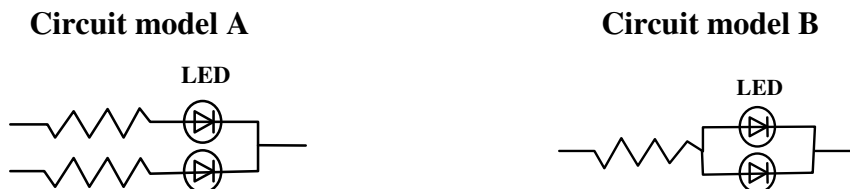

(A) Recommended circuit.

(B) The brightness of each LED might appear different due to the differences in the I-V characteristics of those LEDs.

6. ESD (Electrostatic Discharge)

Static Electricity or power surge will damage the LED.

Suggestions to prevent ESD damage:

- Use of a conductive wrist band or anti-electrostatic glove when handling these LEDs.
- All devices, equipment, and machinery must be properly grounded.
- Work tables, storage racks, etc. should be properly grounded.
- Use ion blower to neutralize the static charge which might have built up on surface of the LED's plastic lens as a result of friction between LEDs during storage and handling.

ESD-damaged LEDs will exhibit abnormal characteristics such as high reverse leakage current, low forward voltage, or “no lightup” at low currents.

To verify for ESD damage, check for “lightup” and V_f of the suspect LEDs at low currents.

The V_f of “good” LEDs should be $>2.0V@0.1mA$ for InGaN product and $>1.4V@0.1mA$ for AlInGaP product.

7. Reliability Test

No.	Test item	Test condition	Reference standard
1	Resistance to soldering heat	Tsld = 260°C, 10sec. 3 times	JEITA ED-4701 300 301
2	Solderability	Tsld=245± 5°C (Lead Free Solder, Coverage ≥ 95% of the dipped surface)	JEITA ED-4701 300 303
3	Thermal Shock	85 ± 5°C ~ -30°C ± 5°C 30min 30min 100cycles	JEITA ED-4701 300 307
4	Temperature Cycle	-55°C ~ 25°C ~ 100°C ~ 25°C 30min 5min 30min 5min 100cycles	JEITA ED-4701 100 105
5	High Temperature Storage	100°C 1000hrs	JEITA ED-4701 200 201
6	Low Temperature Storage	-55°C 1000hrs	JEITA ED-4701 200 202
7	Temperature Humidity Storage	60°C/90%RH 300hrs	JEITA ED-4701 100 103
8	Room temp life test	25°C, IF: Max current , 1000hrs	--

8. Others

The appearance and specifications of the product may be modified for improvement without prior notice.

9. Suggested Checking List

Training and Certification

1. Everyone working in a static-safe area is ESD-certified?
2. Training records kept and re-certification dates monitored?

Static-Safe Workstation & Work Areas

1. Static-safe workstation or work-areas have ESD signs?
2. All surfaces and objects at all static-safe workstation and within 1 ft measure less than 100V?
3. All ionizer activated, positioned towards the units?
4. Each work surface mats grounding is good?

Personnel Grounding

1. Every person (including visitors) handling ESD sensitive (ESDS) items wears wrist strap, heel strap or conductive shoes with conductive flooring?
2. If conductive footwear used, conductive flooring also present where operator stand or walk?
3. Garments, hairs or anything closer than 1 ft to ESD items measure less than 100V*?
4. Every wrist strap or heel strap/conductive shoes checked daily and result recorded for all DLs?
5. All wrist strap or heel strap checkers calibration up to date?

Note: *50V for Blue LED.

Device Handling

1. Every ESDS items identified by EIA-471 labels on item or packaging?
2. All ESDS items completely inside properly closed static-shielding containers when not at static-safe workstation?
3. No static charge generators (e.g. plastics) inside shielding containers with ESDS items?
4. All flexible conductive and dissipative package materials inspected before reuse or recycles?

Others

1. Audit result reported to entity ESD control coordinator?
2. Corrective action from previous audits completed?
3. Are audit records complete and on file?