



Chipsmall Limited consists of a professional team with an average of over 10 year of expertise in the distribution of electronic components. Based in Hongkong, we have already established firm and mutual-benefit business relationships with customers from,Europe,America and south Asia,supplying obsolete and hard-to-find components to meet their specific needs.

With the principle of "Quality Parts,Customers Priority,Honest Operation,and Considerate Service",our business mainly focus on the distribution of electronic components. Line cards we deal with include Microchip,ALPS,ROHM,Xilinx,Pulse,ON,Everlight and Freescale. Main products comprise IC,Modules,Potentiometer,IC Socket,Relay,Connector.Our parts cover such applications as commercial,industrial, and automotives areas.

We are looking forward to setting up business relationship with you and hope to provide you with the best service and solution. Let us make a better world for our industry!



## Contact us

Tel: +86-755-8981 8866 Fax: +86-755-8427 6832

Email & Skype: info@chipsmall.com Web: www.chipsmall.com

Address: A1208, Overseas Decoration Building, #122 Zhenhua RD., Futian, Shenzhen, China





Photocoupler  
Product Data Sheet  
LTV-2X7 Series  
(Half Pitch LO Own Brand  
Series)

Spec No. :DS70-2009-0014

Effective Date: 05/19/2017

Revision: 0

**LITE-ON DCC**

**RELEASE**

BNS-OD-FC001/A4

## Photocoupler LTV-2X7 series

### 1. DESCRIPTION

#### 1.1 Features

- Current transfer ratio (CTR) : MIN. 50% at  $I_F = 5\text{mA}$ ,  $V_{CE} = 5\text{V}$
- High input-output isolation voltage. ( $V_{iso}=3,750\text{Vrms}$ )
- Employs double transfer mold technology
- Safety approval:
  - UL 1577
  - VDE DIN EN60747-5-5 (VDE 0884-5) ,
  - CSA CA5A
  - FIMKO
- RoHS Compliance: All materials be used in device are followed EU RoHS directive (No.2002/95/EC).
- ESD pass HBM 8000V/MM2000V
- MSL class1
- Halogen Free

#### 1.2 Applications

- Hybrid substrates that require high density mounting.
- Programmable controllers
- System appliances, measuring instruments

## Photocoupler LTV-2X7 series

### 2. PACKAGE DIMENSIONS

#### 2.1 LTV-217

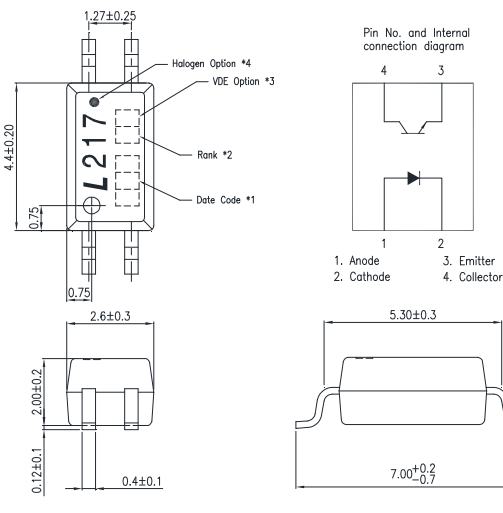

#### 2.2 LTV-227

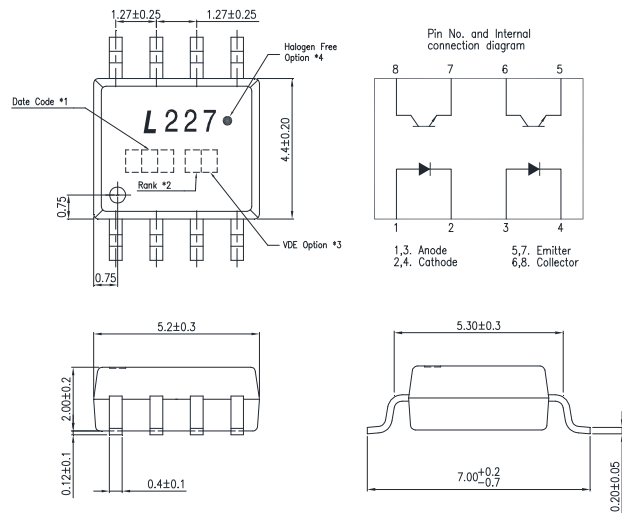

#### 2.3 LTV-247

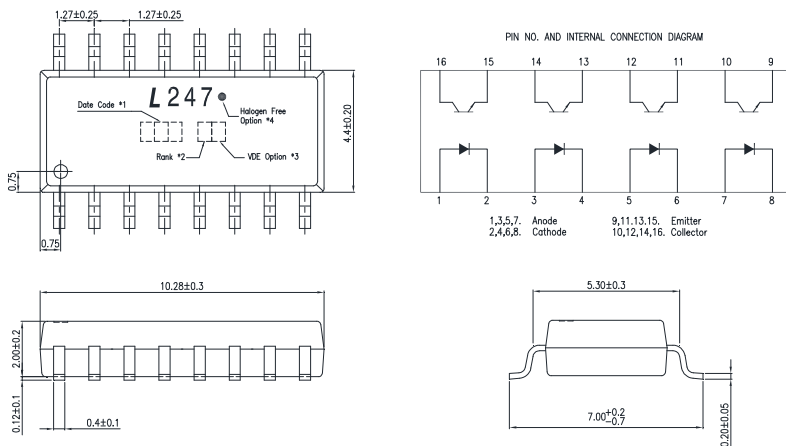

#### Notes :

- 3-digit date code.
- Rank shall be or shall not be marked
- VDE mark only appears on devices or ordered "V" option.
- "●" indicates Halogen free option.

\*All dimensions in millimeters.

## Photocoupler LTV-2X7 series

### 3. TAPING DIMENSIONS

#### 3.1 LTV-217

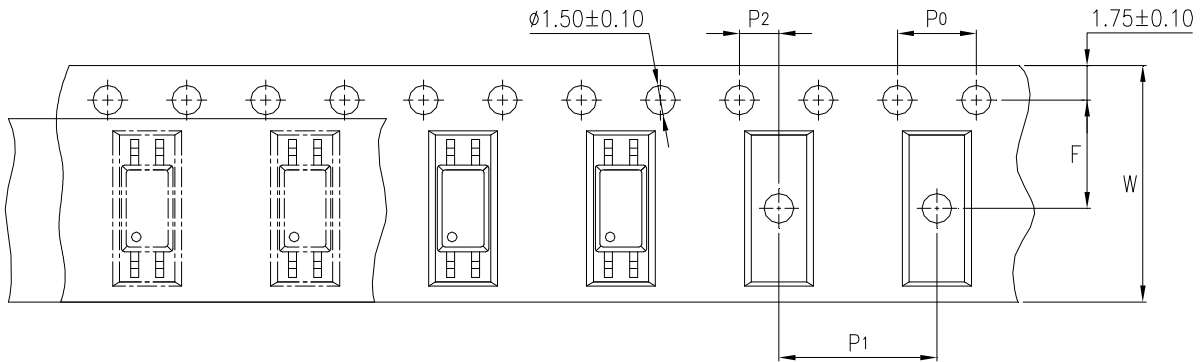

#### 3.2 LTV-217-TP1

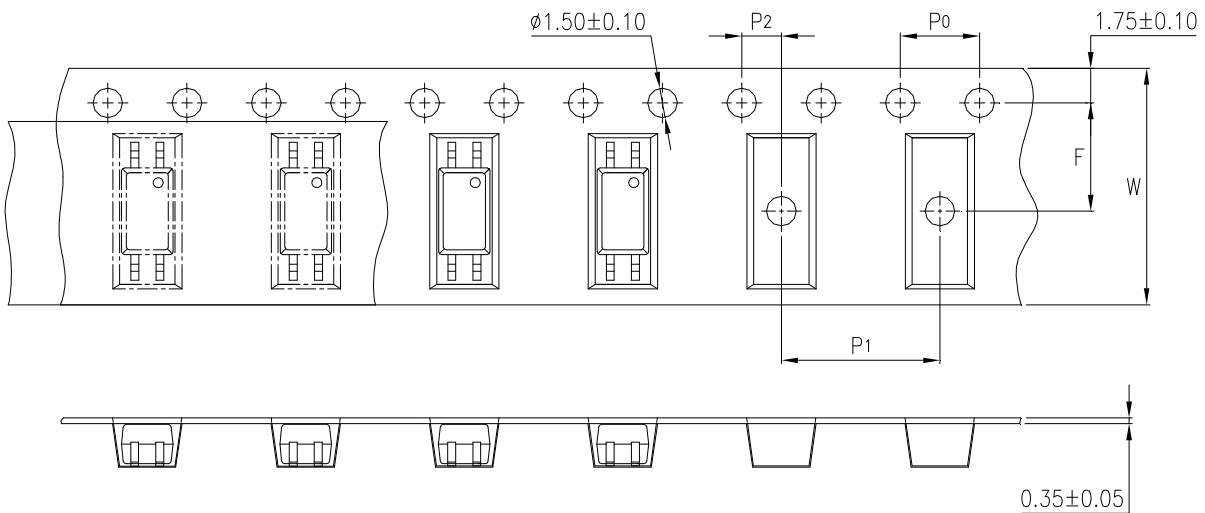

Description	Symbol	Dimension in mm (inch)
Tape wide	W	12±0.3 (0.47)
Pitch of sprocket holes	P <sub>0</sub>	4±0.1 (0.15)
Distance of compartment	F	5.5±0.1 (0.217)
	P <sub>2</sub>	2±0.1 (0.079)
Distance of compartment to compartment	P <sub>1</sub>	8±0.1 (0.315)

**Photocoupler  
LTV-2X7 series**

**3.3 LTV-227**

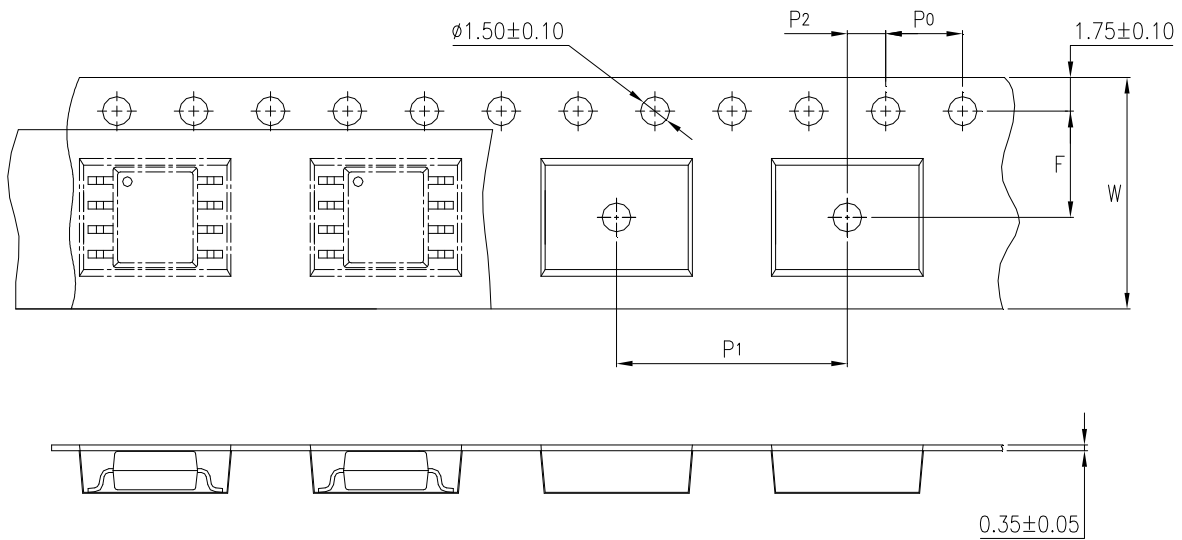

Description	Symbol	Dimension in mm (inch)
Tape wide	W	12±0.3 (0.47)
Pitch of sprocket holes	P <sub>0</sub>	4±0.1 (0.15)
Distance of compartment	F	5.5±0.1 (0.217)
	P <sub>2</sub>	2±0.1 (0.079)
Distance of compartment to compartment	P <sub>1</sub>	8±0.1 (0.315)

## Photocoupler LTV-2X7 series

### 3.4 LTV-247

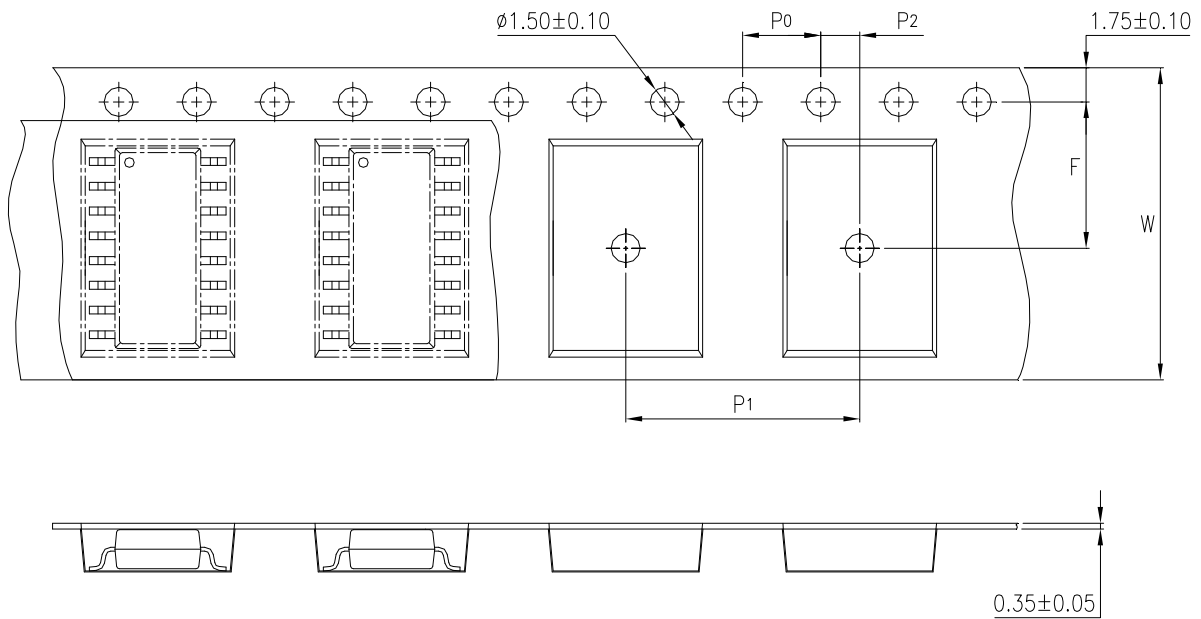

Description	Symbol	Dimension in mm (inch)
Tape wide	W	16±0.3 (0.47)
Pitch of sprocket holes	P <sub>0</sub>	4±0.1 (0.15)
Distance of compartment	F	7.5±0.1 (0.217)
	P <sub>2</sub>	2±0.1 (0.079)
Distance of compartment to compartment	P <sub>1</sub>	12±0.1 (0.315)

### 3.5 Quantities per Reel

Package Type	LTV-217	LTV-227	LTV-247
Quantities (pcs)	3000	2000	2000

## Photocoupler LTV-2X7 series

### 4. RATING AND CHARACTERISTICS

#### 4.1 Absolute Maximum Ratings at Ta=25°C

	Parameter	Symbol	Rating			Unit
			217	227	247	
Input	Forward Current	$I_F$	50			mA
	Reverse Voltage	$V_R$	6			V
	Power Dissipation	P	70			mW
	Pulse Forward Current	$I_{FSM}$	1			A
	Junction Temperature	$T_J$	125			°C
Output	Collector - Emitter Voltage	$V_{CEO}$	80			V
	Emitter - Collector Voltage	$V_{ECO}$	7			V
	Collector Current	$I_C$	50			mA
	Collector Power Dissipation	$P_C$	150		100	mW
	Junction Temperature	$T_J$	125			°C
	Total Power Dissipation	$P_{tot}$	200		170	mW
1.	Isolation Voltage	$V_{iso}$	3750			$V_{rms}$
	Operating Temperature	$T_{opr}$	-55 ~ +110			°C
	Storage Temperature	$T_{stg}$	-55 ~ +150			°C
2.	Soldering Temperature	$T_{sol}$	260			°C

1. AC For 1 Minute, R.H. = 40 ~ 60%

Isolation voltage shall be measured using the following method.

- (1) Short between anode and cathode on the primary side and between collector and emitter on the secondary side.
- (2) The isolation voltage tester with zero-cross circuit shall be used.
- (3) The waveform of applied voltage shall be a sine wave.

2. For 10 Seconds



## Photocoupler LTV-2X7 series

### 4.2 ELECTRICAL OPTICAL CHARACTERISTICS at Ta=25°C

Parameter		Symb	Min.	Typ.	Max.	Unit	Test Condition
Input	Forward Voltage	$V_F$	—	1.2	1.4	V	$I_F=20\text{mA}$
	Reverse Current	$I_R$	—	—	10	$\mu\text{A}$	$V_R=4\text{V}$
	Terminal Capacitance	$C_t$	—	30	250	pF	$V=0, f=1\text{KHz}$
Output	Collector Dark Current	$I_{CEO}$	—	—	100	nA	$V_{CE}=20\text{V}, I_F=0$
	Collector-Emitter Breakdown Voltage	$BV_{CEO}$	80	—	—	V	$I_C=0.1\text{mA}, I_F=0$
	Emitter-Collector Breakdown Voltage	$BV_{ECO}$	7	—	—	V	$I_E=10\mu\text{A}, I_F=0$
TRANSFER CHARACTERISTICS	Collector Current	$I_C$	2.5	—	30	mA	$I_F=5\text{mA}$
	1. Current Transfer Ratio	CTR	50	—	600	%	$V_{CE}=5\text{V}$
	Collector-Emitter Saturation Voltage	$V_{CE(sat)}$	—	—	0.4	V	$I_F=8\text{mA}$ $I_C=2.4\text{mA}$
	Isolation Resistance	$R_{iso}$	$5 \times 10^{10}$	$1 \times 10^{11}$	—	$\Omega$	DC500V, 40 ~ 60% R.H.
	Floating Capacitance	$C_f$	—	0.6	1	pF	$V=0, f=1\text{MHz}$
	Response Time (Rise)	$t_r$	—	2	18	$\mu\text{s}$	$V_{CE}=10\text{V},$
	Response Time (Fall)	$t_f$	—	3	18	$\mu\text{s}$	$I_C=2\text{mA}$
	Turn-On Time	$T_{ON}$	—	3	—	$\mu\text{s}$	$R_L=100\Omega,$
	Turn-Off Time	$T_{OFF}$	—	3	—	$\mu\text{s}$	$f=100\text{Hz}$
	Turn-On Time	$t_{ON}$	—	2	—	$\mu\text{s}$	$V_{CE}=5\text{V}, I_C=16\text{mA}$ $R_L=1.9\text{K}\Omega$
	Storage Time	$T_s$	—	25	—	$\mu\text{s}$	
	Turn-Off Time	$t_{OFF}$	—	40	—	$\mu\text{s}$	

$$1. \text{ CTR} = \frac{I_C}{I_F} \times 100\%$$

**Photocoupler  
LTV-2X7 series**

**5. RANK TABLE OF CURRENT TRANSFER RATIO CTR**

MODEL NO.	CTR Rank	Min	Max	Condition
LTV-217	A	80	160	$I_F=5mA, V_{CE}=5V, T_a=25^{\circ}C$
	A1	100	160	
	B	130	260	
	C	200	400	
	D	300	600	
	A or B or C or D or No mark	50	600	
LTV-227	B	130	260	
	C	200	400	
	B or C or No mark	50	600	
LTV-247	No mark	100	600	

## Photocoupler LTV-2X7 series

### 6. CHARACTERISTICS CURVES (TYPICAL PERFORMANCE)

Figure 1. Collector Power Dissipation vs. Ambient Temperature

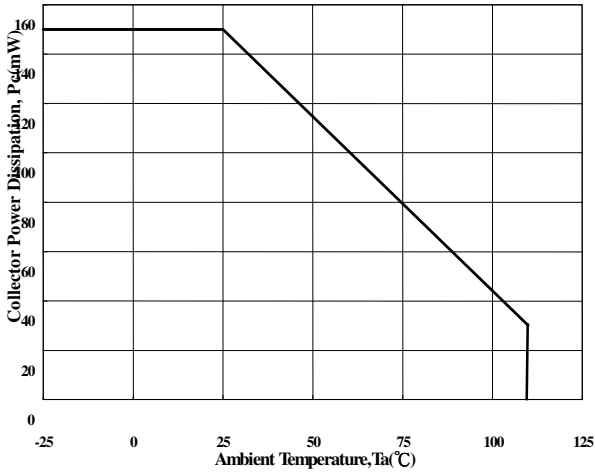

Figure 2. Forward Current vs. Ambient Temperature

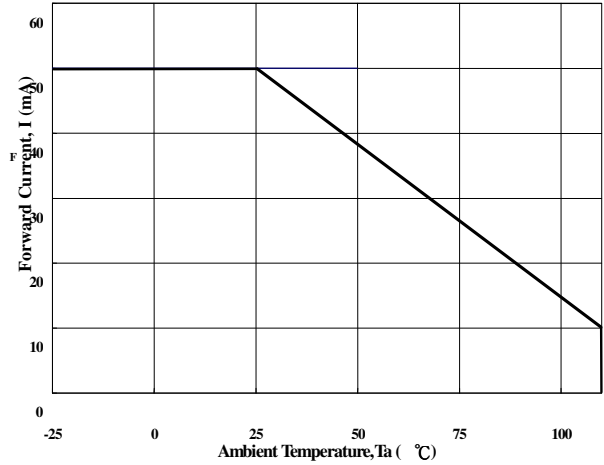

Figure 3. Forward Current vs. Forward Voltage

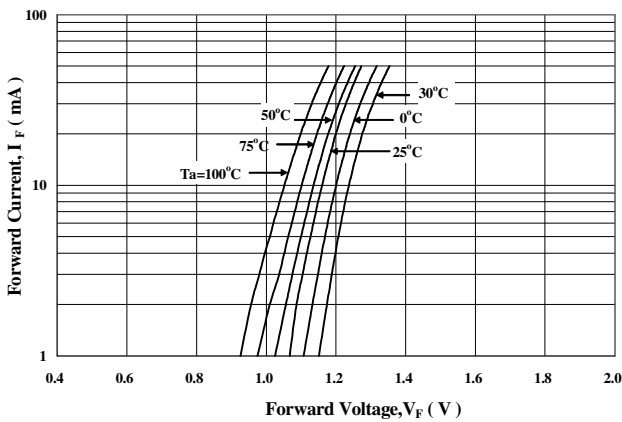

Figure 4. Forward Voltage Temperature Coefficient vs. Forward Current

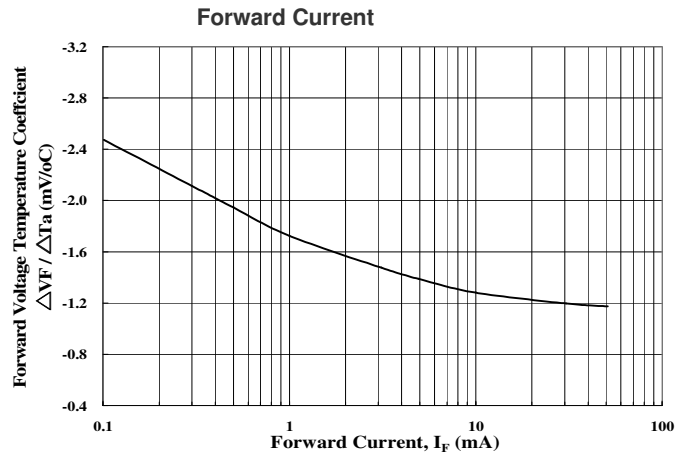

Figure 5. Pulse Forward Current vs. Duty Cycle Ratio

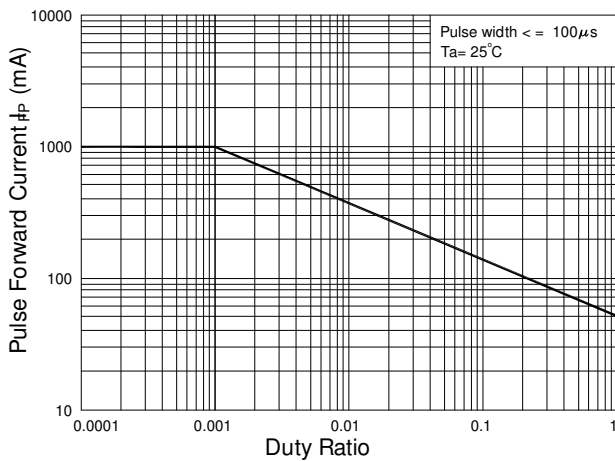
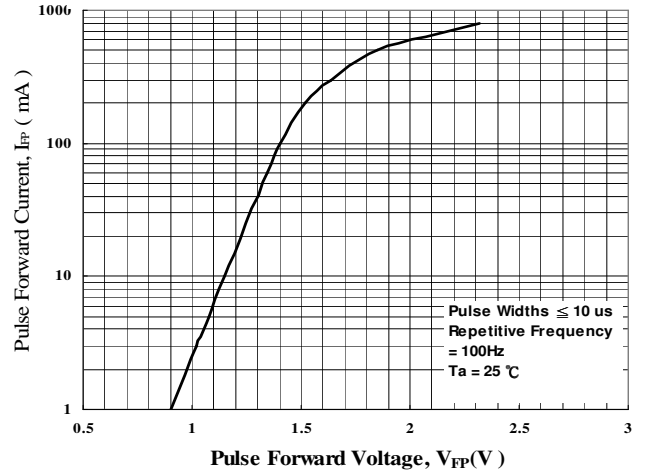

Figure 6. Pulse Forward Current vs. Pulse Forward Voltage



## Photocoupler LTV-2X7 series

Figure 7. Collector-Emitter Saturation Voltage vs. Forward Current

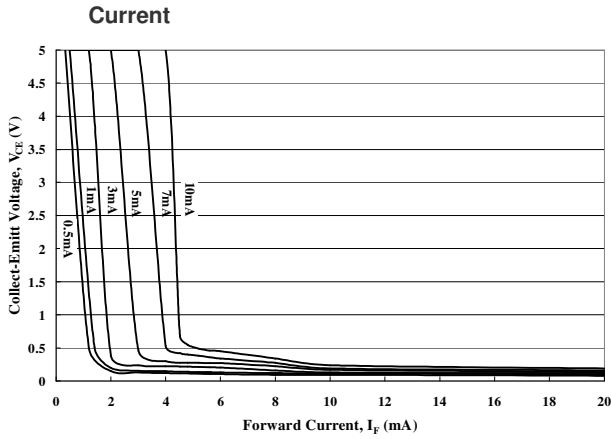

Figure 8. Collector Current vs. Collector-Emitter

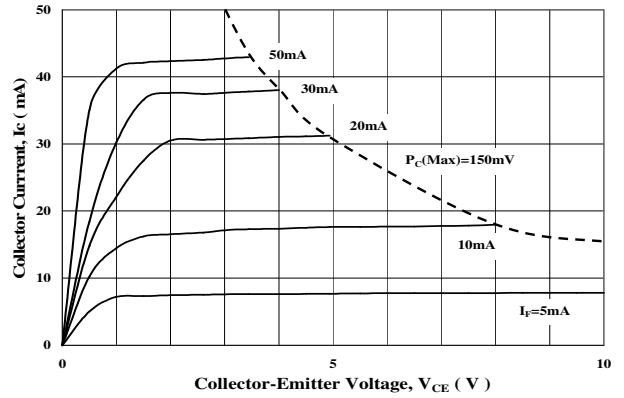

Figure 9. Collector Current vs. Small Collector-Emitter

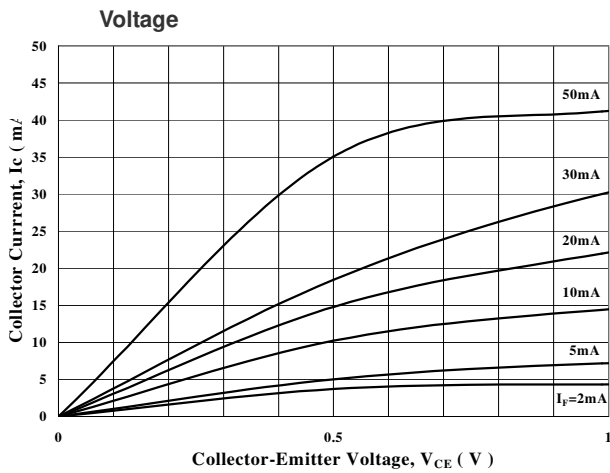

Figure 10. Normalized CTR vs. Forward Current

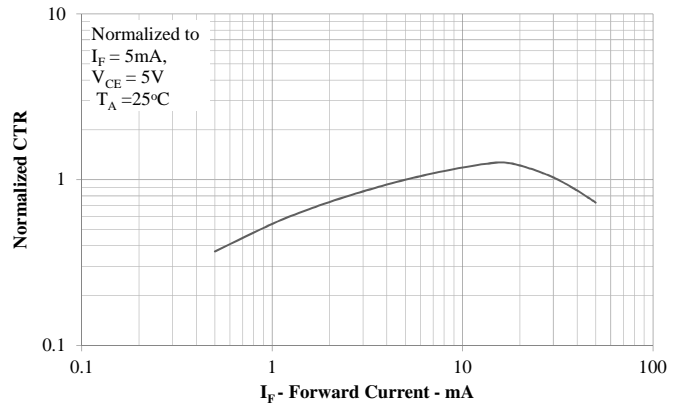

Figure 11. Collector Dark Current vs. Ambient Temperature

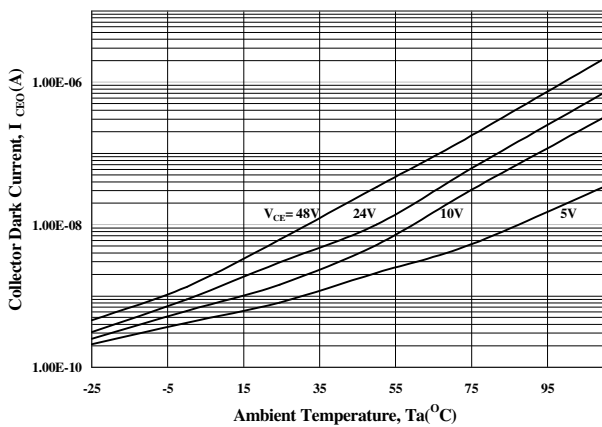
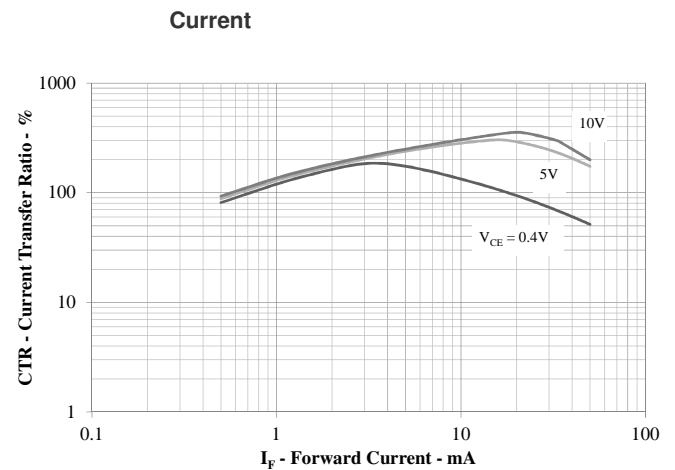

Figure 12. Current Transfer Ratio vs. Forward Current



## Photocoupler LTV-2X7 series

Figure 13. Normalized CTR vs. Ambient Temperature

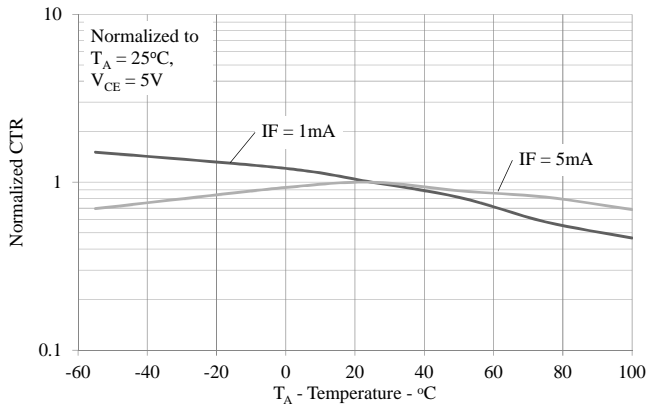

Figure 15. Collector Current vs. Ambient Temperature

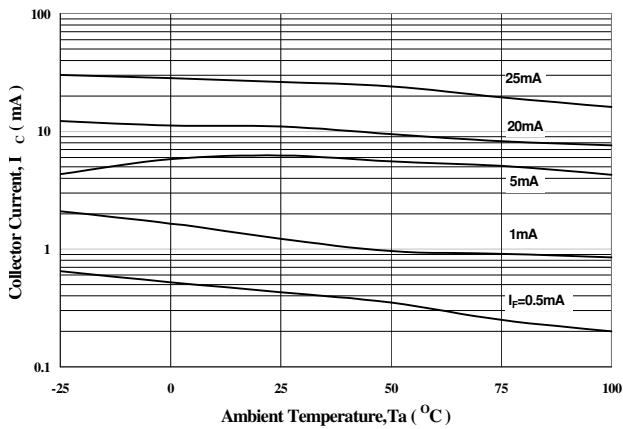

Figure 17. Switching Time vs. Ambient Temperature

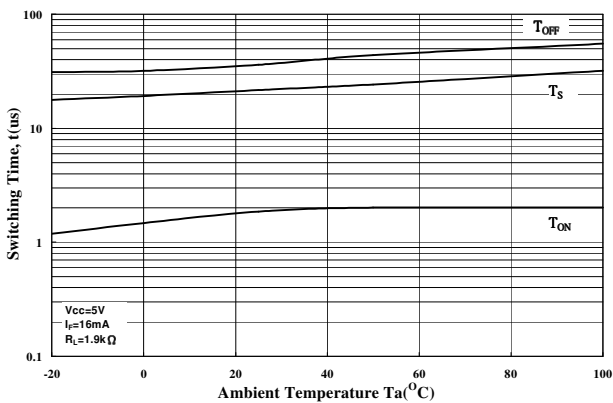

Figure 14. Collector-Emitter Saturation Voltage vs. Ambient Temperature

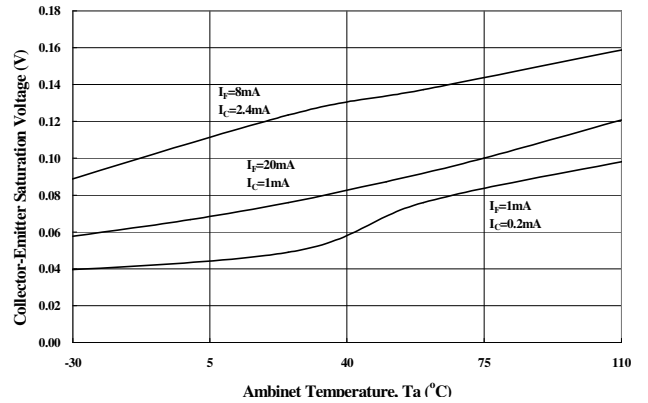

Figure 16. Switching Time vs. Load Resistance

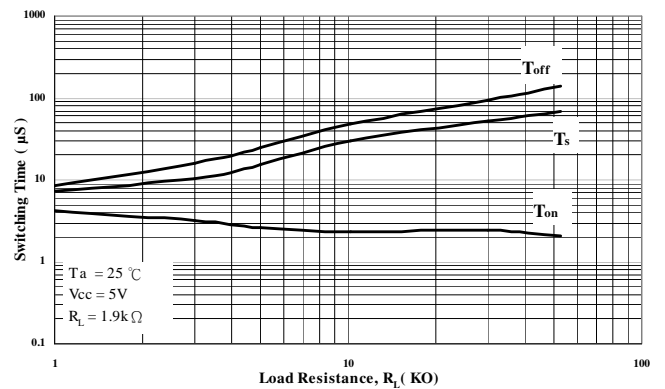
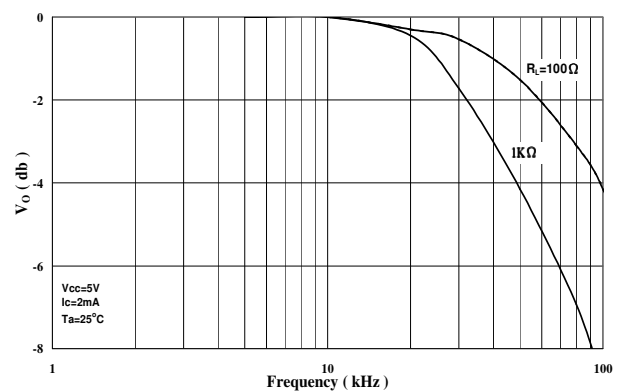
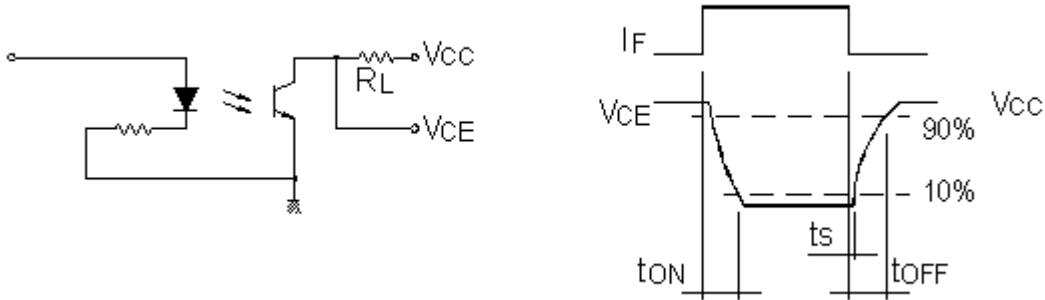

Figure 18. Frequency Response



## Photocoupler LTV-2X7 series

### 7. SWITCHING TIME TEST CIRCUIT



### 8. TEMPERATURE PROFILE OF SOLDERING

#### 8.1 IR Reflow soldering (JEDEC-STD-020C compliant)

One time soldering reflow is recommended within the condition of temperature and time profile shown below. Do not solder more than three times.

Profile item	Conditions
Preheat	
- Temperature Min ( $T_{Smin}$ )	150°C
- Temperature Max ( $T_{Smax}$ )	200°C
- Time (min to max) (ts)	90±30 sec
Soldering zone	
- Temperature ( $T_L$ )	217°C
- Time ( $t_L$ )	60 ~100 sec
Peak Temperature ( $T_P$ )	260°C
Ramp-up rate	3°C / sec max.
Ramp-down rate	3~6°C / sec

Photocoupler  
LTV-2X7 series

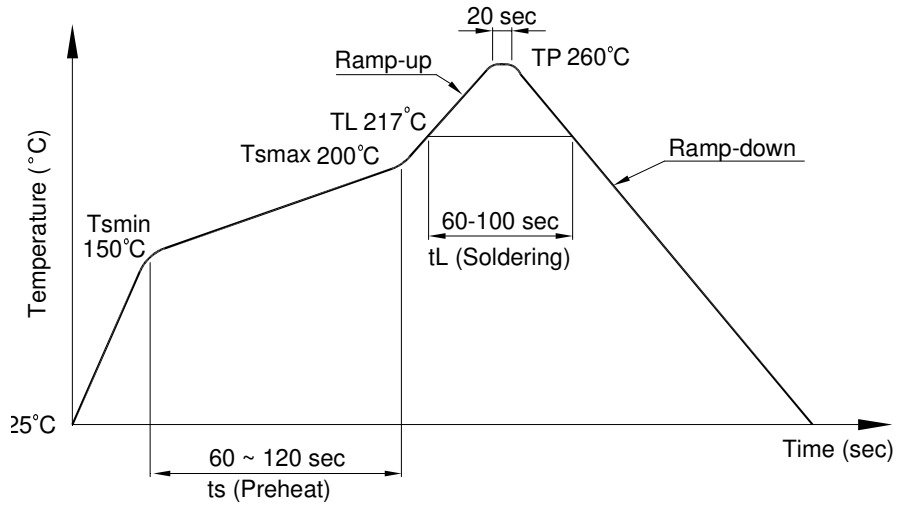

8.2 Wave soldering (JEDEC22A111 compliant)

One time soldering is recommended within the condition of temperature.

Temperature: 260+0/-5°C

Time: 10 sec.

Preheat temperature: 25 to 140°C

Preheat time: 30 to 80 sec.

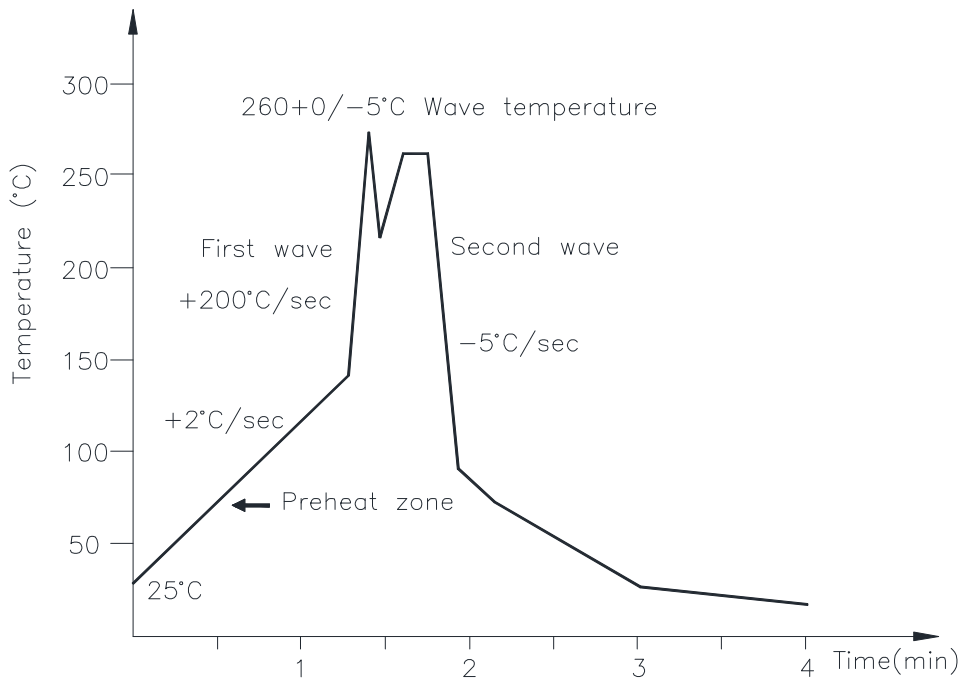

## Photocoupler LTV-2X7 series

### 8.3 Hand soldering by soldering iron

Allow single lead soldering in every single process. One time soldering is recommended.

Temperature: 380+0/-5°C

Time: 3 sec max.

## 9. RECOMMENDED FOOT PRINT PATTERNS (MOUNT PAD)

Unit: mm

### 9.1 LTV-217

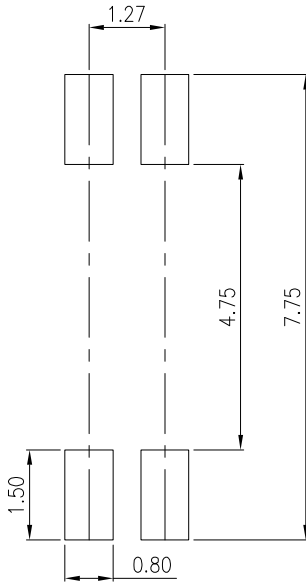

### 9.2 LTV-227

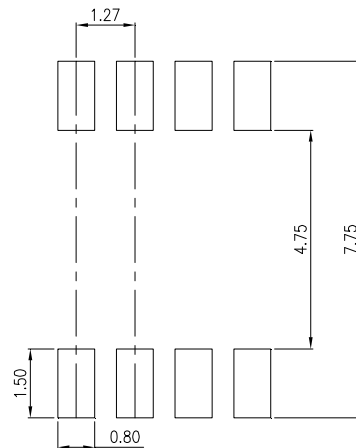

### 9.3 LTV-247

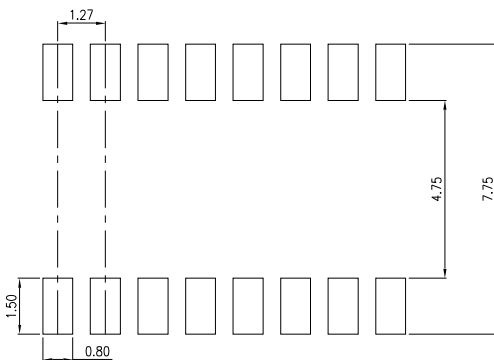



**Photocoupler  
LTV-2X7 series**

**10. NAMING RULE**

**LTV-2X7-(1)-(2)-G**

DEVICE PART NUMBER

(1) TAPING TYPE (TP1 or no suffix)

Please refer to orientation of taping on Page P3-P5

(2) CTR RANK

Please refer to the CTR table on Page P8

(3) Halogen free option

Example : LTV-217-TP-A-G

**LTV2X7(1)(2)-V-G**

DEVICE PART NUMBER

(1) TAPING TYPE (TP1 or no suffix)

Please refer to orientation of taping on Page P3-P5

(2) CTR RANK

Please refer to the CTR table on Page P8

(3) VDE order option

(4) Halogen free option

Example : LTV217TPA-V-G

**11. NOTES**

- LiteOn is continually improving the quality, reliability, function or design and LiteOn reserves the right to make changes without further notices.
- The products shown in this publication are designed for the general use in electronic applications such as office automation equipment, communications devices, audio/visual equipment, electrical application and instrumentation.
- For equipment/devices where high reliability or safety is required, such as space applications, nuclear power control equipment, medical equipment, etc, please contact our sales representatives.
- When requiring a device for any "specific" application, please contact our sales in advance.
- If there are any questions about the contents of this publication, please contact us at your convenience.
- The contents described herein are subject to change without prior notice.
- Immerge unit's body in solder paste is not recommended.