



Chipsmall Limited consists of a professional team with an average of over 10 year of expertise in the distribution of electronic components. Based in Hongkong, we have already established firm and mutual-benefit business relationships with customers from,Europe,America and south Asia,supplying obsolete and hard-to-find components to meet their specific needs.

With the principle of “Quality Parts,Customers Priority,Honest Operation,and Considerate Service”,our business mainly focus on the distribution of electronic components. Line cards we deal with include Microchip,ALPS,ROHM,Xilinx,Pulse,ON,Everlight and Freescale. Main products comprise IC,Modules,Potentiometer,IC Socket,Relay,Connector.Our parts cover such applications as commercial,industrial, and automotives areas.

We are looking forward to setting up business relationship with you and hope to provide you with the best service and solution. Let us make a better world for our industry!



## Contact us

Tel: +86-755-8981 8866 Fax: +86-755-8427 6832

Email & Skype: info@chipsmall.com Web: www.chipsmall.com

Address: A1208, Overseas Decoration Building, #122 Zhenhua RD., Futian, Shenzhen, China





# LED Middle POWER

## 5630 Product Data Sheet

### *SZPXX Series*

Created Date: 03 / 12 / 2014  
Revision: 2.0, 05 / 9 / 2014



## LED Middle POWER 5630SZPXX Series

### 1. Description

The LiteON 5630 Product series is a wide beam angle standard-dimension package, combining the lifetime and reliability advantages of Light Emitting Diodes with the brightness of conventional lighting. It gives you total design freedom and unmatched brightness, creating a new opportunities for solid state lighting to displace conventional lighting technologies.

#### 1.1 Features

- Package in 8mm tape on 7" diameter reels.
- Compatible with automatic placement equipment.
- Compatible with infrared and vapor phase reflow solder process.
- EIA STD package.
- I.C. compatible.
- Meet green product and Pb-free(According to RoHS)

#### 1.2 Available Part Numbers

CCT	Part Number
6500K	LTW-5630SZP65
5700K	LTW-5630SZP57
5000K	LTW-5630SZP50
4000K	LTW-5630SZP40
3500K	LTW-5630SZP35
3000K	LTW-5630SZP30
2700K	LTW-5630SZP27

## LED Middle POWER 5630SZPXX Series

### 2. Outline Dimensions

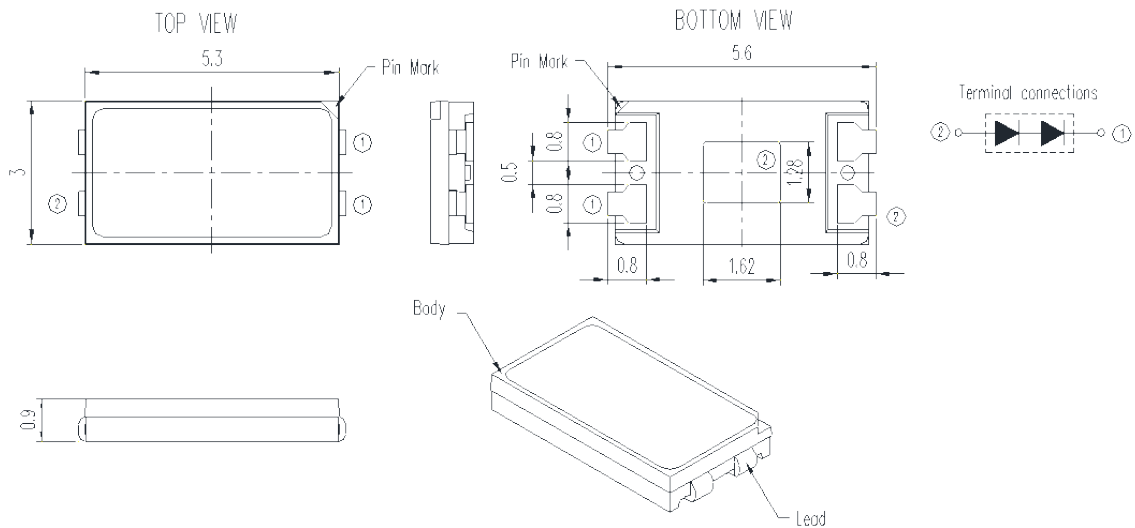

Part No.	Lens Color	Source Color
LTW-5630SZP65	Orange	InGaN Blue
LTW-5630SZP57		
LTW-5630SZP50		
LTW-5630SZP40		
LTW-5630SZP35		
LTW-5630SZP30		
LTW-5630SZP27		

#### Notes:

1. All dimensions are in millimeters.
2. Tolerance is  $\pm 0.2$  mm (.008") unless otherwise noted.

## LED Middle POWER 5630SZPXX Series

### 3. Absolute Maximum Ratings at $T_a=25^{\circ}\text{C}$

Parameter	Symbol	Rating	Unit
Power Dissipation	$P_o$	750	mW
Continuous Forward Current	$I_F$	120	mA
Pulse Forward Current	$I_{FP}$	130	mA
Operating Temperature Range	$T_{opr}$	-40 ~ +85	$^{\circ}\text{C}$
Storage Temperature Range	$T_{stg}$	-40 ~ +100	$^{\circ}\text{C}$
Junction Temperature	$T_j$	$\leq 120$	$^{\circ}\text{C}$

#### Notes :

1. 1/10 duty cycle, Pulse width  $\leq 100 \mu\text{s}$ .
2. Forbid to operating at reverse voltage condition for long.
3. It is recommended to follow de-rating curve to use maximum rating to ensure LED can operated normally.

## LED Middle POWER 5630SZPXX Series

### 4. Electro-Optical Characteristics

#### 4.1 Typical Performance

Parameter	Symbol	Values								Unit	Test Condition
		Typ.	2700	3000	3500	4000	5000	5700	6500		
Correlated Color Temp.	CCT	Typ.	2700	3000	3500	4000	5000	5700	6500	K	
Chromaticity Coordinates	x	Typ.	0.458	0.434	0.408	0.382	0.345	0.329	0.312	-	$I_F = 32.5\text{mA}$
	y	Typ.	0.410	0.403	0.392	0.380	0.355	0.342	0.328		
Luminous Flux <sup>1</sup>	$\Phi_v$	Min	25.2	26.1	27.0	27.0	27.0	27.0	27.0	lm	
		Typ.	28.9	30.4	31.0	31.6	32.0	31.9	31.0		
		Max.	33.0	33.8	34.7	34.7	34.7	34.7	34.7		
Optical Efficiency	$\eta_{opt}$	Typ.	162	171	174	178	180	179	174	lm/W	
Color Rendering Index	CRI	Min.	80						-		
Viewing Angle	$2\theta_{1/2}$	Typ.	120						deg		
Forward Voltage	$V_F$	Min	5.2						V		
		Typ.	5.5								
		Max.	6.0								
Thermal Resistance	$R_{jt}$	Typ.	15						$^{\circ}\text{C}/\text{W}$		
ESD-Withstand Voltage	ESD	Min	2K						HBM	V	

#### Notes

- Luminous flux is the total luminous flux output as measured with an integrating sphere.
- Iv (flux  $\Phi_v$ ) classification code is marked on each packing bag.
- The chromaticity coordinates (x, y) is derived from the 1931 CIE chromaticity diagram.
- Caution in ESD:
  - Static Electricity and surge damages the LED. It is recommended using a wrist band or anti-electrostatic glove when handling the LED. All devices, equipment and machinery must be properly grounded.
- CAS140B is the test standard for the chromaticity coordinates (x, y) &  $\Phi_v$ .
- The chromaticity coordinates (x, y) guarantee should be added +/- 0.01 tolerances
- CRI measurement allowance is  $\pm 5$ , R9 of all CCT is >0.
- The thermal resistance is defined

as the figure,  $R_{jt}$  is the  $R_{th}$  from  $T_j$  to thermal pad solder:

Reference for thermal resistance:

Using 2.5x 2.5x 0.17 cm aluminum MCPCB,

$R_{jt}=15^{\circ}\text{C}/\text{W}$ ,  $R_{js}=19^{\circ}\text{C}/\text{W}$

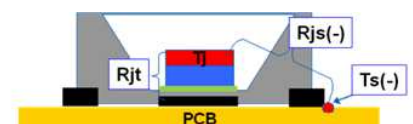

- ◆  $R_{js} = R_{th}$  of  $T_j$  to  $T_s$
- ◆  $R_{jt} = R_{th}$  of  $T_j$  to Thermal pad solder
- ◆  $R_{th}$  definition in Datasheet =  $R_{jt}$
- ◆  $R_{jt} < R_{jc}$
- ◆  $T_j = R_{js} \cdot I_F + T_s$

## LED Middle POWER 5630SZPXX Series

### 4.2 Forward Current vs. Lumen and Voltage

Current (mA)	VF (V)	Lumen (lm)						
		2700K	3000K	3500K	4000K	5000K	5700K	6500K
10.0	5.24	9.1	9.6	9.8	10.0	10.1	10.1	9.8
20.0	5.35	18.0	19.0	19.4	19.8	20.0	19.9	19.4
30.0	5.44	26.8	28.2	28.8	29.3	29.7	29.6	28.8
32.5	5.47	28.9	30.4	31.0	31.6	32.0	31.9	31.0
40.0	5.54	35.1	36.9	37.7	38.4	38.9	38.7	37.7
60.0	5.70	51.0	53.7	54.8	55.9	56.6	56.4	54.8
65.0	5.74	55.0	57.8	59.0	60.2	60.9	60.7	59.0
90.0	5.92	73.3	77.1	78.7	80.3	81.2	80.9	78.7
100.0	5.97	81.1	85.3	87.1	88.8	89.9	89.5	87.1
120.0	6.06	94.0	99.0	101.0	103.0	104.3	103.9	101.0

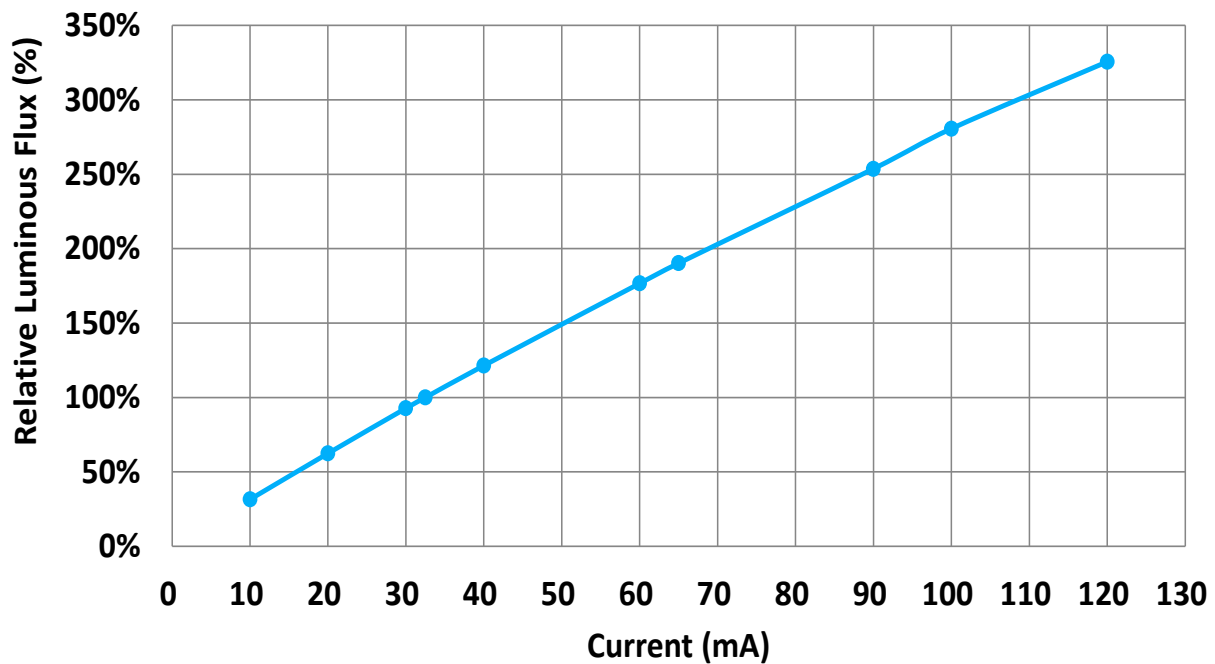

# LED Middle POWER 5630SZPXX Series

## 4.3 Relative Spectral Power Distribution at Typical Current

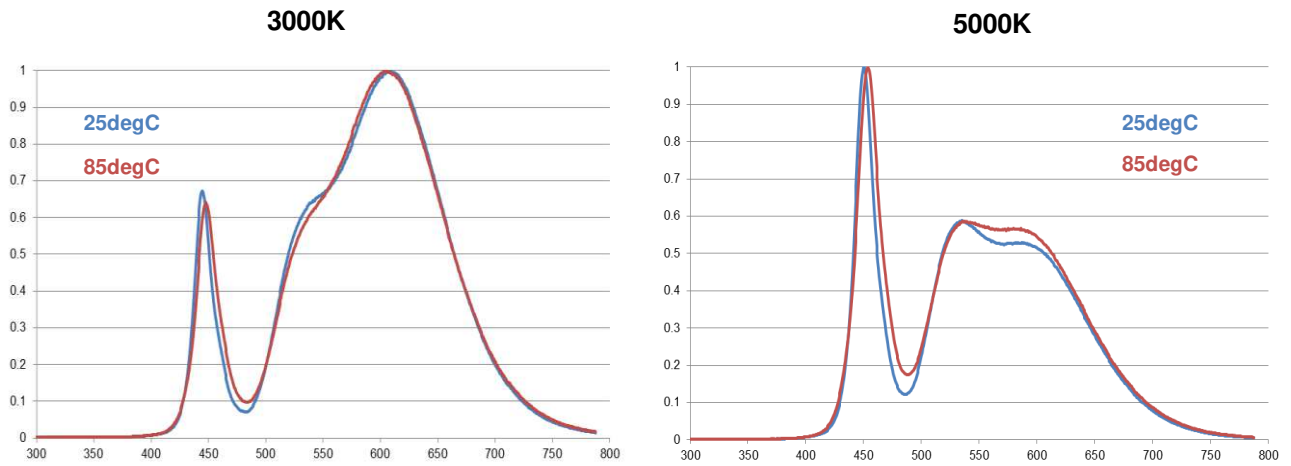

## 4.4 Radiation Characteristics

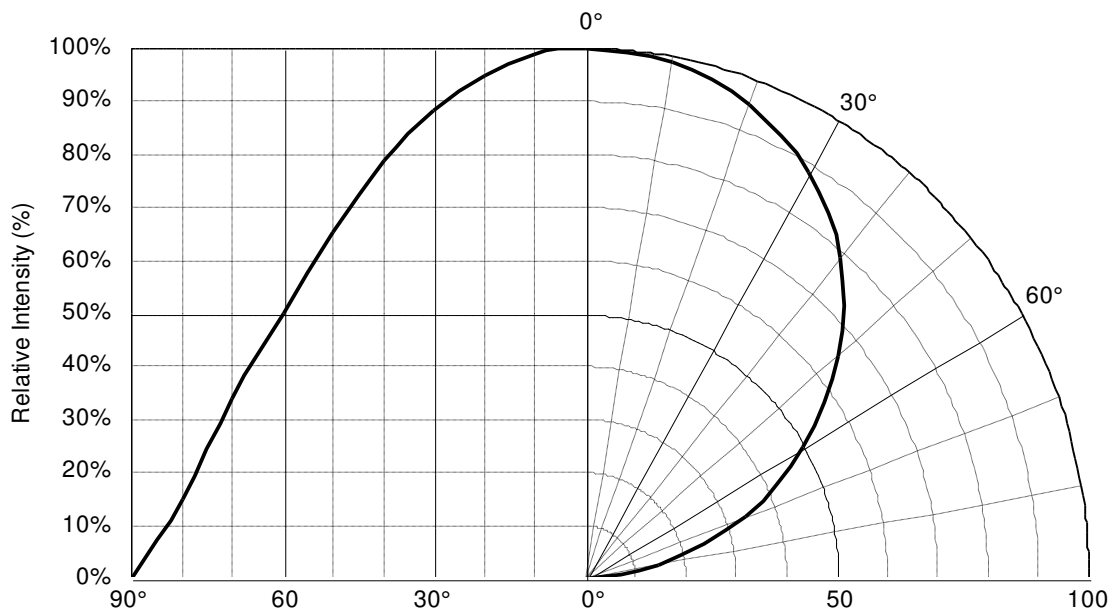



# LED Middle POWER 5630SZPXX Series

## 4.5 Forward Current vs. Forward Voltage

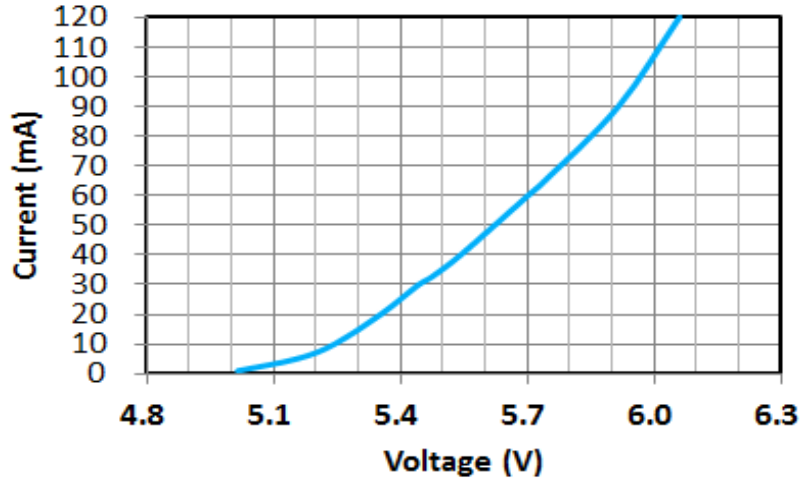

## 4.2 Color Shift vs. Forward Current

### ■ Cool White

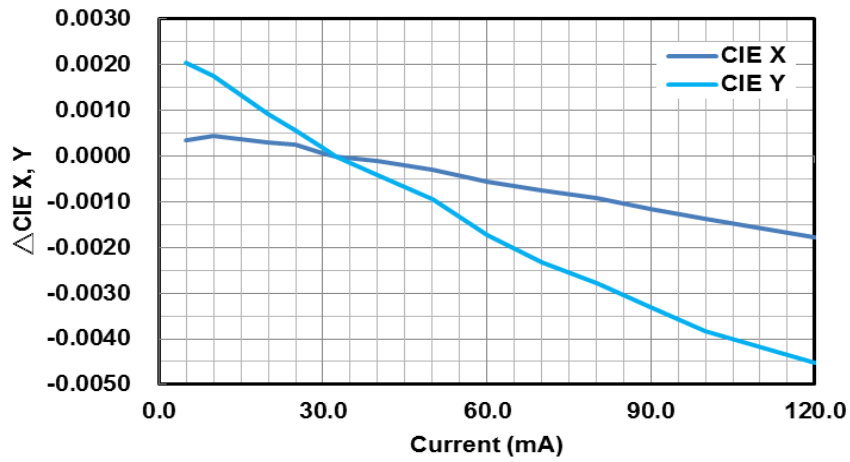

### ■ Warm White

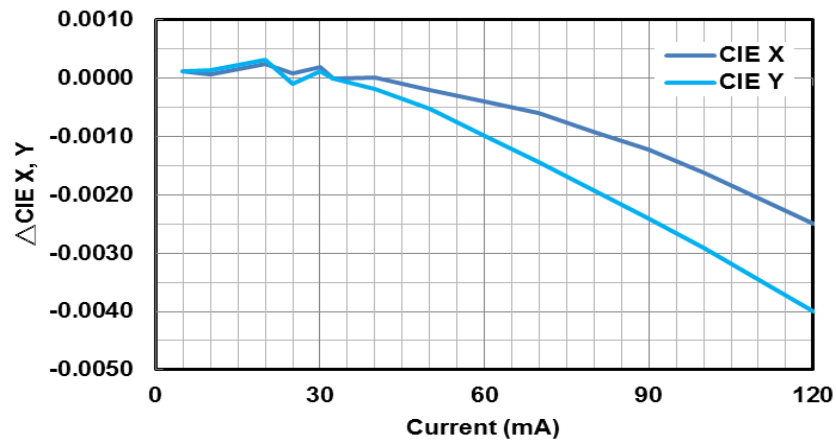

# LED Middle POWER 5630SZPXX Series

## 4.2 Relative Intensity vs. Junction Temperature

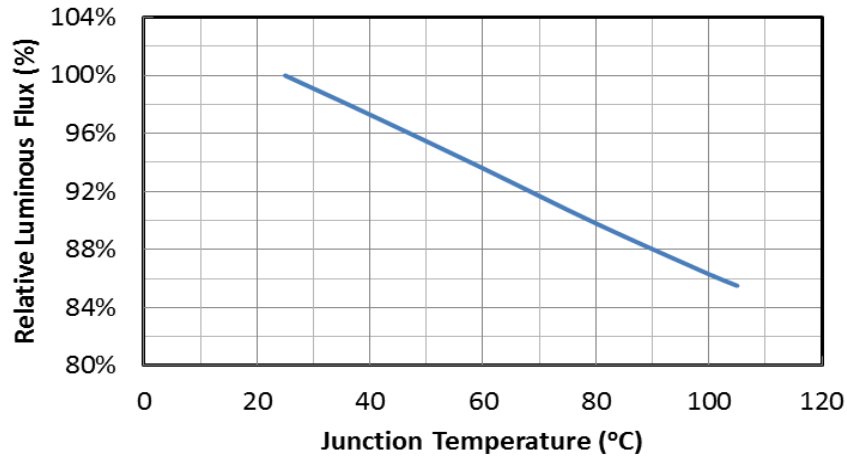

## 4.3 Voltage vs. Junction Temperature

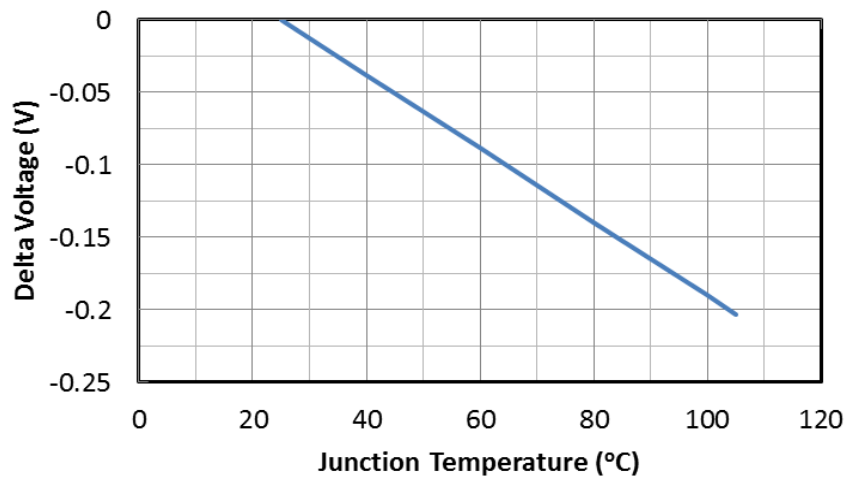

## 4.4 Color Shift vs. Junction Temperature

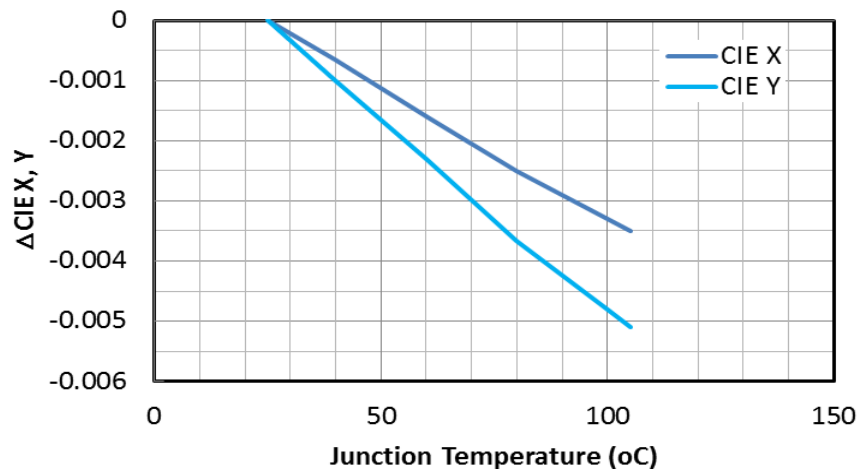

# LED Middle POWER 5630SZPXX Series

## 5. Binning Definition

### 5.1 Color Bin

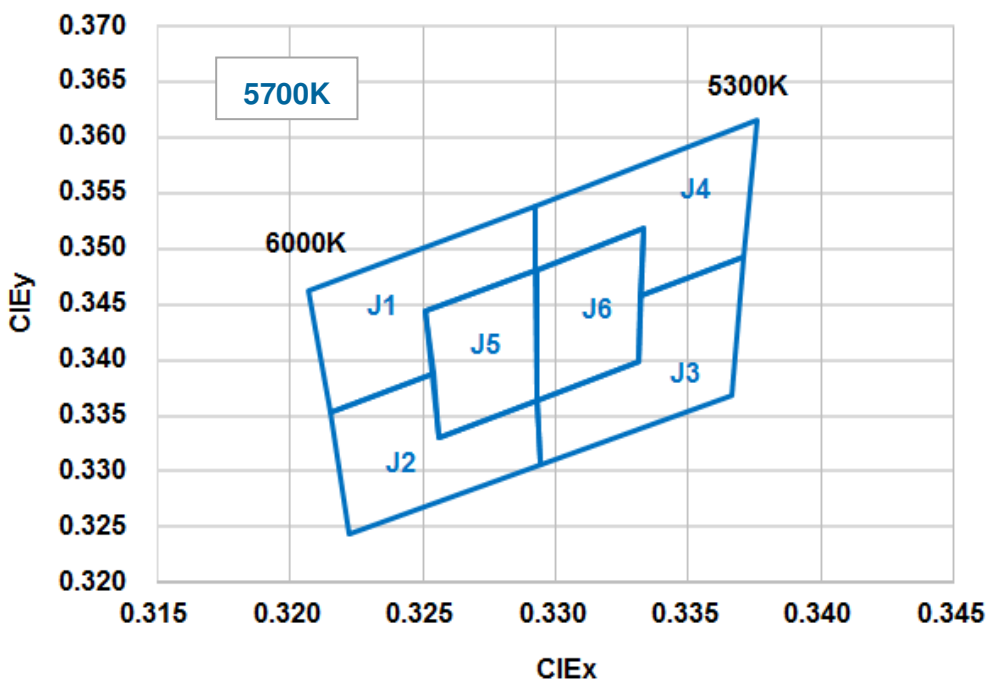
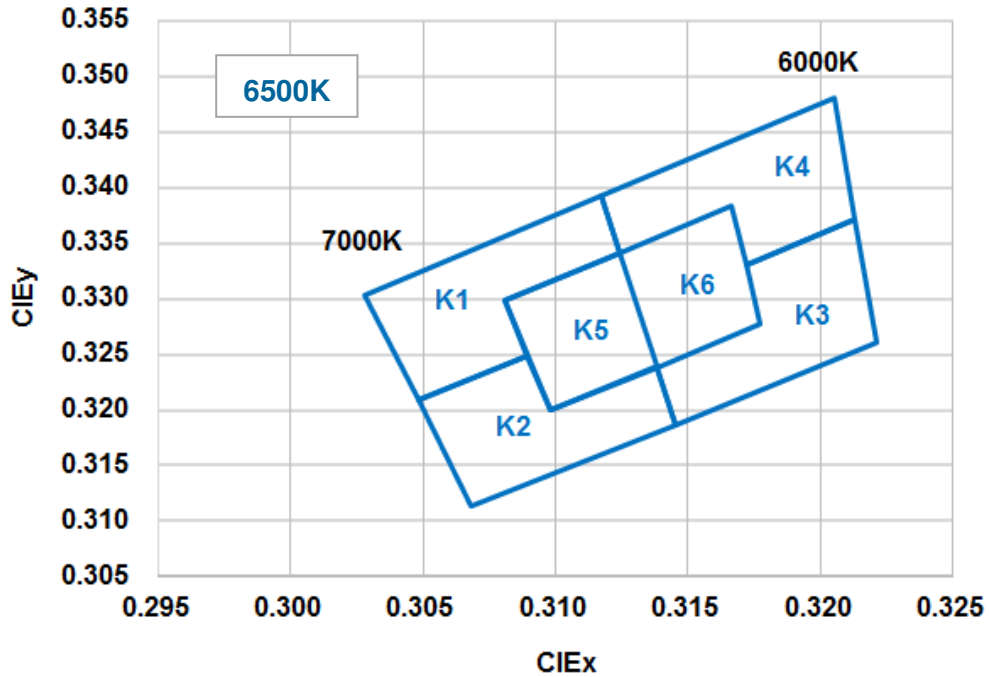



**LED Middle POWER  
5630SZPXX Series**

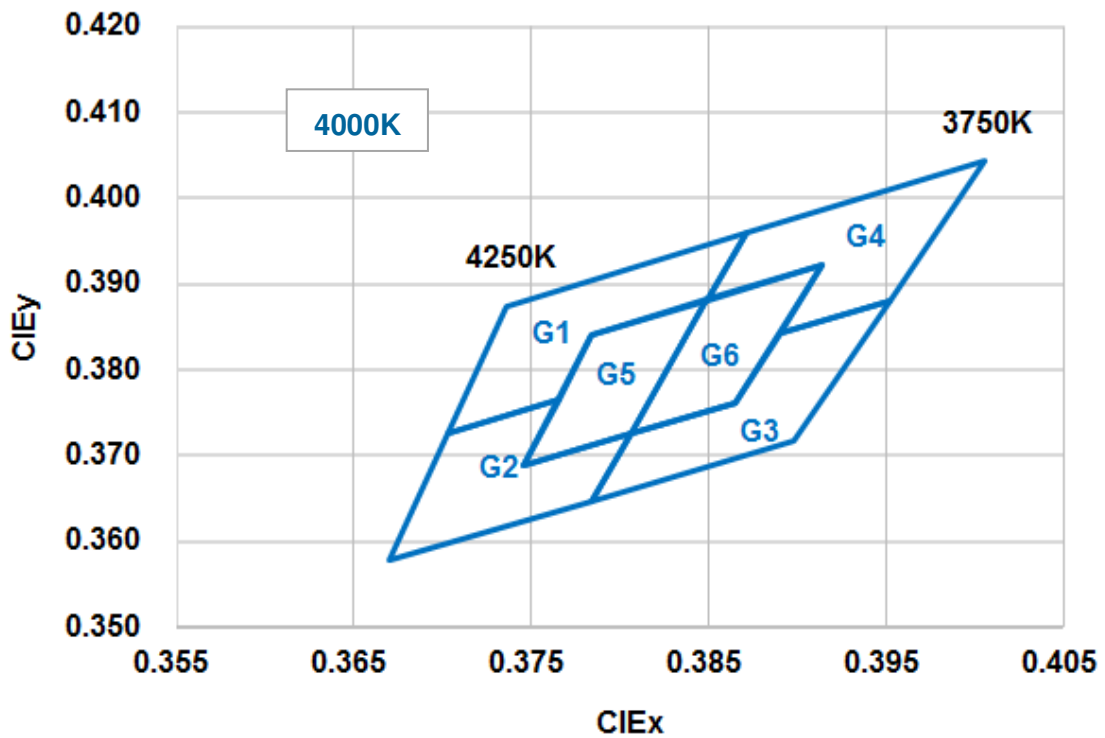
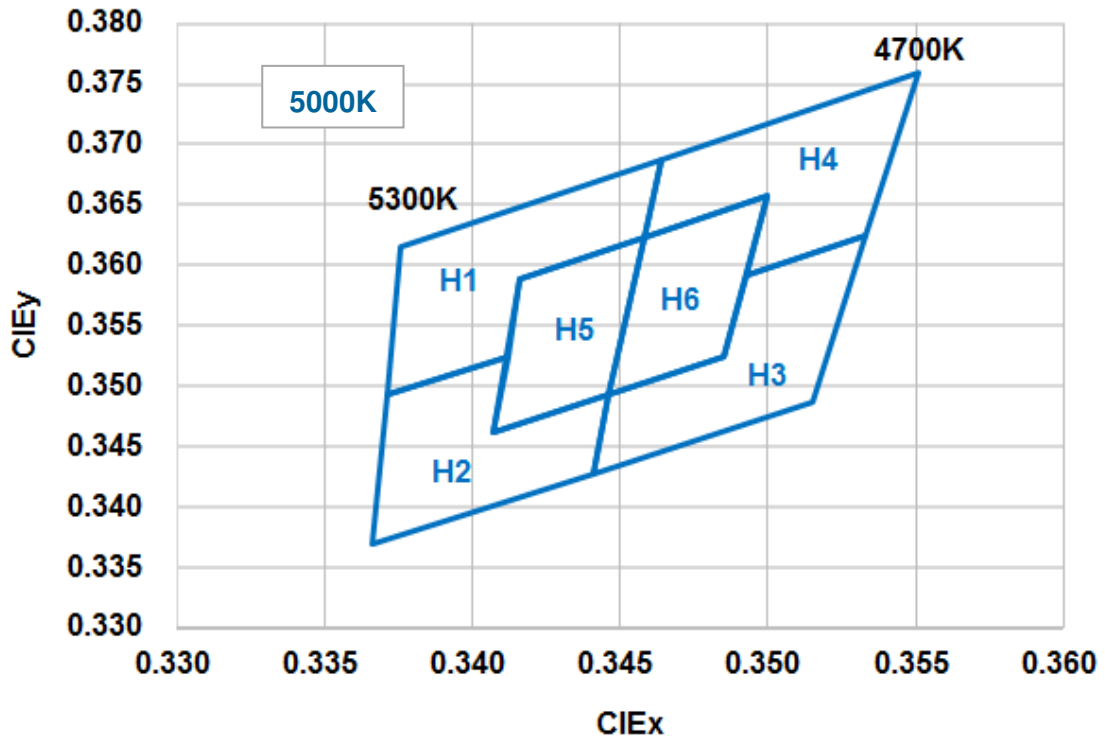

LED Middle POWER  
5630SZPXX Series

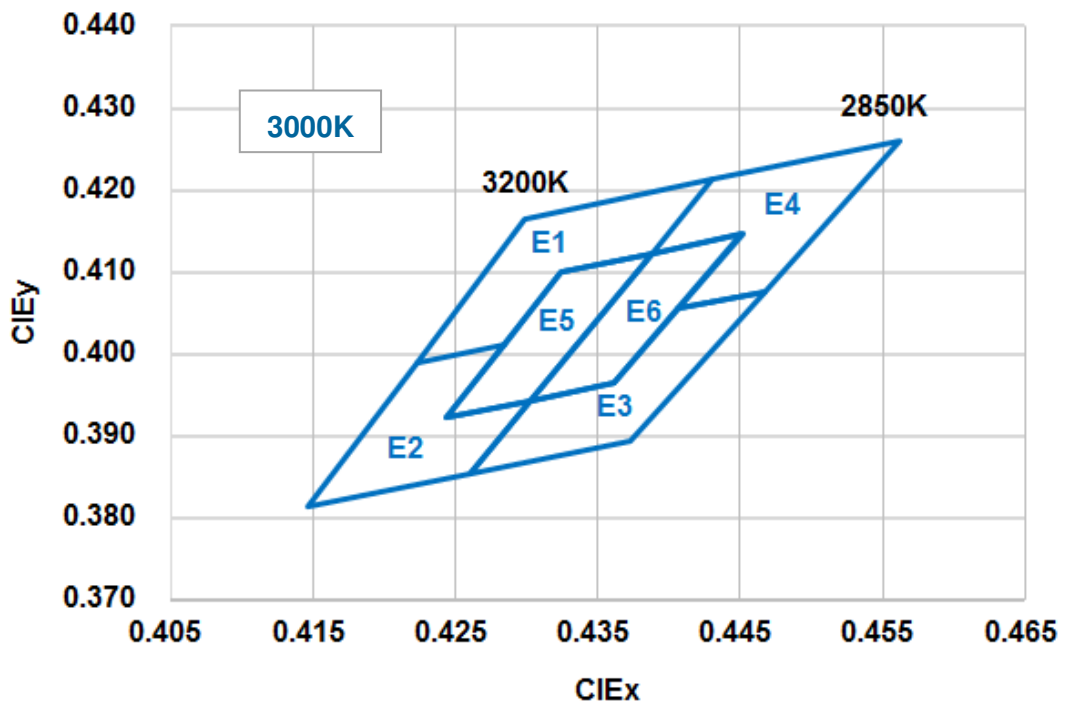
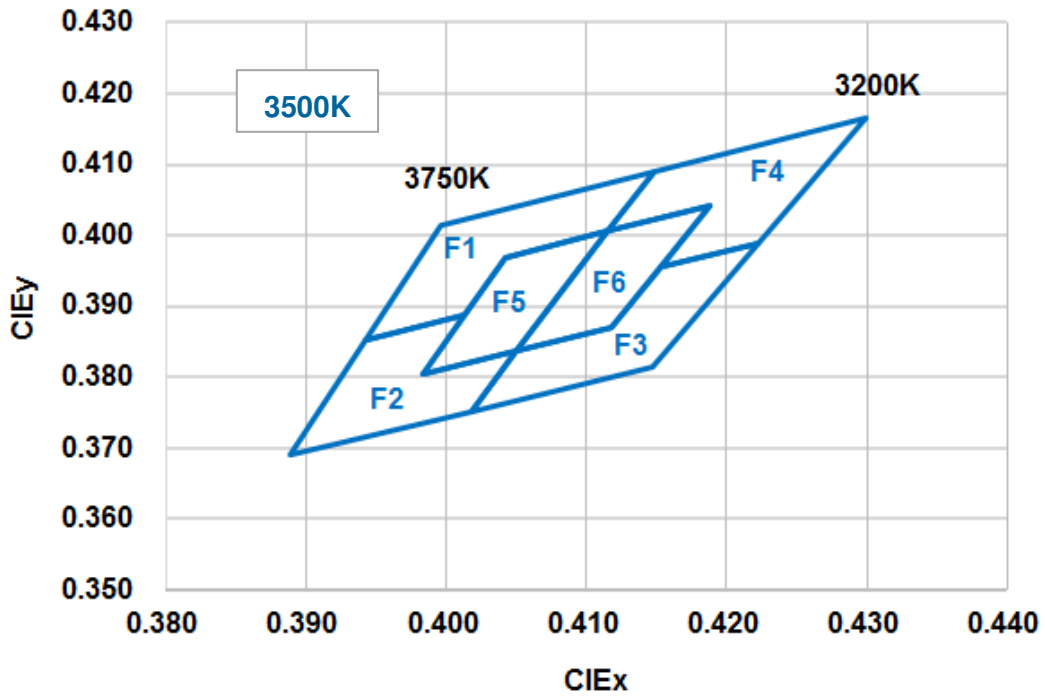



**LED Middle POWER  
5630SZPXX Series**

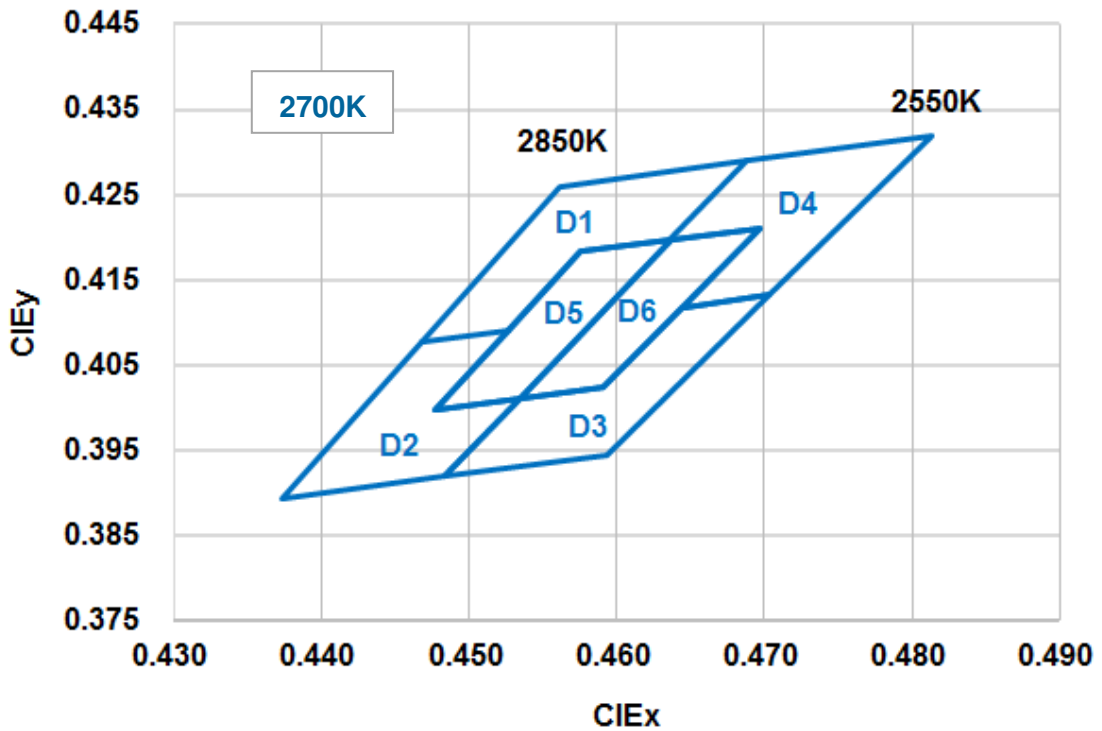

## LED Middle POWER 5630SZPXX Series

### 5.2 Color Rank

6500K ( $I_F = 32.5 \text{ mA}$ )											
Rank	-	x	y	Rank	-	x	y	Rank	-	x	y
K1	1	0.3048	0.3209	K3	1	0.3145	0.3187	K5	1	0.3098	0.320
	2	0.3028	0.3304		2	0.3138	0.3238		2	0.3081	0.3299
	3	0.3117	0.3393		3	0.3177	0.3277		3	0.3124	0.3342
	4	0.3124	0.3341		4	0.3172	0.3330		4	0.3138	0.3239
	5	0.3081	0.3299		5	0.3213	0.3371				
	6	0.3089	0.3249		6	0.3221	0.3261				
K2	1	0.3068	0.3113	K4	1	0.3117	0.3393	K6	1	0.3138	0.3239
	2	0.3048	0.3209		2	0.3205	0.3481		2	0.3124	0.3342
	3	0.3089	0.3249		3	0.3213	0.3371		3	0.3167	0.3384
	4	0.3098	0.32		4	0.3172	0.333		4	0.3178	0.3277
	5	0.3138	0.3238		5	0.3166	0.3384				
	6	0.3145	0.3187		6	0.3124	0.3341				

Tolerance on each Hue bin (x,y) is +/- 0.01.

5700K ( $I_F = 32.5 \text{ mA}$ )											
Rank	-	x	y	Rank	-	x	y	Rank	-	x	y
J1	1	0.3215	0.3353	J3	1	0.3294	0.3306	J5	1	0.3256	0.3331
	2	0.3207	0.3462		2	0.3293	0.3364		2	0.3251	0.3444
	3	0.3292	0.3539		3	0.3331	0.3398		3	0.3292	0.3481
	4	0.3292	0.3481		4	0.3332	0.3458		4	0.3293	0.3364
	5	0.3251	0.3444		5	0.3371	0.3493				
	6	0.3254	0.3388		6	0.3366	0.3369				
J2	1	0.3222	0.3243	J4	1	0.3292	0.3539	J6	1	0.3293	0.3364
	2	0.3215	0.3353		2	0.3376	0.3616		2	0.3293	0.3481
	3	0.3254	0.3388		3	0.3371	0.3493		3	0.3333	0.3518
	4	0.3256	0.3331		4	0.3332	0.3458		4	0.3331	0.3398
	5	0.3293	0.3364		5	0.3333	0.3518				
	6	0.3294	0.3306		6	0.3292	0.3481				

Tolerance on each Hue bin (x,y) is +/- 0.01.

## LED Middle POWER 5630SZPXX Series

5000K ( $I_F = 32.5$ mA)											
Rank	-	x	y	Rank	-	x	y	Rank	-	x	y
<b>H1</b>	1	0.3371	0.3493	<b>H3</b>	1	0.3441	0.3428	<b>H5</b>	1	0.3407	0.3462
	2	0.3376	0.3616		2	0.3446	0.3493		2	0.3416	0.3589
	3	0.3464	0.3688		3	0.3485	0.3524		3	0.3458	0.3623
	4	0.3458	0.3623		4	0.3493	0.3591		4	0.3446	0.3493
	5	0.3416	0.3589		5	0.3533	0.3624				
	6	0.3412	0.3525		6	0.3515	0.3487				
<b>H2</b>	1	0.3366	0.3369	<b>H4</b>	1	0.3464	0.3688	<b>H6</b>	1	0.3446	0.3493
	2	0.3371	0.3493		2	0.3551	0.3760		2	0.3458	0.3623
	3	0.3412	0.3525		3	0.3533	0.3624		3	0.3500	0.3657
	4	0.3407	0.3462		4	0.3493	0.3591		4	0.3485	0.3524
	5	0.3446	0.3493		5	0.3500	0.3657				
	6	0.3441	0.3428		6	0.3458	0.3623				

Tolerance on each Hue bin (x,y) is +/- 0.01.

4000K ( $I_F = 32.5$ mA)											
Rank	-	x	y	Rank	-	x	y	Rank	-	x	y
<b>G1</b>	1	0.3703	0.3726	<b>G3</b>	1	0.3784	0.3647	<b>G5</b>	1	0.3746	0.3689
	2	0.3736	0.3874		2	0.3806	0.3725		2	0.3784	0.3841
	3	0.3871	0.3959		3	0.3865	0.3762		3	0.3849	0.3882
	4	0.3849	0.3881		4	0.3890	0.3842		4	0.3806	0.3726
	5	0.3784	0.3841		5	0.3952	0.3880				
	6	0.3766	0.3765		6	0.3898	0.3716				
<b>G2</b>	1	0.3670	0.3578	<b>G4</b>	1	0.3871	0.3959	<b>G6</b>	1	0.3806	0.3726
	2	0.3703	0.3726		2	0.4006	0.4044		2	0.3849	0.3882
	3	0.3766	0.3765		3	0.3952	0.3880		3	0.3914	0.3922
	4	0.3746	0.3689		4	0.3890	0.3842		4	0.3865	0.3762
	5	0.3806	0.3725		5	0.3914	0.3922				
	6	0.3784	0.3647		6	0.3849	0.3881				

Tolerance on each Hue bin (x,y) is +/- 0.01.



## LED Middle POWER 5630SZPXX Series

3500K ( $I_F = 32.5 \text{ mA}$ )											
Rank	-	x	y	Rank	-	x	y	Rank	-	x	y
<b>F1</b>	1	0.3943	0.3853	<b>F3</b>	1	0.4018	0.3752	<b>F5</b>	1	0.3983	0.3804
	2	0.3996	0.4015		2	0.4050	0.3837		2	0.4042	0.3970
	3	0.4148	0.4090		3	0.4118	0.3869		3	0.4115	0.4006
	4	0.4115	0.4006		4	0.4153	0.3955		4	0.4050	0.3837
	5	0.4042	0.3970		5	0.4223	0.3990				
	6	0.4013	0.3887		6	0.4147	0.3814				
<b>F2</b>	1	0.3889	0.3690	<b>F4</b>	1	0.4148	0.4090	<b>F6</b>	1	0.4050	0.3837
	2	0.3943	0.3853		2	0.4299	0.4165		2	0.4115	0.4006
	3	0.4013	0.3887		3	0.4223	0.3990		3	0.4188	0.4041
	4	0.3983	0.3804		4	0.4153	0.3955		4	0.4118	0.3869
	5	0.4050	0.3837		5	0.4188	0.4041				
	6	0.4018	0.3752		6	0.4115	0.4006				

Tolerance on each Hue bin (x,y) is +/- 0.01.

3000K ( $I_F = 32.5 \text{ mA}$ )											
Rank	-	x	y	Rank	-	x	y	Rank	-	x	y
<b>E1</b>	1	0.4223	0.3990	<b>E3</b>	1	0.4260	0.3854	<b>E5</b>	1	0.4244	0.3923
	2	0.4299	0.4165		2	0.4303	0.3943		2	0.4324	0.4100
	3	0.4431	0.4213		3	0.4361	0.3964		3	0.4388	0.4123
	4	0.4388	0.4123		4	0.4406	0.4055		4	0.4303	0.3944
	5	0.4324	0.4100		5	0.4468	0.4077				
	6	0.4284	0.4011		6	0.4373	0.3893				
<b>E2</b>	1	0.4147	0.3814	<b>E4</b>	1	0.4431	0.4213	<b>E6</b>	1	0.4303	0.3944
	2	0.4223	0.3990		2	0.4562	0.4260		2	0.4388	0.4123
	3	0.4284	0.4011		3	0.4468	0.4077		3	0.4452	0.4146
	4	0.4244	0.3923		4	0.4406	0.4055		4	0.4361	0.3964
	5	0.4303	0.3943		5	0.4451	0.4146				
	6	0.4260	0.3854		6	0.4388	0.4123				

9

Tolerance on each Hue bin (x,y) is +/- 0.01.

## LED Middle POWER 5630SZPXX Series

2700K ( $I_f = 32.5 \text{ mA}$ )											
Rank	-	x	y	Rank	-	x	y	Rank	-	x	y
<b>D1</b>	1	0.4468	0.4077	<b>D3</b>	1	0.4483	0.3919	<b>D5</b>	1	0.4477	0.3998
	2	0.4562	0.4260		2	0.4534	0.4011		2	0.4576	0.4183
	3	0.4688	0.4290		3	0.4591	0.4025		3	0.4637	0.4197
	4	0.4636	0.4197		4	0.4644	0.4118		4	0.4534	0.4012
	5	0.4576	0.4183		5	0.4703	0.4132				
	6	0.4527	0.4090		6	0.4593	0.3944				
<b>D2</b>	1	0.4373	0.3893	<b>D4</b>	1	0.4688	0.4290	<b>D6</b>	1	0.4534	0.4012
	2	0.4468	0.4077		2	0.4813	0.4319		2	0.4637	0.4197
	3	0.4527	0.4090		3	0.4703	0.4132		3	0.4697	0.4211
	4	0.4477	0.3998		4	0.4644	0.4118		4	0.4591	0.4025
	5	0.4534	0.4011		5	0.4697	0.4211				
	6	0.4483	0.3919		6	0.4636	0.4197				

Tolerance on each Hue bin (x,y) is +/- 0.01.

## LED Middle POWER 5630SZPXX Series

### 5.3 Flux Bin

2700K	$\Phi_v$ Luminous Flux Spec. Table	
$\Phi_v$ Bin	Lumen (lm) at $I_F = 32.5$ mA	
	Min	Max
FH	25.2	26.8
HL	26.8	30.5
LO	30.5	33.0

4000K	$\Phi_v$ Luminous Flux Spec. Table	
$\Phi_v$ Bin	Lumen (lm) at $I_F = 32.5$ mA	
	Min	Max
HK	27.0	29.7
KN	29.7	32.2
NQ	32.2	34.7

3000K	$\Phi_v$ Luminous Flux Spec. Table	
$\Phi_v$ Bin	Lumen (lm) at $I_F = 32.5$ mA	
	Min	Max
GJ	26.1	28.8
JM	28.8	31.3
MP	31.3	33.8

5000K	$\Phi_v$ Luminous Flux Spec. Table	
$\Phi_v$ Bin	Lumen (lm) at $I_F = 32.5$ mA	
	Min	Max
HK	27.0	29.7
KN	29.7	32.2
NQ	32.2	34.7

3500K	$\Phi_v$ Luminous Flux Spec. Table	
$\Phi_v$ Bin	Lumen (lm) at $I_F = 32.5$ mA	
	Min	Max
HK	27.0	29.7
KN	29.7	32.2
NQ	32.2	34.7

5700K	$\Phi_v$ Luminous Flux Spec. Table	
$\Phi_v$ Bin	Lumen (lm) at $I_F = 32.5$ mA	
	Min	Max
HK	27.0	29.7
KN	29.7	32.2
NQ	32.2	34.7

6500K	$\Phi_v$ Luminous Flux Spec. Table	
$\Phi_v$ Bin	Lumen (lm) at $I_F = 32.5$ mA	
	Min	Max
HK	27.0	29.7
KN	29.7	32.2
NQ	32.2	34.7

Tolerance on each Luminous Flux bin is +/- 10%.

## LED Middle POWER 5630SZPXX Series

### 5.4 Voltage Bin

V <sub>F</sub> Spec. Table		
V <sub>F</sub> Bin	Forward Voltage (volts) at I <sub>F</sub> = 32.5 mA	
	Min	Max
V1	5.2	5.4
V2	5.4	5.6
V3	5.6	5.8
V4	5.8	6.0

Tolerance on each Forward Voltage bin is +/- 0.1V

### 6. Bin Code List

※ Notes: Full Rank on Label

Example: V1 / KN / G5

Forward Voltage Rank	Luminous Flux Rank	Color Rank
V1	KN	G5

## LED Middle POWER 5630SZPXX Series

### 7. Reflow Soldering Characteristics

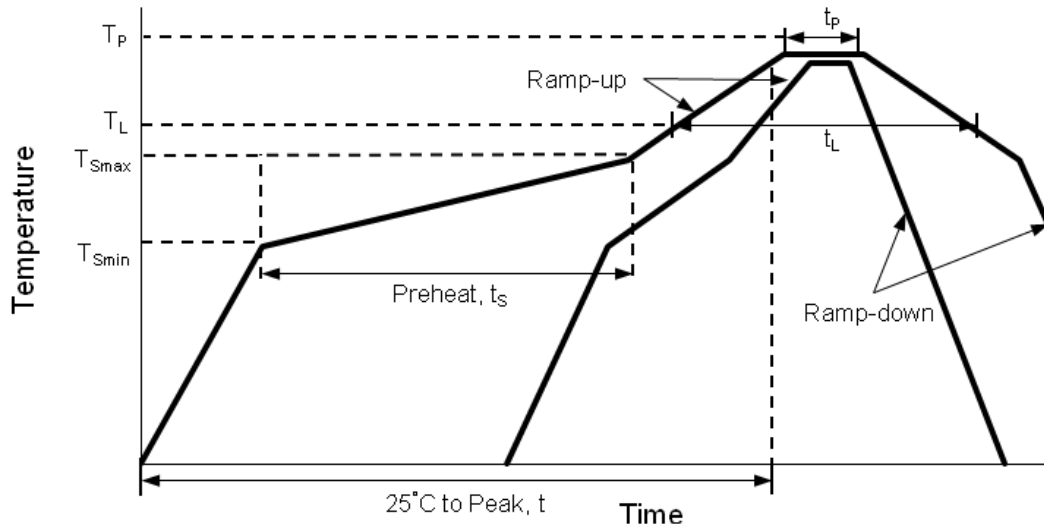

Profile Feature	Lead Free Assembly
Average Ramp-Up Rate ( $T_{Smax}$ to $T_P$ )	3°C / second max
Preheat Temperature Min ( $T_{Smin}$ )	150°C
Preheat Temperature Max ( $T_{Smax}$ )	200°C
Preheat Time ( $t_{Smin}$ to $t_{Smax}$ )	60 – 180 seconds
Time Maintained Above Temperature ( $T_L$ )	217°C
Time Maintained Above Time ( $t_L$ )	60 – 150 seconds
Peak / Classification Temperature ( $T_P$ )	260°C
Time Within 5°C of Actual Peak Temperature ( $t_P$ )	5 seconds
Ramp – Down Rate	6°C / second max
Time 25°C to Peak Temperature	8 minutes max

#### Notes:

- The LEDs can be soldered using the reflow soldering or hand soldering method. The recommended hand soldering condition is 350 °C max. and 2 secs max. for one time only, and the recommended reflow soldering condition is 260 °C max. and 5 secs max. for three times max.
- All temperatures refer to topside of the package, measured on the package body surface.

## LED Middle POWER 5630SZPXX Series

3. The soldering condition referring to J-STD-020B. The storage ambient for the LEDs should not exceed 30 °C temperature or 70% relative humidity. It is recommended that LEDs out of their original packaging are soldered within one week. For extended storage out of their original packaging, it is recommended that the LEDs were stored in a sealed container with appropriate desiccant, or desiccators with nitrogen ambient. If the LEDs were unpacked more than 168hrs, baking the LEDs at 60 °C for 24hrs before soldering process.
4. The soldering profile could be further referred to different soldering grease material characteristic. The grease vendor will provide this information.
5. A rapid-rate process is not recommended for the LEDs cooling down from the peak temperature.
6. Although the recommended reflow conditions are specified above, the reflow or hand soldering condition at the lowest possible temperature is desirable for the LEDs.
7. LiteOn cannot make a guarantee on the LEDs which have been already assembled using the dip soldering method.

## LED Middle POWER 5630SZPXX Series

### 8. Reliability Test

No	Test item	Test Condition	Duration	Number of Damaged
1	Steady State Operating Life of High Temperature (HTOL)	Ts=55°C, I <sub>F</sub> =60 mA	1000 hrs	0/20
2	Steady State Operating Life of High Temperature (HTOL)	Ts=85°C, I <sub>F</sub> =60 mA	1000 hrs	0/20
3	Steady State Operating Life of Low Temperature (LTOL)	Ta=-40°C, I <sub>F</sub> =60 mA	1000 hrs	0/20
4	Pulse Wet Operating Life of High Temperature (PWHTOL)	60°C/90%RH, I <sub>F</sub> =60 mA 30mins ON/30min OFF	500 hrs	0/20
5	High Temperature Storage (HTS)	100°C	1000 hrs	0/20
6	Low Temperature Storage (LTS)	-40°C	1000 hrs	0/20
7	Thermal Cycle (TC)	-40°C~100°C 30min dwell 5min transfer	200 cycles	0/20
8	Thermal Shock (TS)	-40°C~100°C 20min dwell 20sec transfer	200 cycles	0/20
9	Solder Resistance (SR)	265°C, 3X MSL	5sec	0/20
10	Solder Ability (SA)	245°C 5sec, 95% coverage	5sec	0/11
11	Mechanical Shock (MS)	1500G 0.5msec pulse shock	each 6 axis	0/6
12	Random Vibration (RV)	6G RMS, 10-2000Hz, 10min	per axis	0/6
13	Variable Vibration Frequency (VVF)	10-2000-10Hz, log or linear sweep rate, 20G for 1 min, 1.5mm each apply 3x per axis	over 6hrs	0/6
14	Salt Spread (SS)	35°C, 30g/m <sup>2</sup> /day	48hrs	0/11

■ Criteria for Judging the Damage

Item	Symbol	Test Condition	Criteria for Judgment	
			Min.	Max.
Forward Voltage	V <sub>F</sub>	I <sub>F</sub> =Typical Current		U.S.L. x 1.1
Luminous Flux	Im	I <sub>F</sub> =Typical Current	L.S.L. x 0.7	
CCX&CCY	x,y	I <sub>F</sub> =Typical Current		Shift<0.02

## LED Middle POWER 5630SZPXX Series

### 9. User Guide

#### ■ Cleaning

Do not use unspecified chemical liquid to clean LED they could harm the package. If cleaning is necessary, immerse the LED in ethyl alcohol or isopropyl alcohol at normal temperature for less than one minute.

#### ■ Recommend Printed Circuit Board Attachment Pad

Infrared / vapor phase

Reflow Soldering

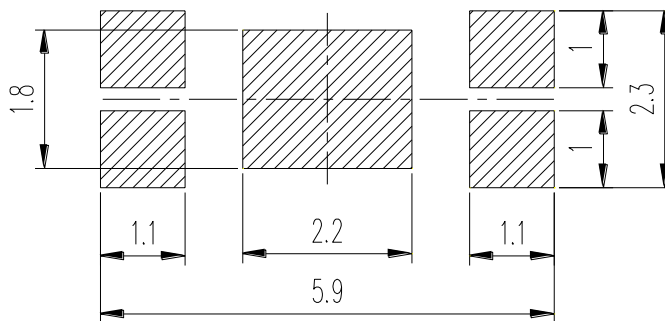

#### ■ Package Dimensions of Tape

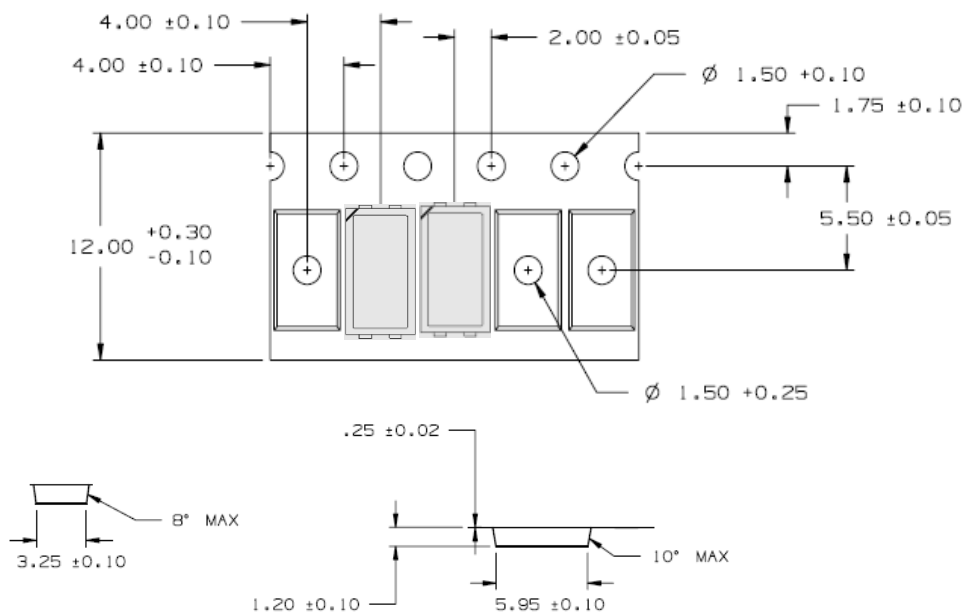

**Note:** All dimensions are in millimeters (inches).

#### ■ Package Dimensions of Reel



## LED Middle POWER 5630SZPXX Series

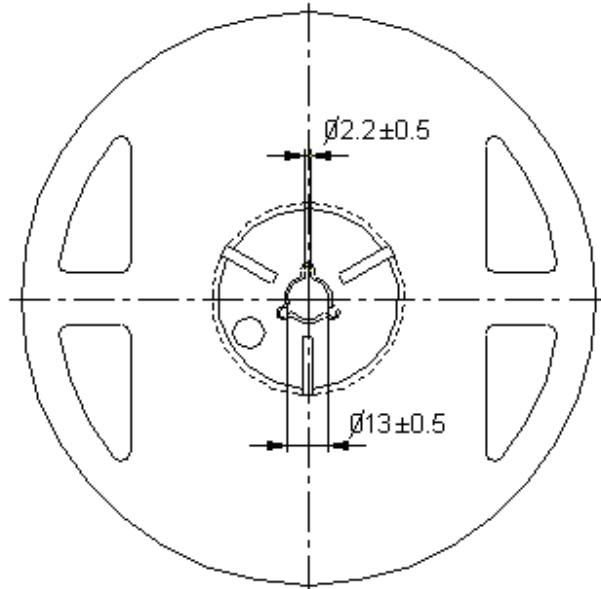

Note: Q1. The tolerance unless mentioned is  $\pm 0.1\text{mm}$   
 Q2. The measured unit is "mm"

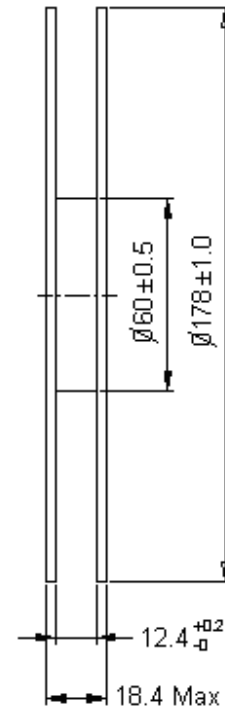

### Notes:

1. Empty component pockets sealed with top cover tape.
2. 7 inch reel-3000 pieces per reel.
3. Minimum packing quantity is 500 pieces for remainders.
4. The maximum number of consecutive missing lamps is two.
5. In accordance with EIA-481-1-B specifications.

## LED Middle POWER 5630SZPXX Series

### 10. Cautions

#### 10.1 Application

The LEDs described here are intended to be used for ordinary electronic equipment (such as office equipment, communication equipment and household applications). Consult Liteon's Sales in advance for information on applications in which exceptional reliability is required, particularly when the failure or malfunction of the LEDs may directly jeopardize life or health (such as in aviation, transportation, traffic control equipment, medical and life support systems and safety devices).

#### 10.2 Storage

This product is qualified as Moisture sensitive Level 3 per JEDEC J-STD-020 Precaution when handling this moisture sensitive product is important to ensure the reliability of the product.

The package is sealed:

The LEDs should be stored at 30°C or less and 90%RH or less. And the LEDs are limited to use within one year, while the LEDs is packed in moisture-proof package with the desiccants inside.

The package is opened:

The LEDs should be stored at 30°C or less and 60%RH or less. Moreover, the LEDs are limited to solder process within 168hrs. If the Humidity Indicator shows the pink color in 10% even higher or exceed the storage limiting time since opened, that we recommended to baking LEDs at 60°C at least 24hrs. To seal the remainder LEDs return to package, it's recommended to be with workable desiccants in original package.

#### 10.3 Cleaning

Use alcohol-based cleaning solvents such as isopropyl alcohol to clean the LED if necessary.

#### 10.4 Drive Mode

An LED is a current-operated device. In order to ensure intensity uniformity on multiple LEDs connected in parallel in an application, it is recommended that a current limiting resistor be incorporated in the drive circuit, in series with each LED as shown in Circuit A below

