



Chipsmall Limited consists of a professional team with an average of over 10 year of expertise in the distribution of electronic components. Based in Hongkong, we have already established firm and mutual-benefit business relationships with customers from,Europe,America and south Asia,supplying obsolete and hard-to-find components to meet their specific needs.

With the principle of “Quality Parts,Customers Priority,Honest Operation,and Considerate Service”,our business mainly focus on the distribution of electronic components. Line cards we deal with include Microchip,ALPS,ROHM,Xilinx,Pulse,ON,Everlight and Freescale. Main products comprise IC,Modules,Potentiometer,IC Socket,Relay,Connector.Our parts cover such applications as commercial,industrial, and automotives areas.

We are looking forward to setting up business relationship with you and hope to provide you with the best service and solution. Let us make a better world for our industry!



Contact us

Tel: +86-755-8981 8866 Fax: +86-755-8427 6832

Email & Skype: info@chipsmall.com Web: www.chipsmall.com

Address: A1208, Overseas Decoration Building, #122 Zhenhua RD., Futian, Shenzhen, China





SMD LED

Product Data Sheet

LTW-M140ZVS

Spec No.: DS22-2012-0106

Effective Date: 12/12/2013

Revision: A

LITE-ON DCC

RELEASE

BNS-OD-FC001/A4

SMD Lamp LTW-M140ZVS

1. Description

The LTW (LiteOn White PLCC LED) is a revolutionary, energy efficient and ultra compact new light source, combining the lifetime and reliability advantages of Light Emitting Diodes with the brightness of conventional lighting. It gives you total design freedom and unmatched brightness, creating a new opportunities for solid state lighting to displace conventional lighting technologies..

1. Features

- High power LED light source
- Instant light (less than 100 ns)
- Low voltage DC operated
- Low thermal resistance
- RoHS Compliant
- Lead free reflow solder compatible

1.2. Applications

- Reading lights (car, bus, aircraft)
- Portable (flashlight, bicycle)
- Downlighters/Orientation
- Decorative/Entertainment
- Bollards/Security/Garden
- Cove/Undershef/Task
- Traffic signaling/Beacons/ Rail crossing and Wayside
- Indoor/Outdoor Commercial and Residential Architectural
- Edge_lit signs (Exit, point of sale)

2. Outline Dimensions

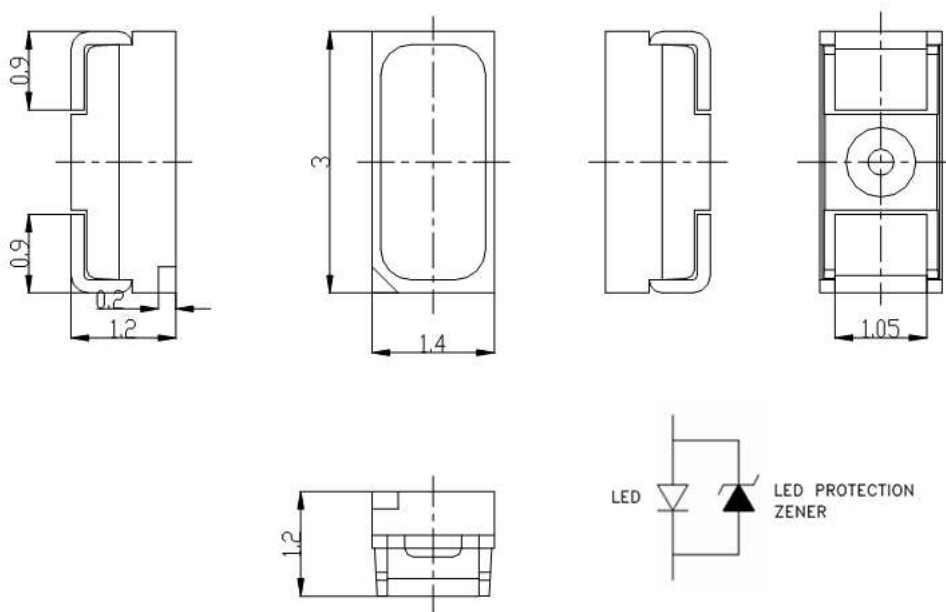

Notes :

1. All dimensions are in millimeters.
2. Tolerance is ± 0.1 mm (.008") unless otherwise noted.

**SMD Lamp
LTW-M140ZVS**

Absolute Maximum Ratings at Ta=25°C

| Parameter | LTW-M140ZVS | Unit |
|--|---------------------|------|
| Power Dissipation | 120 | mW |
| Peak Forward Current (1/10 Duty Cycle, 0.1ms Pulse Width) | 100 | mA |
| DC Forward Current | 30 | mA |
| Reverse Voltage | 5 | V |
| Operating Temperature Range | -30°C to +85°C | |
| Storage Temperature Range | -40°C to +100°C | |
| Reflow Soldering Condition | 260°C For 5 Seconds | |

Note: Operating the LED (in an application) under reverse bias condition might result in damage or failure of the component.

Suggest IR Reflow Condition :

R-Reflow Soldering Profile for lead free soldering (Acc. to J-STD-020)

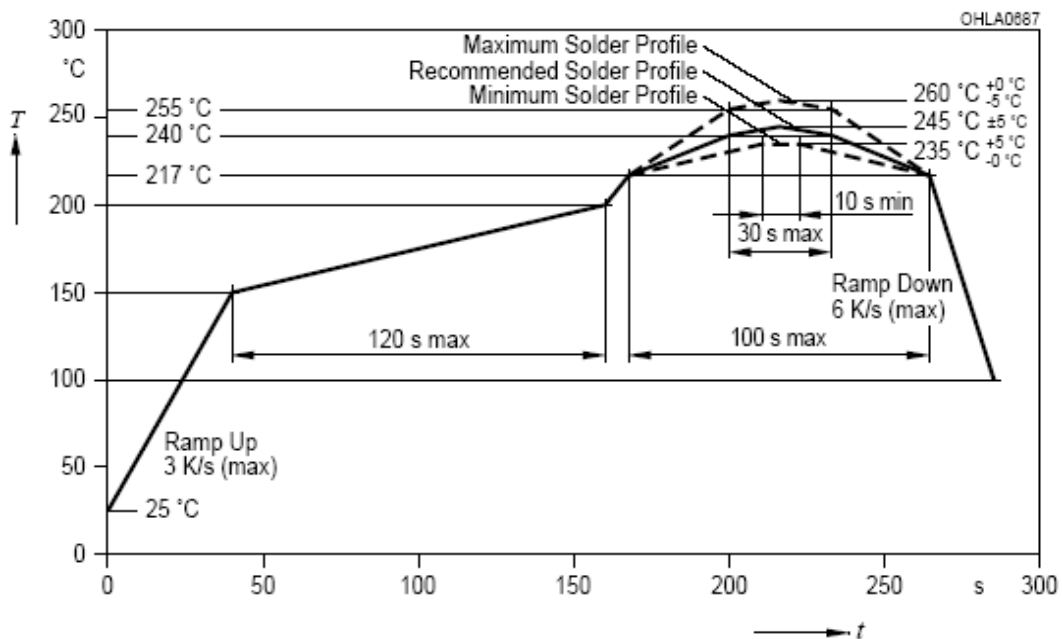

SMD Lamp LTW-M140ZVS

Electro-Optical Characteristics at Ta=25°C

| Parameter | Symbol | Part No. LTW- | Min. | Typ. | Max. | Unit | Test Condition |
|--------------------------|-----------------|------------------|------|-------|------|------|---------------------------------|
| Luminous Flux | Φ_v | M140ZVS | 4.9 | | 8.0 | lm | IF = 20mA Note 1, 2, 5 |
| Viewing Angle | $2\theta_{1/2}$ | M140ZVS | | 120 | | deg | Fig.6 |
| Chromaticity Coordinates | x | M140ZVS | | 0.296 | | | IF = 20mA Note 3, 5 Fig.1 |
| | y | | | 0.285 | | | |
| Forward Voltage | VF | M140ZVS | 2.9 | | 3.5 | V | IF = 20mA |
| Forward Voltage | V _{F1} | M140ZVS | 2.1 | | 3.2 | V | I _F = 1 μ A |
| ESD-Withstand Voltage | ESD | M140ZVS | 2K | | | V | HBM |

Notes:

- Luminous flux is measured with a light sensor and filter combination that approximates the CIE eye-response curve.
- Lm classification code is marked on each packing bag.
- The chromaticity coordinates (x, y) is derived from the 1931 CIE chromaticity diagram.
- Caution in ESD:
Static Electricity and surge damages the LED. It is recommend to use a wrist band or anti-Static glove when handling the LED. All devices, equipment and machinery must be properly grounded.
- CAS140B is the test standard for the chromaticity coordinates (x, y) & lm.

**SMD Lamp
LTW-M140ZVS**

Bin Code List

| Luminous Flux Spec. Table | | |
|---------------------------|-------------------------------------|------|
| IV Bin | Flux (lm) and IV (mcd) at IF = 20mA | |
| | lm | |
| | Min. | Max. |
| L3 | 4.9 | 5.3 |
| L4 | 5.3 | 5.7 |
| L5 | 5.7 | 6.1 |
| L6 | 6.1 | 6.5 |
| L7 | 6.5 | 7.0 |
| L8 | 7.0 | 7.5 |
| L9 | 7.5 | 8.0 |

Tolerance on each Luminous Intensity bin and Luminous Flux are +/- 10%

**SMD Lamp
LTW-M140ZVS**

| Color Ranks Table | | | | | |
|-------------------|---|--------|--------|--------|--------|
| Ranks | Color bin limits at $I_F = 20\text{mA}$ | | | | |
| | CIE 1931 Chromaticity coordinates | | | | |
| A | x | 0.2658 | 0.2768 | 0.2930 | 0.2820 |
| | y | 0.2458 | 0.2394 | 0.2676 | 0.2742 |
| B | x | 0.2739 | 0.2849 | 0.2930 | 0.2820 |
| | y | 0.2600 | 0.2535 | 0.2676 | 0.2742 |
| C | x | 0.2820 | 0.2930 | 0.3010 | 0.2900 |
| | y | 0.2742 | 0.2676 | 0.2816 | 0.2882 |
| D | x | 0.2900 | 0.3010 | 0.3090 | 0.2980 |
| | y | 0.2882 | 0.2816 | 0.2956 | 0.3022 |
| E | x | 0.2980 | 0.3090 | 0.3170 | 0.3060 |
| | y | 0.3022 | 0.2956 | 0.3092 | 0.3162 |
| F | x | 0.3060 | 0.3170 | 0.3250 | 0.3140 |
| | y | 0.3162 | 0.3092 | 0.3232 | 0.3302 |

Tolerance on each Hue (x, y) bin is +/- 0.01

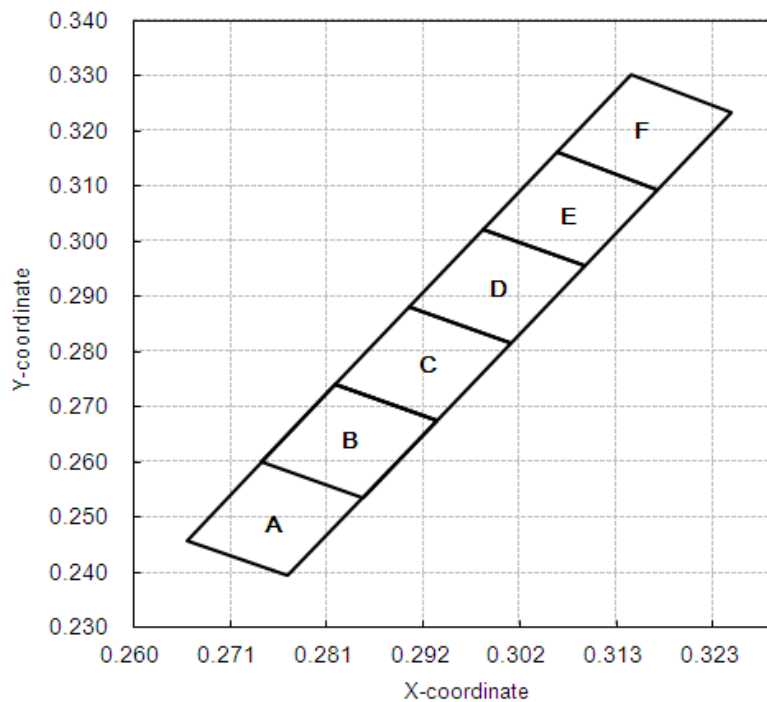

SMD Lamp LTW-M140ZVS

Typical Electrical / Optical Characteristics Curves (25°C Ambient Temperature Unless Otherwise Noted)

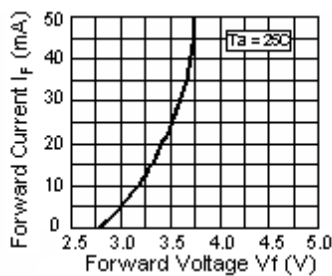
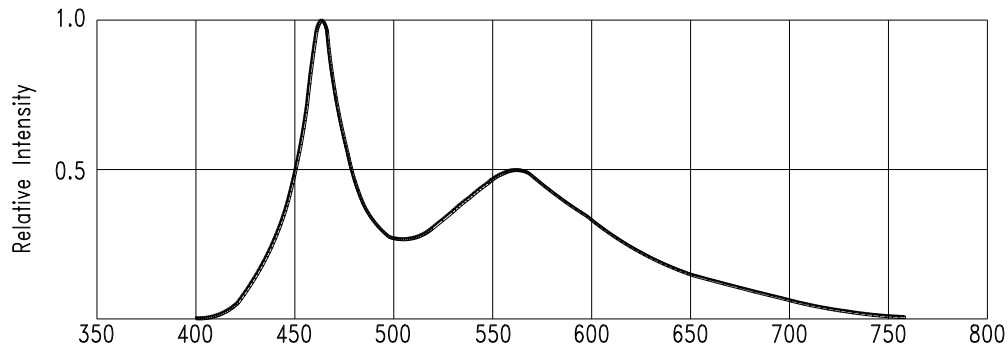

Fig.2 Forward Current vs. Forward Voltage

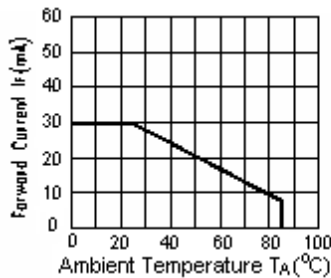

Fig.3 Forward Current Derating Curve

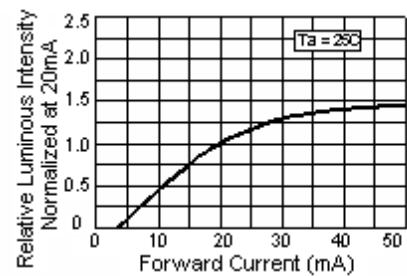

Fig.4 Relative Luminous Intensity vs. Forward Current

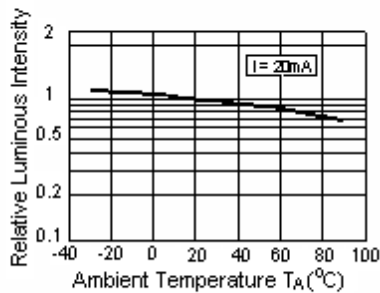

Fig.5 Luminous Intensity vs. Ambient Temperature

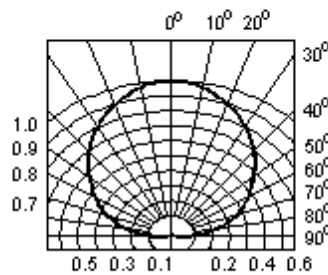

Fig.6 Spatial Distribution

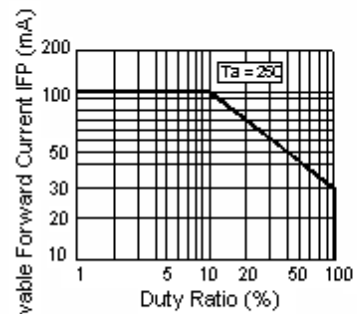

Fig.7 Duty Ratio vs. Allowable Forward Current

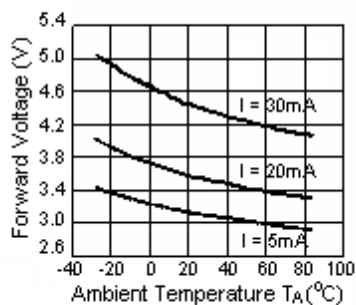

Fig.8 Ambient Temperature vs. Forward Voltage

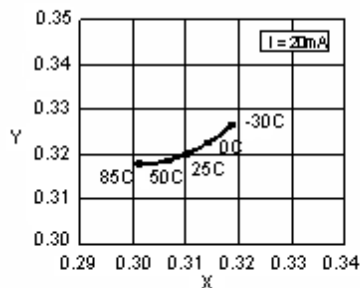

Fig.9 Ambient Temperature vs. Chromaticity Coordinate

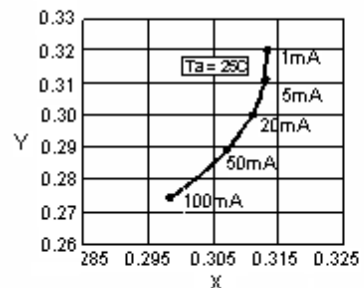

Fig.10 Forward Current vs. Chromaticity Coordinate

SMD Lamp LTW-M140ZVS

User Guide

Cleaning

Do not use unspecified chemical liquid to clean LED they could harm the package.

If cleaning is necessary, immerse the LED in ethyl alcohol or isopropyl alcohol at normal temperature for less than one minute.

Recommend Printed Circuit Board Attachment Pad

Infrared / vapor phase

Reflow Soldering

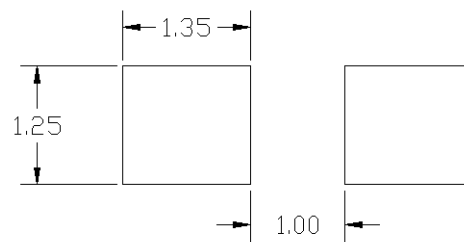

Package Dimensions of Tape

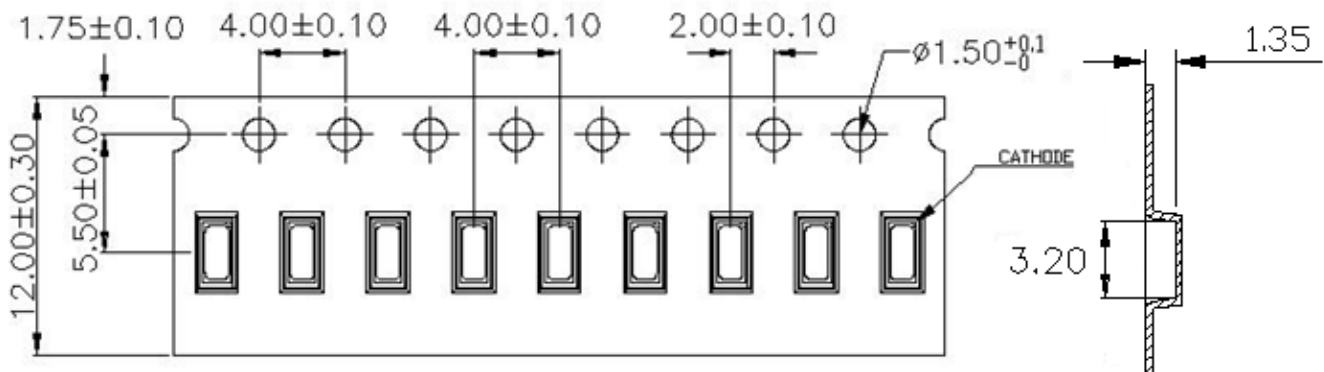

Note: All dimensions are in mm.

**SMD Lamp
LTW-M140ZVS**

Package Dimensions of Reel

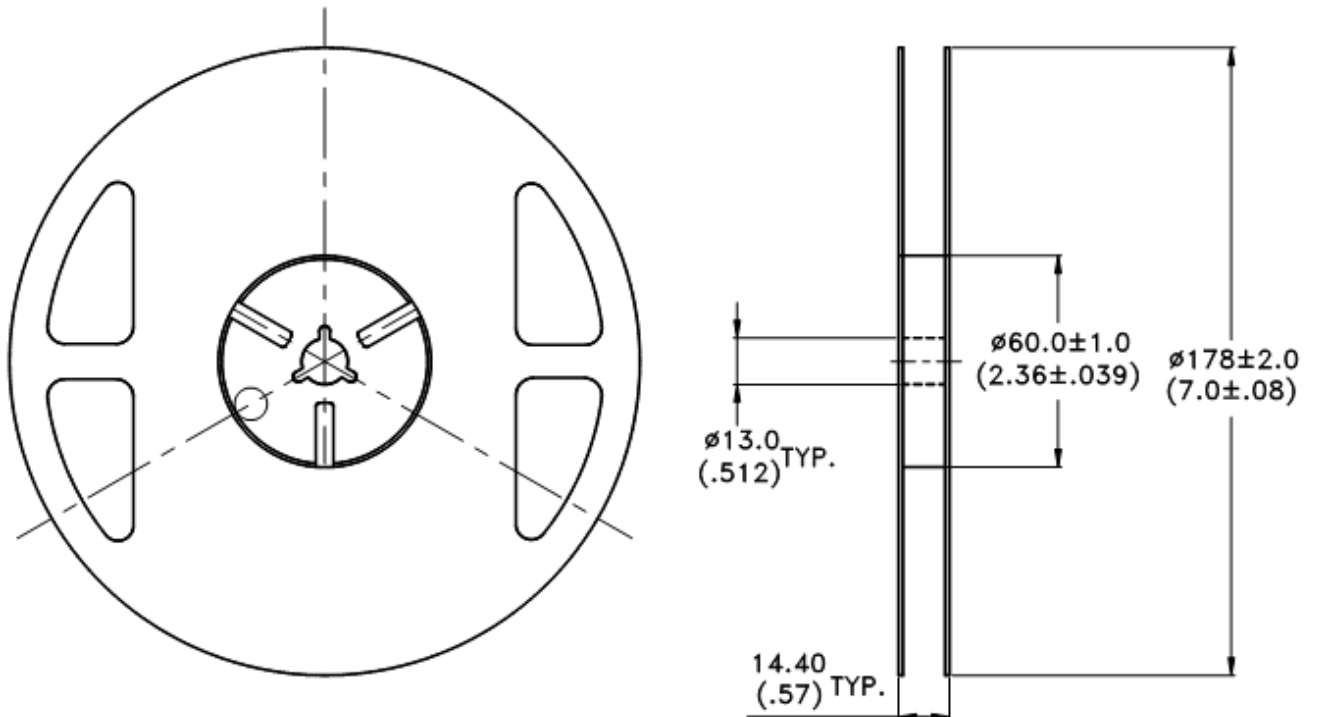

Notes:

1. Empty component pockets sealed with top cover tape.
2. 7 inch reel-2000 pieces per reel.
3. The maximum number of consecutive missing lamps is two.
4. In accordance with EIA-481-1-B specifications.

SMD Lamp LTW-M140ZVS

CAUTIONS

1. Application

The LEDs described here are intended to be used for ordinary electronic equipment (such as office equipment, communication equipment and household applications). Consult Liteon's Sales in advance for information on applications in which exceptional reliability is required, particularly when the failure or malfunction of the LEDs may directly jeopardize life or health (such as in aviation, transportation, traffic control equipment, medical and life support systems and safety devices).

2. Storage

This product is qualified as Moisture sensitive Level 3 per JEDEC J-STD-020 Precaution when handling this moisture sensitive product is important to ensure the reliability of the product.

The package is sealed:

The LEDs should be stored at 30°C or less and 90%RH or less. And the LEDs are limited to use within one year, while the LEDs is packed in moisture-proof package with the desiccants inside.

The package is opened:

The LEDs should be stored at 30°C or less and 60%RH or less. Moreover, the LEDs are limited to solder process within 168hrs. If the Humidity Indicator shows the pink color in 10% even higher or exceed the storage limiting time since opened, that we recommended to baking LEDs at 60°C at least 48hrs. To seal the remainder LEDs return to package, it's recommended to be with workable desiccants in original package.

3. Cleaning

Use alcohol-based cleaning solvents such as isopropyl alcohol to clean the LED if necessary.

4. Soldering

Recommended soldering conditions:

| Reflow soldering | | Wave Soldering | | Soldering iron | |
|------------------|---------------|----------------|--------------|----------------|-----------------|
| Pre-heat | 120~150°C | Pre-heat | 100°C Max. | Temperature | 300°C Max. |
| Pre-heat time | 120 sec. Max. | Pre-heat time | 60 sec. Max. | Soldering time | 3 sec. Max. |
| Soldering Temp. | 260°C Max. | Solder wave | 260°C Max. | | (one time only) |
| Soldering time | 30 sec. Max. | Soldering time | 10 sec. Max. | | |

SMD Lamp LTW-M140ZVS

5. Drive Method

An LED is a current-operated device. In order to ensure intensity uniformity on multiple LEDs connected in parallel in an application, it is recommended that a current limiting resistor be incorporated in the drive circuit, in series with each LED as shown in Circuit A below.

Circuit model A

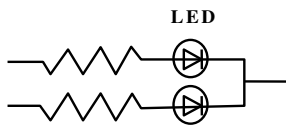

(A) Recommended circuit.

Circuit model B

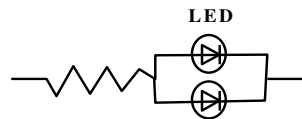

(B) The brightness of each LED might appear different due to the differences in the I-V characteristics of those LEDs.

6. ESD (Electrostatic Discharge)

Static Electricity or power surge will damage the LED.

Suggestions to prevent ESD damage:

- Use of a conductive wrist band or anti-Static glove when handling these LEDs.
- Work tables, storage racks, etc. should be properly grounded.
- Use ion blower to neutralize the static charge which might have built up on surface of the LED's plastic lens as a result of friction between LEDs during storage and handling.

ESD-damaged LEDs will exhibit abnormal characteristics such as high reverse leakage current, low forward voltage, or "no lightup" at low currents.

To verify for ESD damage, check for "light up" and V_f of the suspect LEDs at low currents.

The V_f of "good" LEDs should be $>2.0V@0.1mA$ for InGaN product and $>1.4V@0.1mA$ for AlInGaP product.

**SMD Lamp
LTW-M140ZVS**

7.1 Reliability Test

| Test Item | Test Condition | Reference Standard | Note | Number of Damaged |
|---|--|--------------------------|--------------------|-------------------|
| Resistance to Soldering Heat (Reflow Soldering) | Tsld=260°C, 10sec. (Pre treatment 30°C,60%,168hrs.) | JEITA ED-4701 300 301 | 2 times | 0/30 |
| Solderability (Reflow Soldering) | Tsld=245±5°C, 3sec. (Lead Free Solder) | JEITA ED-4701 300 303 | 1 time Over 95% | 0/30 |
| Thermal Shock | -30°C ~ 85°C 30min.. 30min. | JEITA ED-4701 300 307 | 200 cycles | 0/30 |
| Temperature Cycle | -40°C ~ 25°C ~ 100°C ~ 25°C 30min. 5min. 30min. 5min. | JEITA ED-4701 100 105 | 100 cycles | 0/30 |
| High Temperature Storage | Ta=100°C | JEITA ED-4701 200 201 | 1000 hrs. | 0/30 |
| Temperature Humidity Storage | Ta=60°C, RH=90% | JEITA ED-4701 100 103 | 1000 hrs. | 0/30 |
| Low Temperature Storage | Ta=-40°C | JEITA ED-4701 200 202 | 1000 hrs. | 0/30 |
| Steady State Operating Life Condition 1 | Ta=25°C, IF=20mA | | 1000 hrs. | 0/30 |
| Steady State Operating Life Condition 2 | Ta=25°C, IF=30mA | | 1000 hrs. | 0/30 |
| Steady State Operating Life of High Temperature | Ta=85°C, IF=20mA | | 1000 hrs. | 0/30 |
| Steady State Operating Life of High Humidity Heat | 60°C, RH=90% , IF=20mA | | 1000 hrs. | 0/30 |
| Steady State Operating Life of low Temperature | Ta=-30°C, IF=20mA | | 1000 hrs. | 0/30 |

SMD Lamp LTW-M140ZVS

8. Others

The appearance and specifications of the product may be modified for improvement without prior notice.

9. Suggested Checking List

Training and Certification

1. Everyone working in a static-safe area is ESD-certified?
2. Training records kept and re-certification dates monitored?

Static-Safe Workstation & Work Areas

1. Static-safe workstation or work-Sreas have ESD signs?
2. All surfaces and objects at all static-safe workstation and within 1 ft measure less than 100V?
3. All ionizer activated, positioned towards the units?
4. Each work surface mats grounding is good?

Personnel Grounding

1. Every person (including visitors) handling ESD sensitive (ESDS) items wear wrist strap, heel strap or conductive shoes with conductive flooring?
2. If conductive footwear used, conductive flooring also present where operator stand or walk?
3. Garments, hairs or anything closer than 1 ft to ESD items measure less than 100V*?
4. Every wrist strap or heel strap/conductive shoes checked daily and result recorded for all DLs?
5. All wrist strap or heel strap checkers calibration up to date?

Note: *50V for Blue LED.

Device Handling

1. Every ESDS items identified by EIA-471 labels on item or packaging?
2. All ESDS items completely inside properly closed static-shielding containers when not at static-safe workstation?
3. No static charge generators (e.g. plastics) inside shielding containers with ESDS items?
4. All flexible conductive and dissipative package materials inspected before reuse or recycle?

Others

1. Audit result reported to entity ESD control coordinator?
2. Corrective action from previous audits completed?
3. Are audit records complete and on file?