



Chipsmall Limited consists of a professional team with an average of over 10 year of expertise in the distribution of electronic components. Based in Hongkong, we have already established firm and mutual-benefit business relationships with customers from,Europe,America and south Asia,supplying obsolete and hard-to-find components to meet their specific needs.

With the principle of “Quality Parts,Customers Priority,Honest Operation,and Considerate Service”,our business mainly focus on the distribution of electronic components. Line cards we deal with include Microchip,ALPS,ROHM,Xilinx,Pulse,ON,Everlight and Freescale. Main products comprise IC,Modules,Potentiometer,IC Socket,Relay,Connector.Our parts cover such applications as commercial,industrial, and automotives areas.

We are looking forward to setting up business relationship with you and hope to provide you with the best service and solution. Let us make a better world for our industry!



Contact us

Tel: +86-755-8981 8866 Fax: +86-755-8427 6832

Email & Skype: info@chipsmall.com Web: www.chipsmall.com

Address: A1208, Overseas Decoration Building, #122 Zhenhua RD., Futian, Shenzhen, China





LV49821VH

Bi-CMOS IC

For Portable Electronic Device Use 1.4W × 2ch BTL Power Amplifier

ON Semiconductor®

<http://onsemi.com>

Overview

The LV49821VH incorporates a 2-channel power circuit amplifier capable of low-voltage operation (2.7V and up). It has a function for switching the headphone driver and also has a standby function to reduce the current drain. It is a power amplifier IC optimal for driving the speakers used in portable equipment and low power output equipment.

Use

- Portable DVD-player, Note PC, Portable TV, LCD monitor, Active speaker, and more.

Features

- 2-channels BTL power amplifier built-in: Standard output power = 1.4W ($V_{CC} = 5V$, $R_L = 8\Omega$, THD = 10%)
Output coupling capacitor is unnecessary because of differential output type.
- Standby function built-in: Standard standby current = 0.01 μ A ($V_{CC} = 5V$)
- Second amplifier stop control function built-in: Headphone driver switch (for BTL/SE switch)
Audio mute (Only BTL power amplifier path)
- Supports beep signal input
- Thermal protection circuit built-in
- Operation at low voltage possible: $V_{CC} = 2.7V$ to 5.5V
- Gain setting possible: BTL voltage gain = 0 to 26dB

Specifications

Maximum Ratings at $T_a = 25^\circ\text{C}$

Parameter	Symbol	Conditions	Ratings	Unit
Maximum supply voltage	$V_{CC\ max}$		6	V
Allowable power dissipation	$P_{d\ max}$	Mounted on a specified board.*	1.5	W
Maximum junction temperature	$T_{j\ max}$		150	$^\circ\text{C}$
Operating temperature	T_{opr}		-30 to +75	$^\circ\text{C}$
Storage temperature	T_{stg}		-40 to +150	$^\circ\text{C}$

* Specified board (Our company Evaluation board): 70mm × 70mm × 1.6mm, glass epoxy both side.

Stresses exceeding Maximum Ratings may damage the device. Maximum Ratings are stress ratings only. Functional operation above the Recommended Operating Conditions is not implied. Extended exposure to stresses above the Recommended Operating Conditions may affect device reliability.

LV49821VH

Operating Conditions at $T_a = 25^\circ\text{C}$

Parameter	Symbol	Conditions	Ratings	Unit
Recommended supply voltage	V_{CC}		5	V
Recommended load resistance	R_L		4 to 32	Ω
Operation supply voltage range	V_{CC} op1	$R_L = 8\Omega$ or more	2.7 to 5.5	V
	V_{CC} op2	$R_L = 4\Omega$ or 6Ω	2.7 to 3.7	V

Note : Please determine supply voltage used with due consideration of allowable power dissipation.

Electrical Characteristics at $T_a = 25^\circ\text{C}$, $V_{CC} = 5\text{V}$, $f_{in} = 1\text{kHz}$, $R_L = 8\Omega$, $V_2 = \text{high}$, $V_6 = \text{Low}$

Parameter	Symbol	Conditions	Ratings			Unit
			min	typ	max	
Quiescent current	I_{CCOP1}	No signal, $R_L = \infty$		7.1	13	mA
	I_{CCOP2}	No signal, $R_L = \infty$, $V_6 = \text{High}$ (2nd amplifier stop)		4.0		mA
Standby current	I_{STBY}	No signal, $R_L = \infty$, $V_2 = \text{Low}$ (Standby mode)		0.01	10	μA
Maximum output power	P_O max	THD = 10%	0.91	1.4		W
Voltage gain	V_G	$V_{in} = -25\text{dBV}$	17.6	19.1	20.6	dB
Voltage gain difference	V_{GR}		0		26	dB
Channel balance	CHB	$V_{in} = -25\text{dBV}$	-1.5	0	+1.5	dB
Total harmonic distortion	THD	$V_{in} = -25\text{dBV}$		0.3	1	%
Output noise voltage	V_{NO}	$R_g = 620\Omega$, 20 to 20kHz		35	100	μV_{rms}
Channel separation	CHsep	$V_{out} = -25\text{dBV}$, 20 to 20kHz	50	60		dB
Output offset voltage	V_{DCOS}	$R_g = 620\Omega$	-30		+30	mV
Muting attenuation level	MUTE1	$V_{in} = 0\text{dBV}$, $V_2 = \text{Low}$ (Standby mode)		-110		dBV
	MUTE2	$V_{in} = -10\text{dBV}$, $V_6 = \text{High}$ (2nd amplifier stop)		-85		dBV
Ripple rejection ratio	SVRR	$R_g = 620\Omega$, $f_r = 100\text{Hz}$, $V_r = -20\text{dBV}$		35		dB
Reference Voltage (pin 4)	V_{ref}			2.5		V
High level control voltage (pin 2)	V_{STBH}	Power amplifier operation mode	1.6		V_{CC}	V
Low level control voltage (pin 2)	V_{STBL}	Power amplifier standby mode	0		0.3	V
High level control voltage (pin 6)	V_{2CNTH}	2nd amplifier standby mode (SE mode)	$4V_{CC}/5$		V_{CC}	V
Low level control voltage (pin 6)	V_{2CNTL}	2nd amplifier operation mode (BTL mode)	0		$V_{CC}/2$	V

Package Dimensions

unit : mm (typ)

3377

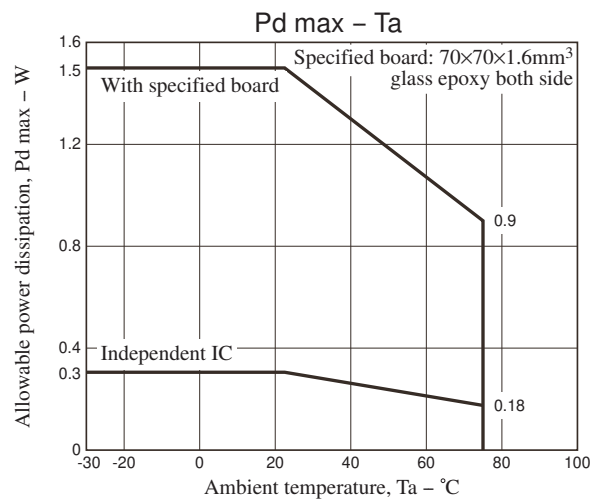
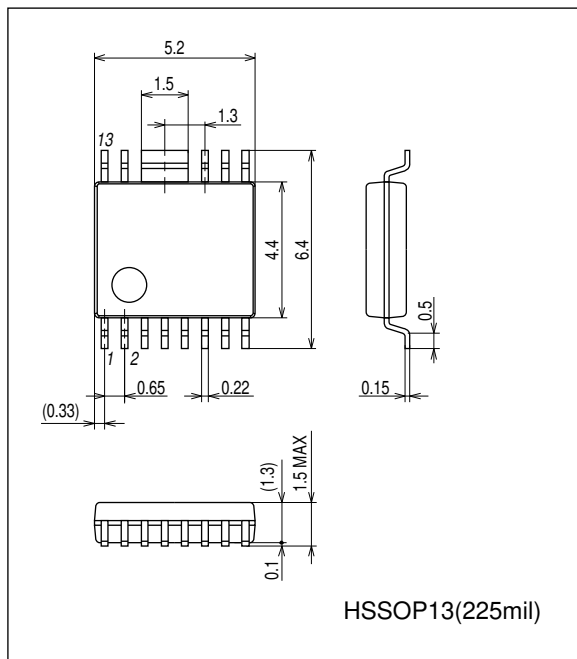

LV49821VH

Block Diagram

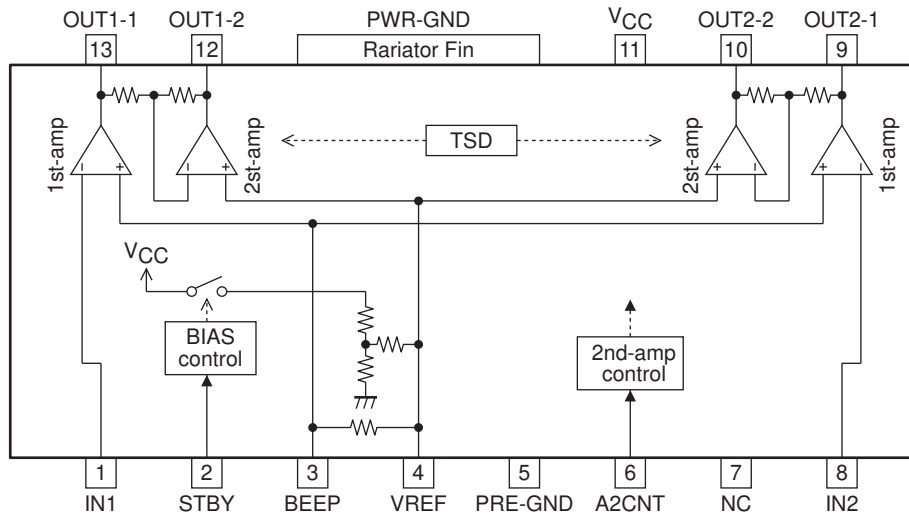

Test Circuit

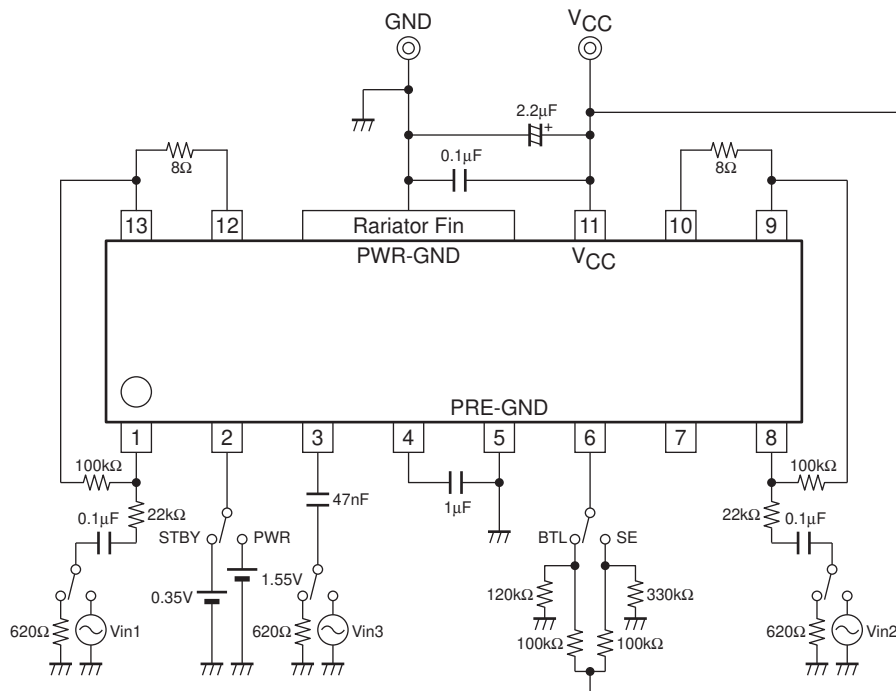

LV49821VH

Evaluation Board Circuit

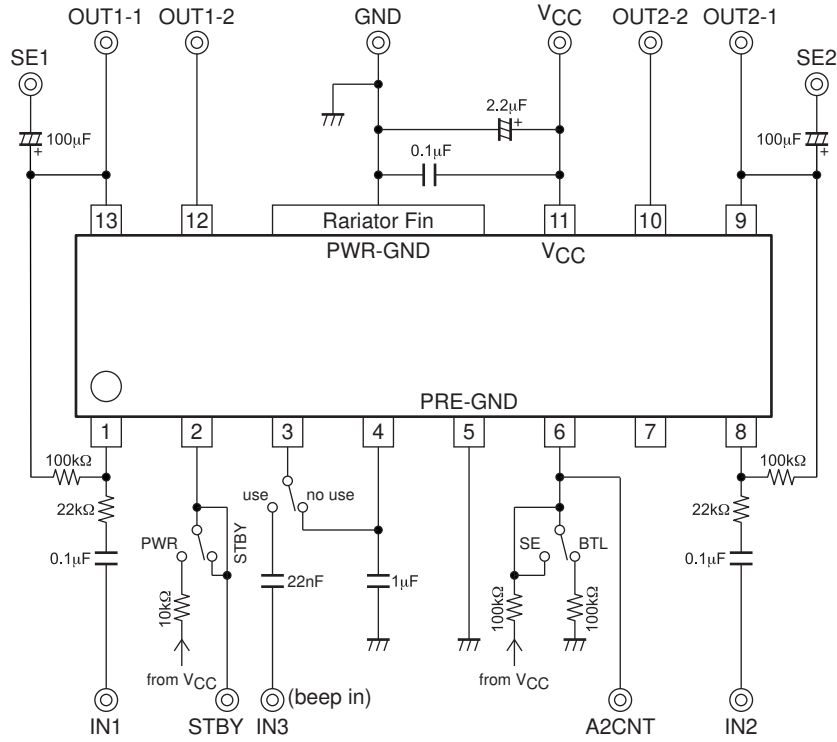

Evaluation Board Layout (70mm × 70mm × 1.6mm)

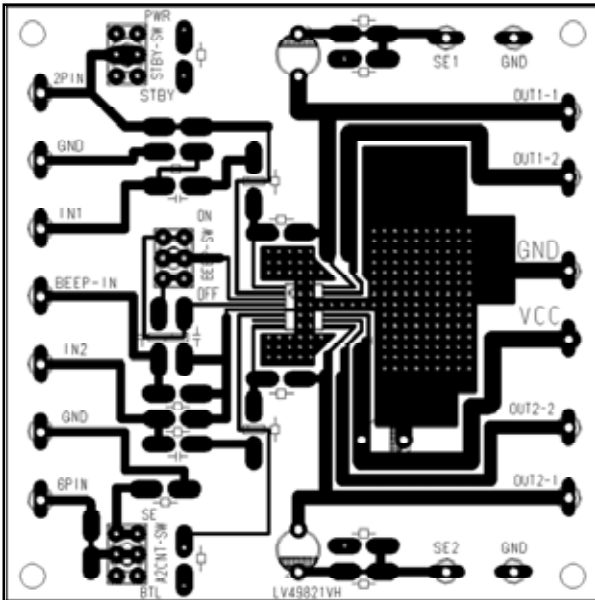

Top layer

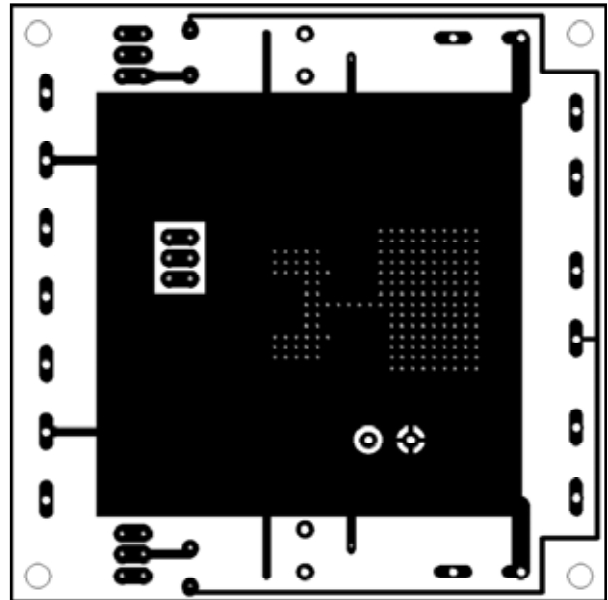

Bottom Layer

LV49821VH

Application Circuit Example 1

(BTL/SE switching function use)

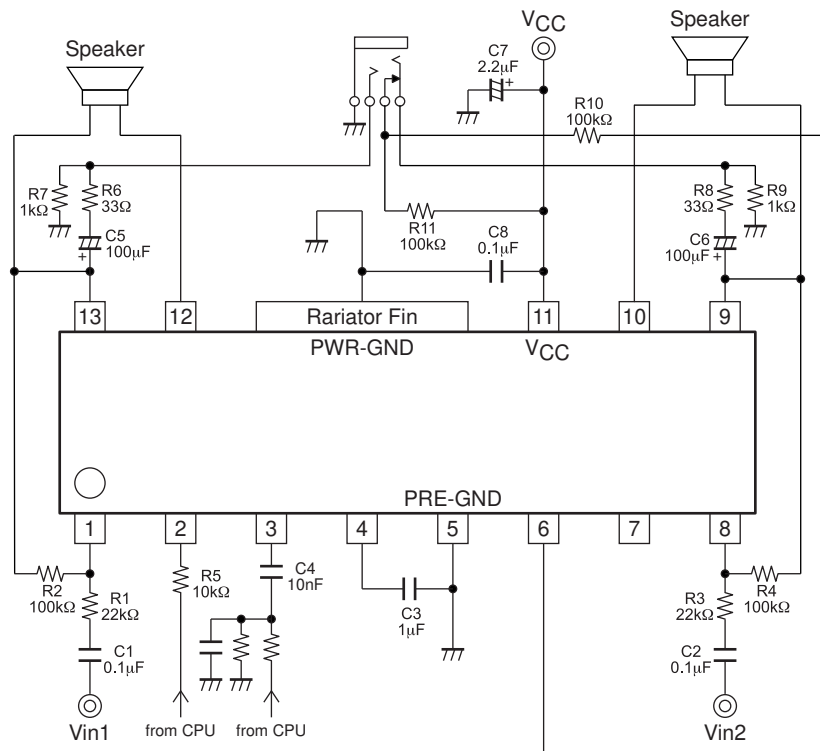

Application Circuit Example 2

(Only BTL function use)

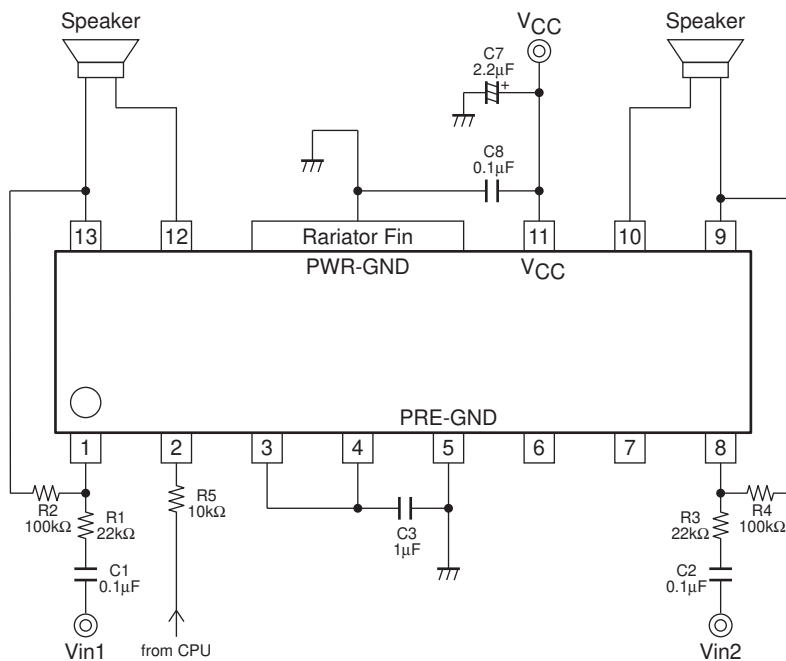

LV49821VH

Pin Function

Pin No.	Pin name	Pin voltage $V_{CC} = 5V$	Function	Equivalent circuit
1 8	IN1 IN2	2.5V 2.5V	Power amplifier input pin (1ch). Power amplifier input pin (2ch).	
2	STBY	External apply	Standby control pin. <ul style="list-style-type: none"> Standby mode (0 to 0.3V) Operation mode (1.6V to V_{CC}) 	
3 4	BEEP VREF	2.5V 2.5V	Beep signal input pin. Reference voltage pin.	
5	PRE-GND	0V	Pre-stage block ground pin	
6	A2CNT	External apply	2nd amplifier stop control pin.	
7	NC	-	Unused pin.	
9 13	OUT2-1 OUT1-1	2.5V 2.5V	BTL 1st output pin (2ch). BTL 1st output pin (1ch).	
10 12	OUT2-2 OUT1-2	2.5V 2.5V	BTL 2nd output pin (2ch). BTL 2nd output pin (1ch).	
11	V_{CC}	External apply	Power supply pin.	
FIN	PWR-GND	0V	Power system ground pin, Radiation fin.	

Usage Note

1. Input coupling capacitor (C1 and C2)

C1 and C2 are input coupling capacitors that are used to cut the DC component. The input coupling capacitors C1, C2 and the input resistors R1 and R3 make up the high-pass filter, attenuating the bass frequency. Therefore, the capacitance value must be selected with due consideration of the cut-off frequency.

The cut-off frequencies are expressed by the following formulas.

$$1\text{ch} \Rightarrow fc1 = 1/(2\pi \times C1 \times R1)$$

$$2\text{ch} \Rightarrow fc2 = 1/(2\pi \times C2 \times R3)$$

This capacitor affects the pop sound at startup. Note with care that increasing the capacitance value lengthens the charging time of the capacitor, which will make the pop sound louder.

2. BTL voltage gain

The voltage gain of the first amplifier is determined by the ratio between the resistors R1 and R2 (R3 and R4).

$$1\text{ch} \Rightarrow Vg1 = 20 \times \log(R2/R1) \dots \text{unit: dB}$$

$$2\text{ch} \Rightarrow Vg2 = 20 \times \log(R4/R3) \dots \text{unit: dB}$$

Therefore, the BTL voltage gain is expressed by the following formulas.

$$1\text{ch} \Rightarrow VgBTL1 = 6 + 20 \times \log(R2/R1) \dots \text{unit: dB}$$

$$2\text{ch} \Rightarrow VgBTL2 = 6 + 20 \times \log(R4/R3) \dots \text{unit: dB}$$

The BTL voltage gain must be set in the range of 0 to 26 dB.

3. Beep signal input pin (pin 3)

This pin is connected to the non-inverting input block of the first amplifier of the BTL amplifier, and is biased internally by a 50kΩ resistor. The input coupling capacitor C4 and the bias resistor make up a high-pass filter that attenuates bass band signals, so when determining the C4 capacitance value, the value must be set with due consideration of the cut-off frequency. The cut-off frequency is expressed by the following formula.

$$fc3 = 1/(2\pi \times C4 \times 50000)$$

In addition, when input from Pin 3, the BTL voltage gain is expressed by the following formulas.

$$1\text{ch} \Rightarrow VgBTL1 = 6 + 20 \times \log(1+R2/(R1 + ro)) \dots \text{unit: dB}$$

$$2\text{ch} \Rightarrow VgBTL2 = 6 + 20 \times \log(1+R4/(R3 + ro)) \dots \text{unit: dB}$$

When setting the signal level, the signal should be attenuated and input as shown in Fig.1.

When not using this input pin, connect it to pin 4 as shown in Application Circuit Example-2.

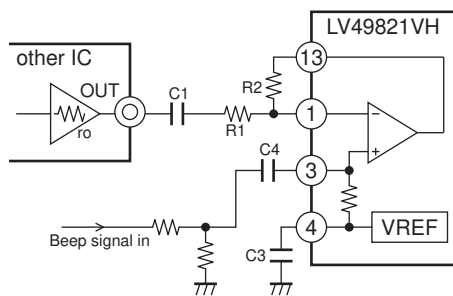

Fig.1

4. pin 4 capacitor (C3)

This capacitor is a ripple filter capacitor. The internal resistors (100kΩ + 450kΩ) and C3 make up a low-pass filter that is used to reduce the power supply ripple component and increase the ripple rejection ratio.

Note that inside the IC, the rising-transient-response-characteristic of the pin 4 voltage (reference voltage) is used to activate the automatic pop sound reduction circuit. Therefore, when reducing the C3 capacitance value to increase the voltage rise speed, the design should take into account that the pop sound increases during voltage rise.

5. Power supply line capacitor (C7 and C8)

The bypass capacitor C8 is used to remove the high frequency component that cannot be eliminated by the power supply capacitor C7 (chemical capacitor). Place the bypass capacitor C8 as near to the IC as possible, and use a ceramic capacitor with good high frequency characteristics.

When using a stabilized power supply, these capacitors can also be combined into a single 2.2μF ceramic capacitor.

Note that when the power supply line is relatively unstable, the power supply capacitor C7 capacitance value must be increased.

6. Standby pin (pin 2)

By controlling the standby pin, the mode changeover can be made between standby and operation modes. Direct control is possible using the CPU output port, but inserting a series resistor R5 (1 kΩ or more) is recommended in case the pin is affected by digital noise from the CPU.

Standby mode ... V2 = 0V to 0.3V

Operating mode... V2 = 1.6V to VCC

In addition, when not using standby mode, this pin can also be used interlocked with the power supply as shown in Fig. 2. The series resistor R5 can be eliminated, but the current I2 expressed by the following formula flows through the standby pin, so this should be taken into account in the design.

$$\text{Pin 2 inflow current (unit: A): } I_2 = 7 \times 10^{-6} + (V_{CC} - 0.7) / (R_5 + 30000)$$

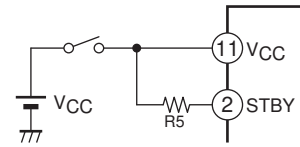

Fig.2

7. Pin 6 control (2nd amplifier stop control function)

Pin 6 performs on/off control for the BTL amplifier's second amplifier operation. This function enables switching between speaker drive (BTL output system) and headphone drive (single end output system). The control comparator is connected to this pin, and this threshold voltage is generated by resistance division from the supply voltage. For this reason, care should be taken, as the threshold value varies according to the supply voltage. When switching using a headphone jack switch, the connection method shown in Application Circuit Example-1 is recommended.

Comparator threshold value: $V_{th} = V_{CC} \times 2/3$

In addition, when controlling this pin with the CPU (BTL amplifier mute function), care should be taken for the relationship between the supply voltage used by the CPU and the supply voltage used by the power amplifier IC. When the supply voltage used by the power amplifier IC is higher, open/low format control as shown in Fig.3 and Fig.4 is recommended. In addition, there is also a control method that uses three resistors as shown in Fig.5. The recommended ratio between the resistance values of these three resistors is as follows.

RC1, RC2, RC3 resistance ratio ... RC1 : RC2 : RC3 = 1 : 1 : 3

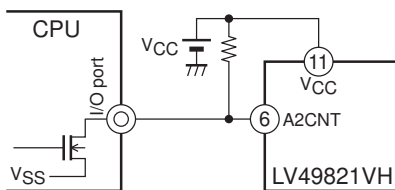

Figure 3

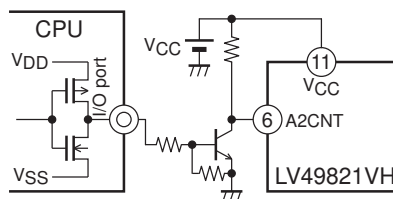

Figure 4

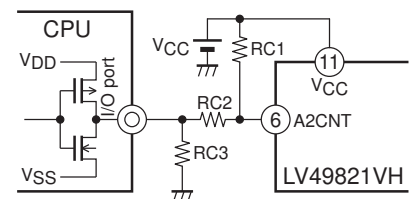

Figure 5

8. Headphone drive

When also using the BTL amplifier's first amplifier as the headphone amplifier, it is recommended to adjust the level by inserting series resistors R6 and R8 to the signal line as shown in Application Circuit Example-1.

Note that this series resistor, the headphone load resistance and the output coupling capacitors C5 and C6 make up a high-pass filter, so this should be taken into account in the design. The cut-off frequencies are expressed by the following formulas.

$$1\text{ch} \Rightarrow fc1 = 1 / (2\pi \times C5 \times (R6 + R_L))$$

$$2\text{ch} \Rightarrow fc2 = 1 / (2\pi \times C6 \times (R8 + R_L))$$

9. Load capacitance

When connecting a capacitor between the output pin and ground to suppress electromagnetic radiation or other purposes, the effects of this capacitor may cause the power amplifier phase margin to be reduced, resulting in oscillation. When adding this capacitor, care should be taken for the capacitance value.

Recommended capacitance value: 0.033μF to 0.33μF

10. Thermal protection circuit

The IC has a built-in thermal protection circuit that can reduce the risk of breakdown or degradation when the IC becomes abnormally hot for some reason. When the internal chip junction temperature Tj rises to approximately 170°C, this protective circuit operates to cut off the power supply to the power amplifier block and stop signal output. Operation recovers automatically when the chip temperature drops to approximately 130°C.

Note that this circuit cannot always prevent breakdown or degradation, so sufficient care should be taken for using the IC. When the chip becomes abnormally hot, immediately turn off the power and determine the cause.

11. Short-circuit between pins

Turning on the power supply with the short-circuit between terminals leads to the deterioration and destruction of IC. When fixing the IC to the substrate, please check that the solder is not short-circuited between the terminals before turning on the power.

12. Load Short-circuit

Leaving the IC in the load short-circuit for many hours leads to the deterioration and destruction of the IC. The load must not be short-circuited absolutely.

13. Maximum rating

When the rated value used is just below to the absolute maximum ratings value, there is a possibility to exceed the maximum rating value with slight extrusion variable. Also, it can be a destructive accident.

Please use within the absolute maximum ratings with sufficient variation margin of supply voltage.

In addition, the package of this IC has low thermal radiation characteristics, so secure sufficient thermal radiation by providing a copper foil land on the printed circuit board near the heat sink.

When $V_{CC} = 5V$ and load = 8Ω , a ground line copper foil area of approximately $50mm \times 50mm$ is recommended.

LV49821VH

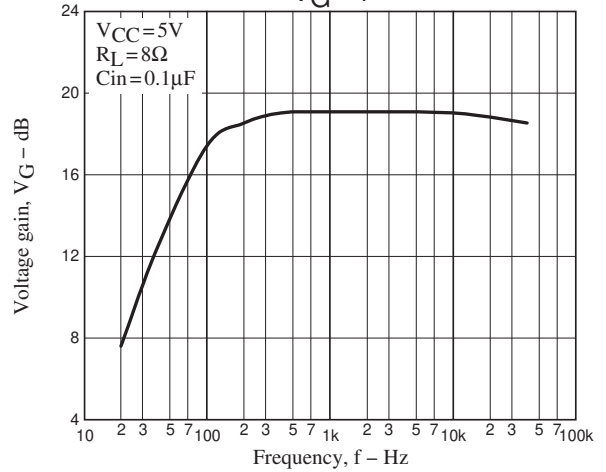
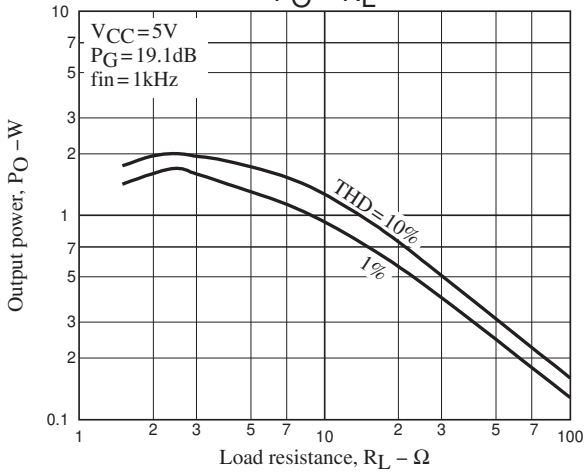
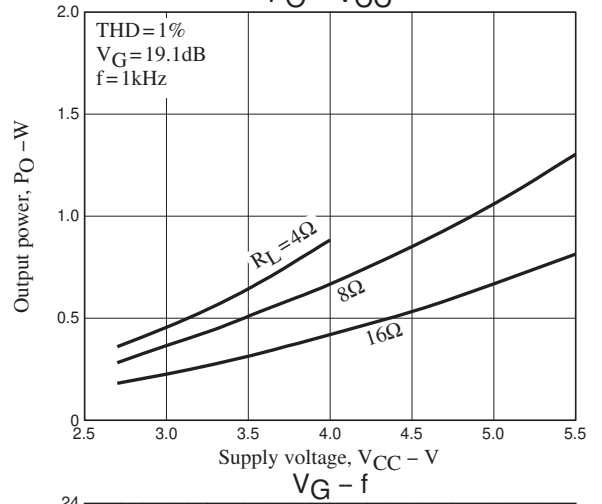
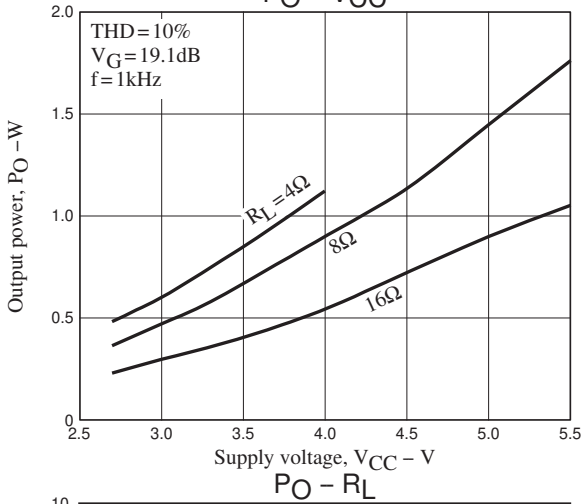
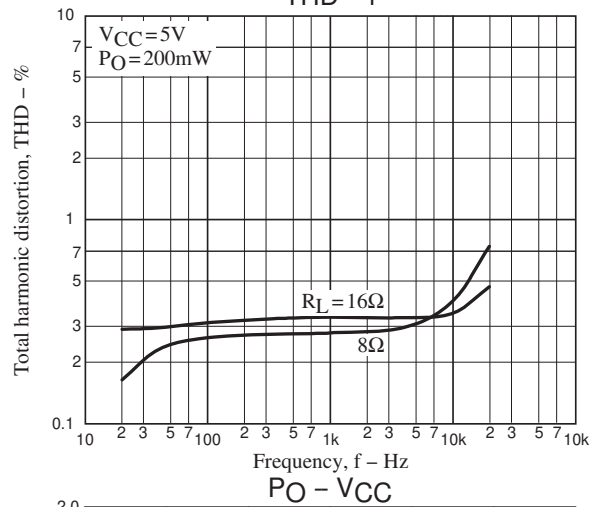
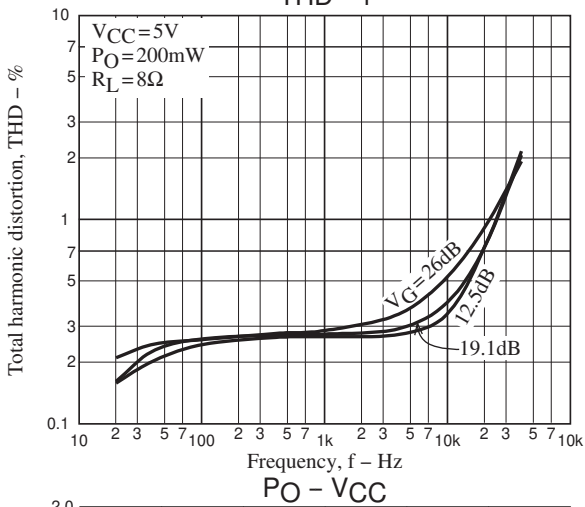
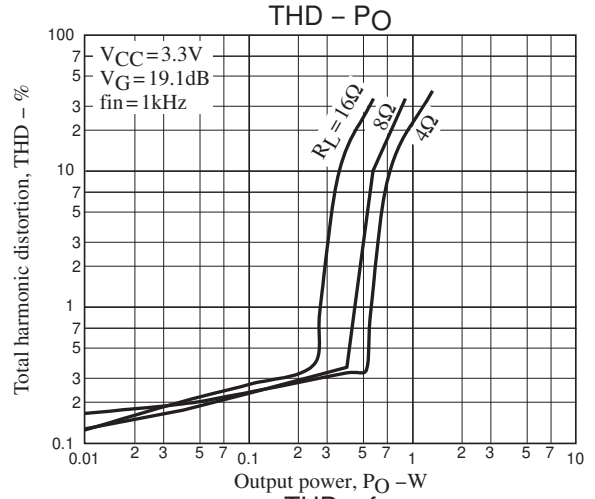
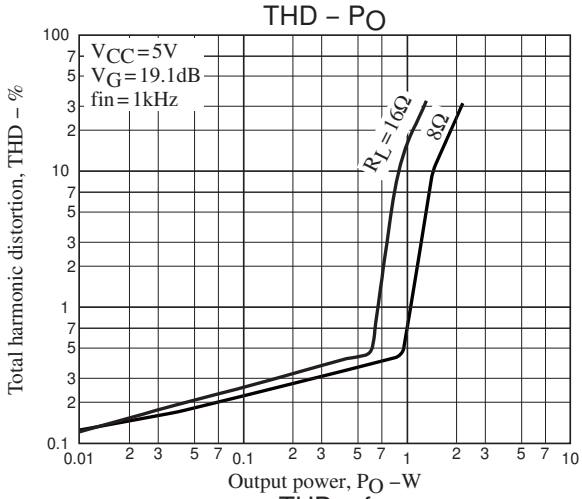

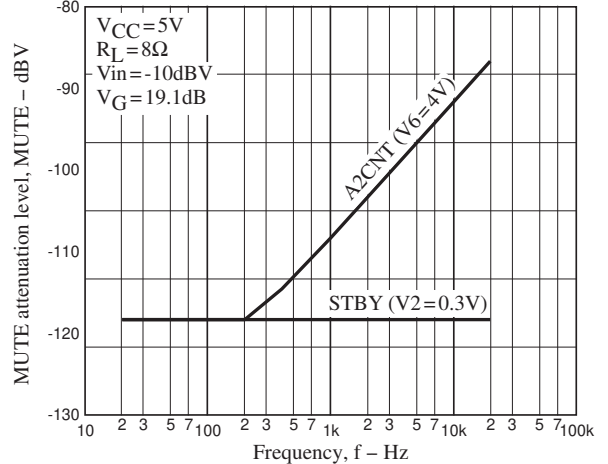
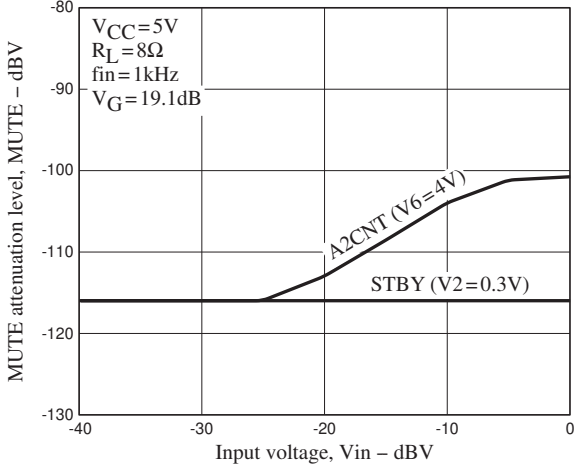
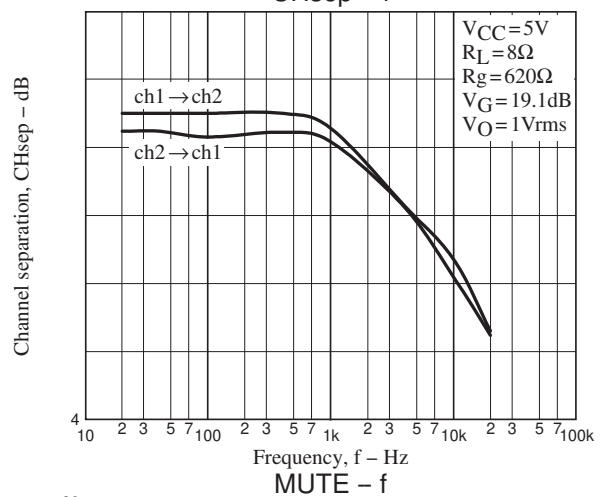
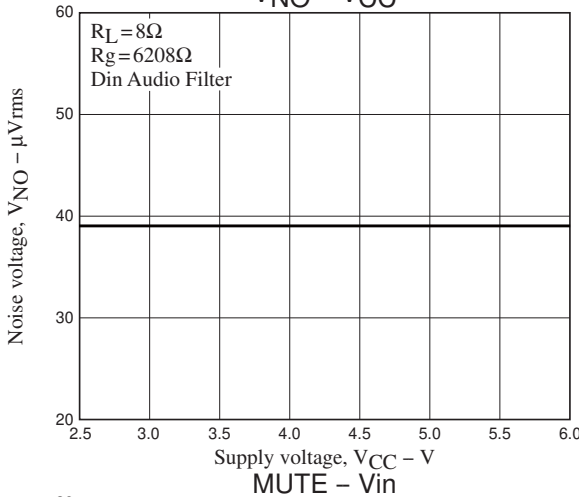
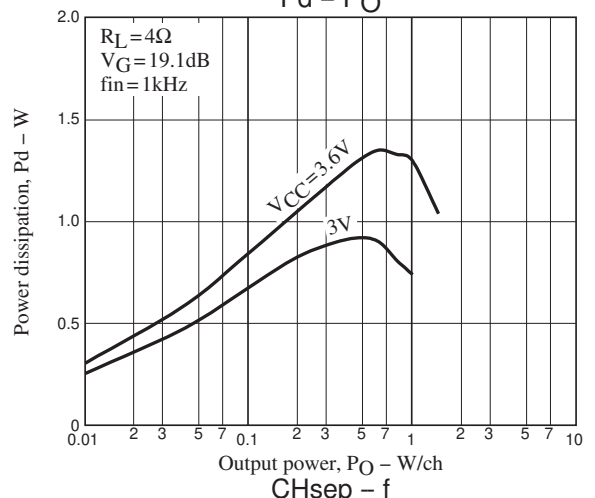
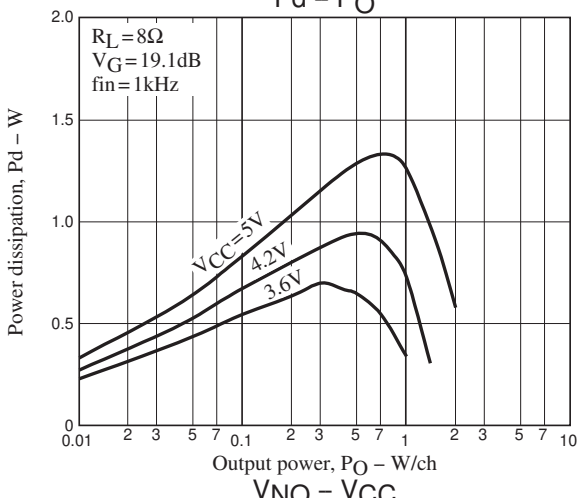
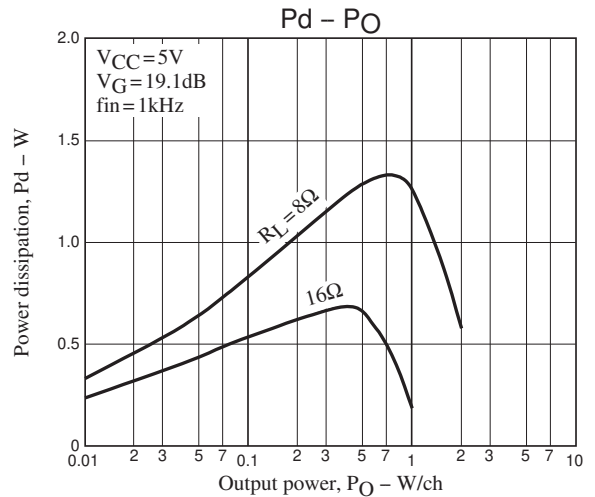
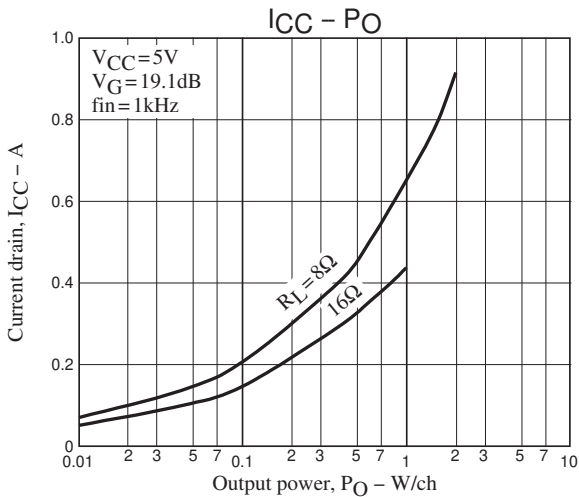

LV49821VH

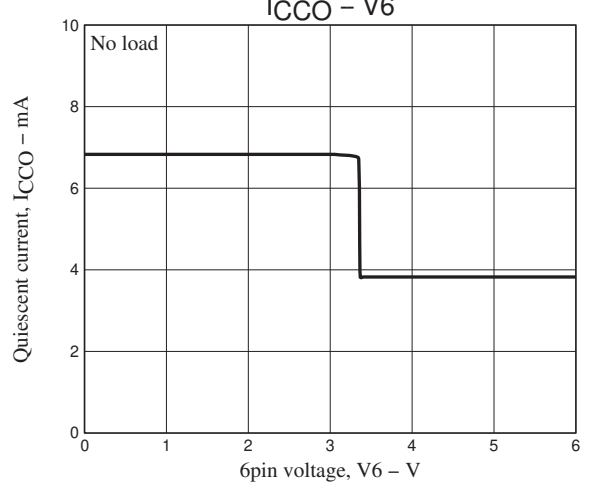
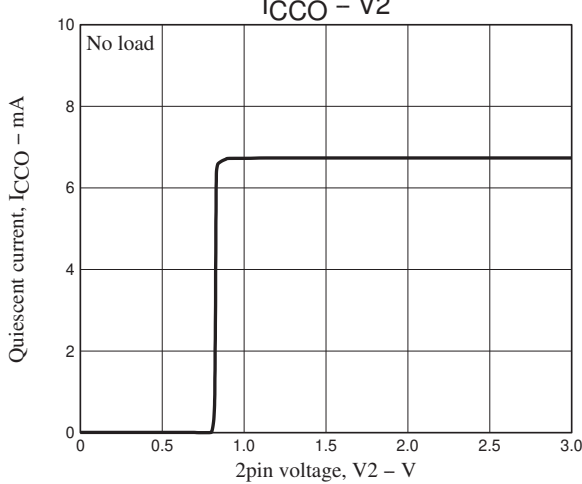
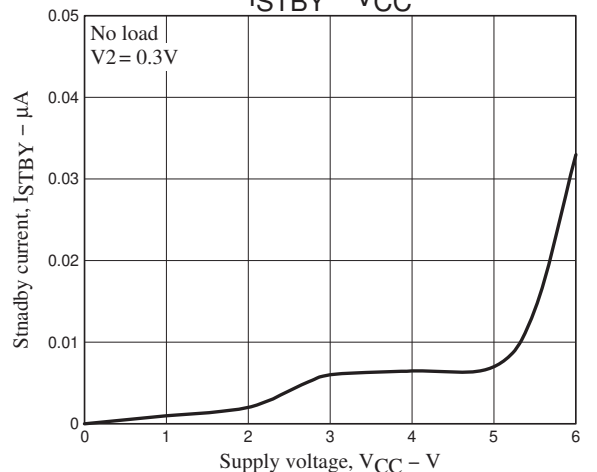
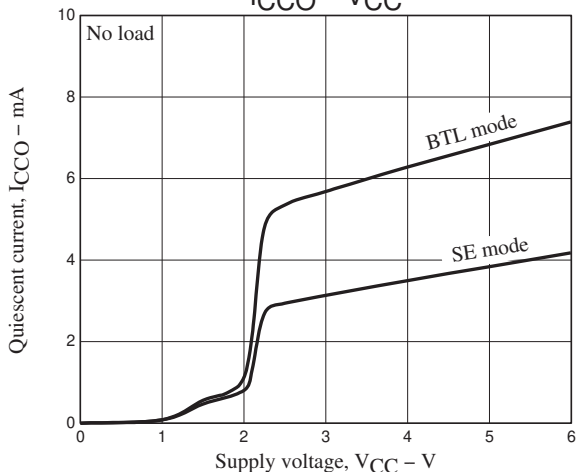
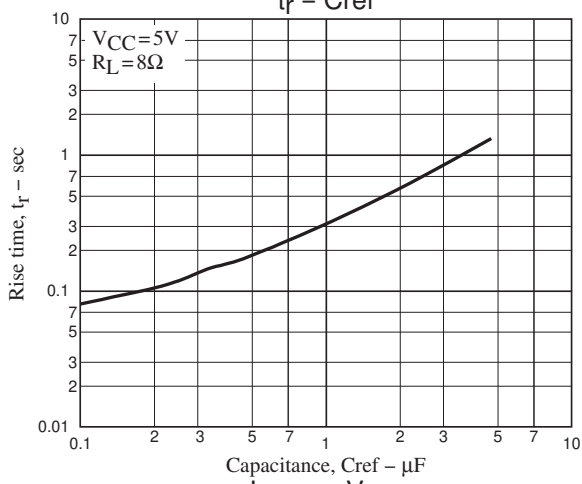
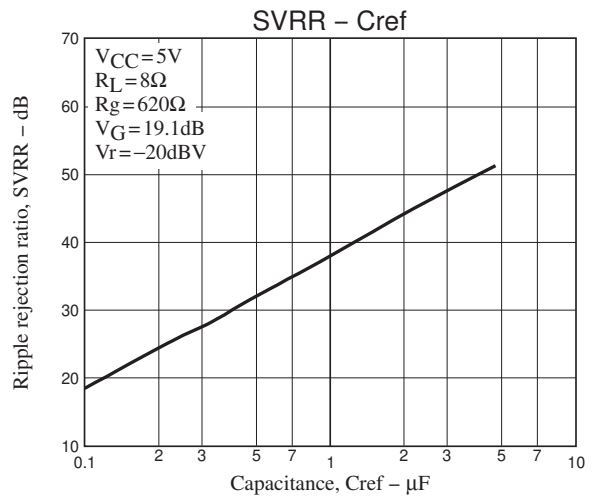
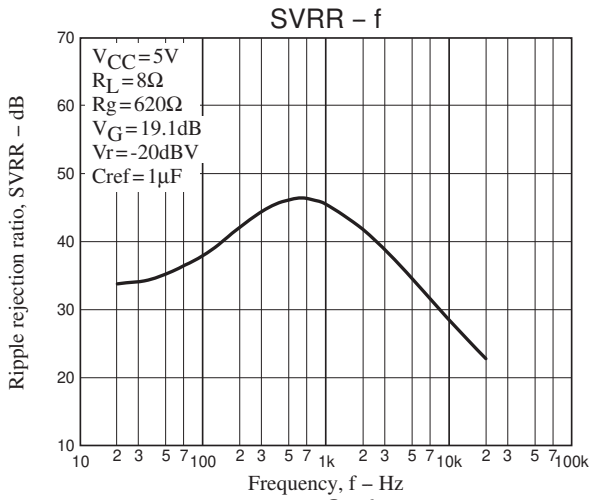

LV49821VH

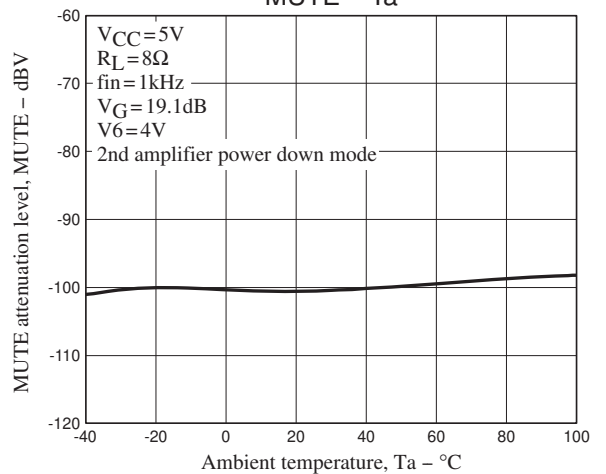
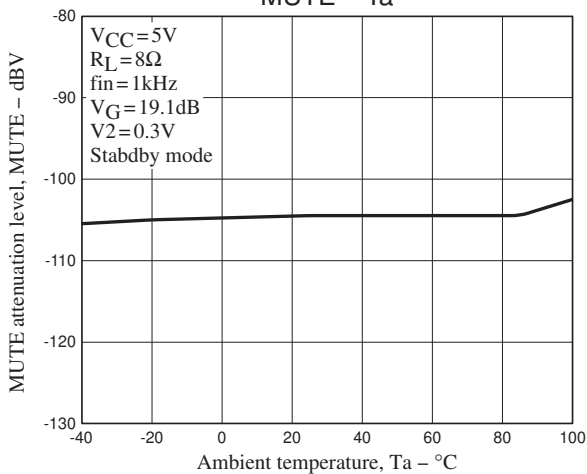
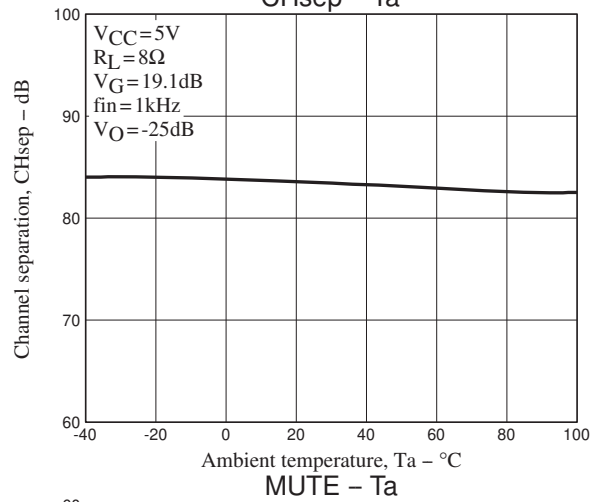
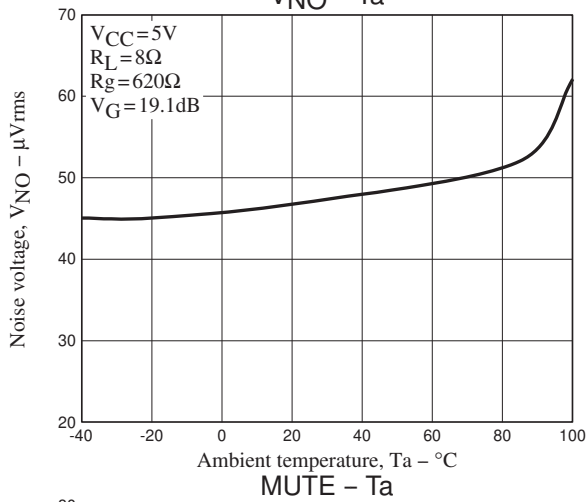
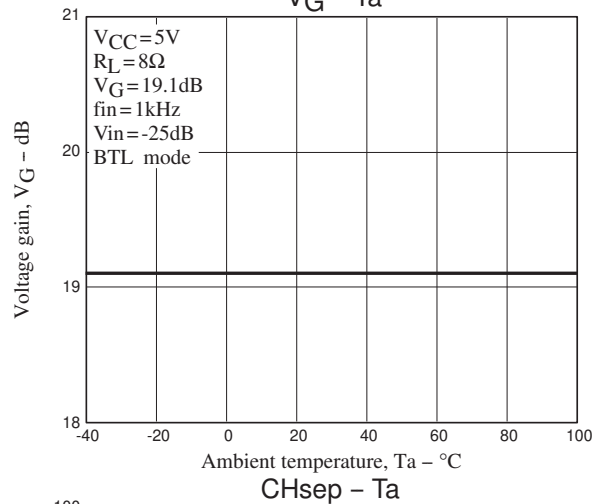
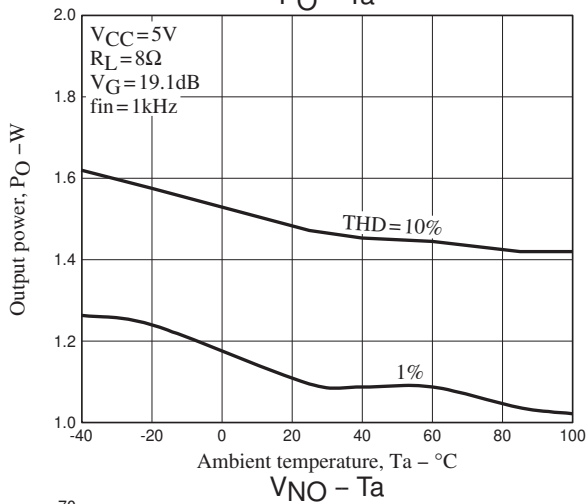
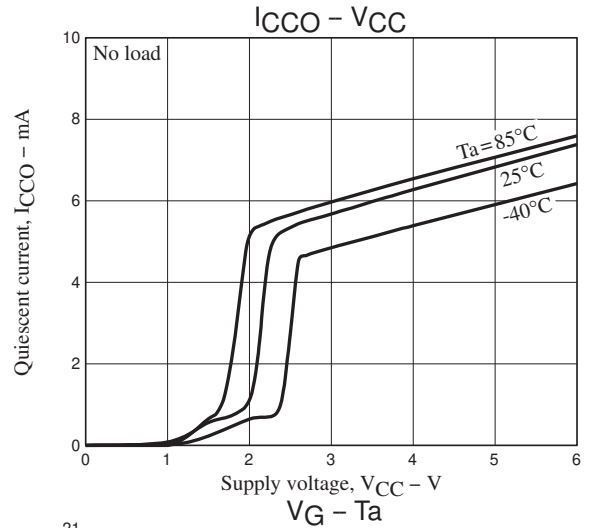
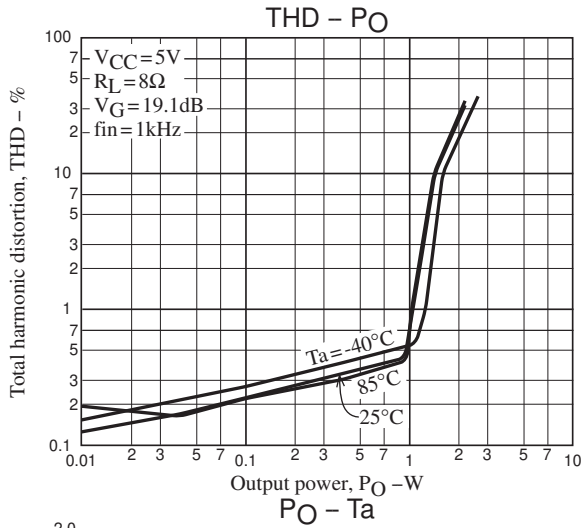

LV49821VH

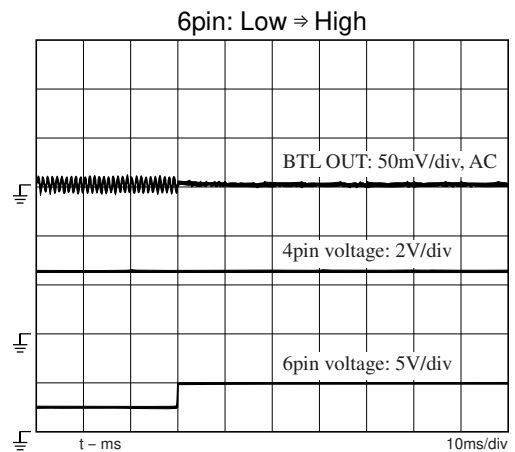
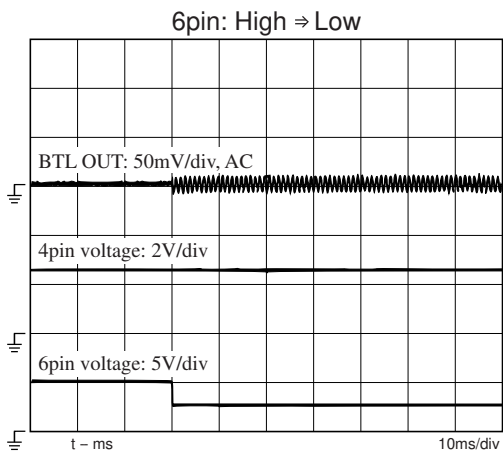
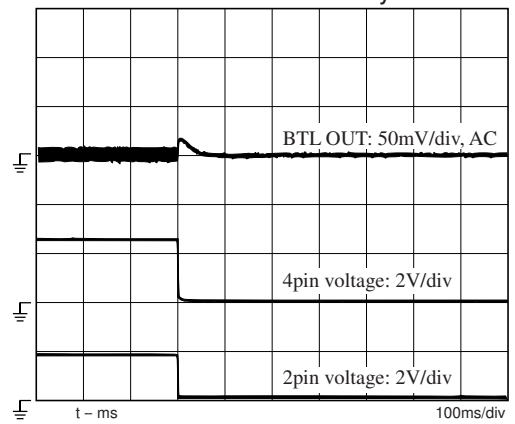
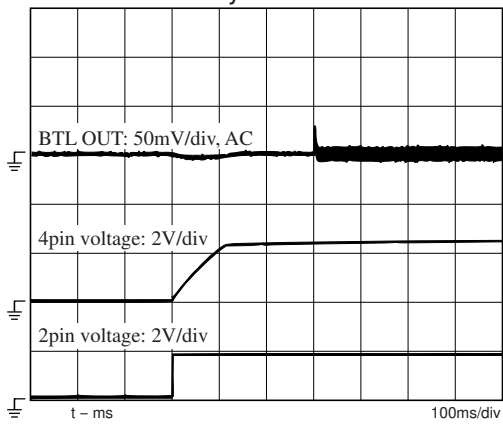
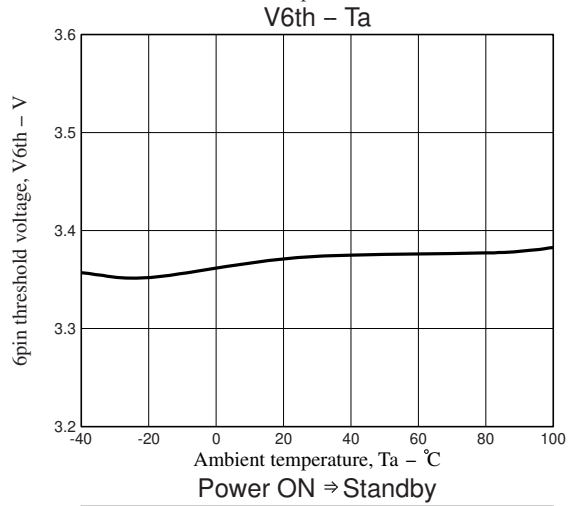
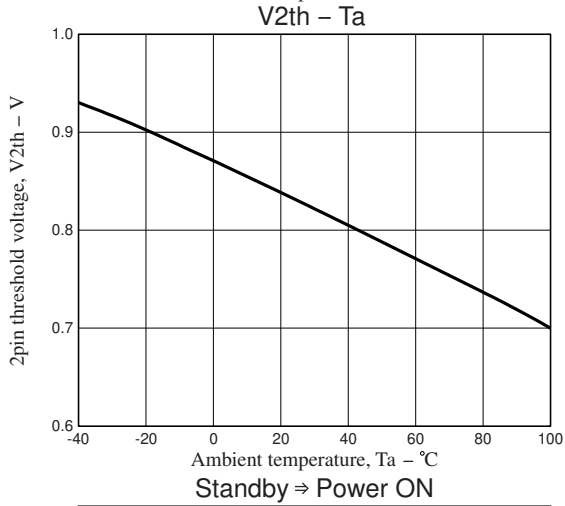
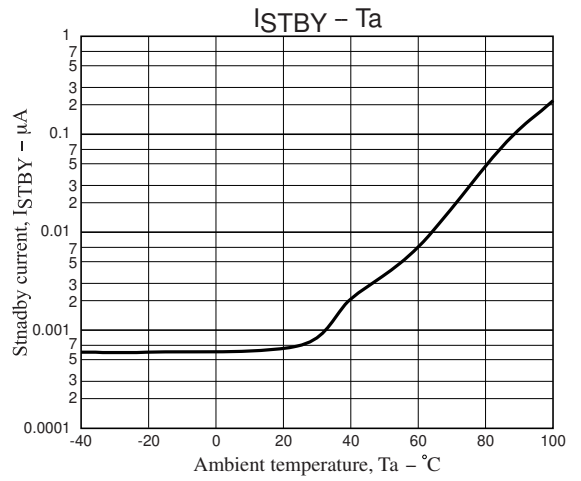
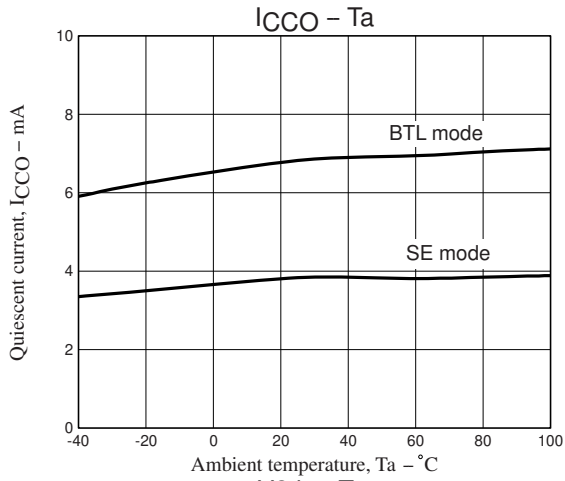

ON Semiconductor and the ON logo are registered trademarks of Semiconductor Components Industries, LLC (SCILLC). SCILLC owns the rights to a number of patents, trademarks, copyrights, trade secrets, and other intellectual property. A listing of SCILLC's product/patent coverage may be accessed at www.onsemi.com/site/pdf/Patent-Marking.pdf. SCILLC reserves the right to make changes without further notice to any products herein. SCILLC makes no warranty, representation or guarantee regarding the suitability of its products for any particular purpose, nor does SCILLC assume any liability arising out of the application or use of any product or circuit, and specifically disclaims any and all liability, including without limitation special, consequential or incidental damages. "Typical" parameters which may be provided in SCILLC data sheets and/or specifications can and do vary in different applications and actual performance may vary over time. All operating parameters, including "Typicals" must be validated for each customer application by customer's technical experts. SCILLC does not convey any license under its patent rights nor the rights of others. SCILLC products are not designed, intended, or authorized for use as components in systems intended for surgical implant into the body, or other applications intended to support or sustain life, or for any other application in which the failure of the SCILLC product could create a situation where personal injury or death may occur. Should Buyer purchase or use SCILLC products for any such unintended or unauthorized application, Buyer shall indemnify and hold SCILLC and its officers, employees, subsidiaries, affiliates, and distributors harmless against all claims, costs, damages, and expenses, and reasonable attorney fees arising out of, directly or indirectly, any claim of personal injury or death associated with such unintended or unauthorized use, even if such claim alleges that SCILLC was negligent regarding the design or manufacture of the part. SCILLC is an Equal Opportunity/Affirmative Action Employer. This literature is subject to all applicable copyright laws and is not for resale in any manner.