



Chipsmall Limited consists of a professional team with an average of over 10 year of expertise in the distribution of electronic components. Based in Hongkong, we have already established firm and mutual-benefit business relationships with customers from,Europe,America and south Asia,supplying obsolete and hard-to-find components to meet their specific needs.

With the principle of “Quality Parts,Customers Priority,Honest Operation,and Considerate Service”,our business mainly focus on the distribution of electronic components. Line cards we deal with include Microchip,ALPS,ROHM,Xilinx,Pulse,ON,Everlight and Freescale. Main products comprise IC,Modules,Potentiometer,IC Socket,Relay,Connector.Our parts cover such applications as commercial,industrial, and automotives areas.

We are looking forward to setting up business relationship with you and hope to provide you with the best service and solution. Let us make a better world for our industry!



Contact us

Tel: +86-755-8981 8866 Fax: +86-755-8427 6832

Email & Skype: info@chipsmall.com Web: www.chipsmall.com

Address: A1208, Overseas Decoration Building, #122 Zhenhua RD., Futian, Shenzhen, China



LV5237JA

Bi-CMOS IC

9-channel LED Driver



ON Semiconductor®

www.onsemi.com

Overview

The LV5237JA is a 9-channel LED driver IC that is capable of switching between constant-current output and open drain output. Peak output current is $I_{O \text{ max}}=100\text{mA}$. It enables 2-wire/3-wire serial bus control (address designation) to be set arbitrarily using an external pin. Also possible are 9-channel LED ON/OFF control and the setting of the PWM luminance in 256 steps.

Up to 81 driver ICs can be connected using the slave address setting pins.

Function

- 9-channel output constant-current LED driver/open drain output LED driver (selected by using an external pin)
Supports separate ON/OFF setting for each LED output, high withstand voltage ($V_{OUT}<42\text{V}$)
- In the constant-current mode (OUTSCT: L), the reference current is set by the value of resistor connected to the external pin (RT1).
 - Built-in D/A (5 bits) for switching current level
... 0.86mA to 31.24mA (RGB drive)
 - Constant current ($I_{O \text{ max}}=100\text{mA}$) for full-color LEDs \times 9 channels
- In the open drain mode (OUTSCT: H), high current drive ($I_{O \text{ max}}=100\text{mA}$) \times 9 channels
- In the constant-current mode (OUTSCT: M)
Only RGB3 is open drain ($I_{O \text{ max}}=100\text{mA}$)
- Luminance adjustment using internal PWM control (256 steps), It copes with independent PWM control for each LED output
 - 8-bit PWM luminance dimming (0% to 99.6%)
 - 3-phase PWM
- Selection of 2-wire/ 3-wire serial bus control signals enabled (switching using an external pin)
 - Schmitt trigger input (3.3V/5V)
- Slave addressing (4 bits, connection of up to 81 driver ICs possible)
- Input Power supply supports 12V
 - Internal reference output terminal (5V)
- Low current consumption
- Output malfunction protection circuits (thermal protection function, UVLO detection protection function, Power on RESET)

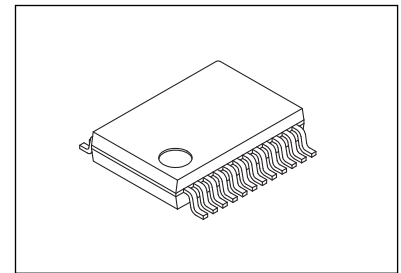

SSOP24 (225mil)

ORDERING INFORMATION

See detailed ordering and shipping information on page 23 of this data sheet.

Specifications

Absolute Maximum Ratings at Ta = 25°C

Parameter	Symbol	Conditions	Ratings	Unit
Maximum supply voltage	V _{CC} max		13.6	V
	V _{LED}	V _{LED}	42	V
	V _{REF}	V _{REF}	5.8	V
Output voltage	V _O max	LED off	42	V
Output current	I _O max	Open drain	100	mA
Allowable power dissipation	P _d max	Ta ≤ 25°C *	1.22	W
Operating temperature	T _{opr}		-25 to +85	°C
Storage temperature	T _{stg}		-40 to +150	°C

* Specified board: 114.3mm × 76.1mm × 1.6mm, glass epoxy board. Exposed Die-pad area is not a substrate mounting.

[Warning] : If you should intend to use this IC continuously under high temperature, high current, high voltage, or drastic temperature change, even if it is used within the range of absolute maximum ratings or operating conditions, there is a possibility of decrease reliability. Please contact us for a confirmation.

Stresses exceeding those listed in the Maximum Ratings table may damage the device. If any of these limits are exceeded, device functionality should not be assumed, damage may occur and reliability may be affected.

Recommended Operating Conditions at Ta = 25°C

Parameter	Symbol	Conditions	Ratings	Unit
Operating supply voltage range	V _{CC} op	SV _{CC}	3.1 to 12.8	V
	V _{LED} op	V _{LED}	3.1 to 42	V
	V _{REF} op	V _{REF}	3.1 to 5.5	V

[Warning] : The V_{LED} terminal becomes the terminal for protection of the LED drive output. Please be connected to the power supply same as LED drive. When IC power supply (SV_{CC}) and power supply of the LED or two kinds of power supply is more than it, please connect V_{LED} to the highest potential and the power supply that it is.

Functional operation above the stresses listed in the Recommended Operating Ranges is not implied. Extended exposure to stresses beyond the Recommended Operating Ranges limits may affect device reliability.

Electrical Characteristics at Ta = 25°C, V_{CC} = 5V (=V_{REF})

Parameter	Symbol	Conditions	Ratings			Unit
			min	typ	max	
Consumption current	I _{CC} 1	LED off	1.0	1.8	2.9	mA
Reference current pin voltage	V _{RT}	RT1=20kΩ	1.14	1.22	1.30	V
MAX output current	ΔI _L	V _O =0.7 to 4.0V(Same channel line regulation)	-10			%
Between bits output current	ΔI _{OL}	I _O =31.24mA (Between bits pairing characteristics)			5	%
Maximum LED driver output current 1	I _{MAX} 1	RT1=20kΩ LED OUTSCT= L	29.36	31.24	33.12	mA
LED output on resistance 1	R _{on} 1	I _O = 10mA		10	20	Ω
OFF leak current	I _{leak}	LED OFF			10	μA
Power on RESET voltage	V _{POR}	The voltage that is canceled		2.5		V
Reset voltage	V _{RST}	UVLO voltage		2.3		V
V _{REF} voltage	V _{REF}	V _{REF} =open		4.9		V
V _{REF} voltage	V _{REF} 1	V _{CC} = 6.0V, I _O = 10mA	4.7	5.1	5.4	V
Oscillator frequency	F _{osc}			1000		kHz

*Power on RESET
Reset all the data in the IC at the time of power activation. And it becomes the default setting.

*UVLO detection protection function
When SV_{CC} decreases, it turns off LED output terminal.

* Thermal protection function
When a temperature in the IC rises, it turns off output terminal. When temperature falls, it returns by oneself.

Product parametric performance is indicated in the Electrical Characteristics for the listed test conditions, unless otherwise noted. Product performance may not be indicated by the Electrical Characteristics if operated under different conditions.

LV5237JA

Control circuit at Ta = 25°C, VCC = 5.0V (=VREF)

Parameter	Symbol	Conditions	Ratings			Unit
			min	typ	max	
H level 1	VH1	Input H level OUTSCT	4.5		5.0	V
M level 1	VM1	Input M level OUTSCT	1.8		3.0	V
L level 1	VL1	Input L level OUTSCT	-0.2		0.5	V
H level 2	VH2	Input H level CTLSCT	3.5		5.0	V
L level 2	VL2	Input L level CTLSCT	-0.2		0.5	V
H level 3	VH3	Input H level SCLK, SDATA, SDEN	4.0		5.0	V
L level 3	VL3	Input L level SCLK, SDATA, SDEN	-0.2		1.0	V
H level 4	VH4	Input H level A0 to A3	4.5		5.0	V
M level 4	VM4	Input H level A0 to A3	1.8		3.0	V
L level 4	VL4	Input L level A0 to A3	-0.2		0.5	V

Electrical Characteristics at Ta = 25°C, VCC = 3.3V (=VREF)

Parameter	Symbol	Conditions	Ratings			Unit
			min	typ	max	
Consumption current	ICC2	LED off		1.6		mA
Reference current pin voltage	VRT	RT1=20kΩ	1.14	1.22	1.30	V
MAX output current	ΔIL	VO=0.7 to 4.0V(Same channel line regulation)	-10			%
Between bits output current	ΔIOL	IO=31.24mA (Between bits pairing characteristics)			5	%
Maximum LED driver output current 1	IMAX1	RT1=20kΩ LED OUTSCT= L		31.24		mA
LED output on resistance 1	Ron1	IO = 10mA		10	20	Ω
OFF leak current	Ileak	LED OFF			10	μA
Power on RESET voltage	VPOR	The voltage that is canceled		2.5		V
Reset voltage	VRST	UVLO voltage		2.3		V
VREF voltage	VREF	VREF=open		3.2		V
Oscillator frequency	Fosc			1000		kHz

Product parametric performance is indicated in the Electrical Characteristics for the listed test conditions, unless otherwise noted. Product performance may not be indicated by the Electrical Characteristics if operated under different conditions.

Control circuit at Ta = 25°C, VCC = 3.3V (=VREF)

Parameter	Symbol	Conditions	Ratings			Unit
			min	typ	max	
H level 1	VH1	Input H level OUTSCT	2.8		3.3	V
M level 1	VM1	Input M level OUTSCT	1.2		1.7	V
L level 1	VL1	Input L level OUTSCT	-0.2		0.5	V
H level 2	VH2	Input H level CTLSCT	2.3		3.3	V
L level 2	VL2	Input L level CTLSCT	-0.2		0.5	V
H level 3	VH3	Input H level SCLK, SDATA, SDEN	2.7		3.3	V
L level 3	VL3	Input L level SCLK, SDATA, SDEN	-0.2		0.6	V
H level 4	VH4	Input H level A0 to A3	2.8		3.3	V
M level 4	VM4	Input H level A0 to A3	1.35		1.8	V
L level 4	VL4	Input L level A0 to A3	-0.2		0.5	V

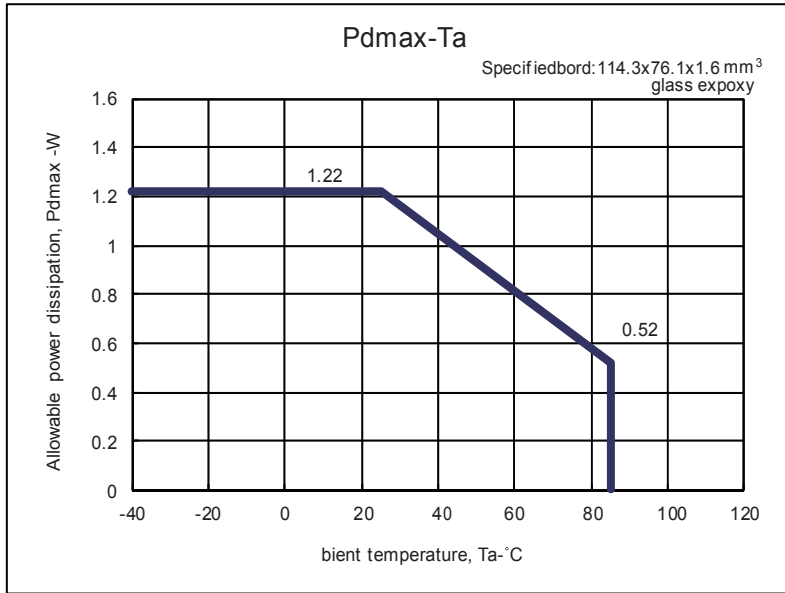

Block Diagram

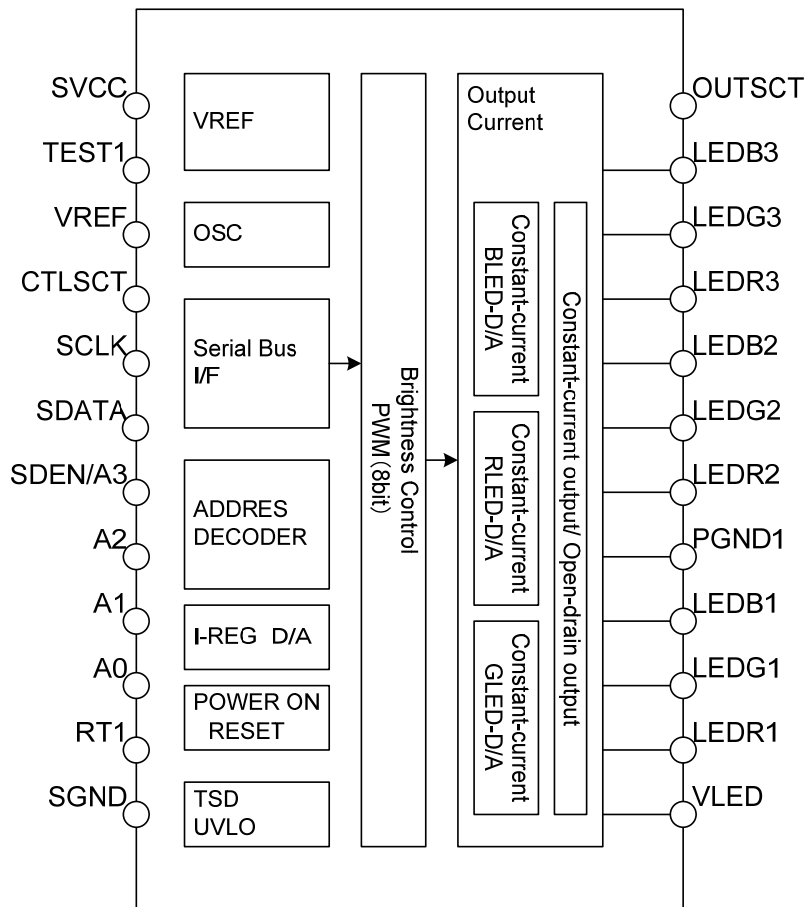

[Warning] : The VLED terminal becomes the terminal for protection of the LED drive output. Please be connected to the power supply same as LED drive. When IC power supply (SVCC) and power supply of the LED or two kinds of power supply is more than it, please connect VLED to the highest potential and the power supply that it is.

Pin Assignment

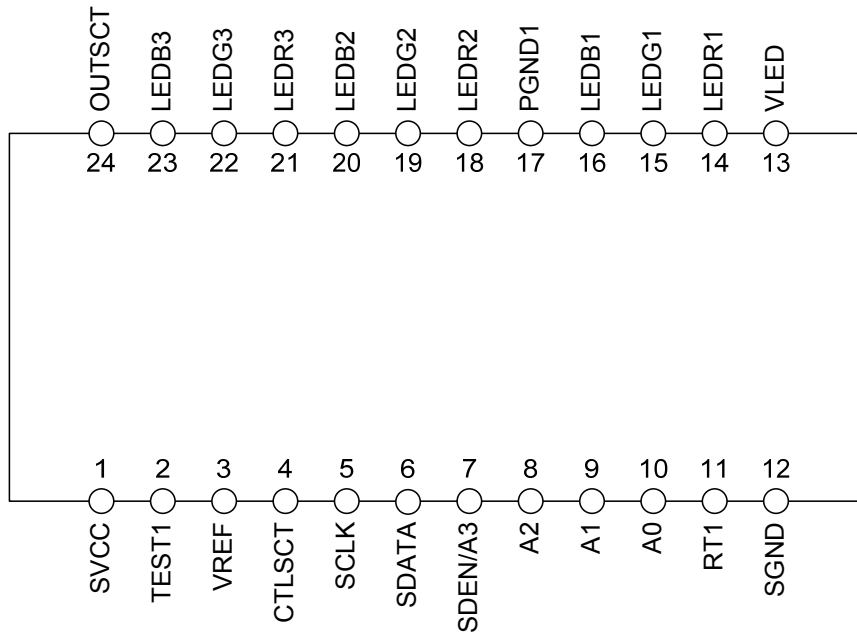

Pin Descriptions

Pin No.	Pin name	I/O	Description
1	SVCC	-	Power supply pin
2	TEST1	I	Test1 pin (connected to GND)
3	VREF	O	5V reference output pin
4	CTLSCT	I	2-wire serial bus/3-wire serial bus selecting control pin (L: 3-wire serial, H: 2-wire serial)
5	SCLK	I	Serial clock signal input pin
6	SDATA	I	Serial data signal input pin
7	SDEN/A3	I	Serial enable signal input pin / Slave address input pin A3
8	A2	I	Slave address input pin A2
9	A1	I	Slave address input pin A1
10	A0	I	Slave address input pin A0
11	RT1	O	LED current setting resistor connection pin
12	SGND	-	Analog circuit GND pin
13	VLED	-	Output protection pin
14	LEDR1	O	LEDR1 output pin
15	LEDG1	O	LEDG1 output pin
16	LEDB1	O	LEDB1 output pin
17	PGND1	-	GND pin dedicated for LED driver
18	LEDR2	O	LEDR2 output pin
19	LEDG2	O	LEDG2 output pin
20	LEDB2	O	LEDB2 output pin
21	LEDR3	O	LEDR3 output pin
22	LEDG3	O	LEDG3 output pin
23	LEDB3	O	LEDB3 output pin
24	OUTSCT	I	Output type switching control pin L: Constant-current output M: Constant output, only RGB3 is open drain output H: Open drain output

OUTSCT Settings

	LED Driver Output Pin	
OUTSCT pin	LEDR1/ LEDR2 LEDG1/ LEDG2 LEDB1/ LEDB2	LEDR3 LEDG3 LEDB3
L	Constant current output Built-in current value switching D/A (5 bits) 0.86mA to 31.24mA, RT1=20kΩ (f=1MHz)	Constant current output Built-in current value switching D/A (5 bits) 0.86mA to 31.24mA, RT1=20kΩ (f=1MHz)
H	Open drain output Current value is determined by external limiting resistor. R _{ON} =10Ω	Open drain output Current value is determined by external limiting resistor. R _{ON} =10Ω
M	Constant current output Built-in current value switching D/A (5 bits) 0.86mA to 31.24mA, RT1=20kΩ (f=1MHz)	Open drain output Current value is determined by external limiting resistor. R _{ON} =10Ω

Power on RESET Settings

It has power-on reset circuit built-in, and, at the time of power activation, the air resistor data of the IC is reset.
It prevents malfunction of the LED lighting by letting you reset it.
When voltage rises from state of SVCC=0V, the power-on reset becomes effective.
Please start to reboot it after making SVCC=0V.

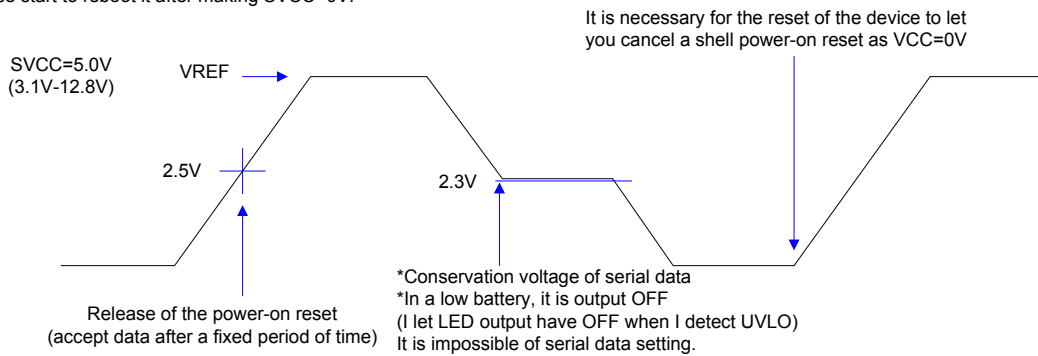

When you transmit data after a release of the power-on reset, please transmit it after being able to open interval more than 100usec.

Pin Functions

Pin No.	Pin Name	Pin function	Equivalent Circuit
1	SVCC	Power supply pin	
2	TEST1	Test1 pin This pin must always be connected to GND.	
3	VREF	Reference output pin(5V)	
4	CTLSCT	Serial bus communication setting pin When set to low: The 3-wire serial bus signals are set as the input signals. When set to high: The 2-wire serial bus signals are set as the input signals.	

LV5237JA

5 6 7	SCLK SDATA SDEN/ A3	Serial clock signal input pin Serial data signal input pin Serial enable signal input pin/ Slave address setting pin A3	
8 9 10	A2 A1 A0	Slave address setting pin A2 Slave address setting pin A1 Slave address setting pin A0	
11	RT1	Reference current setting resistor connection pin. By connecting the external register between this pin and GND, the reference current is generated. The pin voltage is approximately 1.22V. By changing the current level, it is possible to change the oscillator frequency and LED driver current value (in the constant-current mode).	
12	SGND	GND pin	
13	VLED	Output protection pin	
14 15 16 18 19 20 21 22 23	LEDR1 LEDG1 LEDB1 LEDR2 LEDG2 LEDB2 LEDR3 LEDG3 LEDB3	LEDR1 output pin LEDG1 output pin LEDB1 output pin LEDR2 output pin LEDG2 output pin LEDB2 output pin LEDR3 output pin LEDG3 output pin LEDB3 output pin If these pins are not going to be used, they must always be connected to GND.	
17	PGND1	GND pin dedicate for LED output	
24	OUTSCT	LED driver output type setting pin When set to low: Constant-current output is set for the LED driver. When set to high: Open drain output is set for the LED driver. When set to middle: Constant-current output is set for the LED driver. However, open drain output is set for the only LED3 driver.	

Serial Bus Communication Specifications

1) Serial bus transfer timing conditions

Parameter	Symbol	Conditions	Min.	Typ.	Max.	Unit
Cycle time	tcyl	SCLK clock period	200	-	-	ns
Data setup time	ts0	SDEN setup time relative to the rise of SCLK	90	-	-	ns
	ts1	SDATA setup time relative to the rise of SCLK	60	-	-	ns
Data hold time	th0	SDEN hold time relative to the fall of SCLK	200	-	-	ns
	th1	SDATA hold time relative to the fall of SCLK	60	-	-	ns
Pulse width	tw1L	Low period pulse width of SCLK	90	-	-	ns
	tw1H	High period pulse width of SCLK	90	-	-	ns
	tw2L	Low period pulse width of SDEN	1	-	-	μs

2) 3-wire serial bus transfer formats

LV5237JA receives the command by communication format by 3 line type serial communication of SCLK, SDATA, and SDEN.

When SCLK stops in “L” level

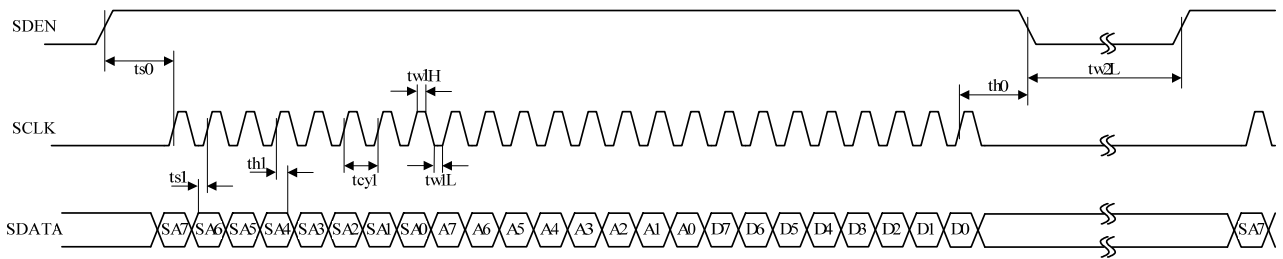

When SCLK stops in “H” level

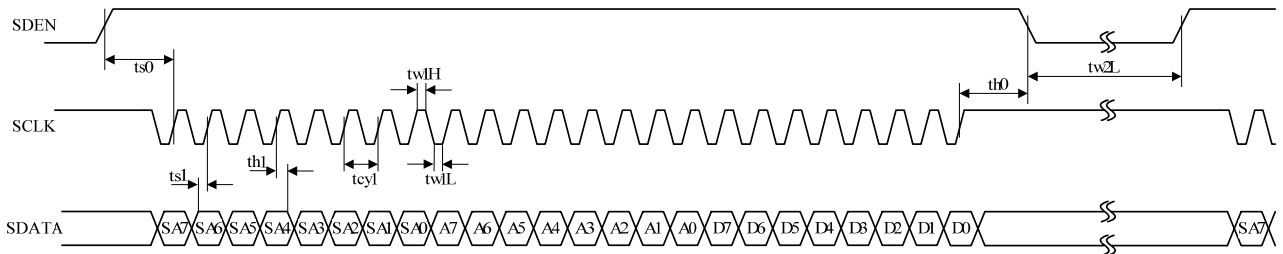

Data length : 24bits

Clock frequency : 5MHz or less

When 24 SCLK clock signals have been input during the high period of SDEN, the SDATA is taken in at the rising edge of SCLK.

Note: If the number of SCLK clock signals during the high period of SDEN is 23 or less, SDATA is not taken in. If it is 25 or more, the register address is automatically incremented every time 1byte is taken in.

Data organization

The slave address is assigned by the first byte, and the register address on the serial map is specified by the next byte. The third byte transfers the data to the address specified by the register address that was written by the second byte and if the data subsequently continues even after this, the register address is automatically incremented for the fourth and subsequent bytes. As a result, it is possible to send the data continuously from the specified addresses. Data of less than one byte is ignored. However, when the address reaches 0fh, the next byte to be transferred becomes 00h.

Serial data transfer example (slave address=0000 001-)

When I set register address 02h and write in data (the smallest data length)

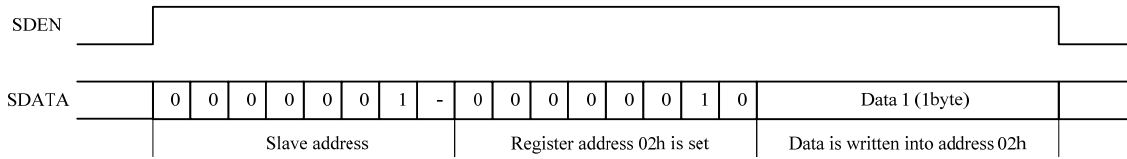

When I set register address 02h and write in data for 3 bytes

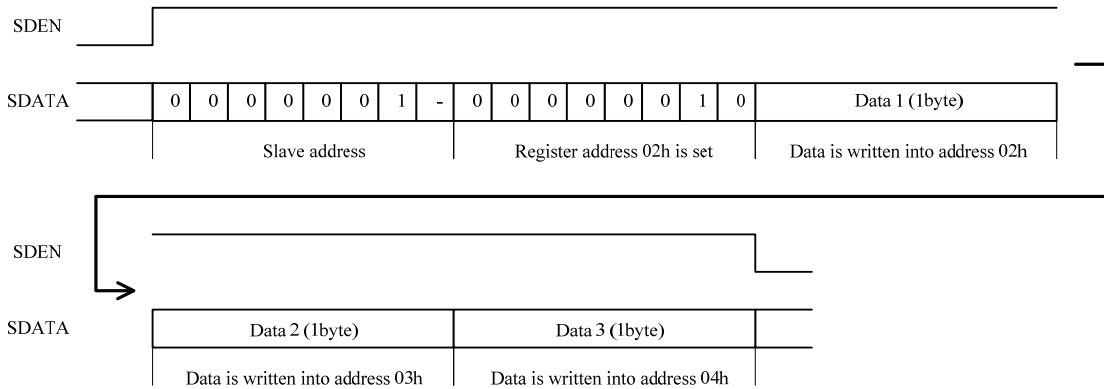

When I set register address 02h and write in data for 3 byte, and following data is less than a signal byte

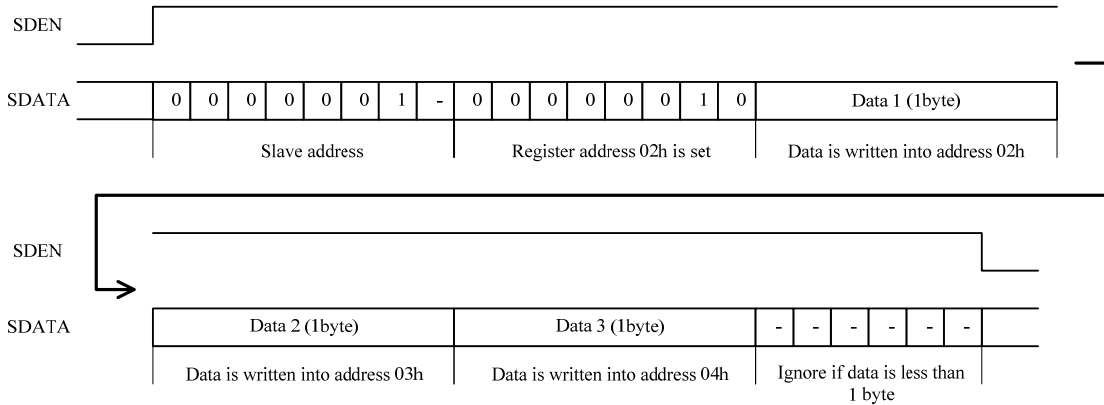

When slave address does not accord

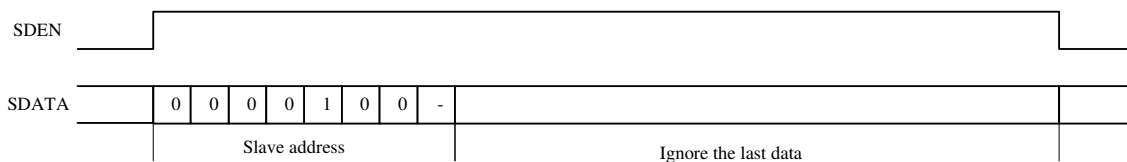

3) 2-wire serial bus transfer formats

LV5237JA receives the command by communication format by 2 line type serial communication of SCLK, SDATA.

When SCLK stops in “L” level

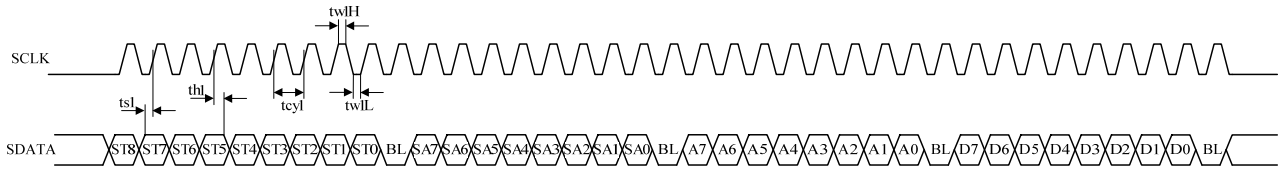

When SCLK stops in “H” level

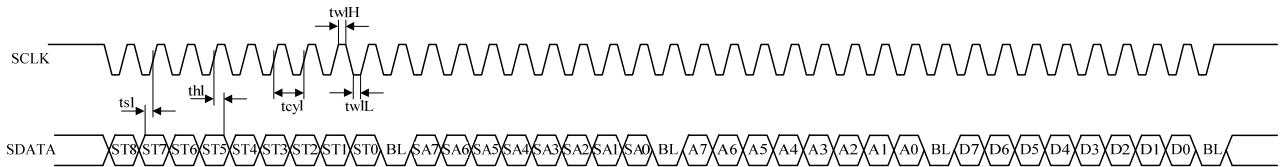

Data length : 37bits

Start condition (“11111111”) + BLANK (“0”) + Slave address (8bit) + BLANK + (“0”) + Resister address (8bit) + BLANK (“0”) + Data (8bit) + BLANK (“0”)

Clock frequency : 5MHz or less

After start detection, it takes SDATA in the timing when the 27th clock track of SCLK stands up when sign according to communication format is input into SCLK and SDATA.

Note: When SCLK is less than 27th clock track, and BLANK is different from communication format such as “1”, after start detection, do not take in SDATA.

When SCLK is higher than 28th clock track, start detection is confirmed, or it is automatic, and register address is incremented every 1byte (8bit) + BLANK (“0”) unless BLANL is “1”.

Data organization

bit	ST8	ST7	ST6	ST5	ST4	ST3	ST2	ST1	ST0	BL	SA7	SA6	SA5	SA4	SA3	SA2	SA1	SA0	BL	A7	A6	A5	A4	A3	A2	A1	A0	BL	D7	D6	D5	D4	D3	D2	D1	D0	BL	
SDATA	1	1	1	1	1	1	1	1	1	0	0	0						-	0									0									0	
Parameter	Start condition										BLANK	Slave address								BLANK	Register address								BLANK	Data								BLANK

Even if SCLK and SDATA are state such as among standby or serial data inward correspondences, “11111111” start assumption and BLANK”0” start the uptake atomic act of new serial data after detection (start detection) was considered to be it.

After start detection, the first single byte (8bit) is assigned to slave address, and a write store of the slave address completes it in BLANK”0”.

The next single byte appoints register address in the serial manufacturing auto protocol, and a write of the register address is completed in BLANK”0”.

The third byte performs a data transfer to the address which it appointed in the register address which it wrote in at the second byte and it complete data transfer in BLANK”0” and write in it. When data continues after this, register address is automatically incremented after the fourth byte and a data transfer is completed each time and, in BLANK”0”, writes in it.

Data Forward continuous from designated register address is enabled, but, as for the redirecting address of the next byte, it is in this way with for “00h” when register address becomes “0fh”.

In addition, when serial data uptake BLANK is “1”, including slave address selection and register address assignment, the single byte data just before it is ignored without being written in, and the subsequent data is ignored until it is detected a start.

Serial data transfer example (slave address=0000 001-)

When I set register address 02h and write in data (the smallest data length)

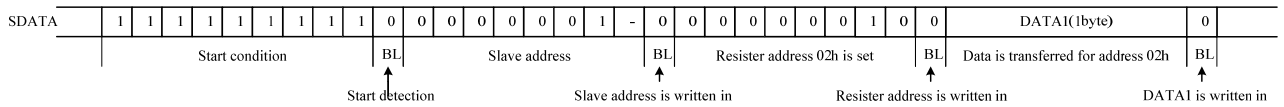

When I set register address 02h and write in data for 3 bytes

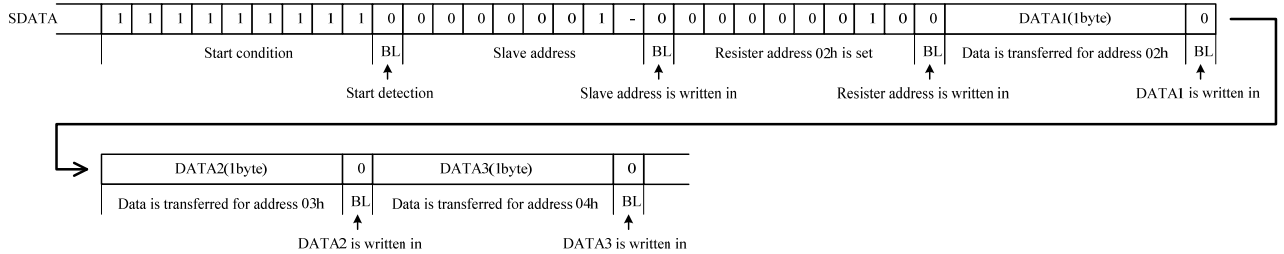

When I set register address 02h and write in data for 1 byte, and BLANK after the following byte in the case of "1"

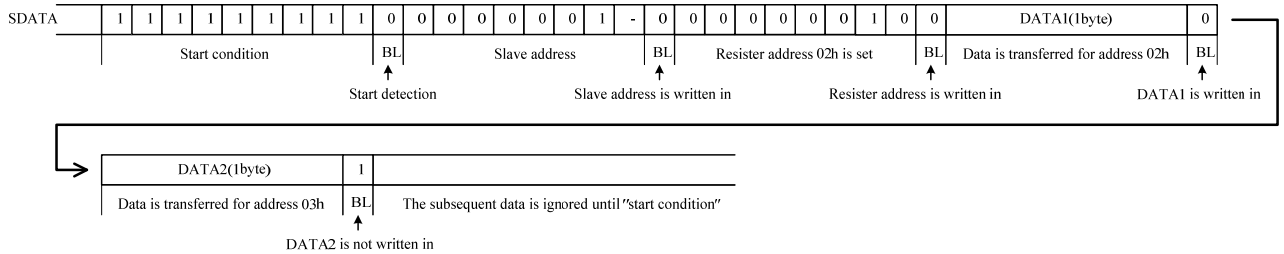

When I set register address 02h, but BLANK after the byte in the case of "1"

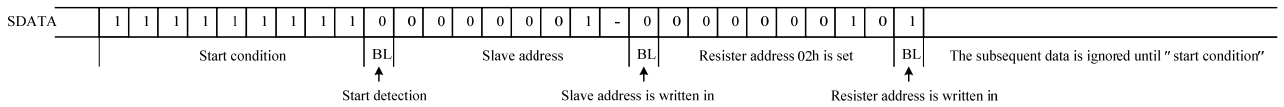

When slave address does not accord

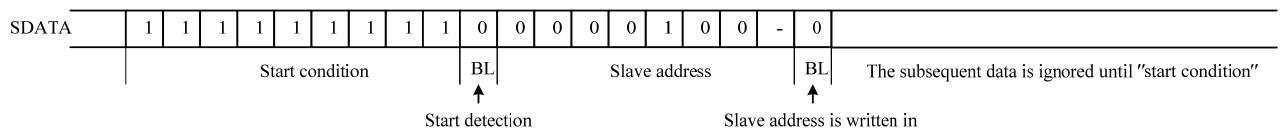

SDATA continues more than 10bit; and in the case of 1 "" (start detection of this case)

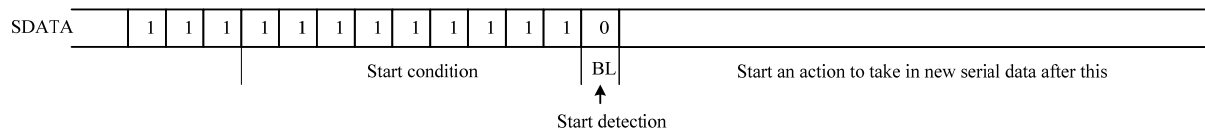

LV5237JA

Slave address condition

	SLAVE ADDRESS							
	SA7	SA6	SA5	SA4	SA3	SA2	SA1	SA0
resister name	-	-	-	A3	A2	A1	A0	-
default	0	0	0	0	0	0	0	-

Terminal PIN				
	A3	A2	A1	A0
	L	L	L	L
	L	L	L	M
	L	L	L	H
	L	L	M	L
	L	L	M	M
	L	L	M	H
	L	L	H	L
	L	L	H	M
	L	L	H	H
	L	M	L	L
	L	M	L	M
	L	M	L	H
	L	M	M	L
	L	M	M	M
	L	M	M	H
	L	M	H	L
	L	M	H	M
	L	M	H	H
	L	H	L	L
	L	H	L	M
	L	H	L	H
	L	H	M	L
	L	H	M	M
	L	H	M	H
	L	H	H	L
	L	H	H	M
	L	H	H	H
	M	L	L	L
	M	L	L	M
	M	L	L	H
	M	L	M	L
	M	L	M	M
	M	L	M	H
	M	L	H	L
	M	L	H	M
	M	L	H	H
	M	M	L	L
	M	M	L	M
	M	M	L	H
	M	M	M	L
	M	M	M	M
	M	M	M	H
	M	M	H	L
	M	M	H	M
	M	M	H	H
	M	H	L	L
	M	H	L	M
	M	H	L	H
	M	H	M	L

SA7	SA6	SA5	SA4	SA3	SA2	SA1	SA0
0	0	0	0	0	0	0	-
0	0	0	0	0	0	1	-
0	0	0	0	0	1	0	-
0	0	0	0	0	1	1	-
0	0	0	0	1	0	0	-
0	0	0	0	1	0	1	-
0	0	0	0	1	1	0	-
0	0	0	0	1	1	1	-
0	0	0	1	0	0	0	-
0	0	0	1	0	0	1	-
0	0	0	1	0	1	0	-
0	0	0	1	0	1	1	-
0	0	0	1	1	0	0	-
0	0	0	1	1	1	1	-
0	0	1	0	0	0	0	-
0	0	1	0	0	0	1	-
0	0	1	0	0	1	0	-
0	0	1	0	0	1	1	-
0	0	1	0	1	0	0	-
0	0	1	0	1	0	1	-
0	0	1	0	1	1	0	-
0	0	1	1	0	0	0	-
0	0	1	1	0	0	1	-
0	0	1	1	0	1	0	-
0	0	1	1	1	1	1	-
0	0	1	1	1	0	0	-
0	0	1	1	1	1	0	-
0	0	1	1	1	1	1	-
0	1	0	0	0	0	0	-
0	1	0	0	0	0	1	-
0	1	0	0	0	1	0	-
0	1	0	0	1	0	0	-
0	1	0	0	1	1	0	-
0	1	0	0	1	1	1	-
0	1	0	1	0	0	0	-
0	1	0	1	0	0	1	-
0	1	0	1	1	0	0	-
0	1	0	1	1	1	0	-
0	1	0	1	1	1	1	-
0	1	1	0	0	0	0	-

:LV5237

1
2
3
4
5
6
7
8
9
10
11
12
13
14
15
16
17
18
19
20
21
22
23
24
25
26
27
28
29
30
31
32
33
34
35
36
37
38
39
40
41
42
43
44
45
46
47
48
49

LV5237JA

Terminal PIN				
	A3	A2	A1	A0
	M	H	M	M
	M	H	M	H
	M	H	H	L
	M	H	H	M
	M	H	H	H
	H	L	L	L
	H	L	L	M
	H	L	L	H
	H	L	M	L
	H	L	M	M
	H	L	M	H
	H	L	H	L
	H	L	H	M
	H	L	H	H
	H	M	L	L
	H	M	L	M
	H	M	L	H
	H	M	M	L
	H	M	M	M
	H	M	M	H
	H	M	H	L
	H	M	H	M
	H	M	H	H
	H	H	L	L
	H	H	L	M
	H	H	L	H
	H	H	M	L
	H	H	M	M
	H	H	M	H
	H	H	H	L
	H	H	H	M
	H	H	H	H

SA7	SA6	SA5	SA4	SA3	SA2	SA1	SA0	
0	1	1	0	0	0	1	-	50
0	1	1	0	0	1	0	-	51
0	1	1	0	0	1	1	-	52
0	1	1	0	1	0	0	-	53
0	1	1	0	1	0	1	-	54
0	1	1	0	1	1	0	-	55
0	1	1	0	1	1	1	-	56
0	1	1	1	0	0	0	-	57
0	1	1	1	0	0	1	-	58
0	1	1	1	0	1	0	-	59
0	1	1	1	0	1	1	-	60
0	1	1	1	1	0	0	-	61
0	1	1	1	1	0	1	-	62
0	1	1	1	1	1	0	-	63
0	1	1	1	1	1	1	-	64
1	1	0	0	0	0	0	-	65
1	1	0	0	0	0	1	-	66
1	1	0	0	0	1	0	-	67
1	1	0	0	0	1	1	-	68
1	1	0	0	1	0	0	-	69
1	1	0	0	1	0	1	-	70
1	1	0	0	1	1	0	-	71
1	1	0	0	1	1	1	-	72
1	1	0	1	0	0	0		73
1	1	0	1	0	0	1		74
1	1	0	1	0	1	0		75
1	1	0	1	0	1	1		76
1	1	0	1	1	0	0		77
1	1	0	1	1	0	1		78
1	1	0	1	1	1	0		79
1	1	0	1	1	1	1		80
1	1	1	0	0	0	0		81

LV5237JA

Slave address condition

	SLAVE ADDRESS							
	SA7	SA6	SA5	SA4	SA3	SA2	SA1	SA0
resister name	-	-	-	-	A2	A1	A0	-
default	0	0	0	0	0	0	0	-

Terminal PIN				
	A2	A1	A0	
	L	L	L	
	L	L	M	
	L	L	H	
	L	M	L	
	L	M	M	
	L	M	H	
	L	H	L	
	L	H	M	
	L	H	H	
	M	L	L	
	M	L	M	
	M	L	H	
	M	M	L	
	M	M	M	
	M	M	H	
	M	H	L	
	M	H	M	
	M	H	H	
	H	L	L	
	H	L	M	
	H	L	H	
	H	M	L	
	H	M	M	
	H	M	H	
	H	H	L	
	H	H	M	
	H	H	H	

SA7	SA6	SA5	SA4	SA3	SA2	SA1	SA0	
0	0	0	0	0	0	0	-	1
0	0	0	0	0	0	1	-	2
0	0	0	0	0	1	0	-	3
0	0	0	0	0	1	1	-	4
0	0	0	0	1	0	0	-	5
0	0	0	0	1	0	1	-	6
0	0	0	0	1	1	0	-	7
0	0	0	0	1	1	1	-	8
0	0	0	1	0	0	0	-	9
0	0	0	1	0	0	1	-	10
0	0	0	1	0	1	0	-	11
0	0	0	1	0	1	1	-	12
0	0	0	1	1	0	0	-	13
0	0	0	1	1	0	1	-	14
0	0	0	1	1	1	0	-	15
0	0	0	1	1	1	1	-	16
0	0	1	0	0	0	0	-	17
0	0	1	0	0	0	1	-	18
0	0	1	0	0	1	0	-	19
0	0	1	0	0	1	1	-	20
0	0	1	0	1	0	0	-	21
0	0	1	0	1	0	1	-	22
0	0	1	0	1	1	0	-	23
0	0	1	0	1	1	1	-	24
0	0	1	1	0	0	0	-	25
0	0	1	1	0	0	1	-	26
0	0	1	1	0	1	0	-	27

:LV5237

LV5237JA

Serial each mode setting

	ADDRESS : 00h							
	D7	D6	D5	D4	D3	D2	D1	D0
register name	-	-	-	-	-	PWM[2]	PWM[1]	PWM[0]
default	0	0	0	0	0	0	0	0

D7	D6	D5	time(ms)
0	0	0	0.5
0	0	1	1.0
0	1	0	2.0
0	1	1	4.0
1	0	0	8.0
-	-	-	-
-	-	-	-
-	-	-	-
-	-	-	-

PWM cycle setting

*Default

LV5237JA

	ADDRESS : 01h							
	D7	D6	D5	D4	D3	D2	D1	D0
register name	R3OUT	R2OUT	R1OUT	RLED[4]	RLED[3]	RLED[2]	RLED[1]	RLED[0]
default	0	0	0	0	0	0	0	0

D7	R3OUT
0	PWM mode-Duty setting
1	100%-Duty setting

LEDR3 output duty setting
* Default

D6	R2OUT
0	PWM mode-Duty setting
1	100%-Duty setting

LEDR2 output duty setting
* Default

D5	R1OUT
0	PWM mode-Duty setting
1	100%-Duty setting

LEDR1 output duty setting
* Default

D4	D3	D2	D1	D0	Current value (mA)
0	0	0	0	0	0.86
0	0	0	0	1	1.84
0	0	0	1	0	2.82
0	0	0	1	1	3.80
0	0	1	0	0	4.78
0	0	1	0	1	5.76
0	0	1	1	0	6.74
0	0	1	1	1	7.72
0	1	0	0	0	8.70
0	1	0	0	1	9.68
0	1	0	1	0	10.68
0	1	0	1	1	11.64
0	1	1	0	0	12.62
0	1	1	0	1	13.60
0	1	1	1	0	14.58
0	1	1	1	1	15.56
1	0	0	0	0	16.54
1	0	0	0	1	17.52
1	0	0	1	0	18.50
1	0	0	1	1	19.48
1	0	1	0	0	20.46
1	0	1	0	1	21.44
1	0	1	1	0	22.42
1	0	1	1	1	23.40
1	1	0	0	0	24.38
1	1	0	0	1	25.36
1	1	0	1	0	26.34
1	1	0	1	1	27.32
1	1	1	0	0	28.30
1	1	1	0	1	29.28
1	1	1	1	0	30.26
1	1	1	1	1	31.24

RLED current value setting
* Default

LV5237JA

	ADDRESS : 02h							
	D7	D6	D5	D4	D3	D2	D1	D0
register name	G3OUT	G2OUT	G1OUT	GLED[4]	GLED[3]	GLED[2]	GLED[1]	GLED[0]
default	0	0	0	0	0	0	0	0

D7	G3OUT
0	PWM mode-Duty setting
1	100%-Duty setting

LEDG3 output duty setting
* Default

D6	G2OUT
0	PWM mode-Duty setting
1	100%-Duty setting

LEDG2 output duty setting
* Default

D5	G1OUT
0	PWM mode-Duty setting
1	100%-Duty setting

LEDG1 output duty setting
* Default

D4	D3	D2	D1	D0	Current value (mA)
0	0	0	0	0	0.86
0	0	0	0	1	1.84
0	0	0	1	0	2.82
0	0	0	1	1	3.80
0	0	1	0	0	4.78
0	0	1	0	1	5.76
0	0	1	1	0	6.74
0	0	1	1	1	7.72
0	1	0	0	0	8.70
0	1	0	0	1	9.68
0	1	0	1	0	10.68
0	1	0	1	1	11.64
0	1	1	0	0	12.62
0	1	1	0	1	13.60
0	1	1	1	0	14.58
0	1	1	1	1	15.56
1	0	0	0	0	16.54
1	0	0	0	1	17.52
1	0	0	1	0	18.50
1	0	0	1	1	19.48
1	0	1	0	0	20.46
1	0	1	0	1	21.44
1	0	1	1	0	22.42
1	0	1	1	1	23.40
1	1	0	0	0	24.38
1	1	0	0	1	25.36
1	1	0	1	0	26.34
1	1	0	1	1	27.32
1	1	1	0	0	28.30
1	1	1	0	1	29.28
1	1	1	1	0	30.26
1	1	1	1	1	31.24

GLED current value setting
* Default

LV5237JA

	ADDRESS : 03h							
	D7	D6	D5	D4	D3	D2	D1	D0
register name	B3OUT	B2OUT	B1OUT	BLED[4]	BLED[3]	BLED[2]	BLED[1]	BLED[0]
default	0	0	0	0	0	0	0	0

D7	B3OUT
0	PWM mode-Duty setting
1	100%-Duty setting

LEDB3 output duty setting
* Default

D6	B2OUT
0	PWM mode-Duty setting
1	100%-Duty setting

LEDB2 output duty setting
* Default

D5	B1OUT
0	PWM mode-Duty setting
1	100%-Duty setting

LEDB1 output duty setting
* Default

D4	D3	D2	D1	D0	Current value (mA)
0	0	0	0	0	0.86
0	0	0	0	1	1.84
0	0	0	1	0	2.82
0	0	0	1	1	3.80
0	0	1	0	0	4.78
0	0	1	0	1	5.76
0	0	1	1	0	6.74
0	0	1	1	1	7.72
0	1	0	0	0	8.70
0	1	0	0	1	9.68
0	1	0	1	0	10.68
0	1	0	1	1	11.64
0	1	1	0	0	12.62
0	1	1	0	1	13.60
0	1	1	1	0	14.58
0	1	1	1	1	15.56
1	0	0	0	0	16.54
1	0	0	0	1	17.52
1	0	0	1	0	18.50
1	0	0	1	1	19.48
1	0	1	0	0	20.46
1	0	1	0	1	21.44
1	0	1	1	0	22.42
1	0	1	1	1	23.40
1	1	0	0	0	24.38
1	1	0	0	1	25.36
1	1	0	1	0	26.34
1	1	0	1	1	27.32
1	1	1	0	0	28.30
1	1	1	0	1	29.28
1	1	1	1	0	30.26
1	1	1	1	1	31.24

BLED current value setting
* Default

LV5237JA

	ADDRESS : 04h							
	D7	D6	D5	D4	D3	D2	D1	D0
register name	R1PWM[7]	R1PWM[6]	R1PWM[5]	R1PWM[4]	R1PWM[3]	R1PWM[2]	R1PWM[1]	R1PWM[0]
default	0	0	0	0	0	0	0	0

LEDR1 PWM Duty setting (Default ALL0)

D	Duty (%)
00h	0.0
ffh	99.6

$$\text{Duty (\%)} = \frac{\text{R1PWM}[7:0]}{256}$$

	ADDRESS : 05h							
	D7	D6	D5	D4	D3	D2	D1	D0
register name	G1PWM[7]	G1PWM[6]	G1PWM[5]	G1PWM[4]	G1PWM[3]	G1PWM[2]	G1PWM[1]	G1PWM[0]
default	0	0	0	0	0	0	0	0

LEDG1 PWM Duty setting (Default ALL0)

D	Duty (%)
00h	0.0
ffh	99.6

$$\text{Duty (\%)} = \frac{\text{G1PWM}[7:0]}{256}$$

	ADDRESS : 06h							
	D7	D6	D5	D4	D3	D2	D1	D0
register name	B1PWM[7]	B1PWM[6]	B1PWM[5]	B1PWM[4]	B1PWM[3]	B1PWM[2]	B1PWM[1]	B1PWM[0]
default	0	0	0	0	0	0	0	0

LEDB1 PWM Duty setting (Default ALL0)

D	Duty (%)
00h	0.0
ffh	99.6

$$\text{Duty (\%)} = \frac{\text{B1PWM}[7:0]}{256}$$

	ADDRESS : 07h							
	D7	D6	D5	D4	D3	D2	D1	D0
register name	R2PWM[7]	R2PWM[6]	R2PWM[5]	R2PWM[4]	R2PWM[3]	R2PWM[2]	R2PWM[1]	R2PWM[0]
default	0	0	0	0	0	0	0	0

LEDR2 PWM Duty setting (Default ALL0)

D	Duty (%)
00h	0.0
ffh	99.6

$$\text{Duty (\%)} = \frac{\text{R2PWM}[7:0]}{256}$$

	ADDRESS : 08h							
	D7	D6	D5	D4	D3	D2	D1	D0
register name	G2PWM[7]	G2PWM[6]	G2PWM[5]	G2PWM[4]	G2PWM[3]	G2PWM[2]	G2PWM[1]	G2PWM[0]
default	0	0	0	0	0	0	0	0

LEDG2 PWM Duty setting (Default ALL0)

D	Duty (%)
00h	0.0
ffh	99.6

$$\text{Duty (\%)} = \frac{\text{G2PWM}[7:0]}{256}$$

	ADDRESS : 09h							
	D7	D6	D5	D4	D3	D2	D1	D0
register name	B2PWM[7]	B2PWM[6]	B2PWM[5]	B2PWM[4]	B2PWM[3]	B2PWM[2]	B2PWM[1]	B2PWM[0]
default	0	0	0	0	0	0	0	0

LEDB2 PWM Duty setting (Default ALL0)

D	Duty (%)
00h	0.0
ffh	99.6

$$\text{Duty (\%)} = \frac{\text{B2PWM}[7:0]}{256}$$

LV5237JA

	ADDRESS : 0ah							
	D7	D6	D5	D4	D3	D2	D1	D0
register name	R3PWM[7]	R3PWM[6]	R3PWM[5]	R3PWM[4]	R3PWM[3]	R3PWM[2]	R3PWM[1]	R3PWM[0]
default	0	0	0	0	0	0	0	0

LEDR3 PWM Duty setting (DefaultALL0)

D	Duty (%)
00h	0.0
ffh	99.6

$$\text{Duty (\%)} = \frac{\text{R3PWM}[7:0]}{256}$$

	ADDRESS : 0bh							
	D7	D6	D5	D4	D3	D2	D1	D0
register name	G3PWM[7]	G3PWM[6]	G3PWM[5]	G3PWM[4]	G3PWM[3]	G3PWM[2]	G3PWM[1]	G3PWM[0]
default	0	0	0	0	0	0	0	0

LEDG3 PWM Duty setting (Default ALL0)

D	Duty (%)
00h	0.0
ffh	99.6

$$\text{Duty (\%)} = \frac{\text{G3PWM}[7:0]}{256}$$

	ADDRESS : 0ch							
	D7	D6	D5	D4	D3	D2	D1	D0
register name	B3PWM[7]	B3PWM[6]	B3PWM[5]	B3PWM[4]	B3PWM[3]	B3PWM[2]	B3PWM[1]	B3PWM[0]
default	0	0	0	0	0	0	0	0

LEDB3 PWM Duty setting (Default ALL0)

D	Duty (%)
00h	0.0
ffh	99.6

$$\text{Duty (\%)} = \frac{\text{B3PWM}[7:0]}{256}$$

ORDERING INFORMATION

Device	Package	Shipping (Qty / Packing)
LV5237JAZ-AH	SSOP24 (225mil) (Pb-Free / Halogen Free)	2000 / Tape & Reel

† For information on tape and reel specifications, including part orientation and tape sizes, please refer to our Tape and Reel Packaging Specifications Brochure, BRD8011/D. http://www.onsemi.com/pub_link/Collateral/BRD8011-D.PDF

ON Semiconductor and the ON Semiconductor logo are trademarks of Semiconductor Components Industries, LLC dba ON Semiconductor or its subsidiaries in the United States and/or other countries. ON Semiconductor owns the rights to a number of patents, trademarks, copyrights, trade secrets, and other intellectual property. A listing of ON Semiconductor's product/patent coverage may be accessed at www.onsemi.com/site/pdf/Patent-Marking.pdf. ON Semiconductor reserves the right to make changes without further notice to any products herein. ON Semiconductor makes no warranty, representation or guarantee regarding the suitability of its products for any particular purpose, nor does ON Semiconductor assume any liability arising out of the application or use of any product or circuit, and specifically disclaims any and all liability, including without limitation special, consequential or incidental damages. Buyer is responsible for its products and applications using ON Semiconductor products, including compliance with all laws, regulations and safety requirements or standards, regardless of any support or applications information provided by ON Semiconductor. "Typical" parameters which may be provided in ON Semiconductor data sheets and/or specifications can and do vary in different applications and actual performance may vary over time. All operating parameters, including "Typicals" must be validated for each customer application by customer's technical experts. ON Semiconductor does not convey any license under its patent rights nor the rights of others. ON Semiconductor products are not designed, intended, or authorized for use as a critical component in life support systems or any FDA Class 3 medical devices or medical devices with a same or similar classification in a foreign jurisdiction or any devices intended for implantation in the human body. Should Buyer purchase or use ON Semiconductor products for any such unintended or unauthorized application, Buyer shall indemnify and hold ON Semiconductor and its officers, employees, subsidiaries, affiliates, and distributors harmless against all claims, costs, damages, and expenses, and reasonable attorney fees arising out of, directly or indirectly, any claim of personal injury or death associated with such unintended or unauthorized use, even if such claim alleges that ON Semiconductor was negligent regarding the design or manufacture of the part. ON Semiconductor is an Equal Opportunity/Affirmative Action Employer. This literature is subject to all applicable copyright laws and is not for resale in any manner.