



Chipsmall Limited consists of a professional team with an average of over 10 year of expertise in the distribution of electronic components. Based in Hongkong, we have already established firm and mutual-benefit business relationships with customers from,Europe,America and south Asia,supplying obsolete and hard-to-find components to meet their specific needs.

With the principle of "Quality Parts,Customers Priority,Honest Operation,and Considerate Service",our business mainly focus on the distribution of electronic components. Line cards we deal with include Microchip,ALPS,ROHM,Xilinx,Pulse,ON,Everlight and Freescale. Main products comprise IC,Modules,Potentiometer,IC Socket,Relay,Connector.Our parts cover such applications as commercial,industrial, and automotives areas.

We are looking forward to setting up business relationship with you and hope to provide you with the best service and solution. Let us make a better world for our industry!



Contact us

Tel: +86-755-8981 8866 Fax: +86-755-8427 6832

Email & Skype: info@chipsmall.com Web: www.chipsmall.com

Address: A1208, Overseas Decoration Building, #122 Zhenhua RD., Futian, Shenzhen, China





ON Semiconductor®

<http://onsemi.com>

LV5685PV

Bi-CMOS LSI

System Power Supply IC for Automotive Infotainment Multiple-Output Linear Voltage Regulator

Overview

The LV5685PV is a multiple output linear regulator IC, which allows reduction of quiescent current. The LV5685PV is specifically designed to address automotive infotainment systems power supply requirements.

The LV5685PV integrates 5 linear regulator outputs, 2 high side power switches, I²C-bus communication, ACC detection, battery voltage detection, over-current limiter, overvoltage protection and thermal shut down. Supply for V_{DD} and SW33V outputs is low voltage specification, which enables drastic reduction of power dissipation compared to the existing model.

Function

- Low consumption current: 65μA (typ, only V_{DD} output is in operation)
- 5 regulator outputs
 - V_{DD} for microcontroller: output voltage: 3.3V, maximum output current: 350mA
 - For system: output voltage: 3.3/5V(set by I²C-bus), maximum output current: 450mA
 - For audio: output voltage: 5/8.5/9/11.5V(set by I²C-bus), maximum output current: 250mA
 - For illumination: output voltage: 5/8/10.5/12V(set by I²C-bus), maximum output current: 300mA
 - For CD: output voltage: 5/6/7/8V(set by I²C-bus), maximum output current: 1300mA
- 2 high side switches
 - EXT: Maximum output current: 350mA, voltage difference between input and output: 0.5V
 - ANT: Maximum output current: 300mA, voltage difference between input and output: 0.5V
- ACC detection circuit
 - detection voltage 2.7/3.2/3.6/4.2V (set by I²C-bus)
- Battery voltage detection (BDET) : V_{CC2}
 - Low voltage detection(UVDET): detection voltage 6/7/7.8/9V(set by I²C-bus)
 - Over voltage detection(OVDET): detection voltage 18V
- FLG output
 - CMOS output of ACC-detection/UVDET/OVDET/OVP
- I²C-bus communication interface
 - Each output except V_{DD} is independently enabled/disabled. ILM/CD/AUDIO/ACC/UV voltage setting.
 - Read back supported: Output voltage setting, Output over-current, FLG(ACC/UV/OVDET/OVP)
- Supply input
 - V_{6IN}: 6V for V_{DD}, system(SW33V)
 - V_{CC1}: For internal reference voltage, control circuitry
 - In case of voltage drop of V_{6IN}, V_{CC1} supplies V_{DD} output.
 - V_{CC2}: For AUDIO/ILM/CD/EXT/ANT
- Over-current protection
- Overvoltage protection(OVP):
 - V_{CC1}, V_{CC2} Typ 23V (All outputs except V_{DD} are turned off)
- Thermal shutdown: Typ 175°C

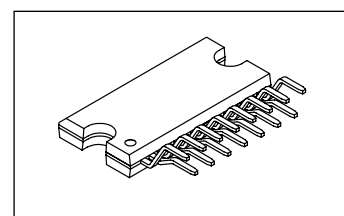

HZIP15

* I²C Bus is a trademark of Philips Corporation.

ORDERING INFORMATION

See detailed ordering and shipping information on page 29 of this data sheet.

LV5685PV

Specifications

Absolute Maximum Ratings at $T_a = 25^\circ\text{C}$

Parameter	Symbol	Conditions	Ratings	Unit
Supply voltage	Vcc max	VCC1,VCC2	36	V
	V6in max	V6IN	7	
Input voltage	Vio max	SDA,SCL,FLG	7	V
		ACCIN	36	
Allowable power dissipation	Pd max $T_a \leq 25^\circ\text{C}$	-Independent IC	1.3	W
		-Al heatsink ($50 * 50 * 1.5\text{mm}^3$) is used	5.3	
		-Size of heatsink: infinite	26	
Peak supply voltage	Vcc peak	VCC1/VCC2/ACCIN • See the test waveform below	50	V
Operating ambient temperature	Topr		-40 to +85	$^\circ\text{C}$
Storage temperature	Tstg		-55 to +150	$^\circ\text{C}$
Junction temperature	Tjmax		+150	$^\circ\text{C}$

Stresses exceeding those listed in the Maximum Ratings table may damage the device. If any of these limits are exceeded, device functionality should not be assumed, damage may occur and reliability may be affected.

- Waveform of surge test (VCC1,VCC2,ACCIN)

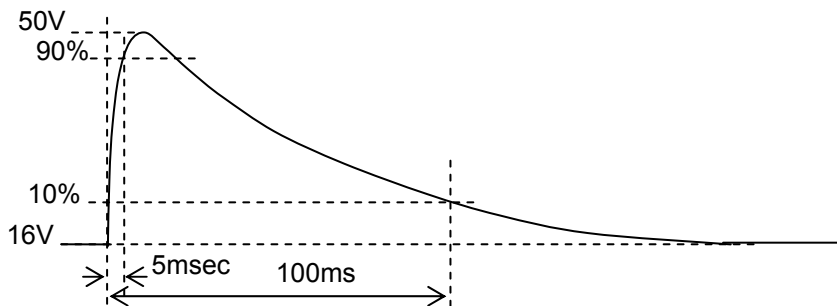

- Allowable power dissipation derating curve

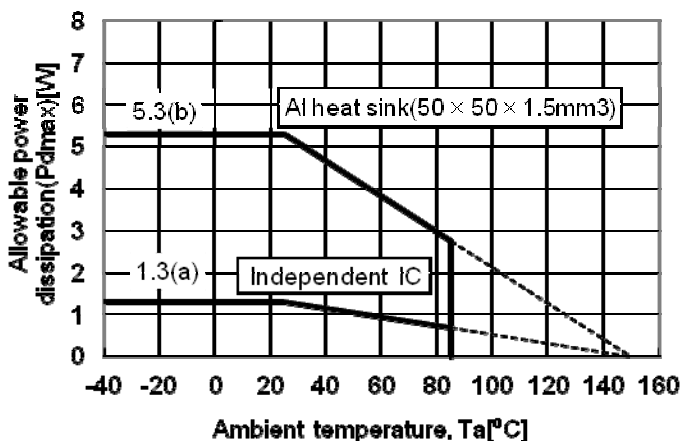

(a) Independent IC
 (b) Aluminum heat-sink ($50 \times 50 \times 1.5\text{mm}^3$)
 Heat-sink tightening condition
 tightening torque: $39\text{N}\cdot\text{cm}$,
 with silicone grease

LV5685PV

Recommended Operating Conditions at Ta = 25°C

■VCC1

Parameter	Conditions	Ratings	Unit
Operating supply voltage1	VDD output	7 to 16	V

■VCC2

Parameter	Conditions	Ratings	Unit
Operating supply voltage2	ILM(10.5V) output	12.5 to 16	V
	ILM(8V) output	10 to 16	
Operating supply voltage3	AUDIO(8.5V) output	9.5 to 16	V
Operating supply voltage4	CD(8V) output(Io=1.3A)	10.5 to 16	V
	CD(8V) output(Io≤ 1A)	10 to 16	
Operating supply voltage5	EXT output, ANT output	7.5 to 16	V

■V6IN

Parameter	Conditions	Ratings	Unit
Operating supply voltage6	VDD output	5.1 to 6.5	V
	SW33V(3.3V) output	5.1 to 6.5	V
	SW33V(5V) output	5.7 to 6.5	V

Functional operation above the stresses listed in the Recommended Operating Ranges is not implied. Extended exposure to stresses beyond the Recommended Operating Ranges limits may affect device reliability.

• "Maximum Rating" and "Recommended operating range"

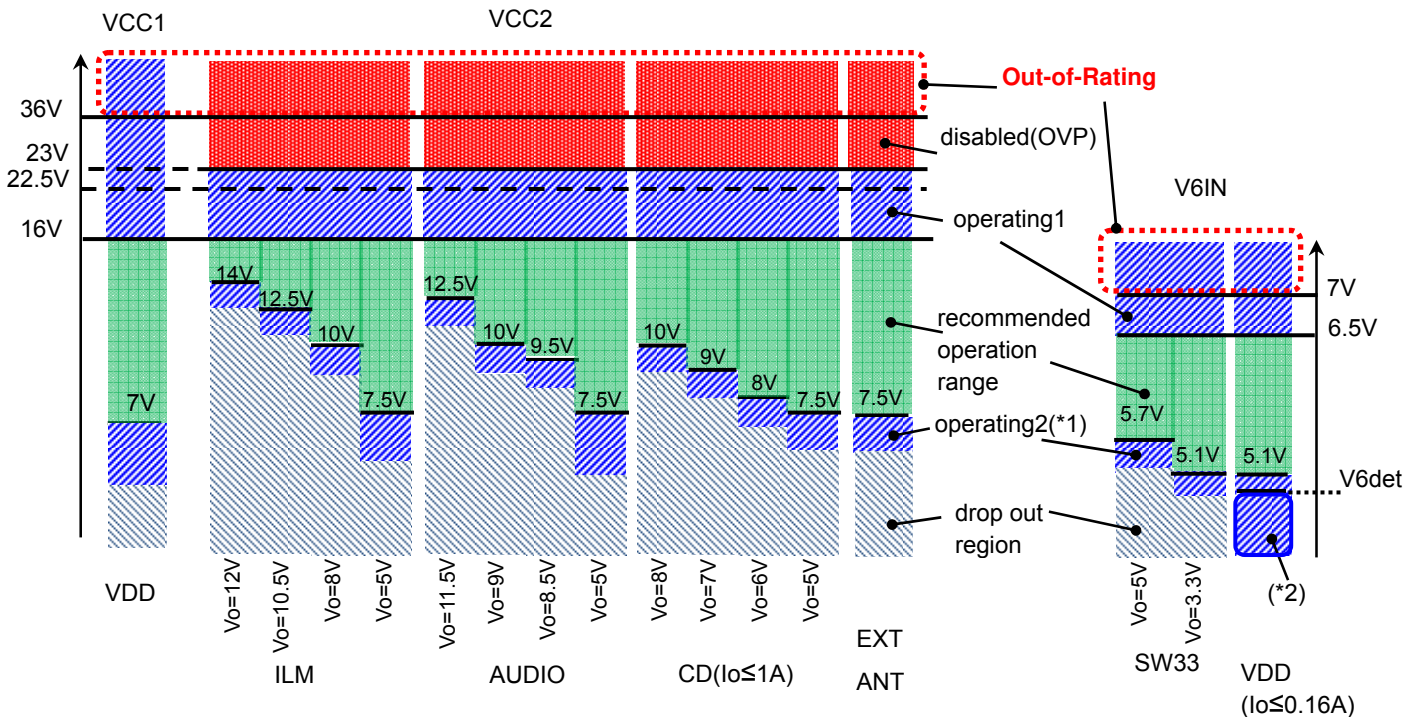

(*1) Each lower limit value is determined by "Output voltage"- "Dropout voltage".

(*2) Operating in VCC1→VDD current path

LV5685PV

Electrical Characteristics at Ta = 25°C(*1), VCC1=VCC2=14.4V, V6IN=6V

Parameter	Symbol	Conditions	Min	Typ	Max	Unit
Quiescent current	I _{cc}	VDD w/out load, V6IN=0V, ACCIN=0V I ² C register Gr0/Gr1/Gr2=00h		65	100	μA
VDD output (3.3V)						
Output voltage	V _{o1}	I _{o1} =200mA	3.13	3.3	3.47	V
Output current	I _{o1}	V _{o1} ≥ 3.1V	350			mA
Line regulation	ΔV _{oLN1}	5.7V<V6IN<6.5V, I _{o1} =200mA or V6IN=0V, 7.5V<VCC1<16V, I _{o1} =200mA		30	90	mV
Load regulation	ΔV _{oLD1}	1 mA<I _{o1} <200mA		70	150	mV
Dropout voltage1	V _{DROP1}	I _{o1} =200mA, V6IN=0V (applicable to VCC1→VDD)		0.5	1.0	V
Dropout voltage2	V _{DROP12}	I _{o1} =200mA (applicable to V6IN→VDD, design target)		1.1	1.3	V
Ripple rejection(*2)	R _{REJ1}	f=120Hz, V6IN or VCC1=0.5Vpp I _{o1} =200mA	40	50		dB
V6IN detection voltage	V6det	V6IN rising, VCC1→V6IN switch(*3)	4.7	4.85	5.0	V
V6IN detection hysteresis	V6hys			100		mV
(*3): Please use V6IN≥5.7V in the case of I _o >160mA, or output voltage may be dropped when V6IN voltage is decreased to approximately "V6IN detection voltage".						
SW33V output (3.3V/5V) ; SW33_EN=1						
Output voltage1	V _{o21}	I _{o2} =200mA, SW_V=0	3.13	3.3	3.47	V
Output voltage2	V _{o22}	I _{o2} =200mA, SW_V=1	4.75	5.0	5.25	V
Output current	I _{o2}	V _{o21} ≥3.1V, V _{o22} ≥4.7V	450			mA
Line regulation	ΔV _{oLN2}	5.7V<V6IN<6.5V, I _{o2} =200mA		30	90	mV
Load regulation	ΔV _{oLD2}	1 mA<I _{o2} <200mA		70	150	mV
Dropout voltage	V _{DROP2}	I _{o2} =200mA		0.25	0.5	V
Ripple rejection(*2)	R _{REJ2}	f=120Hz, V6IN or VCC1=0.5Vpp I _{o2} =200mA	40	50		dB
ILM output (5-12V); ILM_EN=1						
Output voltage1	V _{o31}	I _{o3} =200mA, ILM_V[1:0]=00	4.75	5.0	5.25	V
Output voltage2	V _{o32}	I _{o3} =200mA, ILM_V[1:0]=01	7.6	8.0	8.4	V
Output voltage3	V _{o33}	I _{o3} =200mA, ILM_V[1:0]=10	9.97	10.5	11.03	V
Output voltage4	V _{o34}	I _{o3} =200mA, ILM_V[1:0]=11	11.4	12	12.6	V
Output current	I _{o3}		300			mA
Line regulation	ΔV _{oLN3}	V _o +2V<VCC2<16V, I _{o3} =200mA		30	90	mV
Load regulation	ΔV _{oLD3}	1 mA<I _{o3} <200mA		70	150	mV
Dropout voltage1	V _{DROP3}	I _{o3} =200mA		0.6	1.05	V
Dropout voltage2	V _{DROP3'}	I _{o3} =100mA		0.3	0.53	V
Ripple rejection(*2)	R _{REJ3}	f=120Hz, I _{o3} =200mA	40	50		dB

Continued on next page

LV5685PV

Continued from preceding page.

Parameter	Symbol	Conditions	Min	Typ	Max	Unit
CD output (5-8V); CD_EN=1						
Output voltage1	Vo41	Io4=1000 mA, CD_V[1:0]=00	4.75	5.0	5.25	V
Output voltage2	Vo42	Io4=1000 mA, CD_V[1:0]=01	5.7	6.0	6.3	V
Output voltage3	Vo43	Io4=1000 mA, CD_V[1:0]=10	6.65	7.0	7.35	V
Output voltage4	Vo44	Io4=1000 mA, CD_V[1:0]=11	7.6	8.0	8.4	V
Output current	Io4	Vo41≥4.7V, V44≥7.6V	1300			mA
Line regulation	ΔV_{oLN4}	Vo+2V<Vcc2<16V, Io4=1000mA		50	100	mV
Load regulation	ΔV_{oLD4}	10mA<Io4<1000mA		100	200	mV
Dropout voltage1	V _{DROP4}	Io4=1000mA		0.9	1.5	V
Dropout voltage2	V _{DROP4'}	Io4=500mA		0.45	0.75	V
Ripple rejection(*2)	R _{REJ4}	f=120Hz, Io4=1000mA	40	50		dB
AUDIO output (5-11.5V); AUDIO_EN=1						
Output voltage1	Vo51	Io5=150mA, AUD_V[1:0]=00	4.75	5.0	5.25	V
Output voltage2	Vo52	Io5=150mA, AUD_V[1:0]=01	8.13	8.5	8.87	V
Output voltage3	Vo53	Io5=150mA, AUD_V[1:0]=10	8.55	9.0	9.45	V
Output voltage4	Vo54	Io5=150mA, AUD_V[1:0]=11	10.9	11.5	12.08	V
Output current	Io5		250			mA
Line regulation	ΔV_{oLN5}	Vo+1V<VCC2<16V, Io5=150mA		30	90	mV
Load regulation	ΔV_{oLD5}	1mA<Io5<150mA		70	150	mV
Dropout voltage	V _{DROP5}	Io5=150mA		0.25	0.45	V
Ripple rejection(*2)	R _{REJ5}	f=120Hz, Io5=150mA	40	50		dB
EXT_HS-SW; EXT_EN=1						
Output voltage	Vo6	Io6=350mA	Vcc2-1.0	Vcc2-0.5		V
Output current	Io6	Vo6≥VCC2-1.0	350			mA
ANT_HS-SW; ANT_EN=1						
Output voltage	Vo7	Io7=300mA	Vcc2-1.0	Vcc2-0.5		V
Output current	Io7	Vo7≥VCC2-1.0	300			mA
ACC detection						
Detection voltage1	Vacc1	ACC_V[1:0]=00, ACCIN falling	2.62	2.7	2.78	V
Detection voltage 2	Vacc2	ACC_V[1:0]=01, ACCIN falling	3.1	3.2	3.3	V
Detection voltage 3	Vacc3	ACC_V[1:0]=10, ACCIN falling	3.49	3.6	3.71	V
Detection voltage 4	Vacc4	ACC_V[1:0]=11, ACCIN falling	4.07	4.2	4.33	V
Release voltage1	Vaccr1	ACC_V[1:0]=00, ACCIN rising	2.81	2.9	2.99	V
Release voltage 2	Vaccr2	ACC_V[1:0]=01, ACCIN rising	3.3	3.4	3.5	V
Release voltage 3	Vaccr3	ACC_V[1:0]=10, ACCIN rising	3.68	3.8	3.92	V
Release voltage 4	Vaccr4	ACC_V[1:0]=11, ACCIN rising	4.26	4.4	4.54	V
Threshold hysteresis	Vachs			0.2		V

Continued on next page

LV5685PV

Continued from preceding page.

Parameter	Symbol	Conditions	Min	Typ	Max	Unit
Under-Voltage detection(UVDET)						
detection voltage1	Vuv1	VCC2 falling, UVD_V[1:0]=00	5.82	6.0	6.18	V
detection voltage2	Vuv2	VCC2 falling, UVD_V[1:0]=01	6.79	7.0	7.21	V
detection voltage3	Vuv3	VCC2 falling, UVD_V[1:0]=10	7.56	7.8	8.04	V
detection voltage4	Vuv4	VCC2 falling, UVD_V[1:0]=11	8.73	9.0	9.27	V
release voltage1	Vuvr1	VCC2 rising, UVD_V[1:0]=00	6.06	6.25	6.43	V
release voltage2	Vuvr2	VCC2 rising, UVD_V[1:0]=01	7.13	7.35	7.57	V
release voltage3	Vuvr3	VCC2 rising, UVD_V[1:0]=10	8.05	8.3	8.55	V
release voltage4	Vuvr4	VCC2 rising, UVD_V[1:0]=11	9.40	9.7	9.99	V
detection hysteresis1	Vuvhs1	UVD_V[1:0]=00		0.25		V
detection hysteresis2	Vuvhs2	UVD_V[1:0]=01		0.35		V
detection hysteresis3	Vuvhs3	UVD_V[1:0]=10		0.5		V
detection hysteresis4	Vuvhs4	UVD_V[1:0]=11		0.7		V
Over-Voltage detection(OVDET)						
detection voltage	Vovd	VCC2 rising	17	18	19	V
detection hysteresis	Vodhys			0.5		V
Over-Voltage protection(OVP)						
detection voltage	Vovp	VCC1/VCC2 rising, output disabled		23		V
detection hysteresis	Vovhys			0.5		V
V6IN Shutdown detection(V6SDN)						
detection voltage	V6sdn	V6IN falling, output disabled	0.6	1.02	1.4	V
detection hysteresis	V6sdhs			80		mV
FLG output						
FLG "H" voltage	VflgH	Isource=1mA		VDD-0.3	VDD	V
FLG "L" voltage	VflgL	Isink=1mA		0.3	0.4	V
I²C-BUS I/F; SCL,SDA						
Input "L" voltage	V _{IL}		0		0.4	V
Input "H" voltage	V _{IH}		2.8	3.3	5.5	V
SDA "L" voltage	V _{OL}	Isink=1mA, ACK or data read		0.3	0.4	V

(*1) All the specification is defined based on the tests performed under the conditions where T_j and T_a(=25°C) are almost equal. These tests were performed with pulse load to minimize the increase of junction temperature (T_j).

(*2) guaranteed by design

Product parametric performance is indicated in the Electrical Characteristics for the listed test conditions, unless otherwise noted. Product performance may not be indicated by the Electrical Characteristics if operated under different conditions.

LV5685PV

TYPICAL CHARACTERISTICS

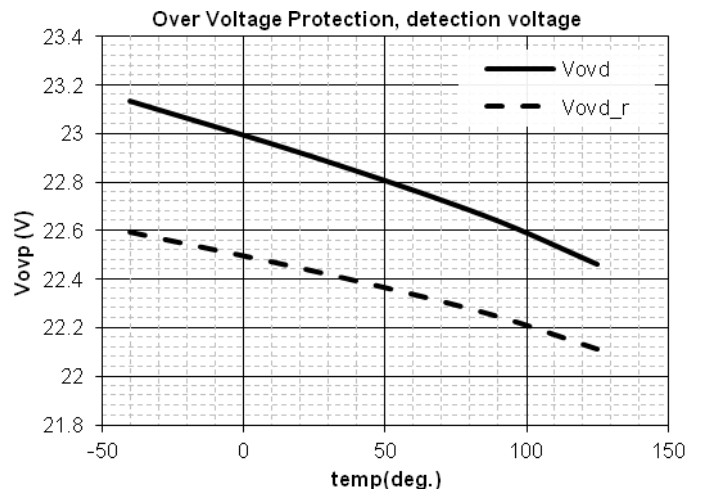
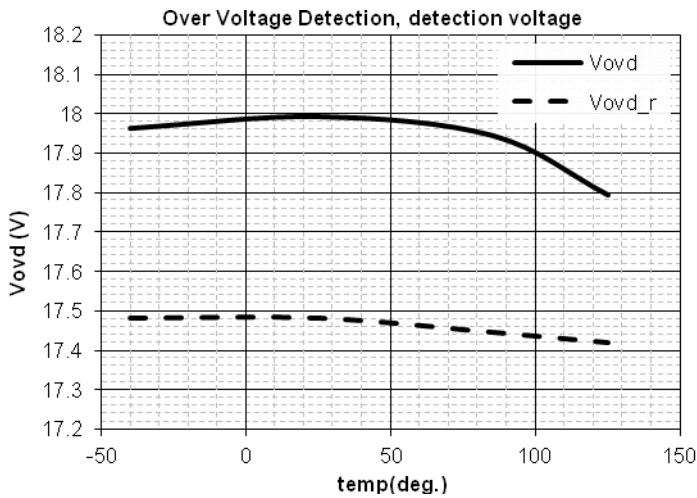
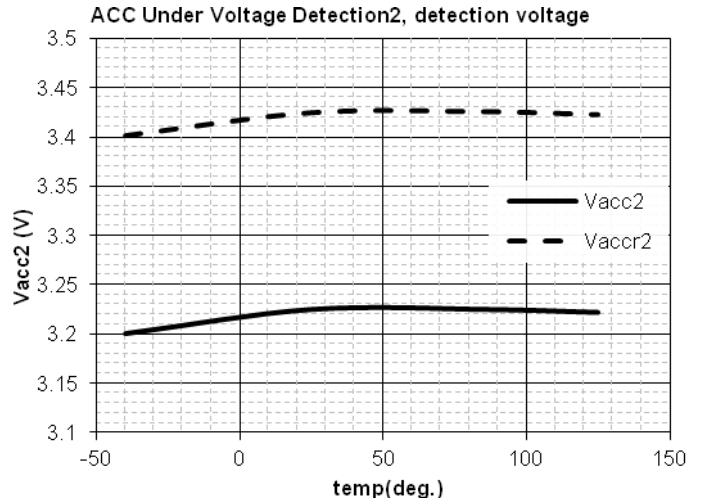
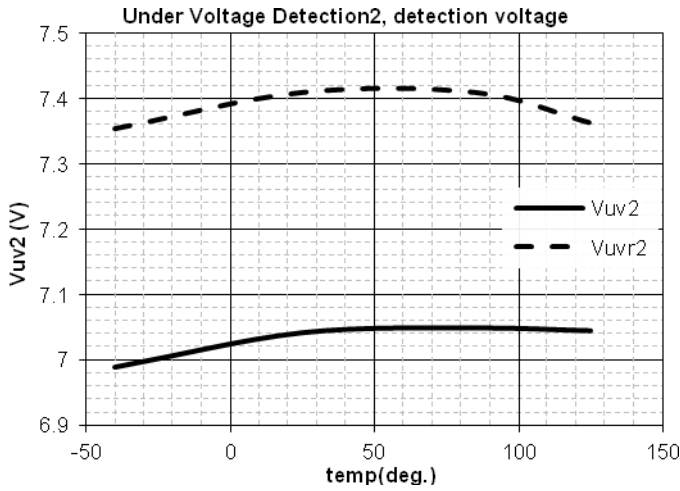
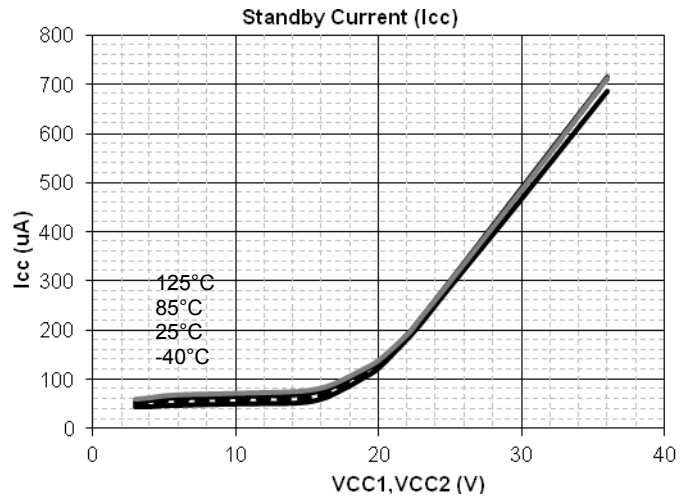
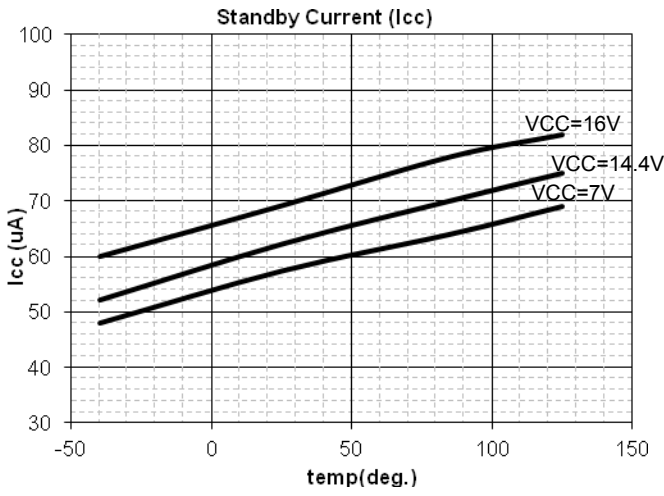

LV5685PV

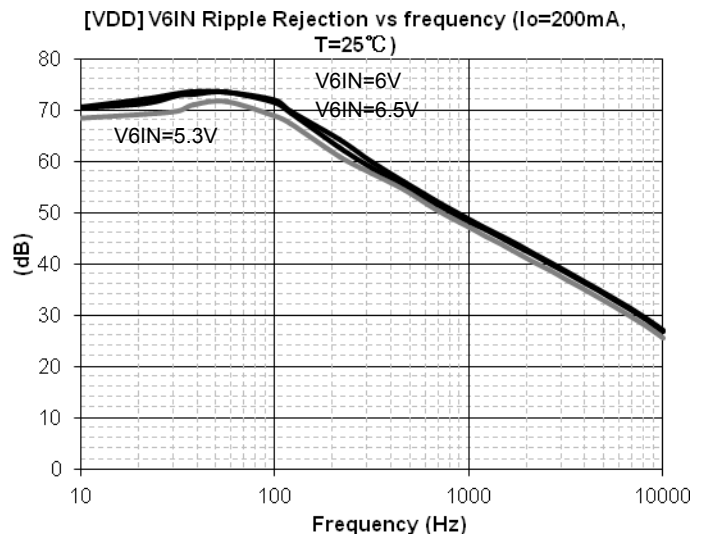
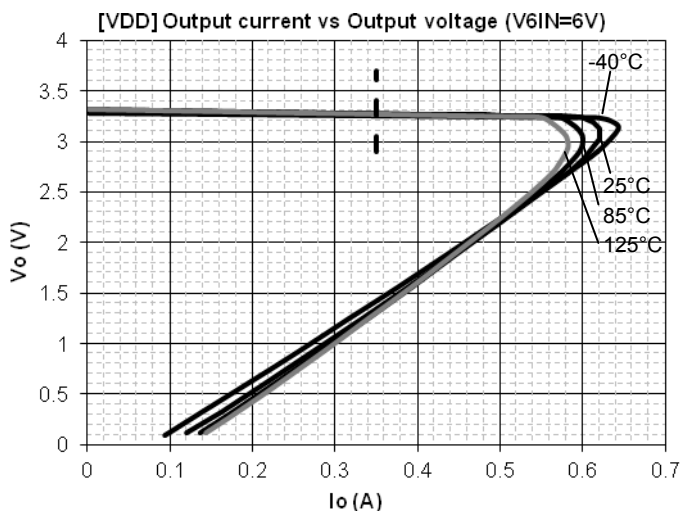
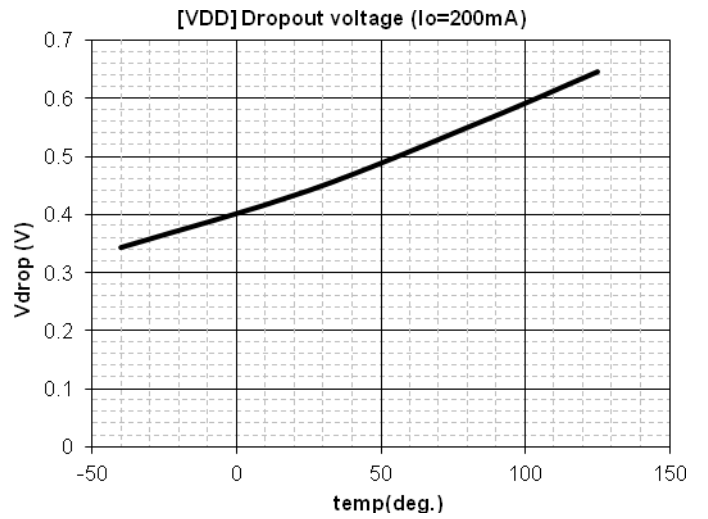
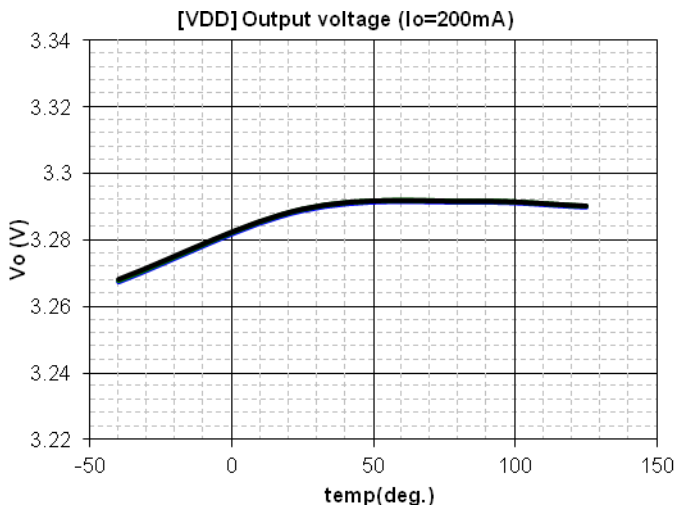
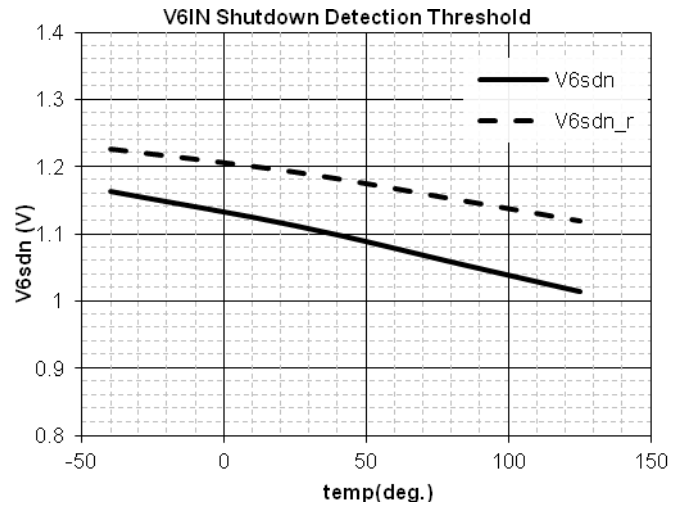
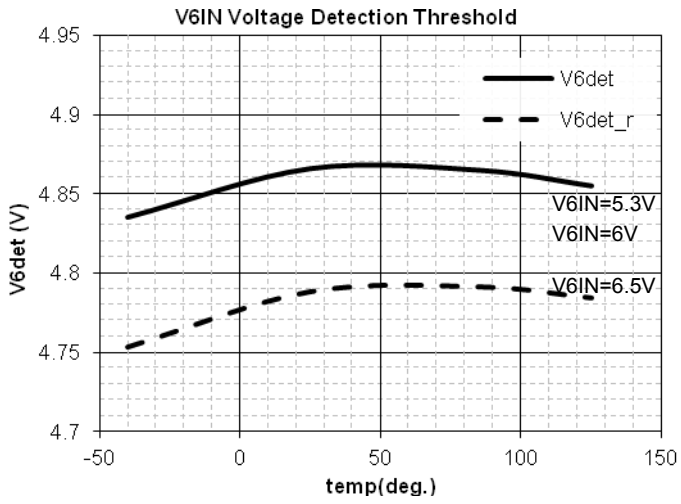

LV5685PV

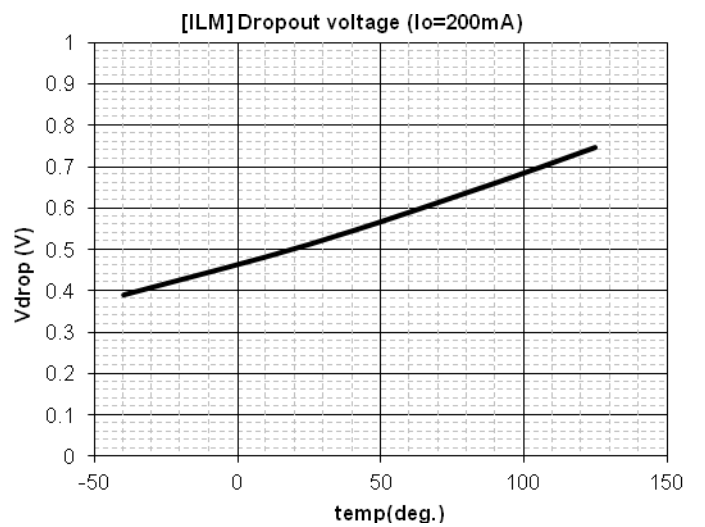
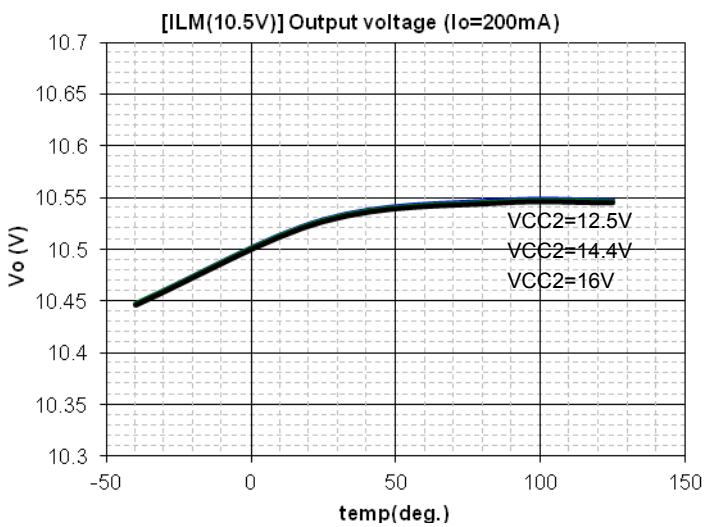
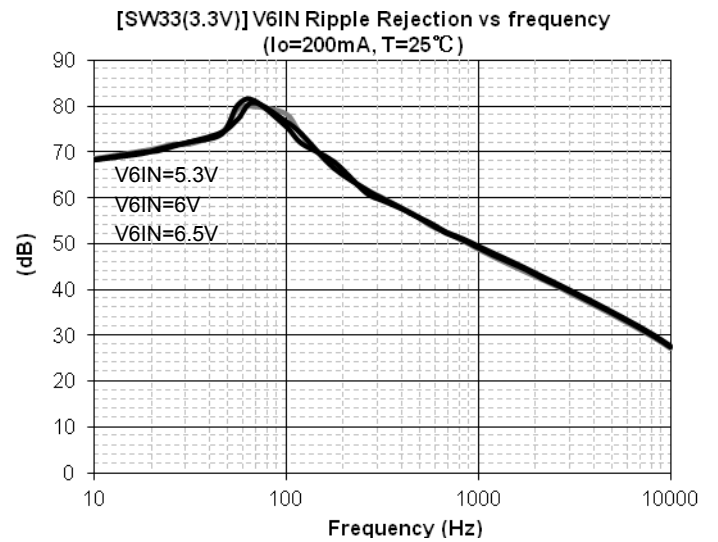
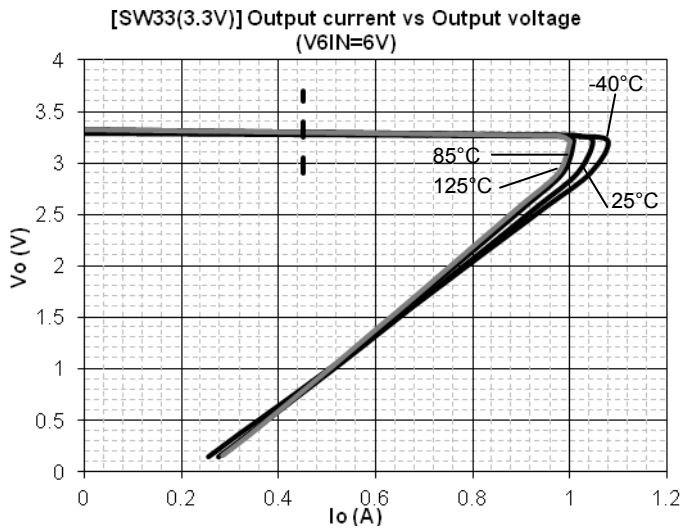
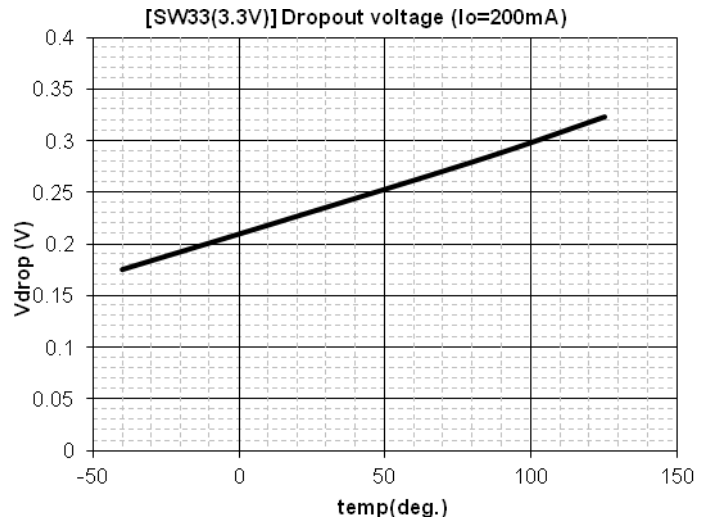
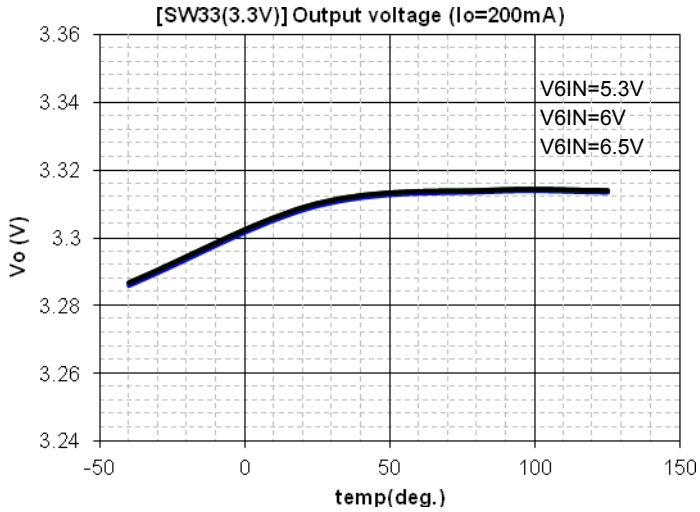

LV5685PV

[ILM(10.5V)] Output current vs Output voltage
(VCC2=14.4V)

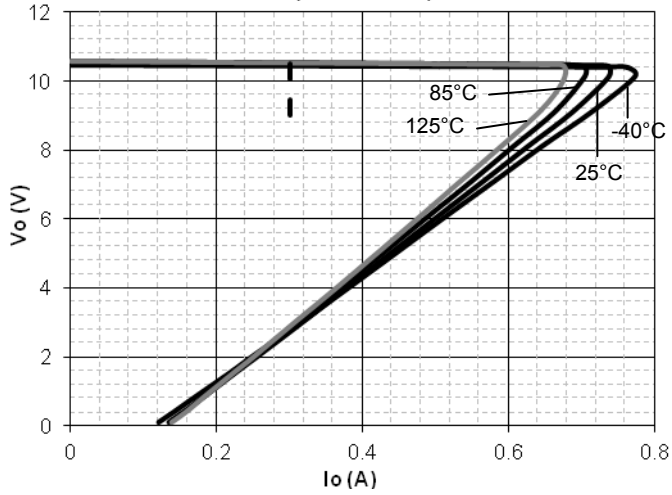

[ILM(10.5V)] Ripple Rejection vs frequency
(Io=200mA, T=25°C)

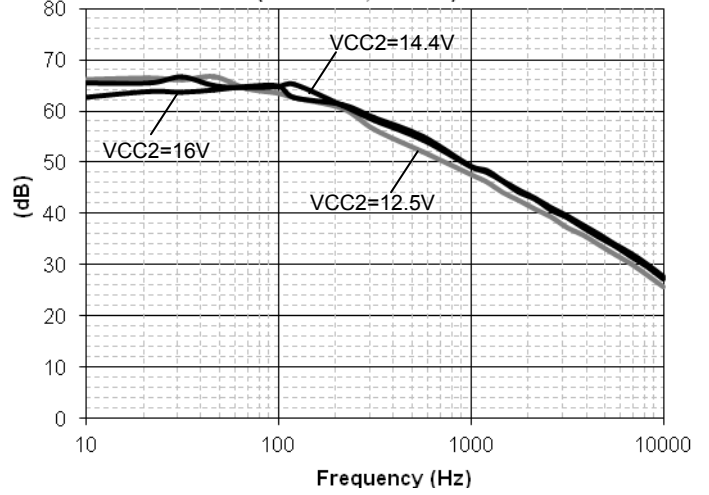

[CD(8V)] Output voltage (Io=1A)

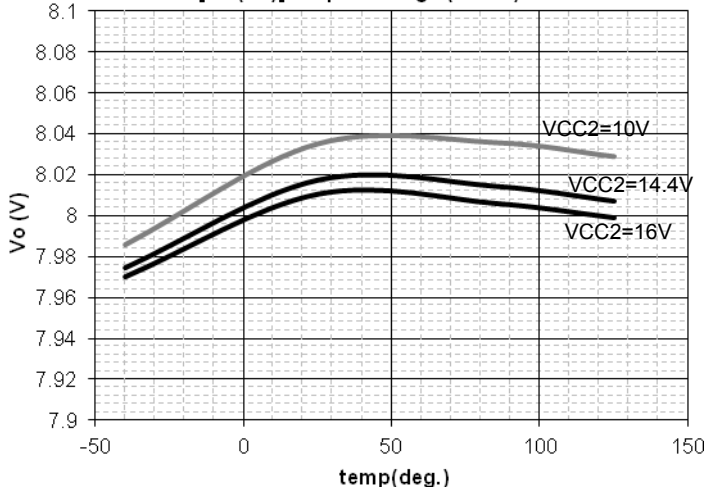

[CD(8V)] Dropout voltage (Io=1A)

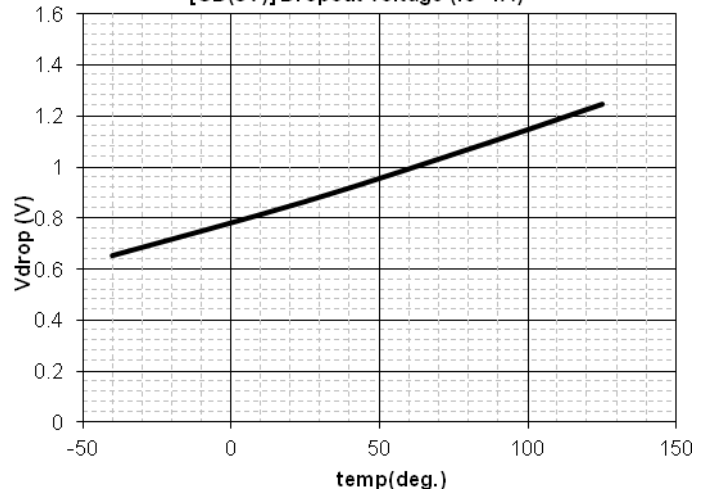

[CD(8V)] Output current vs Output voltage
(VCC2=14.4V)

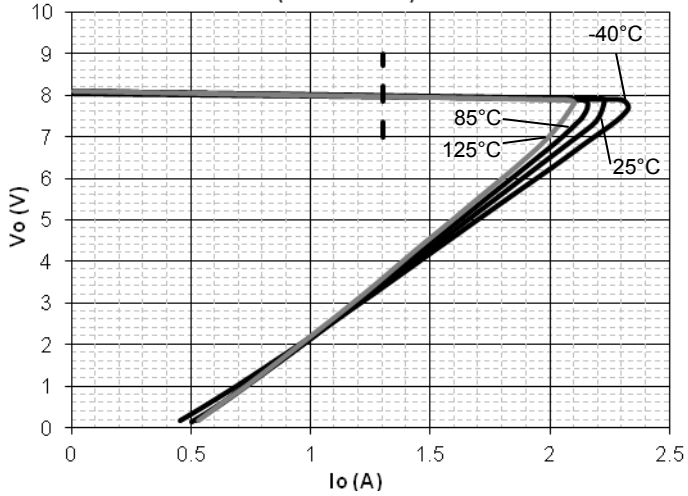

[CD(8V)] Ripple Rejection vs frequency (Io=1000mA, T=25°C)

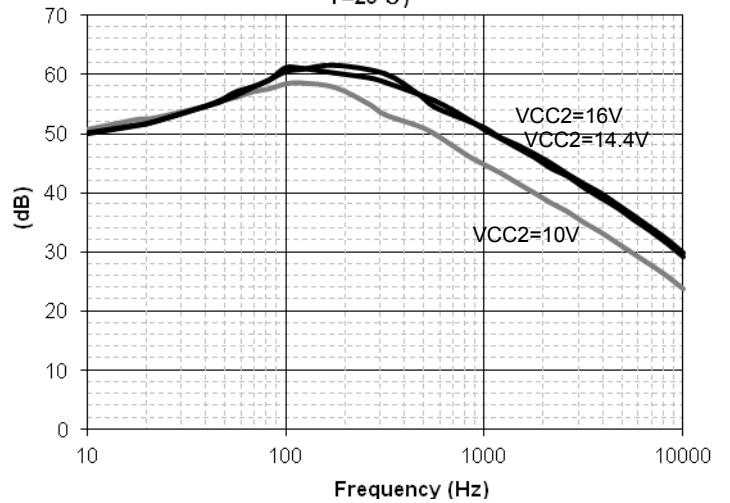

LV5685PV

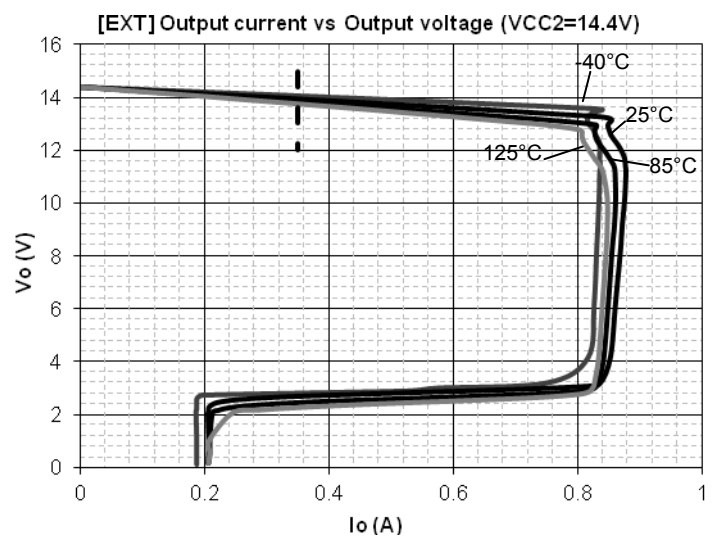
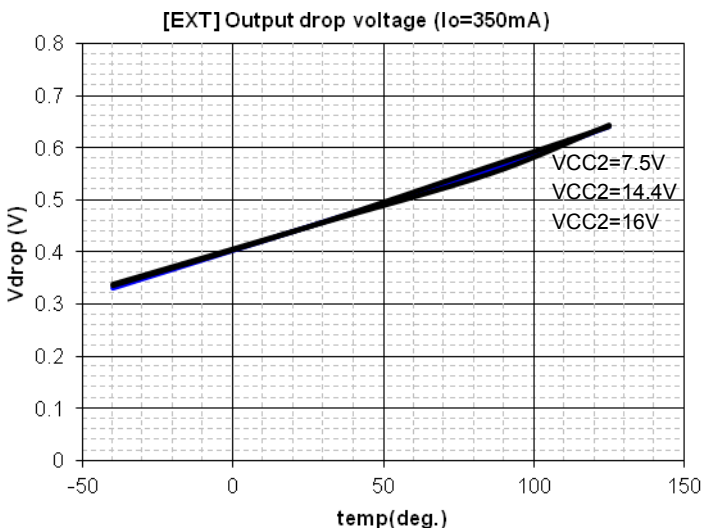
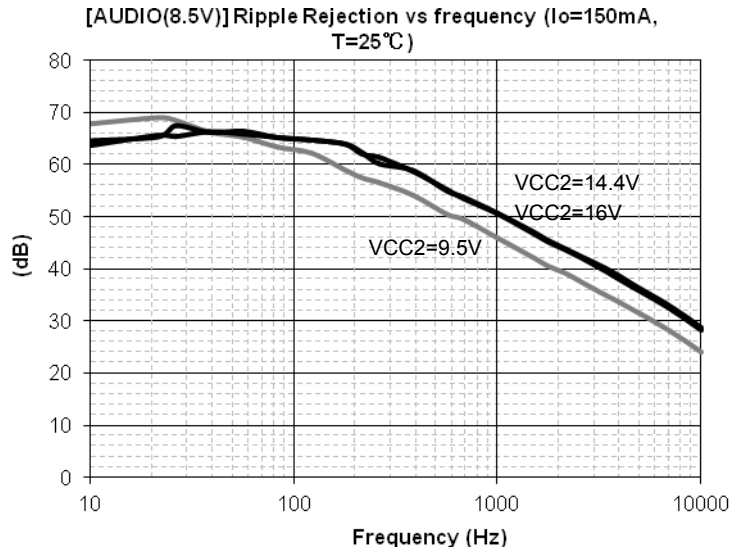
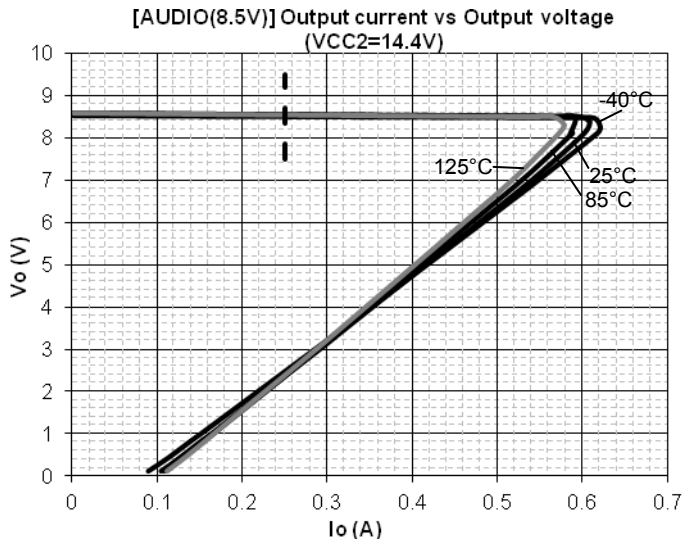
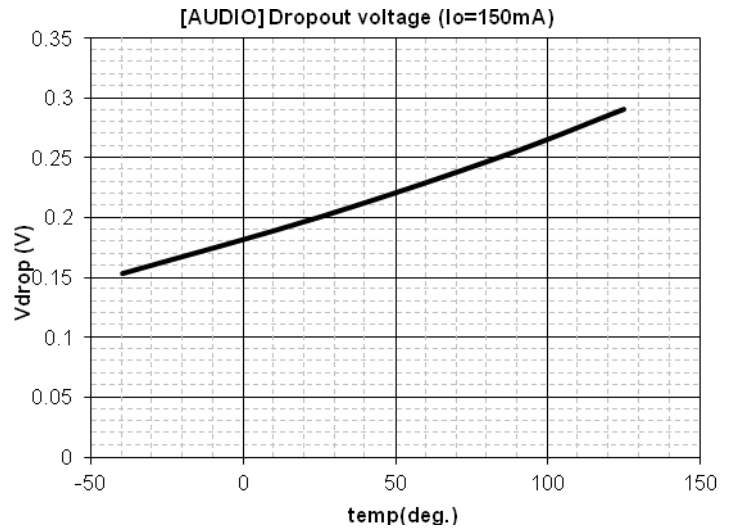
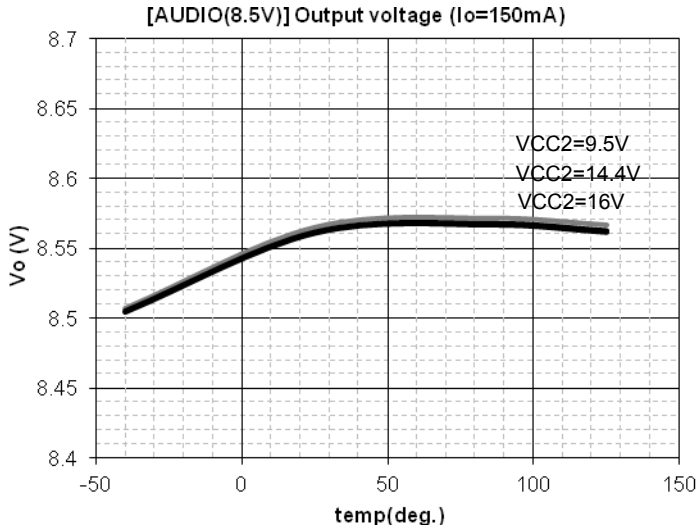

LV5685PV

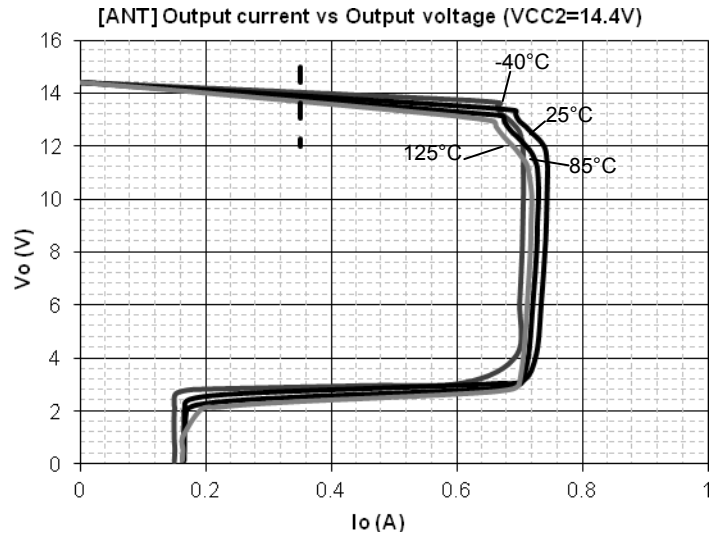
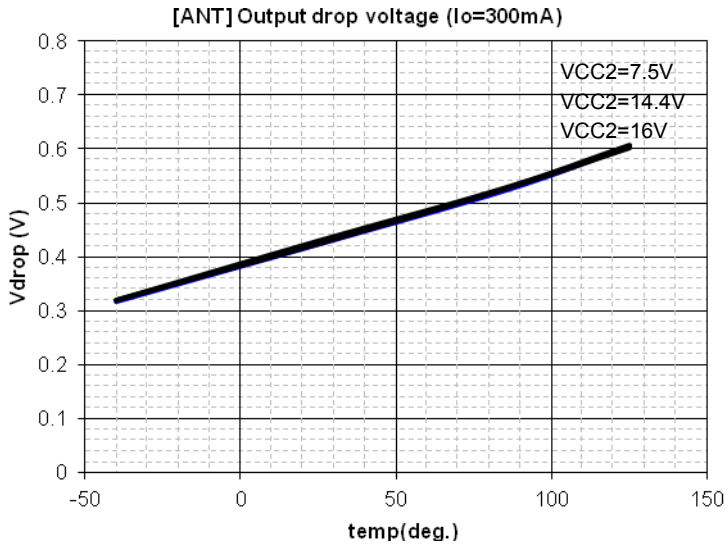

LV5685PV

I²C-bus Interface timing

Parameter	Symbol	min	typ	max	unit
SCL clock frequency	fSCL	0		400	kHz
START condition hold time	tHD;STA	0.6			us
SCL "L" pulse-width	tLOW	1.3			us
SCL "H" pulse-width	tHIGH	0.6			us
DATA hold time	tHD;DAT	0			us
DATA setup time	tSU;DAT	0.1			us
SDA/SCL rise time	tr			0.3	us
SDA/SCL fall time	tf			0.3	us
STOP condition setup time	tSU;STO	0.6			us
Bus free time between STOP and START condition	tBUF	1.3			us
Bus line load capacitance	Cb			400	pF

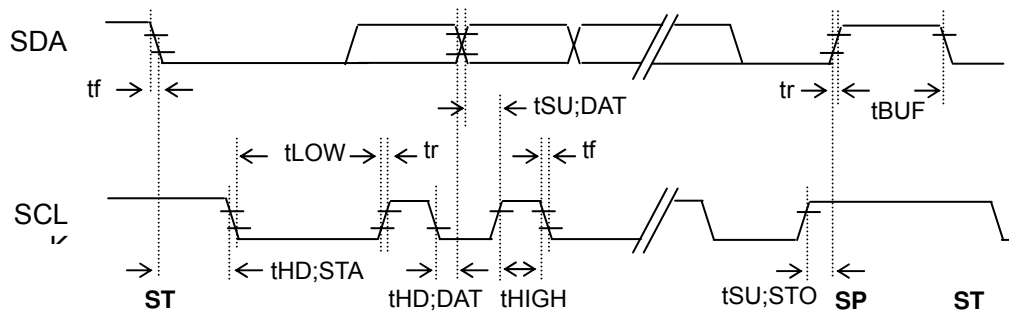

I²C bus interface format (MSB first)

This part is I²C controlled power supply, using 2 wires of SCL,SDA.

The communication protocol comprises start-condition, device-address, sub-address, data and stop-condition.

Every 8bits are followed by ACK bit, and the receiver device pulls down SDA line during ACK period.

This part doesn't accept sub-address auto increment format. (Single data byte write per a communication.)

The protocol in Read-mode comprises start-condition, device-address, data1, data2 and stop-condition.

(Note)The I²C-bus communication may be unstable when VDD voltage is not stable or out of specification range, since I²C-BUS circuitry is supplied by VDD.

Write mode

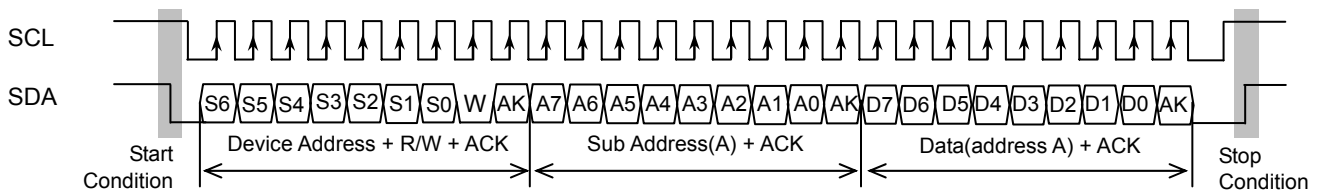

Read mode

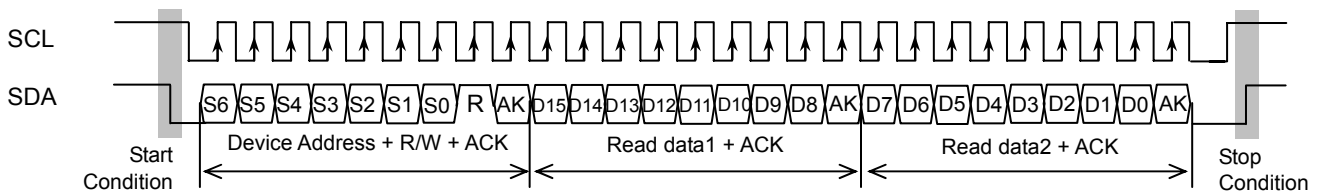

• Device address

S6	S5	S4	S3	S2	S1	S0	R/W
0	0	0	1	0	0	0	1/0

• Register map

Write

	D7	D6	D5	D4	D3	D2	D1	D0	init
PM	ILM_EN	CD_EN	AUDIO_EN	SW33_EN	EXT_EN	ANT_EN			00000000
VCTL	ILM_V1	ILM_V0	CD_V1	CD_V0	AUD_V1	AUD_V0	SW_V		00000000
DET	ACC_V1	ACC_V0	UVD_V1	UVD_V0	FLGMD1	FLGMD0			00000000

Read

	D15	D14	D13	D12	D11	D10	D9	D8	init
VCTL	ILM_V1	ILM_V0	CD_V1	CD_V0	AUD_V1	AUD_V0	SW_V	V6DET	00000000

	D7	D6	D5	D4	D3	D2	D1	D0	init
FLG	ACCUV	UV	OV	OVP	V6SDN	OC	0	0	00000000

LV5685PV

Write Register explanation

ADR	bit	Name	init	Description
00h	7	ILM_EN	0	ILM output enable 1: ON 0: OFF
	6	CD_EN	0	CD output enable 1: ON 0: OFF
	5	AUDIO_EN	0	AUDIO output enable 1: ON 0: OFF
	4	SW33_EN	0	SW33 output enable 1: ON 0: OFF
	3	EXT_EN	0	EXT output enable 1: ON 0: OFF
	2	ANT_EN	0	ANT output enable 1: ON 0: OFF
	1		0	
	0		0	

ADR	bit	Name	init	Description
01h	[7:6]	ILM_V[1:0]	00	ILM output voltage(*) 11: 12V 10: 10.5V 01: 8V 00: 5V
	[5:4]	CD_V[1:0]	00	CD output voltage(*) 11: 8V 10: 7V 01: 6V 00: 5V
	[3:2]	AUD_V[1:0]	00	AUDIO output voltage(*) 11: 11.5V 10: 9V 01: 8.5V 00: 5V
	1	SW_V	0	SW33V output voltage(*) 1: 5V 0: 3.3V
	0		0	

(*) "Output voltage setting" is only valid when corresponding output is set disabled(xxx_EN=0). It is ignored when the output is set enabled(xxx_EN=1).

ADR	bit	Name	init	Description
02h	[7:6]	ACC_V[1:0]	00	ACC detection voltage 11: 4.2V 10: 3.6V 01: 3.2V 00: 2.7V
	[5:4]	UVD_V[1:0]	00	UVDET detection voltage 11: 9V 10: 7.8V 01: 7V 00: 6V
	[3:2]	FLGMD[1:0]	00	FLG output mode 11/10: BDET only 01: ACC only, 00: ACC/BDET
	1		0	
	0		0	

Read Register explanation

ADR	bit	Name	init	Description
	[15:14]	ILM_V[1:0]	00	ILM output voltage 11: 12V 10: 10.5V 01: 8V 00: 5V
	[13:12]	CD_V[1:0]	00	CD output voltage 11: 8V 10: 7V 01: 6V 00: 5V
	[11:10]	AUD_V[1:0]	00	AUDIO output voltage 11: 11.5V 10: 9V 01: 8.5V 00: 5V
	9	SW_V	0	SW33V output voltage 1: 5V 0: 3.3V
	8	V6DET	0	V6INDET / Supply for VDD 1: V6IN 0: VCC1
	7	ACCUV	0	ACC detection 1: Under voltage 0: Normal
	6	UV	0	Under voltage detection 1: Under voltage 0: Normal
	5	OV	0	Over voltage detection 1: Over Voltage 0: Normal
	4	OVP	0	Over voltage protection 1: Over Voltage Protection 0: Normal
	3	V6SDN	0	V6IN shutdown detection 1: V6IN shutdown 0: V6IN applied
	2	OC	0	Output Over Current 1: Over current 0: Normal
	1		0	
	0		0	

Package Dimensions

unit : mm

HZIP15
CASE 945AB
ISSUE A

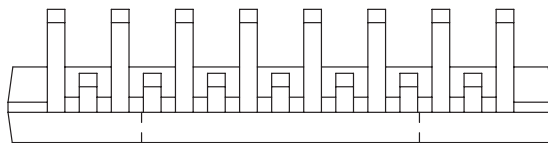
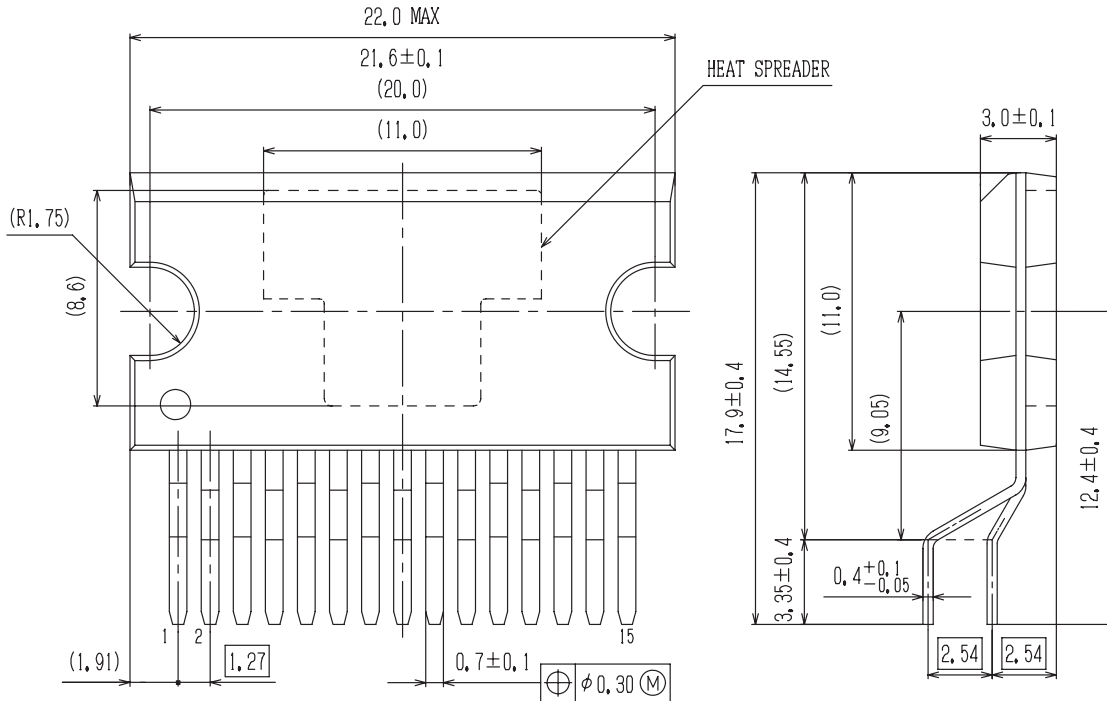

GENERIC MARKING DIAGRAM*

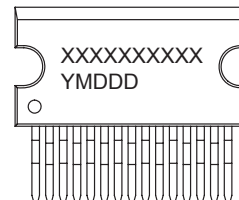

XXXXX = Specific Device Code
Y = Year
M = Month
DDD = Additional Traceability Data

*This information is generic. Please refer to device data sheet for actual part marking. Pb-Free indicator, "G" or microdot "▪", may or may not be present.

SOLDERING FOOTPRINT*

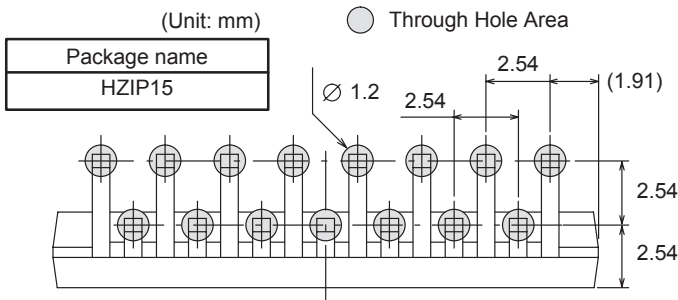

NOTE: The measurements are not to guarantee but for reference only.

*For additional information on our Pb-Free strategy and soldering details, please download the ON Semiconductor Soldering and Mounting Techniques Reference Manual, SOLDERRM/D.

LV5685PV

Application Circuit Example

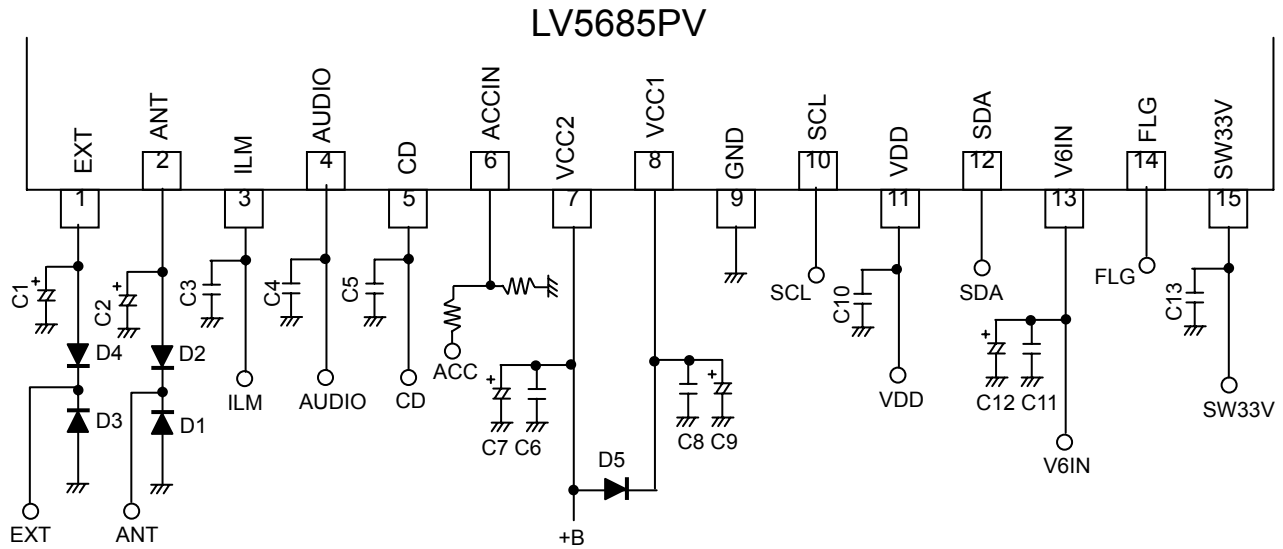

■Peripheral parts

Part name	Description	Recommended value	Note
C1,C2	Capacitor for EXT/ANT output stabilization	greater than 2.2 μ F	
C3,C4,C5, C10,C13	output stabilization capacitor	greater than 10 μ F(*1)	
C7,C9,C12	Capacitor for bypass power supply	C7: greater than 100 μ F C9,C12: greater than 47 μ F	Make sure to implement close to VCC and GND.
C6,C8,C11	Capacitor for oscillation protector	greater than 0.22 μ F	
D1,D2,D3,D4	Internal device protection diode	ON Semiconductor SB1003M3	
D5	Reverse current protection diode	ON Semiconductor SB1003M3	

(*1) Make sure that output capacitors are greater than 10 μ F and meets the condition of ESR=0.001 to 10 Ω , in which voltage/temperature dependence and unit differences are taken into consideration. Moreover, in case of electrolytic capacitor, high-frequency characteristics should be sufficiently good.

LV5685PV

Block Diagram

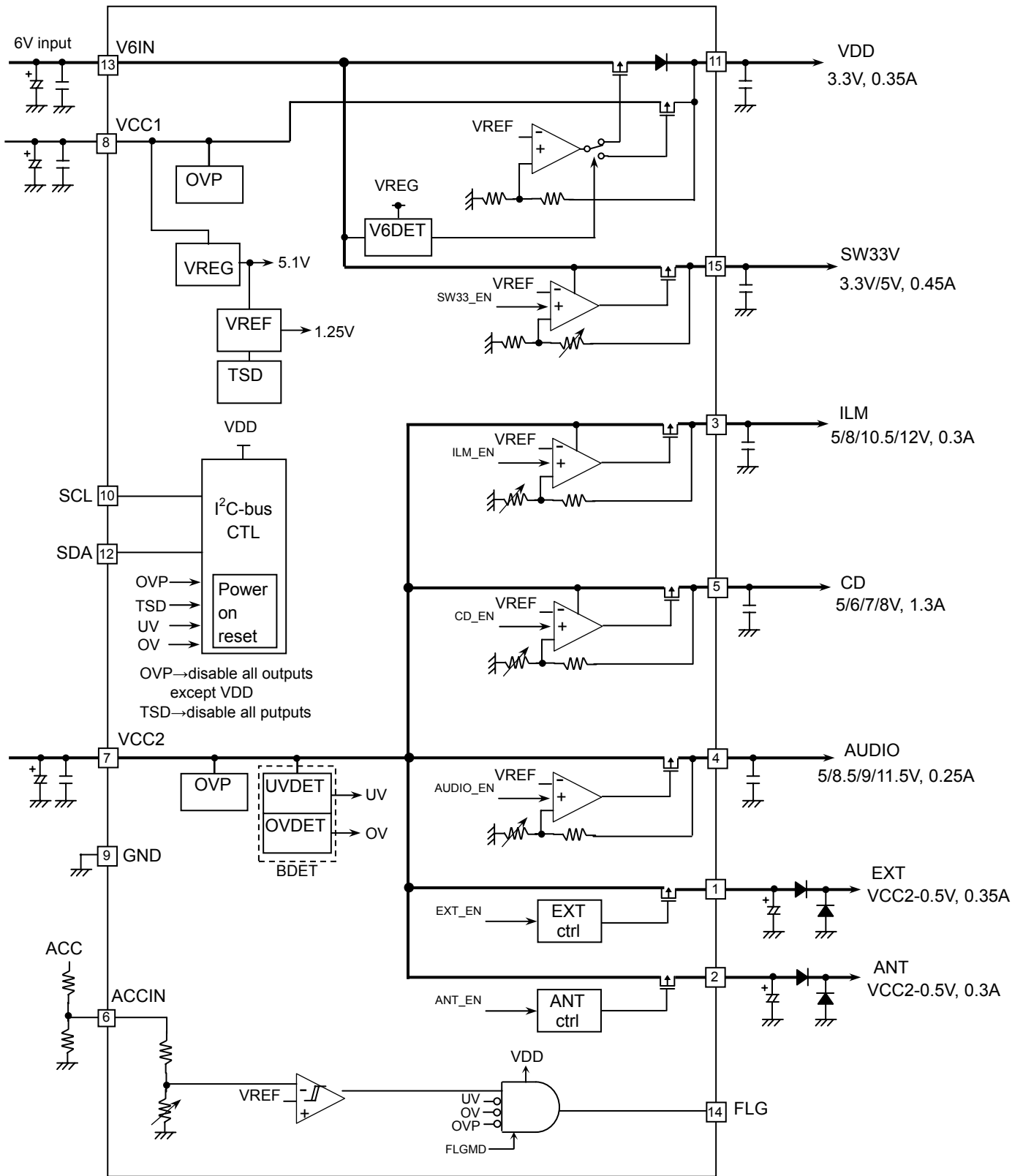

LV5685PV

■ Timing Chart

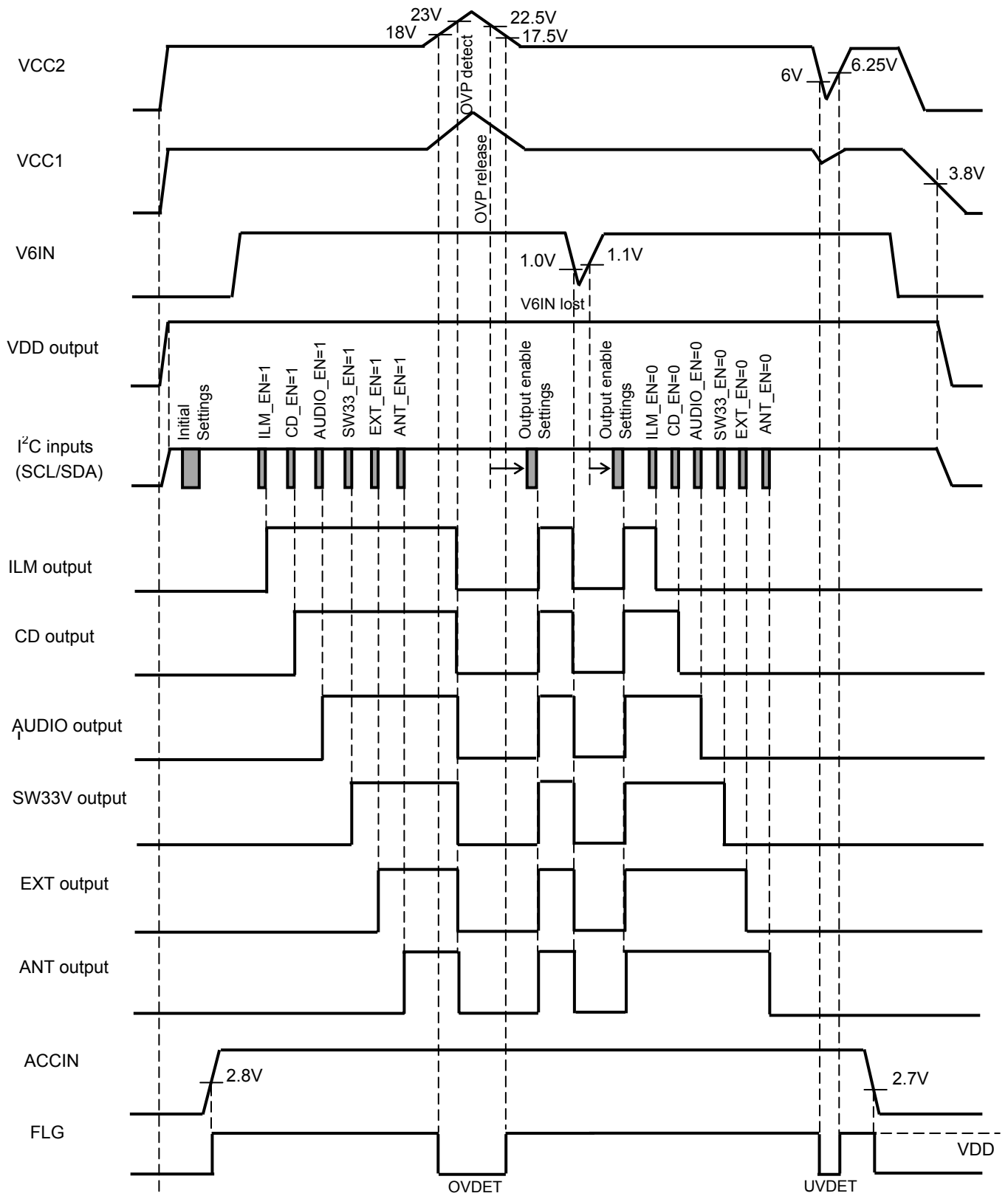

Note: The above values are obtained when typ. All the voltage setting are default values

Functional Description

[Standby mode]

When VCC1 is applied, internal control circuitry is automatically reset and goes into Stand-by mode.

In Stand-by mode, following functions are active.

VDD(3.3V) output

I²C-bus communication (except for "PM" register)

Over voltage protection(OVP)/UVDET/OVDET/ACC detection/FLG output

Thermal shutdown(TSD)

[VCC1/VCC2/V6IN]

VCC1 supplies VDD and common circuitry such as reference voltage, internal control circuitry. So VCC1 input is necessary for any operation of this device.

VCC2 is the supply for AUDIO/ILM/CD/EXT/ANT outputs.

LV5685PV has the tolerance value of 50V against VCC1/2 and ACCIN peak surge voltage, but for more safety set design, adding power clamp, such as power zener diode, on battery connected line is recommended in order to absorb applied surge.

LV5685PV has no protection against battery reverse connection, so adding Schottky diode is recommended to prevent a negative voltage.

V6IN is the supply for SW33V. V6IN also supplies VDD when V6IN voltage exceeds 4.85V(typ).

When VCC2 and V6IN is applied, ILM/CD/AUDIO/SW33/EXT/ANT output can be set enable via I²C-bus.

When V6IN is lower than 1.1V(typ)(max:1.5V), output enable command above can't be accepted.

[Controls]

The functions of LV5685PV can be controlled via I2C bus. See "I2C bus interface format" term for details.

[Linear Regulators]

VDD output

When VCC1 is applied, VDD output is active regardless of control states. When V6IN is applied and the voltage exceeds 4.85V(typ), supply for VDD output switches from VCC1 to V6IN in order to reduce power dissipation.

See "VDD regulator circuit description" term for detail.

SW33V/CD/AUDIO/ILM output

These outputs are individually enabled or disabled via I²C-bus.

The voltage of each output can be selected via I²C-bus. These commands must be set prior to enabling corresponding output. If you change the voltage for these outputs, be sure to do it after the output is set disabled. In order to avoid unwanted output voltage change, each "output voltage setting" is accepted only when corresponding output is set disabled(XXX_EN=0). The "output voltage setting" is ignored if the output is set enabled(XXX_EN=1).

Output voltage setting can be referred by reading via I²C-bus(VCTL register). It is strongly recommended to read and check VCTL register value just before setting enable the output in order to avoid unwanted output voltage change even in case if communication error were to happen and incorrect voltage setting were written to the device.

Each regulator output limits output current if the output gets over-loaded condition. The limit current decreases as the output voltage gets lower, in order to reduce the stress applied to the device.

LV5685PV

All regulators in LV5685PV are low dropout outputs, because the output stage of all regulators is P-channel LDMOS.

When you select output capacitors for linear regulators, you should consider three main characteristics: startup delay, transient response and loop stability. The capacitor values and type should be based on cost, availability, size and temperature constraints. Tantalum, Aluminum electrolytic, Film, or Ceramic capacitors are all acceptable solutions. However, attention must be paid to ESR constraints. The aluminum electrolytic capacitor is the least expensive solution, but if the circuit operates at low temperatures (-25 to -40°C), both the value and ESR of the capacitor will vary considerably. The capacitor manufacturer's datasheet usually provides this information.

[High-side switches]

ANT and EXT are high-side power switches connected to VCC2. These outputs are individually enabled or disabled via I²C-bus.

Each high-side switch limits output current if the output gets over-loaded condition. The limit current becomes lower value, if the output voltage gets lower than 2.5V(typ) in order to reduce the stress applied to the device. If these outputs are connected to inductive load or loads which have different ground potential, protection diodes (D1-4) are necessary to protect the device from negative voltage.

[Current Limiting]

When the each output becomes in over load condition, the device limits the output current.

All outputs are also protected against short circuit by fold back current limiter.

If one of each output except VDD is in over-current condition, OC bit of FLG register is set 1, which can be read via I²C-bus.

[FLG output]

FLG is the CMOS level logic output which indicates the combination of several detectors' results.

FLG output is set "High"(VDD voltage), if all the following conditions are satisfied.

	Conditions	FLGMD[1:0]		
		00	01	10 or11
ACC	ACC input voltage>ACC detection threshold	✓	✓	ignored
BDET	VCC2 voltage>UVDET threshold	✓	ignored	✓
	VCC2 voltage<OVDET threshold	✓	ignored	✓
OVP	VCC1<OVP threshold and VCC2<OVP threshold	✓	ignored	✓
TSD	Die temperature<175°C(typ)	✓	✓	✓
	VDD output current< I _{omax}	✓	✓	✓

Note: I²C-bus "FLG" register bits is active regardless of FLGMD[1:0] setting.

[Detections]

Under voltage detection (UVDET)

If the VCC2 voltage gets lower than set value (UVD_V[1:0]), Under-Voltage is detected and the UV bit of FLG register is set 1, which can be read via I²C-bus. FLG pin keeps "Low" during UVDET condition except for at FLGMD[1:0]=01. Each output status keeps the same condition even if UV is detected.

Over voltage detection (OVDET)

If the VCC2 voltage exceeds 18V(typ), Over-Voltage is detected and the OV bit of FLG register is set 1, which can be read via I²C-bus. FLG pin keeps "Low" during OVDET condition except for at FLGMD[1:0]=01. Each output status keeps the same condition even if OV is detected.

ACC Under voltage detection

If the ACCIN voltage gets lower than set value (ACC_V[1:0]), the ACCUV bit of FLG register is set 1, which can be read via I²C-bus. FLG pin keeps "Low" during ACCUV is detected if FLGMD[1:0] is 00 or 01.

Each output status keeps the same condition even if ACCUV is detected.

Over voltage protection (OVP)

If the voltage of VCC1 or VCC2 exceed 23V(typ), OVP is detected and the OVP bit of FLG register is set 1, which can be read via I²C-bus. And all the outputs except VDD are automatically turned off. When the voltage of VCC1 and VCC2 get lower than 22.5V(typ), OVP detection is released. But output voltages are not automatically restored, because once OVP is detected, PM register of I²C-bus is reset.

FLG pin keeps "Low" during OVP condition except for at FLGMD[1:0]=01.

V6IN shutdown detection

If the V6IN voltage decreases lower than 1.0V(typ), V6IN-shutdown is detected and the V6SDN bit of FLG register is set 1, which can be read via I²C-bus. And all the outputs except VDD are automatically turned off. Output voltages are not automatically activated if V6IN voltage is restored, because once V6IN shutdown is detected, PM register of I²C-bus is reset.

Thermal Shutdown

To protect the device from overheating, a thermal shutdown circuitry is included. If the junction temperature reaches approximately 175°C(typ), all outputs are turned off regardless of control state. After the junction temperature drops below 145°C(typ), VDD output is automatically restored and I²C-bus control becomes available.

The thermal shutdown circuit does not guarantee the protection of the final product because it operates out of maximum rating (exceeding T_{jmax}=150°C).

VDD regulator circuit description

- Supply current switching

VDD output is always in operation except under thermal shut down (TSD) condition. There are 2 supply inputs (VCC1/V6IN) for this output. VCC1 is capable of high-voltage input such as car-battery. V6IN is a low voltage input and can be supplied from external DC/DC converter in order to decrease power dissipation of the device. Supply current path from VCC1 or V6IN is automatically switched depending on V6IN voltage. If V6IN voltage exceeds 4.85V(typ), V6IN supplies VDD output. Output ripple may be occurred when supply switching. This ripple can be improved by using proper output capacitor. Select appropriate capacitor suitable for your requirement.

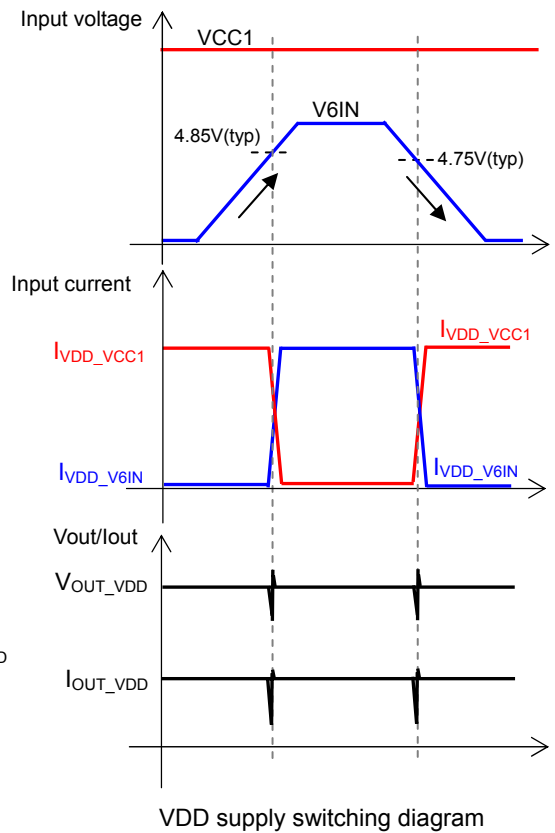
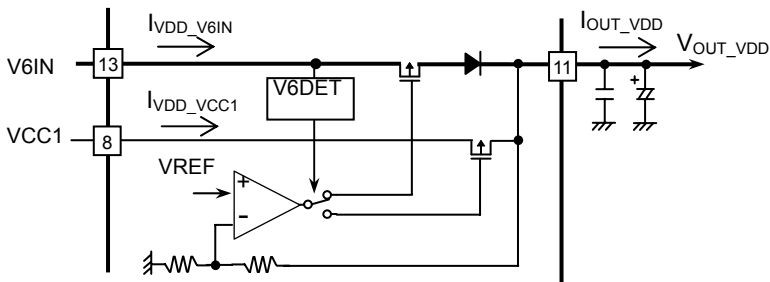

- Reverse current protection for battery voltage black-out

There is no diode inside to prevent reverse current from VDD to VCC1. You have to add external circuit to hold VDD voltage under battery voltage black-out. There is a parasitic diode from VDD to VCC1, so insert a diode between VCC2 and VCC1 as shown figure below.

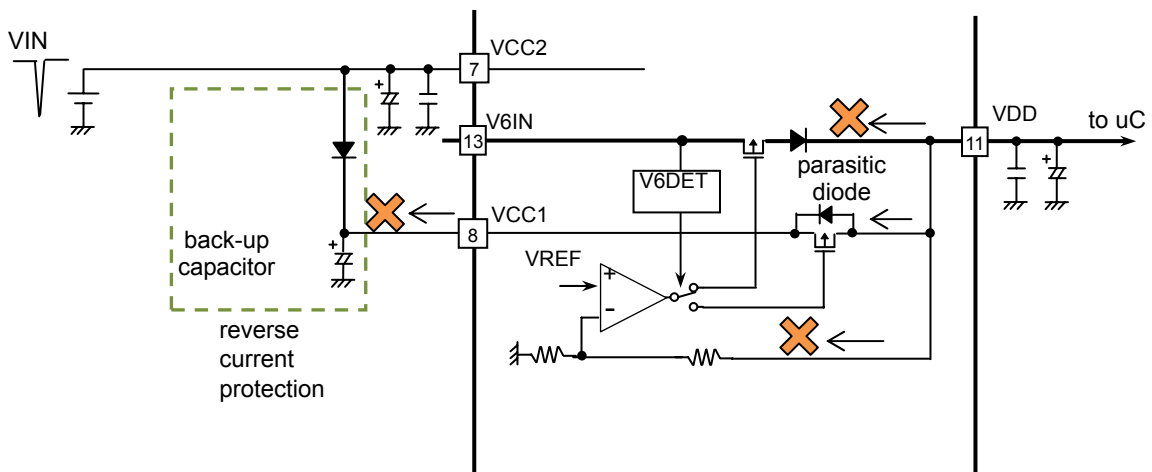

LV5685PV

■Pin description

Pin #	Pin name	Function	Equivalent circuit
1	EXT	EXT output VCC2-0.5V/350mA	
2	ANT	ANT output VCC2-0.5V/300mA	
3	ILM	ILM output 5V~12V	
4	AUDIO	AUDIO output 5V~11.5V	

Continued on next page.

LV5685PV

Continued from preceding page.

Pin #	Pin name	Function	Equivalent circuit
5	CD	CD output 5V~8V/1.3A	
6	ACCIN	ACC detection input	
7	VCC2	Supply terminal	
8	VCC1	Supply terminal	
9	GND	GND	
13	V6IN	Supply terminal	
10	SCL	I ² C-bus clock input	
11	VDD	VDD output 3.3V/0.35A	

Continued on next page