



Chipsmall Limited consists of a professional team with an average of over 10 year of expertise in the distribution of electronic components. Based in Hongkong, we have already established firm and mutual-benefit business relationships with customers from,Europe,America and south Asia,supplying obsolete and hard-to-find components to meet their specific needs.

With the principle of “Quality Parts,Customers Priority,Honest Operation,and Considerate Service”,our business mainly focus on the distribution of electronic components. Line cards we deal with include Microchip,ALPS,ROHM,Xilinx,Pulse,ON,Everlight and Freescale. Main products comprise IC,Modules,Potentiometer,IC Socket,Relay,Connector.Our parts cover such applications as commercial,industrial, and automotives areas.

We are looking forward to setting up business relationship with you and hope to provide you with the best service and solution. Let us make a better world for our industry!



Contact us

Tel: +86-755-8981 8866 Fax: +86-755-8427 6832

Email & Skype: info@chipsmall.com Web: www.chipsmall.com

Address: A1208, Overseas Decoration Building, #122 Zhenhua RD., Futian, Shenzhen, China



JC030-Series Power Modules: 18 Vdc to 36 Vdc Inputs; 2 Vdc to 15 Vdc Outputs; 13 W to 30 W



The JC030-Series Power Modules use advanced, surface-mount technology and deliver high-quality, compact, dc-dc conversion at an economical price.

Applications

- Distributed power architectures
- Telecommunication equipment

Options

- Choice of remote on/off configurations
- Short pins: 2.79 mm ± 0.25 mm (0.110 in. ± 0.010 in.)
- Heat sinks available for extended operation

Description

The JC030-Series Power Modules are dc-dc converters that operate over an input voltage range of 18 Vdc to 36 Vdc and provide precisely regulated 2 V, 5 V, 12 V, and 15 V outputs. The outputs are isolated from the inputs, allowing versatile polarity configurations and grounding connections. The modules have maximum power ratings of 30 W at a typical full-load efficiency of 81%.

The power modules feature remote on/off, output sense (both negative and positive leads), and output voltage adjustment, which allows output voltage adjustment from 60% to 110% (80% to 110% for the JC030A-M and JC030D-M) of the nominal output voltage. For disk-drive applications, the JC030B-M Power Module provides a motor-start surge current of 3 A.

The modules are PC-board mountable and encapsulated in metal cases. The modules are rated to full load at 100 °C case temperature with no external filtering.

Features

- Small size: 61.0 mm x 57.9 mm x 12.7 mm (2.40 in. x 2.28 in. x 0.50 in.)
- Low output noise
- Constant frequency
- Industry-standard pinout
- Metal case
- 2:1 input voltage range
- High efficiency: 81% typical
- Overcurrent protection
- Remote on/off
- Remote sense
- Adjustable output voltage
- Output overvoltage protection
- Case ground pin
- *UL** 1950 Recognized, *CSA*† C22.2 No. 950-95 Certified, *VDE*‡ 0805 (EN60950, IEC950) Licensed
- Within FCC Class A radiated limits

* *UL* is a registered trademark of Underwriters Laboratories, Inc.

† *CSA* is a registered trademark of Canadian Standards Association.

‡ *VDE* is a trademark of Verband Deutscher Elektrotechniker e.V.

Absolute Maximum Ratings

Stresses in excess of the absolute maximum ratings can cause permanent damage to the device. These are absolute stress ratings only. Functional operation of the device is not implied at these or any other conditions in excess of those given in the operations sections of the data sheet. Exposure to absolute maximum ratings for extended periods can adversely affect device reliability.

Parameter	Symbol	Min	Max	Unit
Input Voltage (continuous)	V_I	—	50	Vdc
Operating Case Temperature (See Thermal Considerations section.)	T_C	-40	100	°C
Storage Temperature	T_{stg}	-40	110	°C
I/O Isolation Voltage: dc	—	—	500	Vdc
Transient (1 min)	—	—	850	Vdc

Electrical Specifications

Unless otherwise indicated, specifications apply over all operating input voltage, resistive load, and temperature conditions.

Table 1. Input Specifications

Parameter	Symbol	Min	Typ	Max	Unit
Operating Input Voltage	V_I	18	24	36	Vdc
Maximum Input Current ($V_I = 0$ V to 6 V; $I_O = I_{O, max}$. See Figure 1.)	$I_{I, max}$	—	—	3.0	A
Inrush Transient	i^2t	—	—	0.2	A ² s
Input Reflected-ripple Current, Peak-to-peak (5 Hz to 20 MHz, 12 μ H source impedance; $T_C = 25$ °C; see Figure 19 and Design Considerations section.)	I_r	—	30	—	mAp-p
Input Ripple Rejection (120 Hz)	—	—	60	—	dB

Fusing Considerations

CAUTION: This power module is not internally fused. An input line fuse must always be used.

This encapsulated power module can be used in a wide variety of applications, ranging from simple stand-alone operation to an integrated part of a sophisticated power architecture. To preserve maximum flexibility, internal fusing is not included; however, to achieve maximum safety and system protection, always use an input line fuse. The safety agencies require a normal-blow fuse with a maximum rating of 5 A (see Safety Considerations section). Based on the information provided in this data sheet on inrush energy and maximum dc input current, the same type of fuse with a lower rating can be used. Refer to the fuse manufacturer's data for further information.

Electrical Specifications (continued)

Table 2. Output Specifications

Parameter	Device or Suffix	Symbol	Min	Typ	Max	Unit
Output Voltage Set Point ($V_I = 24\text{ V}$; $I_O = I_{O, \text{max}}$; $T_C = 25\text{ }^\circ\text{C}$)	JC030D-M	$V_{O, \text{set}}$	1.96	2.0	2.04	Vdc
	JC030A-M	$V_{O, \text{set}}$	4.95	5.0	5.05	Vdc
	JC030B-M	$V_{O, \text{set}}$	11.82	12.0	12.18	Vdc
	JC030C-M	$V_{O, \text{set}}$	14.77	15.0	15.23	Vdc
Output Voltage (Over all operating input voltage, resistive load, and temperature conditions until end of life. See Figure 21.)	JC030D-M	V_O	1.90	—	2.10	Vdc
	JC030A-M	V_O	4.85	—	5.15	Vdc
	JC030B-M	V_O	11.64	—	12.36	Vdc
	JC030C-M	V_O	14.55	—	15.45	Vdc
Output Regulation: Line ($V_I = 18\text{ V to } 36\text{ V}$) Load ($I_O = I_{O, \text{min}}$ to $I_{O, \text{max}}$) Temperature (See Figures 2—5.) ($T_C = -40\text{ }^\circ\text{C to } +100\text{ }^\circ\text{C}$)	All	—	—	0.05	0.1	% V_O
	All	—	—	0.05	0.2	% V_O
	JC030D-M	—	—	0.3	1.0	% V_O
	A-M, B-M, C-M	—	—	0.5	1.5	% V_O
Output Ripple and Noise Voltage (See Figure 20.): RMS Peak-to-peak (5 Hz to 20 MHz)	JC030A-M, D-M	—	—	—	20	mVrms
	JC030B-M, C-M	—	—	—	25	mVrms
	JC030A-M, D-M	—	—	—	150	mVp-p
	JC030B-M, C-M	—	—	—	200	mVp-p
Output Current (At $I_O < I_{O, \text{min}}$, the modules may exceed output ripple specifications.)	JC030D-M	I_O	0.6	—	6.5	A
	JC030A-M	I_O	0.6	—	6.0	A
	JC030B-M	I_O	0.3	—	2.5	A
	JC030B-M	$I_{O, \text{trans}}$	—	—	3.0	A
	JC030C-M	I_O	0.2	—	2.0	A
Output Current-limit Inception ($V_O = 90\%$ of $V_{O, \text{nom}}$; see Figures 7—9.)	JC030D-M	I_O	—	8.0	—	A
	JC030A-M	I_O	—	6.9	—	A
	JC030B-M	I_O	—	3.6	—	A
	JC030C-M	I_O	—	2.5	—	A
Output Short-circuit Current ($V_O = 250\text{ mV}$)	JC030D-M	—	—	8.0	11.0	A
	JC030A-M	—	—	8.0	9.5	A
	JC030B-M	—	—	4.0	5.5	A
	JC030C-M	—	—	3.0	4.5	A
Efficiency ($V_I = 24\text{ V}$; $I_O = I_{O, \text{max}}$; $T_C = 25\text{ }^\circ\text{C}$; see Figures 11—13 and 21.)	JC030D-M	η	67	69	—	%
	JC030A-M	η	78	80	—	%
	JC030B-M, C-M	η	78	83	—	%
Switching Frequency	All	—	—	250	—	kHz

Electrical Specifications (continued)

Table 2. Output Specifications(continued)

Parameter	Device or Suffix	Symbol	Min	Typ	Max	Unit
Dynamic Response ($\Delta I_o/\Delta t = 1\text{ A}/10\ \mu\text{s}$, $V_i = 24\text{ V}$, $T_c = 25\text{ }^\circ\text{C}$; see Figures 14 and 16.):						
Load Change from $I_o = 50\%$ to 75% of $I_{o, \text{max}}$:						
Peak Deviation	D-M	—	—	10	—	% $V_{o, \text{set}}$
	A-M, B-M, C-M	—	—	2	—	% $V_{o, \text{set}}$
Settling Time ($V_o < 10\%$ peak deviation)	All	—	—	0.5	—	ms
Load Change from $I_o = 50\%$ to 25% of $I_{o, \text{max}}$:						
Peak Deviation	D-M	—	—	10	—	% $V_{o, \text{set}}$
	A-M, B-M, C-M	—	—	2	—	% $V_{o, \text{set}}$
Settling Time ($V_o < 10\%$ of peak deviation)	All	—	—	0.5	—	ms

Table 3. Isolation Specifications

Parameter	Min	Typ	Max	Unit
Isolation Capacitance	—	0.02	—	μF
Isolation Resistance	10	—	—	$M^{3/4}$

General Specifications

Parameter	Min	Typ	Max	Unit
Calculated MTBF ($I_o = 80\%$ of $I_{o, \text{max}}$; $T_c = 40\text{ }^\circ\text{C}$)	3,900,000			hours
Weight	—	—	100 (3.5)	g (oz.)

Feature Specifications

Unless otherwise indicated, specifications apply over all operating input voltage, resistive load, and temperature conditions. See Feature Descriptions and Design Considerations for further information.

Parameter	Device	Symbol	Min	Typ	Max	Unit
Remote On/Off ($V_I = 0\text{ V}$ to 36 V ; open collector or equivalent compatible; signal referenced to $V_I(-)$ terminal. See Figure 22 and Feature Descriptions.): JC030x-M Positive Logic Logic Low—Module Off Logic High—Module On JC030x1-M Negative Logic Logic Low—Module On Logic High—Module Off Module Specifications: On/Off Current—Logic Low On/Off Voltage: Logic Low Logic High ($I_{on/off} = 0$) Open Collector Switch Specifications: Leakage Current During Logic High ($V_{on/off} = 10\text{ V}$) Output Low Voltage During Logic Low ($I_{on/off} = 1\text{ mA}$) Turn-on Time (at 80% of $I_{O, max}$; $T_A = 25\text{ }^\circ\text{C}$; V_O within $\pm 1\%$ of steady state; see Figure 18.) Output Voltage Overshoot	All	$I_{on/off}$	—	—	1.0	mA
	All	$V_{on/off}$	-0.7	—	1.2	V
	All	$V_{on/off}$	—	—	6	V
	All	$I_{on/off}$	—	—	50	μA
	All	$V_{on/off}$	—	—	1.2	V
	All	—	—	30	90	ms
	All	—	—	0	5	%
Output Voltage Set-point Adjustment Range (See Feature Descriptions section.)	JC030A-M, D-M JC030B-M, C-M	—	80 60	—	110 110	% $V_{O, nom}$ % $V_{O, nom}$
Output Voltage Remote Sense Range	All	—	—	—	0.5	V
Output Overvoltage Protection (clamp)	JC030D-M JC030A-M JC030B-M JC030C-M	$V_{O, clamp}$ $V_{O, clamp}$ $V_{O, clamp}$ $V_{O, clamp}$	2.5 5.6 13.0 17.0	— — — —	4.0 7.0 16.0 20.0	V V V V

Characteristic Curves

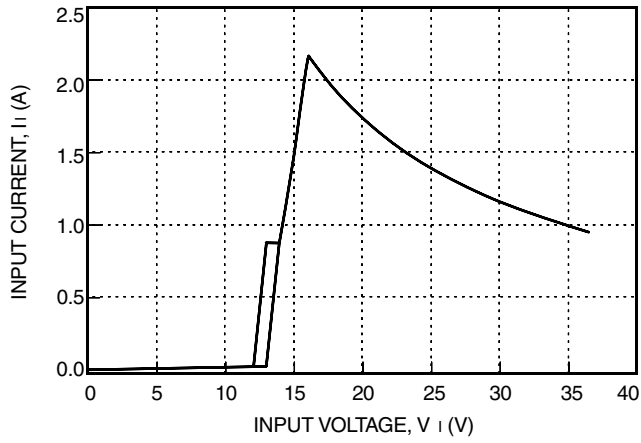

8-724(C)

Figure 1. JC030-Series Typical Input Characteristic

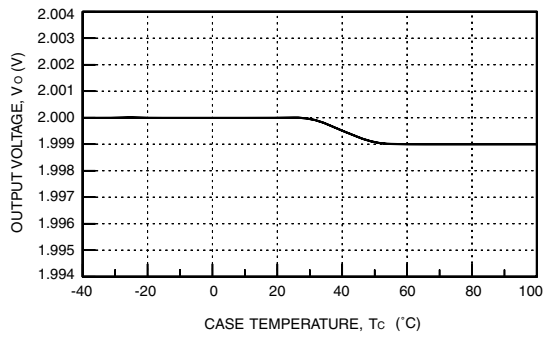

8-852(C).b

Figure 2. JC030D-M Typical Output Voltage Variation Over Ambient Temperature Range

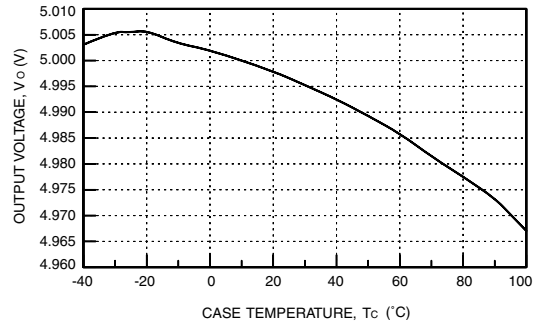

8-852(C)

Figure 3. JC030A-M Typical Output Voltage Variation Over Ambient Temperature Range

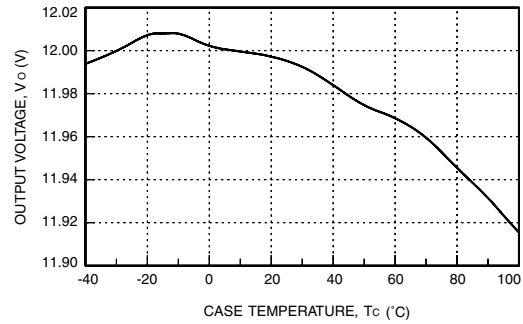

8-853(C)

Figure 4. JC030B-M Typical Output Voltage Variation Over Ambient Temperature Range

Characteristic Curves (continued)

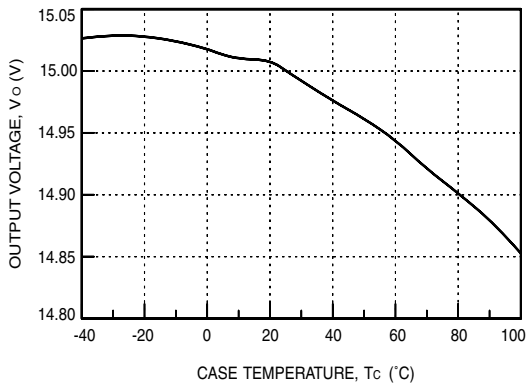

8-854(C)

Figure 5. JC030C-M Typical Output Voltage Variation Over Ambient Temperature Range

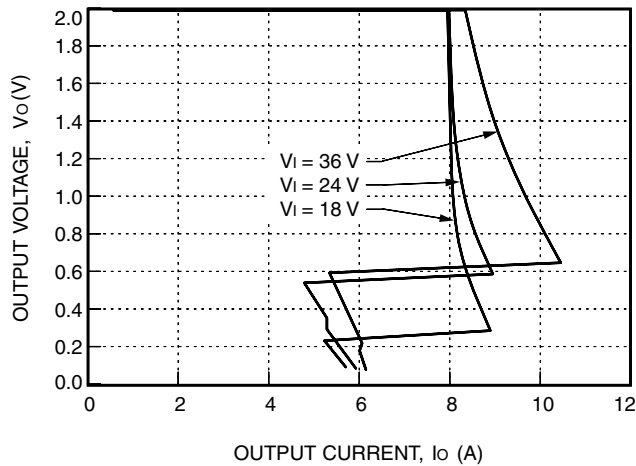

8-2692(C)

Figure 6. JC030D-M Typical Output Characteristics

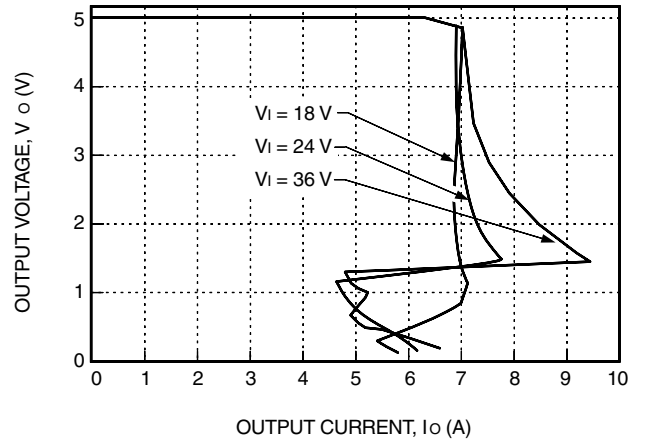

8-721(C)

Figure 7. JC030A-M Typical Output Characteristics

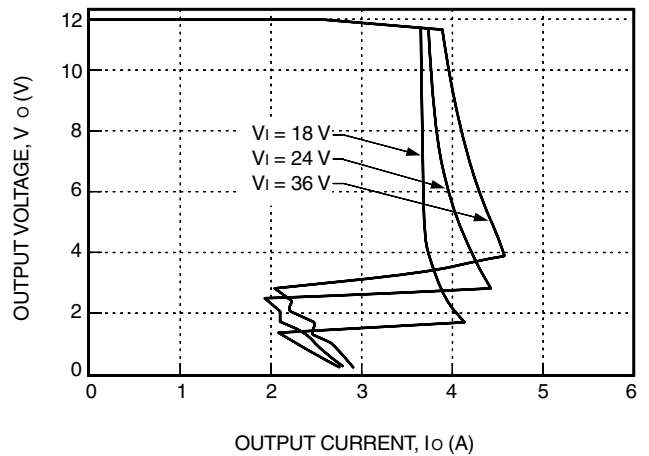

8-722(C)

Figure 8. JC030B-M Typical Output Characteristics

Characteristic Curves (continued)

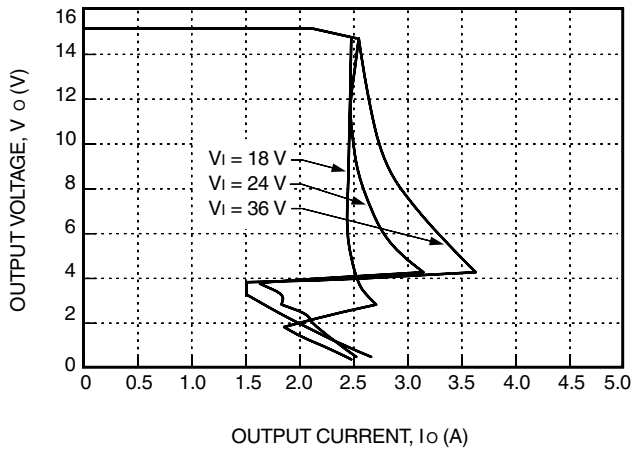

8-723(C)

Figure 9. JC030C-M Typical Output Characteristics

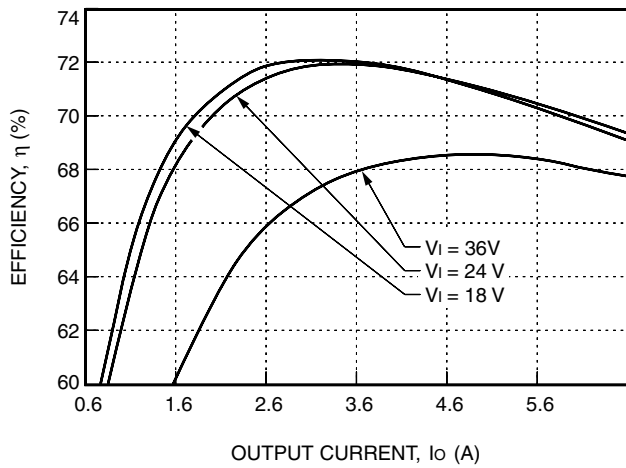

8-2691(C)

Figure 10. JC030D-M Typical Converter Efficiency vs. Output Current

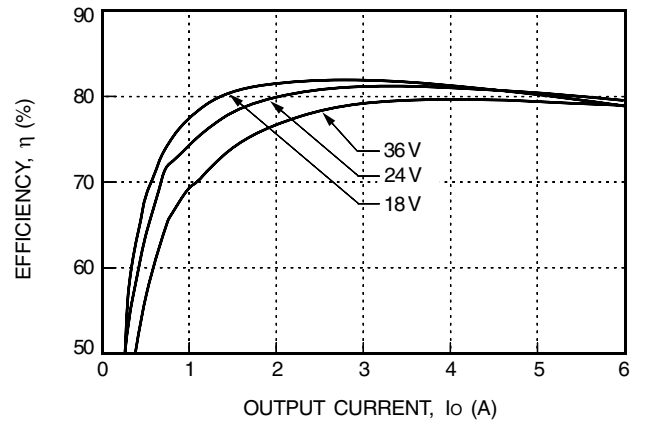

8-727(C)

Figure 11. JC030A-M Typical Converter Efficiency vs. Output Current

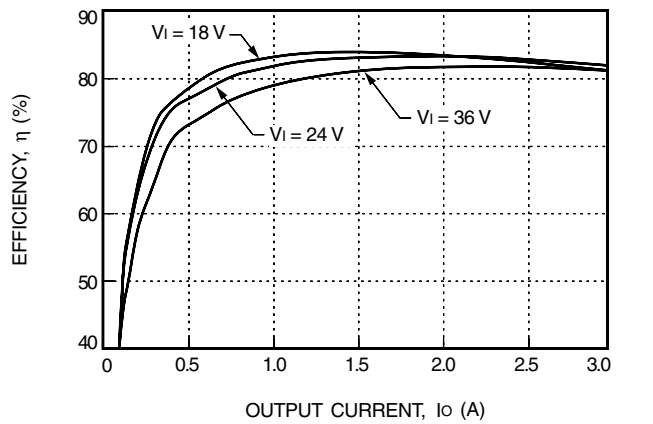

8-726(C)

Figure 12. JC030B-M Typical Converter Efficiency vs. Output Current

Characteristic Curves (continued)

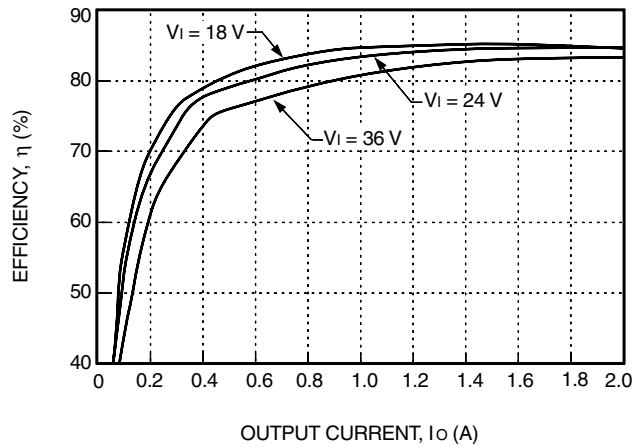

8-725(C)

Figure 13. JC030C-M Typical Converter Efficiency vs. Output Current

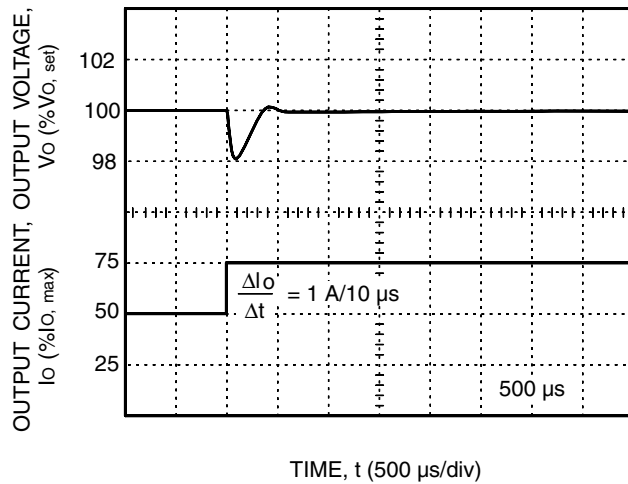

8-731(C)

Figure 14. JC030A, B, C-M Typical Output Voltage for a Step Load Change from 50% to 75%

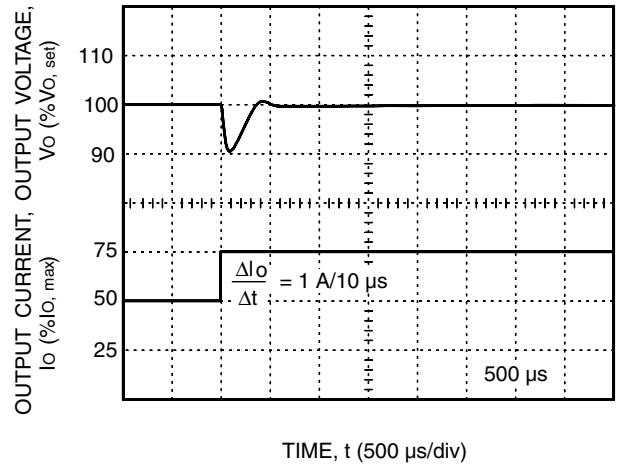

8-731(C).b

Figure 15. JC030D-M Typical Output Voltage for a Step Load Change from 50% to 75%

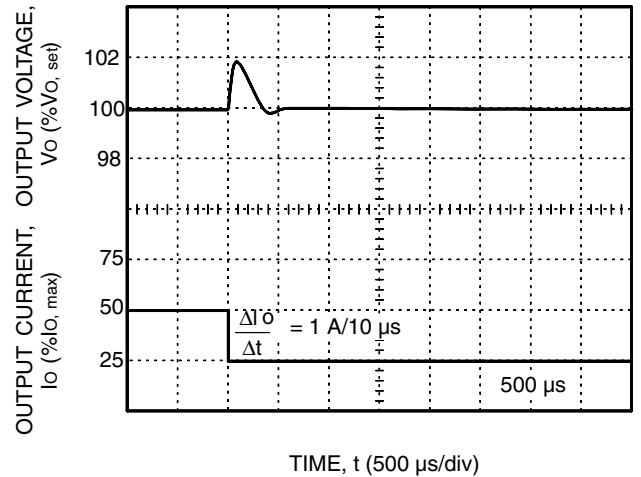

8-732(C).a

Figure 16. JC030A, B, C-M Typical Output Voltage for a Step Load Change from 50% to 25%

Characteristic Curves (continued)

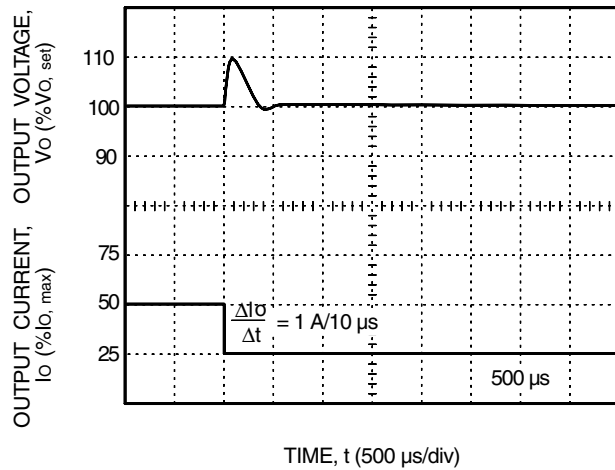

8-732(C).b

Figure 17. JC030D-M Typical Output Voltage for a Step Load Change from 50% to 25%

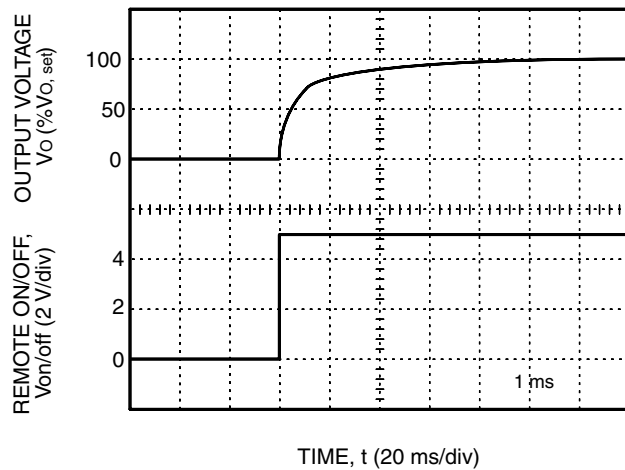

8-733(C).a

Figure 18. Typical Output Voltage Start-Up when Signal Applied to Remote On/Off

Test Configurations

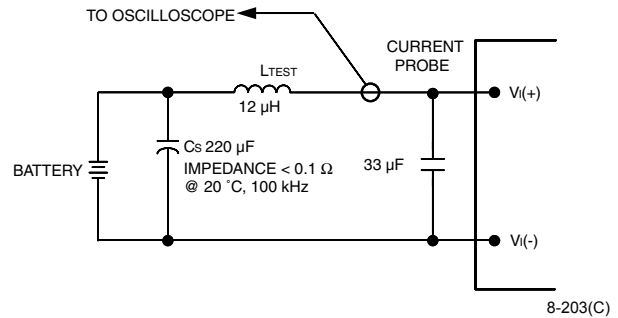

Note: Input reflected-ripple current is measured with a simulated source impedance of 12 μH. Capacitor Cs offsets possible battery impedance. Current is measured at the input of the module.

Figure 19. Input Reflected-Ripple Test Setup

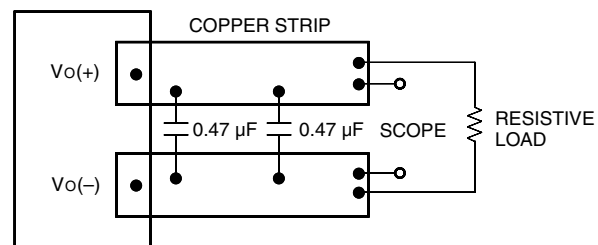

8-513(C).g

Note: Use two 0.47 μF ceramic capacitors. Scope measurement should be made using a BNC socket. Position the load between 50 mm and 75 mm (2 in. and 3 in.) from the module.

Figure 20. Peak-to-Peak Output Noise Measurement Test Setup

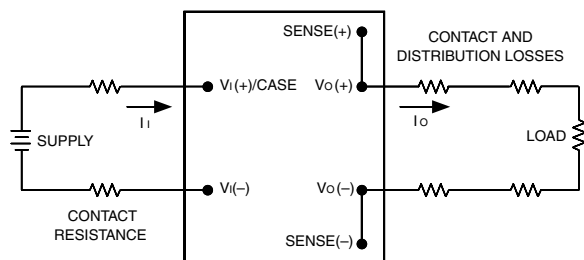

8-749(C).a

Note: All measurements are taken at the module terminals. When socketing, place Kelvin connections at module terminals to avoid measurement errors due to socket contact resistance.

$$\eta = \left(\frac{[V_{O(+)} - V_{O(-)}] I_o}{[V_{I(+)} - V_{I(-)}] I_i} \right) \times 100 \quad \%$$

Figure 21. Output Voltage and Efficiency Measurement Test Setup

Design Considerations

Grounding Considerations

The power module has an isolated case ground pin. The case is not connected internally allowing the user flexibility in grounding.

Input Source Impedance

The power module should be connected to a low ac-impedance input source. Highly inductive source impedances can affect the stability of the power module. A 33 μ F electrolytic capacitor (ESR < 0.7 $\frac{3}{4}$ at 100 kHz) mounted close to the power module helps ensure stability of the unit.

Safety Considerations

For safety-agency approval of the system in which the power module is used, the power module must be installed in compliance with the spacing and separation requirements of the end-use safety agency standard, i.e., UL 1950, CSA C22.2 No. 950-95, and VDE 0805 (EN60950, IEC950).

For the converter output to be considered meeting the requirements of safety extra-low voltage (SELV), the input must meet SELV requirements.

The power module has extra-low voltage (ELV) outputs when all inputs are ELV.

The input to these units is to be provided with a maximum 5 A normal-blow fuse in the ungrounded lead.

Feature Descriptions

Overcurrent Protection

To provide protection in a fault (output overload) condition, the unit is equipped with internal current-limiting circuitry and can endure current limiting for an unlimited duration. At the point of current-limit inception, the unit shifts from voltage control to current control. If the output voltage is pulled very low during a severe fault, the current-limit circuit can exhibit either foldback or tail-out characteristics (output current decrease or increase). The unit operates normally once the output current is brought back into its specified range.

Remote On/Off

Two remote on/off options are available. Positive logic remote on/off turns the module on during a logic-high voltage on the remote ON/OFF pin, and off during a logic low. Negative logic remote on/off, device code suffix "1," turns the module off during a logic high and on during a logic low. Standard modules provide positive logic remote on/off.

To turn the power module on and off, the user must supply a switch to control the voltage between the on/off terminal and the $V_I(-)$ terminal ($V_{on/off}$). The switch can be an open collector or equivalent (see Figure 22). A logic low is $V_{on/off} = -0.7$ V to 1.2 V. The maximum $I_{on/off}$ during a logic low is 1 mA. The switch should maintain a logic-low voltage while sinking 1 mA.

During a logic high, the maximum $V_{on/off}$ generated by the power module is 6 V. The maximum allowable leakage current of the switch at $V_{on/off} = 6$ V is 50 μ A.

The module has internal capacitance to reduce noise at the ON/OFF pin. Additional capacitance is not generally needed and may degrade the start-up characteristics of the module.

CAUTION: To avoid damaging the power module or external on/off circuit, the connection between the $V_I(-)$ pin and the input source must be made before or simultaneously to making a connection between the ON/OFF pin and the input source (either directly or through the external on/off circuit.)

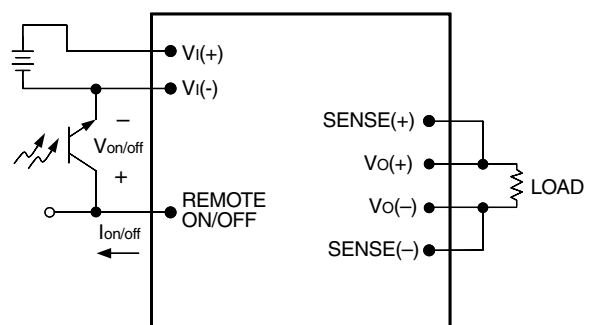

8-720(C).h

Figure 22. Remote On/Off Implementation

Feature Descriptions (continued)

Remote Sense

Remote sense minimizes the effects of distribution losses by regulating the voltage at the remote-sense connections. The voltage between the remote-sense pins and the output terminals must not exceed the output voltage sense range given in the Feature Specifications table, i.e.:

$$[V_{O(+)} - V_{O(-)}] - [SENSE(+)-SENSE(-)] \leq 0.5 V$$

The voltage between the $V_{O(+)}$ and $V_{O(-)}$ terminals must not exceed the minimum output overvoltage shutdown voltage as indicated in the Feature Specifications table. This limit includes any increase in voltage due to remote-sense compensation and output voltage set-point adjustment (trim). See Figure 23.

If not using the remote-sense feature to regulate the output at the point of load, then connect SENSE(+) to $V_{O(+)}$ and SENSE(-) to $V_{O(-)}$ at the module.

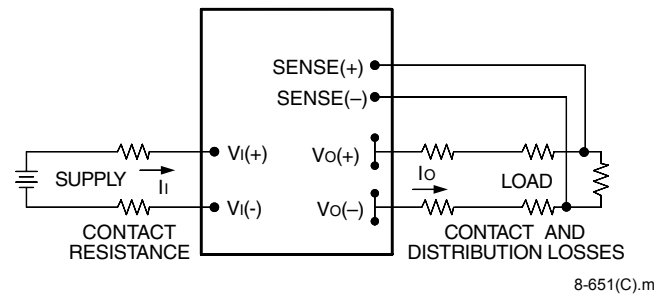

Figure 23. Effective Circuit Configuration for Single-Module Remote-Sense Operation

Output Voltage Adjustment

Output voltage trim allows the user to increase or decrease the output voltage set point of a module. This is accomplished by connecting an external resistor between the TRIM pin and either the SENSE(+) or SENSE(-) pins. With an external resistor between the TRIM and SENSE(-) pins ($R_{adj-down}$), the output voltage set point ($V_{O, adj}$) decreases (see Figure 24). The following equation determines the required external resistor value to obtain an output voltage change of % \hat{y} .

$$R_{adj-down} = \left(\frac{1 - \% \hat{y}}{\% \hat{y}} \right) 10 k\Omega$$

For example, to lower the output voltage by 30%, the external resistor value must be:

$$R_{adj-down} = \left(\frac{1 - 0.3}{0.3} \right) 10 k\Omega = 23.33 k\Omega$$

With an external resistor connected between the TRIM and SENSE(+) pins (R_{adj-up}), the output voltage set point ($V_{O, adj}$) increases (see Figure 25). The following equation determines the required external resistor value to obtain an output voltage change of % \hat{y} .

$$R_{adj-up} = \left(\frac{V_{O,nom}}{2.5} - 1 \right) \left(\frac{1 + \% \Delta}{\% \hat{y}} \right) 10 k\Omega$$

For example, to increase the output voltage of the JC030B by 5%, the external resistor value must be:

$$R_{adj-up} = \left(\frac{12.0}{2.5} - 1 \right) \left(\frac{1 + 0.05}{0.05} \right) 10 k\Omega = 798 k\Omega$$

The combination of the output voltage adjustment and sense range and the output voltage given in the Feature Specifications table cannot exceed 110% of the nominal output voltage between the $V_{O(+)}$ and $V_{O(-)}$ terminals.

The JC030 Power Module family has a fixed current-limit set point. Therefore, as the output voltage is adjusted down, the available output power is reduced. In addition, the minimum output current is a function of the output voltage. As the output voltage is adjusted down, the minimum required output current can increase.

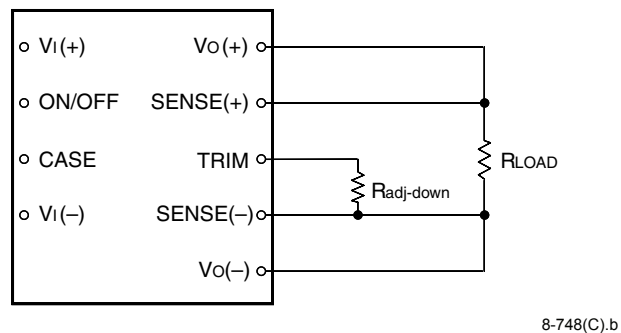

Figure 24. Circuit Configuration to Decrease Output Voltage

Feature Descriptions (continued)

Output Overvoltage Protection

Output Voltage Adjustment (continued)

The output overvoltage clamp consists of control circuitry, independent of the primary regulation loop, that monitors the voltage on the output terminals. The control loop of the clamp has a higher voltage set point than the primary loop (see Feature Specifications table). This provides a redundant voltage control that reduces the risk of output overvoltage.

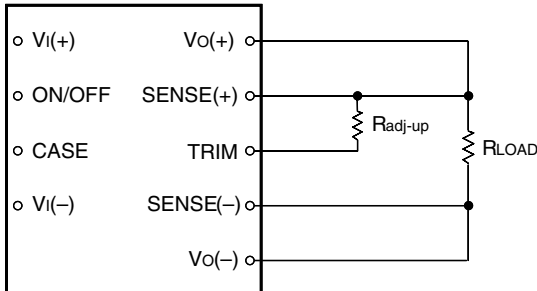

8-715(C).b

Figure 25. Circuit Configuration to Increase Output Voltage

Thermal Considerations

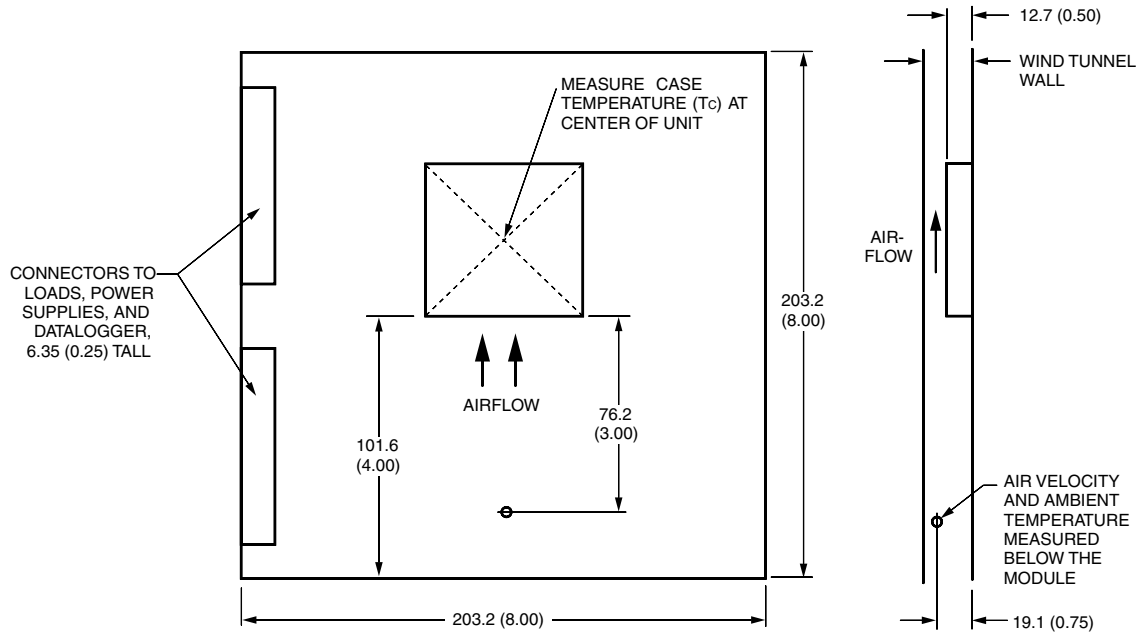

8-1046(C)

Note: Dimensions are in millimeters and (inches).

Figure 26. Thermal Test Setup

Thermal Considerations (continued)

The JC030-Series Power Modules are designed to operate in a variety of thermal environments. As with any electronic component, sufficient cooling must be provided to help ensure reliable operation. Heat-dissipating components inside the module are thermally coupled to the case to enable heat removal by conduction, convection, and radiation to the surrounding environment.

The thermal data presented is based on measurements taken in a wind tunnel. The test setup shown in Figure 26 was used to collect data for Figures 31 and 32.

Note that the natural convection condition was measured at 0.05 ms^{-1} to 0.1 ms^{-1} (10 ft./min. to 20 ft./min.); however, systems in which these power modules may be used typically generate natural convection airflow rates of 0.3 ms^{-1} (60 ft./min.) due to other heat dissipating components in the system.

The graphs in Figures 27 through 32 provide general guidelines for use. Actual performance can vary depending on the particular application environment. The maximum case temperature of $100 \text{ }^\circ\text{C}$ must not be exceeded.

Basic Thermal Performance

The JC030-Series power modules are built with a specially designed, heat spreading enclosure. As a result, full-load operation in natural convection at $50 \text{ }^\circ\text{C}$ can be achieved without the use of an external heat sink.

Higher ambient temperatures can be sustained by increasing the airflow or by adding a heat sink. As stated, this data is based on a maximum case temperature of $100 \text{ }^\circ\text{C}$ and measured in the test configuration shown in Figure 26.

Forced Convection Cooling

To determine the necessary airflow, determine the power dissipated by the unit for the particular application. Figures 27 through 30 show typical power dissipation for those power modules over a range of output currents. With the known power dissipation and a given local ambient temperature, the appropriate airflow can be chosen from the derating curves in Figure 31. For example, if the unit dissipates 6.2 W , the minimum airflow in an $80 \text{ }^\circ\text{C}$ environment is 1.02 ms^{-1} (200 ft./min.).

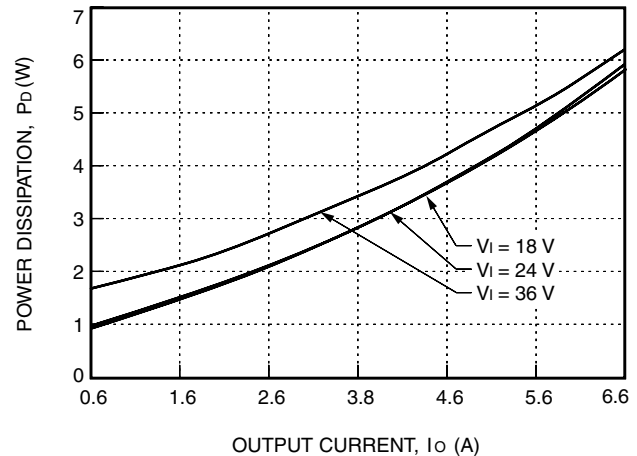

8-2690(C)

Figure 27. JC030D-M Power Dissipation vs. Output Current

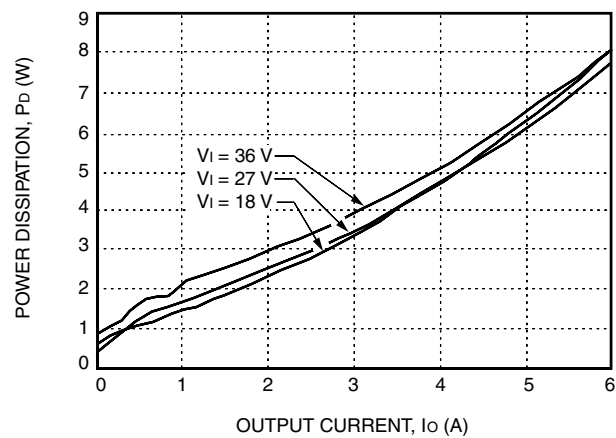

8-1154(C)

Figure 28. JC030A-M Power Dissipation vs. Output Current

Thermal Considerations (continued)

Forced Convection Cooling (continued)

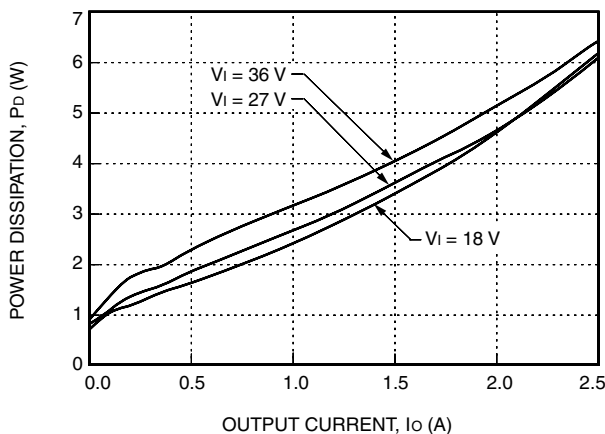

8-1211(C)

Figure 29. JC030B-M Power Dissipation vs. Output Current

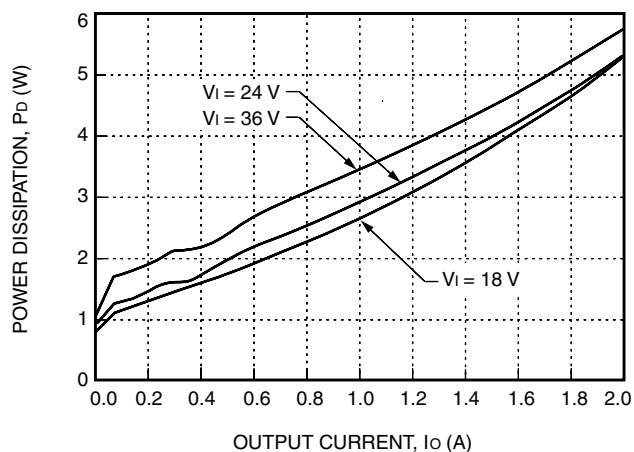

8-1212(C).a

Figure 30. JC030C-M Power Dissipation vs. Output Current

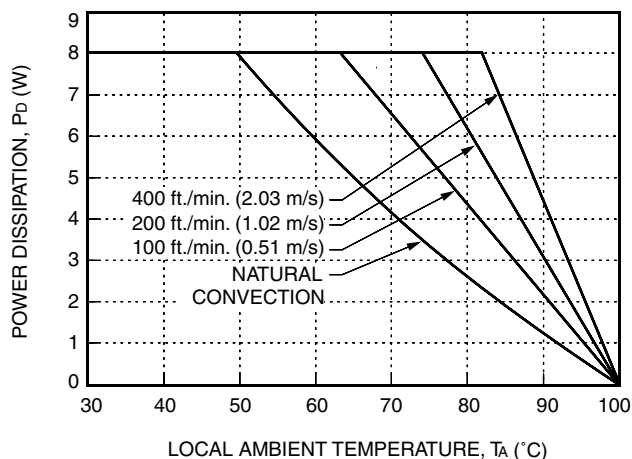

8-1051(C).a

Figure 31. Forced Convection Power Derating with No Heat Sink; Either Orientation

Heat Sink Selection

Several heat sinks are available for these modules. The case includes through threaded mounting holes allowing attachment of heat sinks or cold plates from either side of the module. The mounting torque must not exceed 0.56 N-m (5 in.-lb.).

Figure 32 shows the case-to-ambient thermal resistance, θ ($^{\circ}\text{C}/\text{W}$), for these modules. These curves can be used to predict which heat sink will be needed for a particular environment. For example, if the unit dissipates 7 W of heat in an 80 $^{\circ}\text{C}$ environment with an air-flow of 0.66 ms^{-1} (130 ft./min.), the minimum heat sink required can be determined as follows:

$$\theta \leq (T_{C, \max} - T_A) / P_D$$

where:

- θ = module's total thermal resistance
- $T_{C, \max}$ = case temperature (See Figure 26.)
- T_A = inlet ambient temperature (See Figure 26.)
- P_D = power dissipation

$$\theta \leq (100 - 80) / 7$$

$$\theta \leq 2.9 \text{ } ^{\circ}\text{C}/\text{W}$$

From Figure 32, the 1/2 inch high heat sink or greater is required.

Thermal Considerations (continued)

Heat Sink Selection (continued)

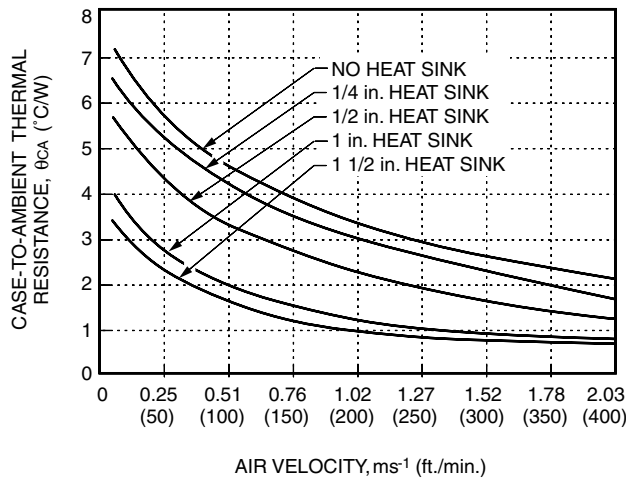

8-1052(C).a

Figure 32. Case-to-Ambient Thermal Resistance vs. Air Velocity Curves; Either Orientation

Although the previous example uses 100 °C as the maximum case temperature, for extremely high-reliability applications, one can use a lower temperature for $T_{C, max}$.

The thermal resistances shown in Figure 32 are for heat transfer from the sides and bottom of the module as well as the top side with the attached heat sink; therefore, the case-to-ambient thermal resistances shown will generally be lower than the resistance of the heat sink by itself. The data in Figure 32 was taken with a thermally conductive dry pad between the case and the heat sink to minimize contact resistance (typically 0.1 °C/W to 0.3 °C/W).

For a more detailed explanation of thermal energy management for this series of power modules as well as more details on available heat sinks, please request the following technical note: *Thermal Management JC- and JW-Series 30 W Board-Mounted Power Modules* (TN97-016EPS).

Layout Considerations

Copper paths must not be routed beneath the power module standoffs.

Outline Diagram

Dimensions are in millimeters and (inches).

Copper paths must not be routed beneath the power module standoffs.

Tolerances: $x.x \pm 0.5$ mm (0.02 in.), $x.xx \pm 0.25$ mm (0.010 in.).

Top View

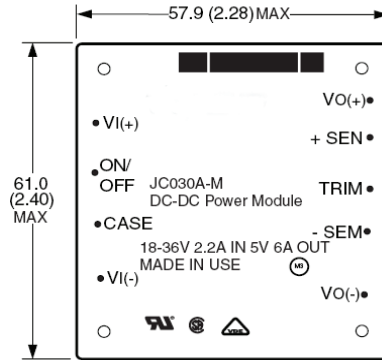

Side View

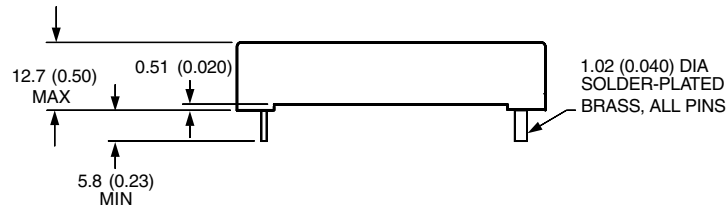

Bottom View

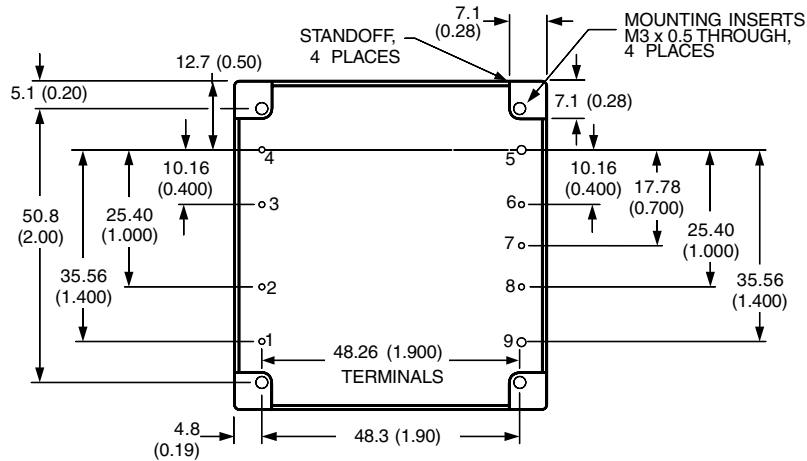

8-716(C).I

Recommended Hole Pattern

Component-side footprint.

Dimensions are in millimeters and (inches).

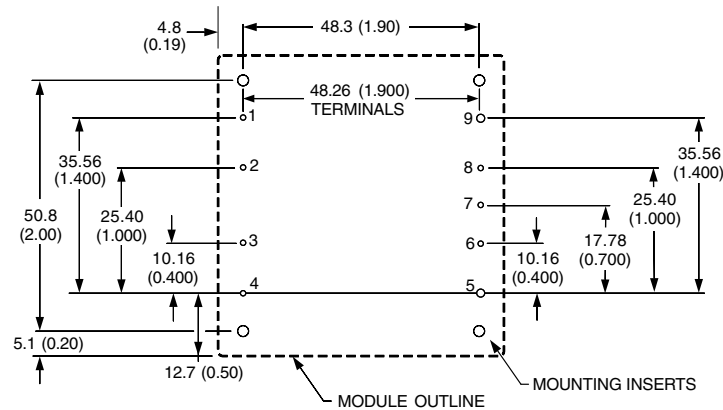

8-716(C).I

Ordering Information

Table 4. Device Codes

Input Voltage	Output Voltage	Output Power	Device Code	Comcode
24 V	2 V	13 W	JC030D-M	108272170
24 V	5 V	30 W	JC030A-M	107587719
24 V	12 V	30 W	JC030B-M	107587735
24 V	15 V	30 W	JC030C-M	107587768

Optional features may be ordered using the device code suffixes shown below. To order more than one option, list suffixes in numerically descending order followed by the -M suffix indicating metric (M3 x 0.5) heat sink hardware. The heat sinks designed for this package have an M prefix, i.e., MHSTxxx40, see *Thermal Management JC- and JW-Series 30 W Board-Mounted Power Modules* (TN97-016EPS).

Please contact your Lineage Power Account Manager or Field Application Engineer for pricing and availability.

Table 5. Device Options

Option	Device Code Suffix
Short pins: 2.79 mm ± 0.25 mm (0.110 in. ± 0.010 in.)	8
Negative remote on/off logic	1

Ordering Information (continued)

Table 6. Device Accessories

Accessory	Comcode
1/4 in. transverse kit (heat sink, thermal pad, and screws)	407243989
1/4 in. longitudinal kit (heat sink, thermal pad, and screws)	407243997
1/2 in. transverse kit (heat sink, thermal pad, and screws)	407244706
1/2 in. longitudinal kit (heat sink, thermal pad, and screws)	407244714
1 in. transverse kit (heat sink, thermal pad, and screws)	407244722
1 in. longitudinal kit (heat sink, thermal pad, and screws)	407244730
1 1/2 in. transverse kit (heat sink, thermal pad, and screws)	407244748
1 1/2 in. longitudinal kit (heat sink, thermal pad, and screws)	407244755

Note: Dimensions are in millimeters and (inches).

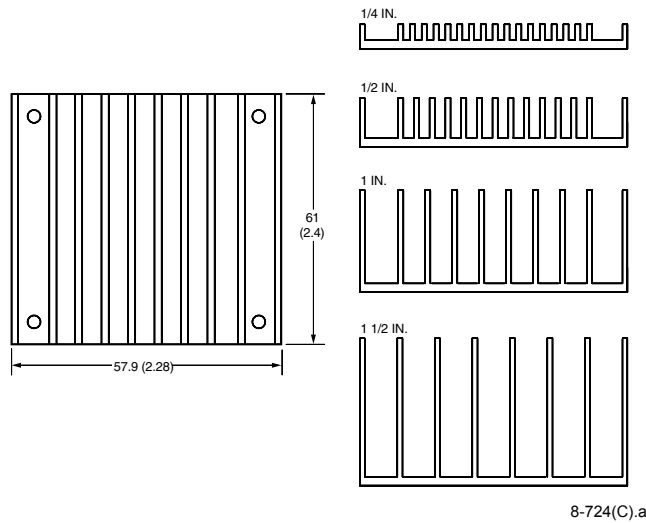

Figure 33. Longitudinal Heat Sink

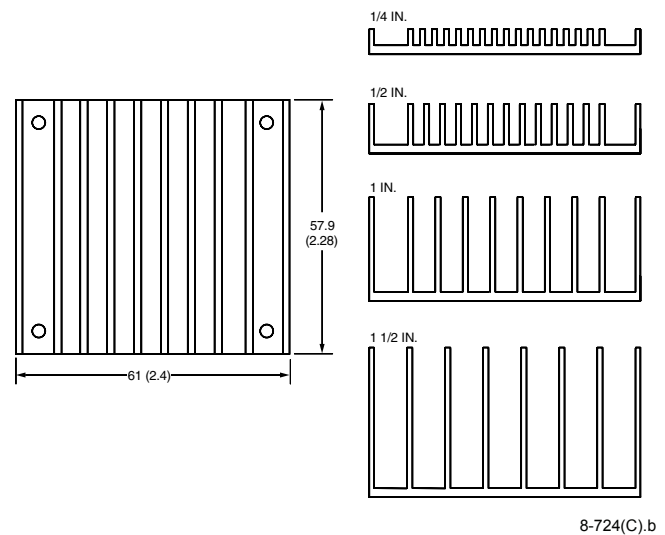

Figure 34. Transverse Heat Sink



World Wide Headquarters
Lineage Power Corporation
3000 Skyline Drive, Mesquite, TX 75149, USA
+1-800-526-7819
(Outside U.S.A.: **+1-972-284-2626**)
www.lineagepower.com
e-mail: techsupport1@lineagepower.com

Asia-Pacific Headquarters
Tel: +65 6416 4283

Europe, Middle-East and Africa Headquarters
Tel: +49 89 6089 286

India Headquarters
Tel: +91 80 28411633

Lineage Power reserves the right to make changes to the product(s) or information contained herein without notice. No liability is assumed as a result of their use or application. No rights under any patent accompany the sale of any such product(s) or information.

© 2008 Lineage Power Corporation, (Mesquite, Texas) All International Rights Reserved.

March 2008
DS99-123EPS (Replaces DS99-122EPS)