



Chipsmall Limited consists of a professional team with an average of over 10 year of expertise in the distribution of electronic components. Based in Hongkong, we have already established firm and mutual-benefit business relationships with customers from,Europe,America and south Asia,supplying obsolete and hard-to-find components to meet their specific needs.

With the principle of “Quality Parts,Customers Priority,Honest Operation,and Considerate Service”,our business mainly focus on the distribution of electronic components. Line cards we deal with include Microchip,ALPS,ROHM,Xilinx,Pulse,ON,Everlight and Freescale. Main products comprise IC,Modules,Potentiometer,IC Socket,Relay,Connector.Our parts cover such applications as commercial,industrial, and automotives areas.

We are looking forward to setting up business relationship with you and hope to provide you with the best service and solution. Let us make a better world for our industry!



## Contact us

Tel: +86-755-8981 8866 Fax: +86-755-8427 6832

Email & Skype: info@chipsmall.com Web: www.chipsmall.com

Address: A1208, Overseas Decoration Building, #122 Zhenhua RD., Futian, Shenzhen, China





# Specification LW551A

SSC		CUSTOMER
Drawn	Approval	Approval

# CONTENTS

1. Full code of Lamp LED series
2. Feature & Application
3. Absolute Maximum Ratings
4. Electro Characteristics
5. Outline Dimension
6. Optical characteristics
7. Color & Binning
8. Rank of LW551A
9. Standard of Taping Empty Space
10. Packing
11. Soldering
12. Precaution for use
13. Reliability Test Item and Condition

## 1. Full Code of Lamp LED Series

Full code form : X<sub>1</sub> X<sub>2</sub> X<sub>3</sub> X<sub>4</sub> X<sub>5</sub> X<sub>6</sub> X<sub>7</sub>X<sub>8</sub> X<sub>9</sub> - X<sub>10</sub>X<sub>11</sub>

### 1. Part Number

- X<sub>1</sub> : Model
- X<sub>2</sub> : Number of Die \*1
- X<sub>3</sub> : Color
- X<sub>4</sub> : Lens Shape
- X<sub>5</sub> : Directivity
- X<sub>6</sub> : Revision Symbol
- X<sub>7</sub> : High Reliability \*2
- X<sub>8</sub> : Surface coloring & Diffusion \*3
- X<sub>9</sub> : Stopper \*4

\*1, 2, 3, 4 are added to the Product Type only in necessary cases.

### 2. Internal Number

- X<sub>10</sub>
- X<sub>11</sub>

### 3. Sticker Diagram on Box & Aluminum Vinyl Bag

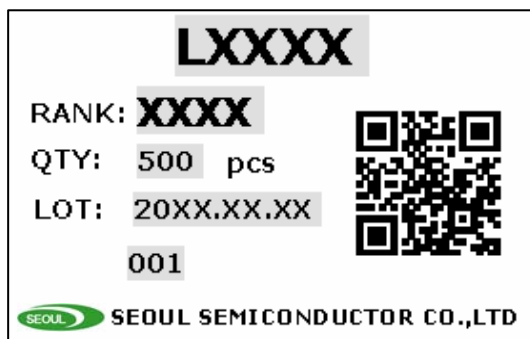

For more information about binning and labeling, refer to the Application Note -1

# LW551A

## Description

Lamp LEDs are effective in hot thermal and humid condition. This high brightness and weather-resistant packaging design makes these Lamp LEDs ideal for Outdoor applications such as traffic signals, variable message signs and backlighting for transparent sign panels.



# LW551A

## Features

- High luminous white emission
- Non-standoff leads
- 5mm package
- Viewing angle : 52 °
- Color Coordinates :  
x=0.31 y=0.31

## Applications

- Electronic signs and signals
- Specialty lighting
- Small area illumination
- Torches and head lamps
- Backlighting
- Outdoor displays

### 3. Absolute maximum ratings

Parameter	Symbol	Value	Unit
DC Forward Current	$I_F$	30	mA
Forward Peak Pulse Current	$I_{FP}^{*1}$	100	mA
Reverse Voltage	$V_R$	5	V
Power Dissipation	$P_D$	114	mW
Operating Temperature	$T_{opr}$	-35 ~ 85	°C
Storage Temperature	$T_{stg}$	-40 ~ 100	°C
Solder Temperature	$T_s$	260°C for 10seconds <sup>*2</sup>	°C

\*1  $t \leq 0.1\text{ms}$ ,  $D = 1/10$

\*2 No lower than 3mm from the base of the epoxy bulb.

### 4. Electric & Optical characteristics

Parameter	Symbol	Condition	Min	Typ	Max	Unit
Luminous Intensity <sup>*3</sup>	$I_V$	If=20mA	1750	2200		mcd
Luminous Flux	$\Phi_V$	If=20mA	-	2	-	lm
Chromaticity Coordinate <sup>*4</sup>	$x, y$	If=20mA	X=0.31, y=0.31			-
Forward Voltage <sup>*5</sup>	$V_F$	If=20mA	-	3.2	3.5	V
View Angle	$2\theta_{1/2}$	If=20mA	52			Deg.
Optical Efficiency	$\eta_{elc}$	If=20mA	-	32	-	lm/W
Reverse Current	$I_R$	$V_R = 5V$	-	-	5	$\mu A$

\*3. SSC maintains a tolerance of  $\pm 10\%$  on intensity and power measurements.

\*4. Correlated Color Temperature is derived from the CIE 1931 Chromaticity diagram.

It is measured with an integrated sphere. Color Coordinates Measurement allowance is  $\pm 0.01$

\*5. A tolerance of  $\pm 0.05V$  on forward voltage measurements

[Note] All measurements were made under the standardized environment of SSC.

### 5.Outline Dimension

Unit : mm

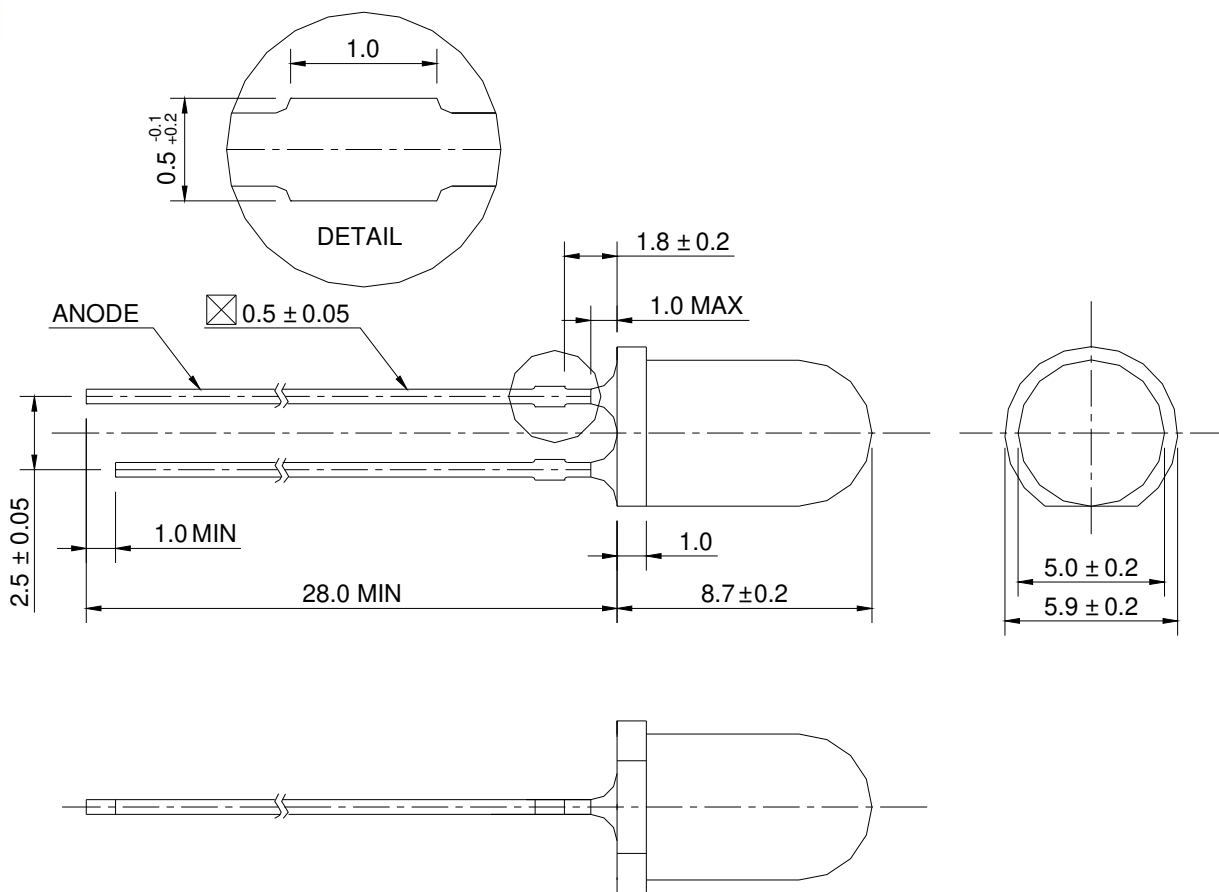

Notes : Protruded epoxy is 1.0mm maximum.

## 6. Optical characteristics

### Forward Current vs. Forward Voltage

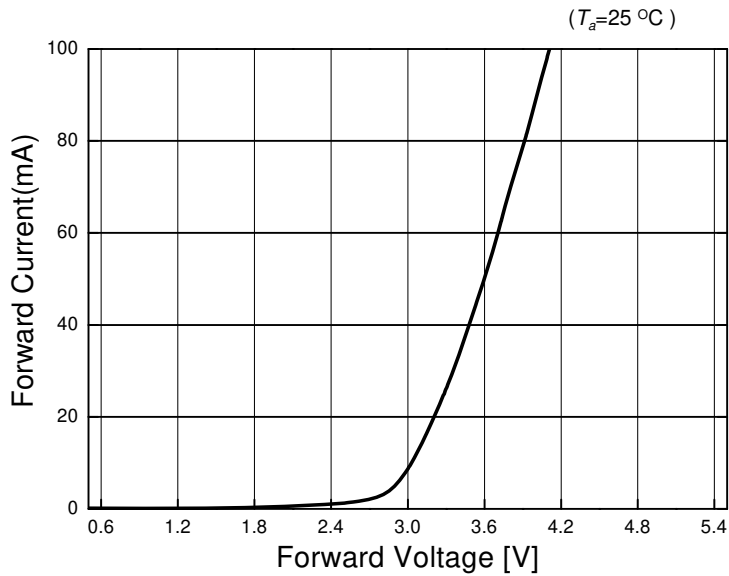

### Relative Luminous Intensity vs Forward Current

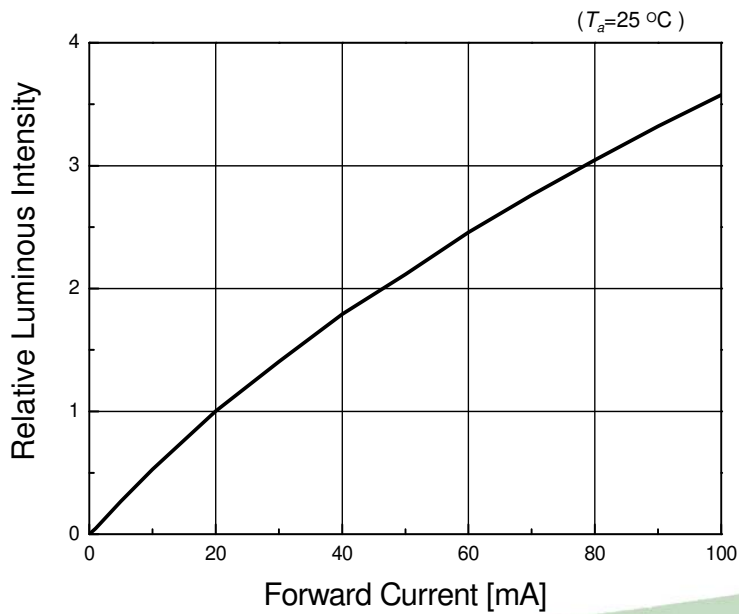



## 6. Optical characteristics

### Radiation Diagram

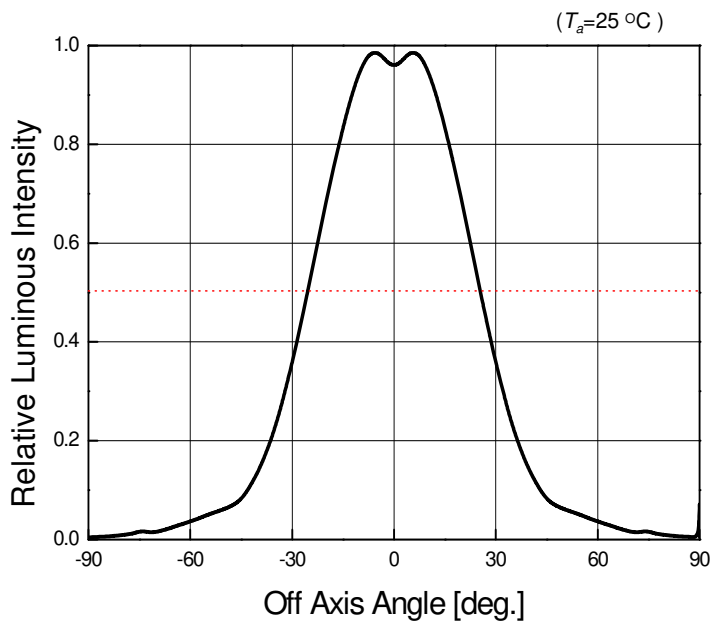

### Spectrum

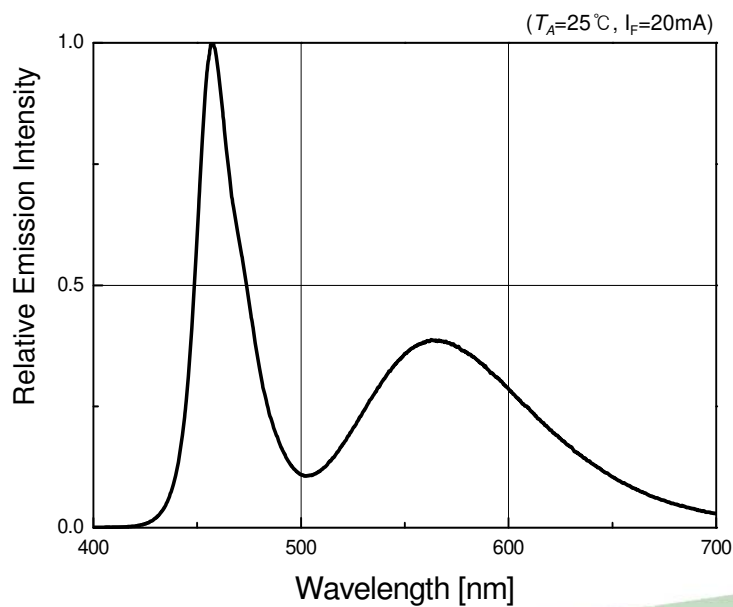

## 6. Optical characteristics

**Ambient Temperature vs. Maximum Forward Current**

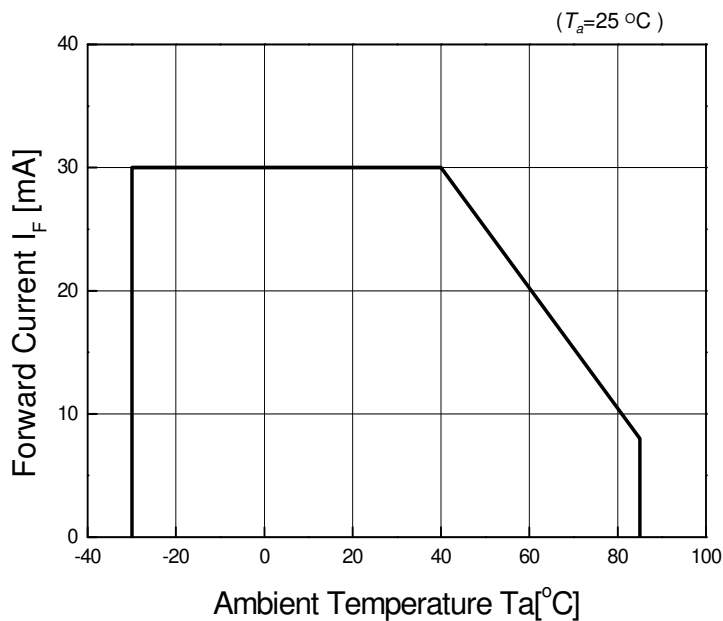

**Forward Current vs. Chromaticity Coordinate**

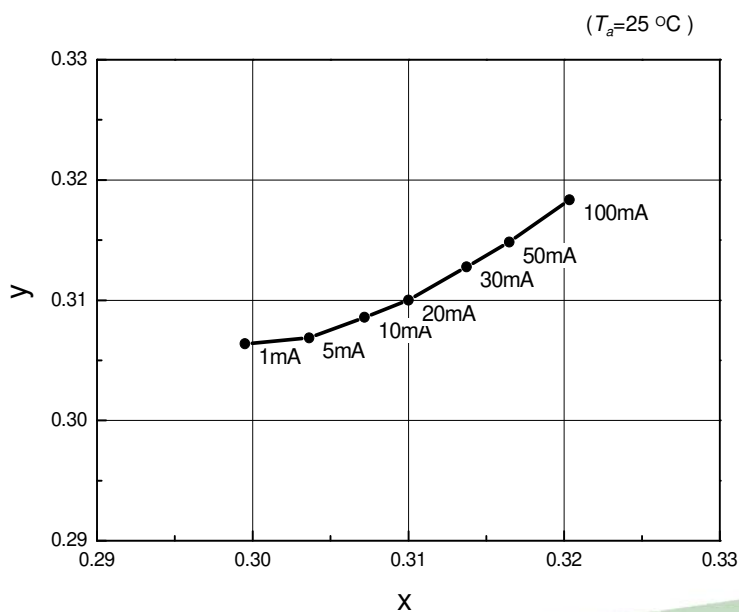

## 6. Optical characteristics

**Ambient Temperature vs. Relative Intensity**

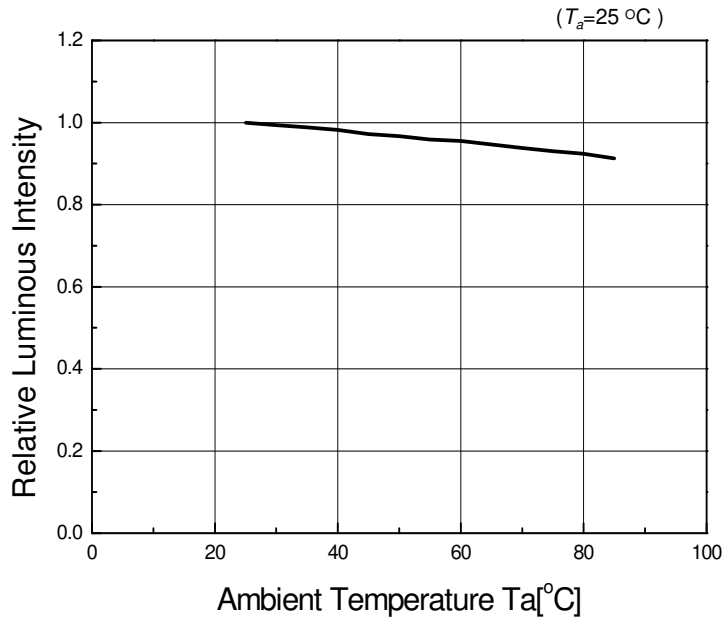

**Ambient Temperature vs. Forward Voltage**

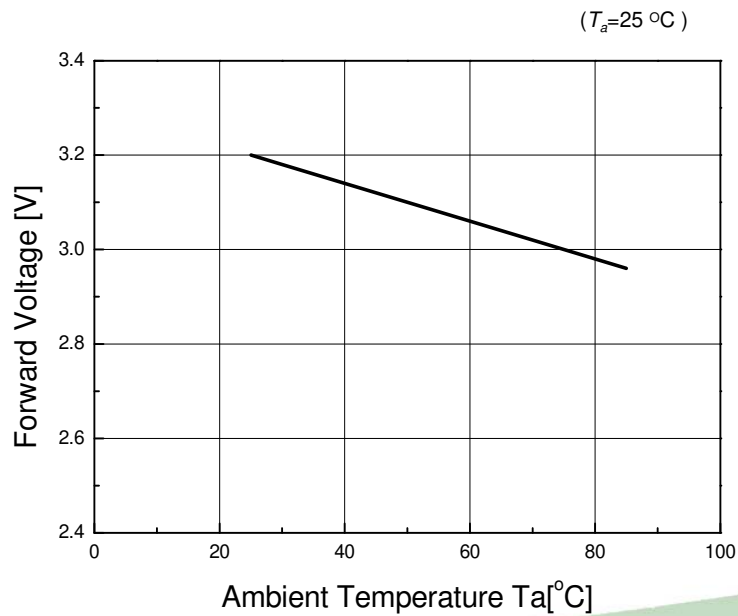

## 7. Color & Binning

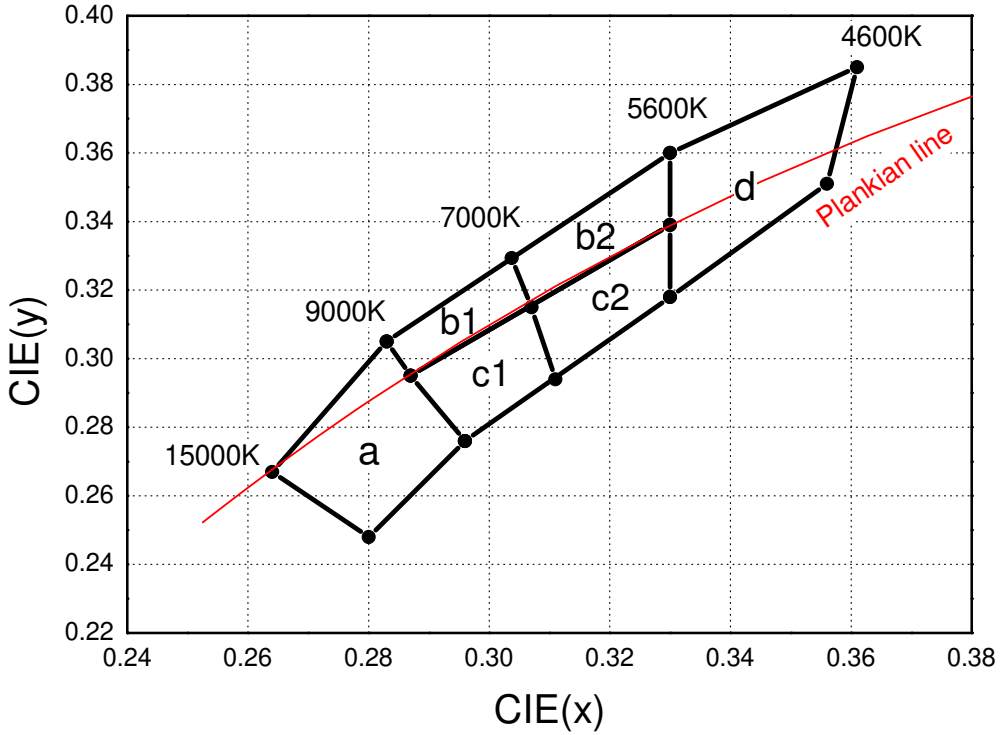

	Rank a			
x	0.264	0.280	0.296	0.283
y	0.267	0.248	0.276	0.305

	Rank b1			
x	0.287	0.283	0.304	0.307
y	0.295	0.305	0.330	0.315

	Rank b2			
x	0.307	0.304	0.330	0.330
y	0.315	0.330	0.360	0.339

	Rank c1			
x	0.296	0.287	0.307	0.311
y	0.276	0.295	0.315	0.294

	Rank c2			
x	0.311	0.307	0.330	0.330
y	0.294	0.315	0.339	0.318

	Rank d			
x	0.330	0.330	0.356	0.361
y	0.360	0.318	0.351	0.385

Note : Color Coordinates Measurement allowance is  $\pm 0.01$

### 8. Rank of LW551A

Bin Code		
Luminous Intensity	CIE	Forward Voltage
N	c1	4



Luminous Intensity (mcd) @ $I_F = 20\text{mA}$		
Bin Code	Min.	Max.
N	1750	2500
O	2500	3500

Color Rank @ $I_F = 20\text{mA}$
a
b1
b2
c1
c2
d

Forward Voltage (V) @ $I_F = 20\text{mA}$		
Bin Code	Min.	Max.
3	2.8	3.0
4	3.0	3.2
5	3.2	3.4
6	3.4	3.6
7	3.6	3.8
8	3.8	4.0

Available ranks

### 9. Standard of Taping Empty Space

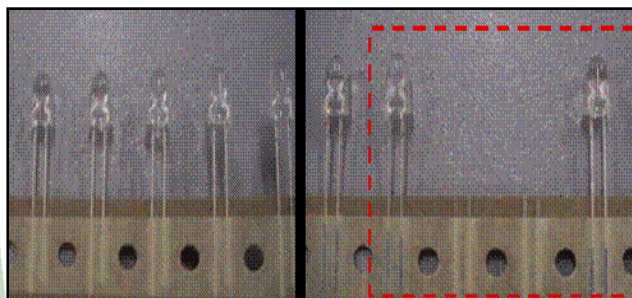

Before

After

Available Empty Space : 2ea

- \* Purpose : Prevention of being Mixed & Reverse mounting
- ※ Before : Insert the right PKG after removing defective product
- ※ After : Attaching the right PKG on the backside after removing defective product

10. Packing

Unit : mm

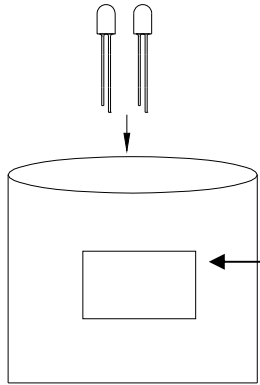

\* Antistatic poly bag  
(500pcs max/bag)

<b>LXXXX</b>	
RANK:	<b>XXXX</b>
QTY:	500 pcs
LOT:	20XX.XX.XX
	001
<b>SEOUL SEMICONDUCTOR CO.,LTD</b>	

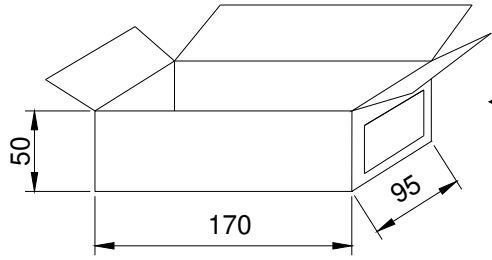

Inner box  
(1bag max/box)

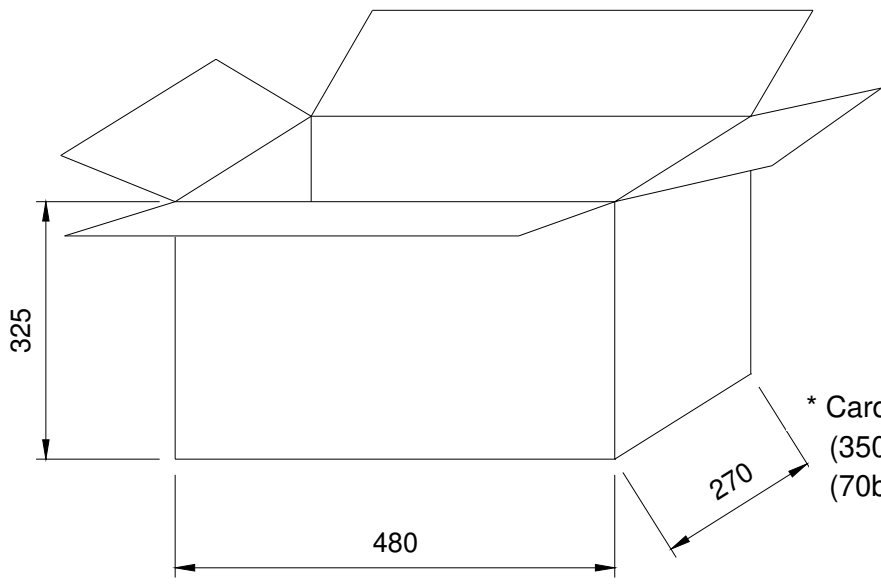

\* Cardboard box  
(35000pcs max/box)  
(70boxes max/box)

Unit : mm

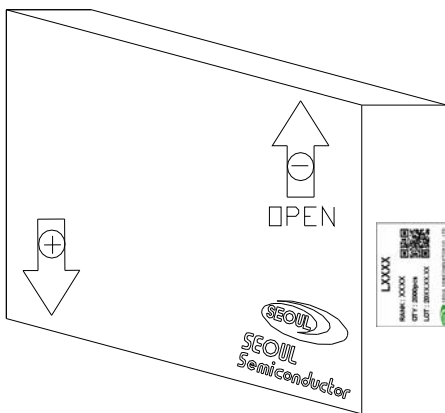
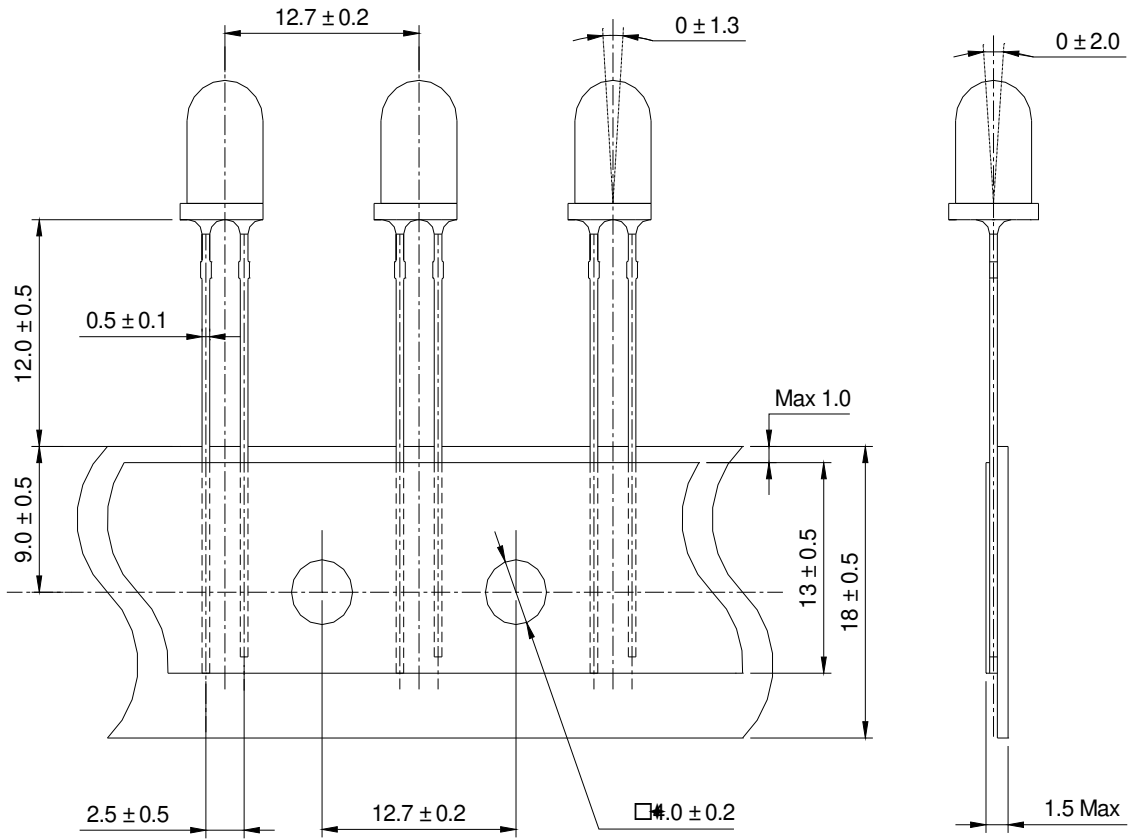

**LXXXX**

**RANK : XXXX**

**QTY : 2000pcs**

**LOT : 20XX.XX.XX**



**SEOUL SEMICONDUCTOR CO., LTD**

1 Box contain quantity.

\* 3φ Series : 3000pcs/box

\* 5φ Series : 2000pcs/box

Rev. 01

December 2010

[www.seoulsemicon.com](http://www.seoulsemicon.com)

## 11. Soldering

### 1) Wave Soldering Conditions / Profile

- Preliminary heating to be at 85°C(120 °C max) for 20 seconds(60 seconds max).
- Soldering heat to be at 255 °C (260°C max) for 10 seconds
- Soak time above 200 °C is 5 seconds

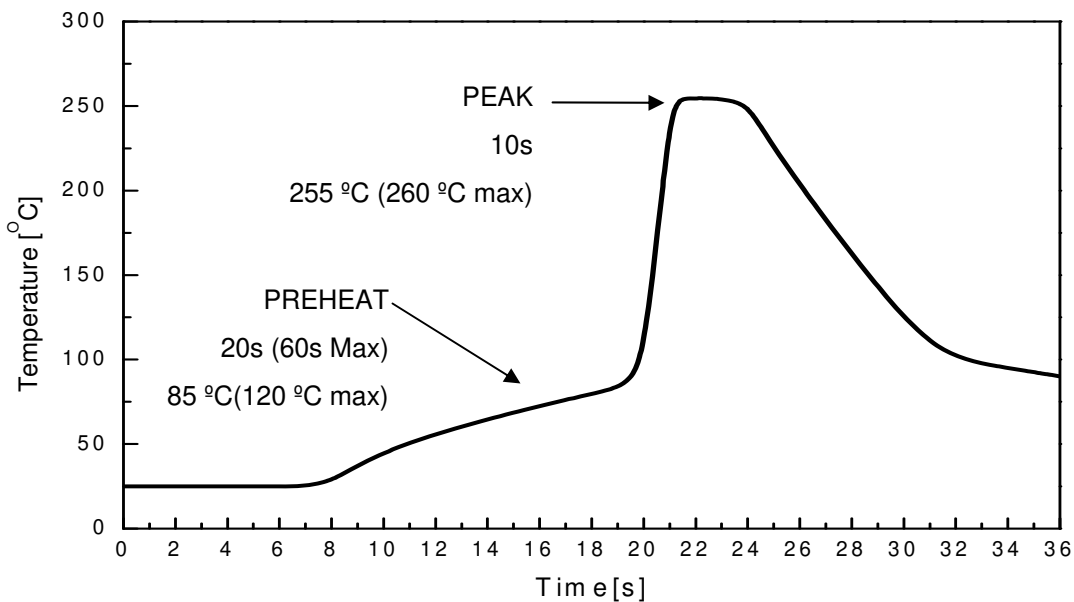

### 2) Hand Soldering conditions

- Not more than 3 seconds at max. 350°C, under Soldering iron.

### 3) Caution

- The LEDs must not be repositioned after soldering.
- Do not apply any stress to the lead particularly when heat.

Note : In case the soldered products are reused in soldering process, we don't guarantee the products.

Rev. 01

December 2010

[www.seoulsemicon.com](http://www.seoulsemicon.com)

Document No. : SSC-QP-7-07-24 (Rev.00)



## 12. Precaution for use

### 1) Storage

- Before opening the package
  - a. Avoid the absorption of moisture, we recommended to store the LEDs in a dry box(or desiccator) with a desiccant . Otherwise, store them in the following environment:  
Temperature : 5°C~30°C Humidity : 50% max.
  - b. The products should be used in 3 months. It is recommended that the LEDs be used as soon as possible.
- After opening the package
  - a. Soldering should be done right after opening the package(within 24Hrs).
  - b. Keeping of a fraction
    - Sealing
    - Temperature : 5 ~ 40°C, Humidity : less than 30%
  - c. If the package has been opened more than 1week or the color of desiccant changes, Components should be dried for 10-12hr at 60±5°C
- Any mechanical force or any excess vibration shall not be accepted to apply during cooling process to normal temp. after soldering.
- Avoid quick cooling
- Lead frames are silver plated SPCC. The silver plate surface may be affected by environments which contains corrosive substances. Please avoid conditions which may cause the LEDs to corrode, tarnish or discolor.

### 2) Lead Forming

- When the lead forming is required before soldering , care must be taken to avoid any bending and mechanical stress. The stress to the base may damage the LEDs.
- When mounting the LEDs onto a PCB, the holes on the circuit board should be exactly aligned with the leads of the LEDs.
- It is recommended that tooling made to precisely form and cut the leads to length rather than rely on hand operating.

### 3) Static Electricity

- Static Electricity and surge voltage damage the LEDs. So it is recommended that a wrist band or an anti-electrostatic glove be used when handling the LEDs.
- All devices, equipment and machinery must be grounded properly. It is recommended that precautions should be taken against surge voltage to the equipment that mounts the LEDs.

### 4) Heat Generation

- Thermal is one of the important parameters to design the end product. Please consider the heat generation of the LEDs.
- The operating current should be decided after considering the ambient maximum temperature of LEDs.

### 5) Others

- The color of the LEDs is changed slightly an operating current and thermal.
- Anti radioactive ray design is not considered for the products listed here.
- Gallium arsenide is used in some of the products listed in this publication. These products are dangerous if they are burned or smashed in the process of disposal. It is also dangerous to drink the liquid or inhale the gas generated by such products when chemically disposed.
- This device should not be used in any type of fluid such as water, oil, organic solvent and etc. When washing is required, IPA(Isopropyl Alcohol) should be used.
- When the LEDs are illuminating, operating current should be decided after considering the junction temperature.

Cf.) Please refer *Ambient temperature vs. Forward Current* graph on page 5

- The appearance and specifications of the product may be modified for improvement without notice.

### 13. Reliability Test Item and Condition

Item	Condition	Note	Failures
Life Test	$T_a = RT, I_F = 30mA$	1000hrs	0/22
High Temperature Operating	$T_a = 85^{\circ}C, I_F = 8mA$	1000hrs	0/22
Low Temperature Operating	$T_a = -30^{\circ}C, I_F = 20mA$	1000hrs	0/22
Thermal Shock	$T_a = -40^{\circ}C$ (30min) ~ $100^{\circ}$ (30min) (Transfer time : 10sec, 1Cycle = 1hr)	100 cycles	0/40
Resistance to soldering Heat	$T_s = 255 \pm 5^{\circ}C, t = 10sec$	1 time	0/22
ESD (Human Body Model)	1kV, 1.5k $\Omega$ ; 100pF	1 time	0/22
High Temperature Storage	$T_a = 100^{\circ}C$	1000hrs	0/22
Low Temperature Storage	$T_a = -40^{\circ}C$	1000hrs	0/22
Temperature Humidity Storage	$T_a = 85^{\circ}C, RH = 85%$	1000hrs	0/22
Temperature Humidity Operating	$T_a = 85^{\circ}C, RH = 85%, I_F = 8mA$	100hrs	0/22

#### < Judging Criteria For Reliability Tests >

$V_F$	USL <sup>[1]</sup> X 1.2
$\phi_V$	LSL <sup>[2]</sup> X 0.5

Notes :

[1] USL : Upper Standard Level

[2] LSL : Lower Standard Level.