



Chipsmall Limited consists of a professional team with an average of over 10 year of expertise in the distribution of electronic components. Based in Hongkong, we have already established firm and mutual-benefit business relationships with customers from,Europe,America and south Asia,supplying obsolete and hard-to-find components to meet their specific needs.

With the principle of “Quality Parts,Customers Priority,Honest Operation,and Considerate Service”,our business mainly focus on the distribution of electronic components. Line cards we deal with include Microchip,ALPS,ROHM,Xilinx,Pulse,ON,Everlight and Freescale. Main products comprise IC,Modules,Potentiometer,IC Socket,Relay,Connector.Our parts cover such applications as commercial,industrial, and automotives areas.

We are looking forward to setting up business relationship with you and hope to provide you with the best service and solution. Let us make a better world for our industry!



Contact us

Tel: +86-755-8981 8866 Fax: +86-755-8427 6832

Email & Skype: info@chipsmall.com Web: www.chipsmall.com

Address: A1208, Overseas Decoration Building, #122 Zhenhua RD., Futian, Shenzhen, China



LX-100 SERIES

Related Information

- General terms and conditions..... F-7
- Sensor selection guideP.885~
- Glossary of terms..... P.1455~
- General precautions P.1458~



panasonic.net/id/pidsx/global



Introduction of the 3 LED mark sensor

Can detect any mark!

Coaxial reflective optics and a sharp 1 × 5 mm 0.039 × 0.197 in spot enable high precision sensing. Stable detection of marks is possible.



R•G•B light emitting elements all in one

To detect any marking, this unit is equipped with red, green and blue LED light emitting elements all in one.

High precision coaxial reflective optical system

Panasonic Industrial Devices SUNX's unique coaxial reflective optics technology ensures very accurate sensing. The unit is made with a scratchproof glass lens.

- Total reflection mirror
- Half mirror
- Glass lens

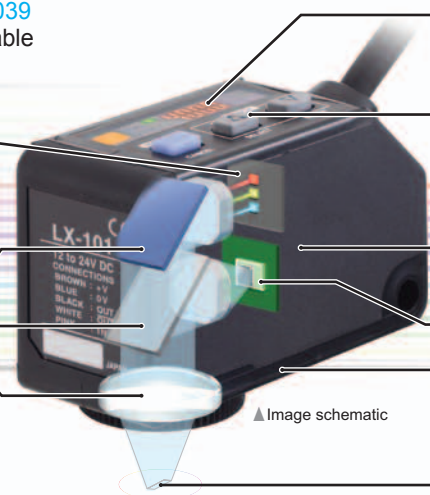

4-digit digital display

The 4-digit digital display enables numerical sensing control and minute settings.

Operation panel

3 large buttons that click into position making operation easy.



12-bit A/D converter

A resolution of 1/4,000 is realized to enable high precision mark sensing.

Receiving element

Protection IP67

Washing the machines and production line with water will not affect the sensor thanks to its waterproof construction.

Spot size 1 × 5 mm 0.039 × 0.197 in approx.

Automatic optimal LED selection function

The 3 colors of the R•G•B LEDs are optimally selected according to the color combination. With the LX-100's Mark mode, the built-in "Automatic optimal LED selection function" automatically selects the LED for the largest contrast (S / N ratio) between the mark and base (non-mark area) to ensure optimal sensing. For more stable detection, the sensor makes selection according to the contrast and not according to the reflected light variation between the mark and base (non-mark area).

(The example on the right deals with reflected light on packing film. Great figures are indicated for the blue LED's light amount ratio and, for even more stable sensing, the blue LED effectuates this mark sensing.)

Example: A packing film

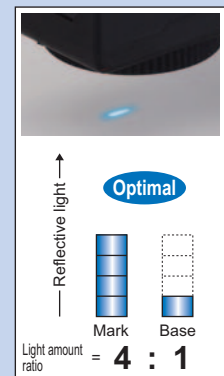
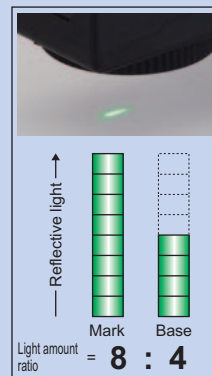
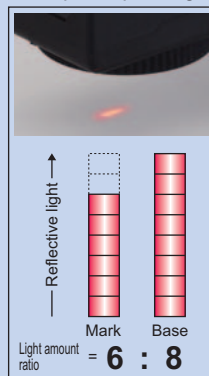

Two detection modes can be selected from to suit the application

Mark mode Ultra high-speed response

This sensing mode automatically selects a single color from the 3 R•G•B LEDs to achieve an ultra quick 45 μs response time. The automatic optimal LED selection function automatically selects the LED that is most suitable for the sensing. This function is perfect for ultra quick sensing.

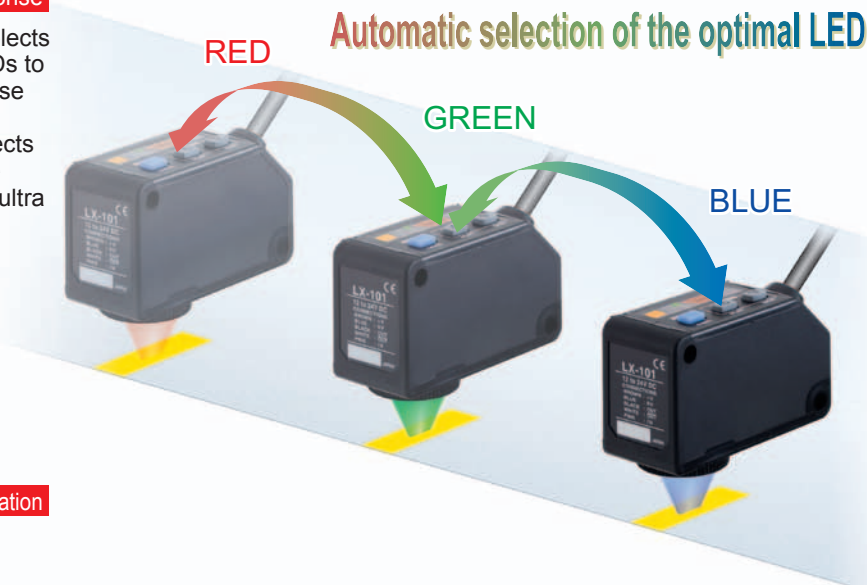

Color mode High precision discrimination

All 3 R•G•B LEDs light up and high precision mark color discrimination occurs using the R•G•B reflective light ratio. This function enables effective detection of films with patterns around the area of the mark.

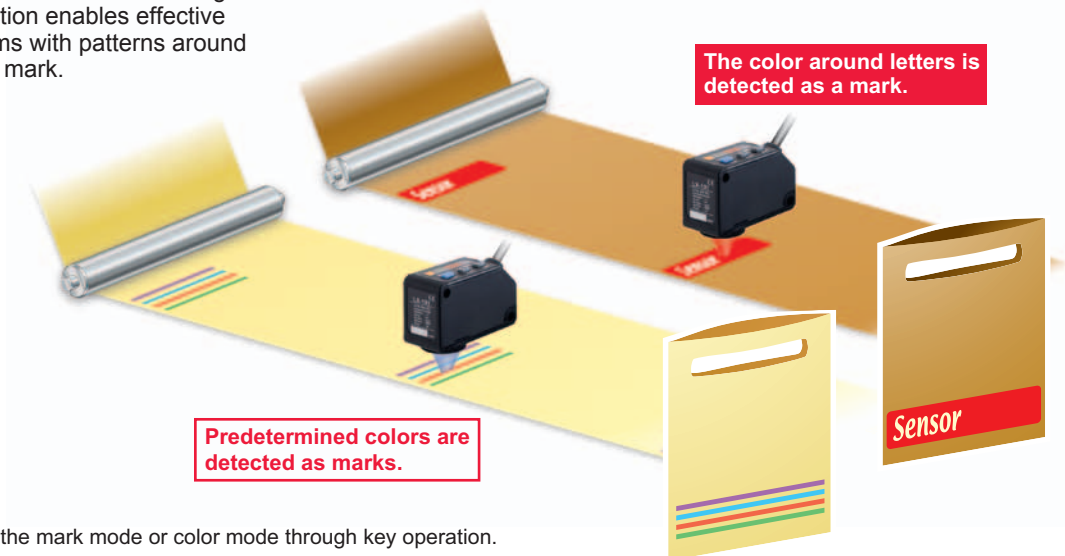

* You can select the mark mode or color mode through key operation.

High precision mark color discrimination

The color mode on the LX-100 series utilizes all 3 R•G•B LEDs to determine the R•G•B ratio of the mark color. The built-in 12-bit A/D converter enables high precision 1/4,000-resolution judgments. The figure below is a graphic description of this process.

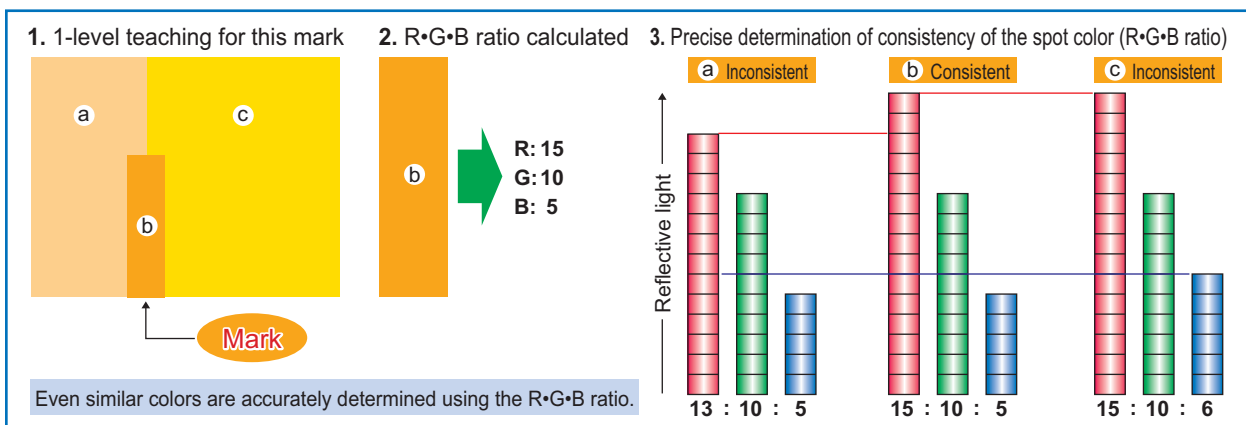

- FIBER SENSORS
- LASER SENSORS
- PHOTOELECTRIC SENSORS
- MICRO PHOTOELECTRIC SENSORS
- AREA SENSORS
- LIGHT CURTAINS / SAFETY COMPONENTS
- PRESSURE / FLOW SENSORS
- INDUCTIVE PROXIMITY SENSORS
- PARTICULAR USE SENSORS
- SENSOR OPTIONS
- SIMPLE WIRE-SAVING UNITS
- WIRE-SAVING SYSTEMS
- MEASUREMENT SENSORS
- STATIC ELECTRICITY PREVENTION DEVICES
- LASER MARKERS
- PLC
- HUMAN MACHINE INTERFACES
- ENERGY CONSUMPTION VISUALIZATION COMPONENTS
- FA COMPONENTS
- MACHINE VISION SYSTEMS
- UV CURING SYSTEMS

- Selection Guide
- Wafer Detection
- Liquid Leak Detection
- Liquid Level Detection
- Water Detection
- Color Mark Detection
- Hot Melt Glue Detection
- Ultrasonic
- Small / Slim Object Detection
- Obstacle Detection
- Other Products

LX-100
FZ-10

- FIBER SENSORS
- LASER SENSORS
- PHOTOELECTRIC SENSORS
- MICRO PHOTOELECTRIC SENSORS
- AREA SENSORS
- LIGHT CURTAINS / SAFETY COMPONENTS
- PRESSURE / FLOW SENSORS
- INDUCTIVE PROXIMITY SENSORS
- PARTICULAR USE SENSORS
- SENSOR OPTIONS
- SIMPLE WIRE-SAVING UNITS
- WIRE-SAVING SYSTEMS
- MEASUREMENT SENSORS
- STATIC ELECTRICITY PREVENTION DEVICES
- LASER MARKERS
- PLC
- HUMAN MACHINE INTERFACES
- ENERGY CONSUMPTION VISUALIZATION COMPONENTS
- FA COMPONENTS
- MACHINE VISION SYSTEMS
- UV CURING SYSTEMS
- Selection Guide
- Wafer Detection
- Liquid Leak Detection
- Liquid Level Detection
- Water Detection
- Color Mark Detection
- Hot Melt Glue Detection
- Ultrasonic
- Small / Slim Object Detection
- Obstacle Detection
- Other Products

Its digital display makes settings easy! Numerical control of the settings is possible

The 4-digit digital display enables easy verification of received light from marks and base (non-mark area). Also, the threshold value can be controlled numerically enabling setting indication easily. Displaying the direct code enables settings verification. This function is handy for remote maintenance.



Even beginners can quickly master MODE NAVI operation

The sensor's basic operations are represented by 6 indicators (MODE NAVI). The user can check what mode the sensor is presently in with a quick glance making operation simple.

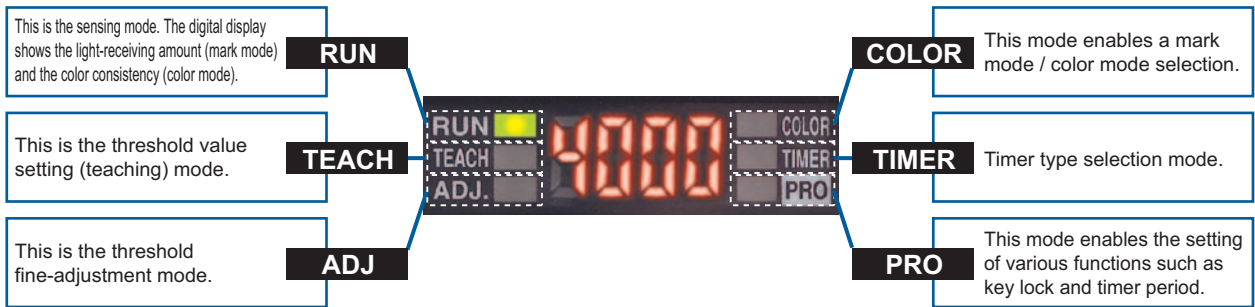

Sensing status digitally controllable

The sensing status, displayed numerically, can be verified at a glance. Also, the sensor settings for each type of packing film can be digitally indicated.

• Example of sensor setting indication

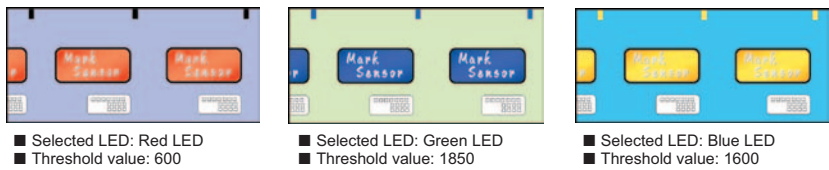

Direct codes enable settings verification at a glance

The settings for the LX-100 series sensors are displayed using a 4-digit direct code. Direct codes enable easy setting verification and maintenance by phone.



Direct code table (D-Code)

The sensor setting modes can be verified by a 4-digit code (D-Code). The table below shows a list of all available codes.

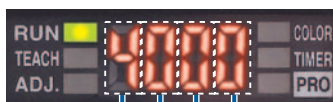

• When in RUN mode, press the MODE key for at least 2 sec. to display the direct code. (Remove your finger from the MODE key and the direct code will disappear.)

1st digit				2nd digit				3rd digit			4th digit	
Display	Sensing mode (light source color)	Operation mode (Note 1)	Sensing (Note 2)	Display	Display mode	ECO mode (Note 4)	Turn mode (Note 5)	Display	Key lock	Timer mode	Display	Timer period
[Green]	Mark mode (green)	L-ON	FINE	[Red]	Standard	OFF	OFF	[Red]	Full lock (All operations disabled)	non	[Red]	1 ms
			COARSE			ON	OFF-delay			[Red]	2 ms	
		D-ON	FINE			ON-delay	[Red]			5 ms		
	Mark mode (blue)	L-ON	COARSE			non	[Red]			10 ms		
			D-ON			OFF-delay	[Red]			20 ms		
		FINE	ON-delay			[Red]	50 ms					
[Red]	Mark mode (red)	L-ON	COARSE	[Red]	Percent display (Note 3)	OFF	OFF	[Red]	RUN teaching (Teaching only enabled)	non	[Red]	100 ms
			D-ON			FINE	ON			OFF-delay	[Red]	200 ms
		COARSE	ON			ON-delay	[Red]			500 ms		
	Color mode	Consistent-ON	FINE			non	[Red]			100 ms		
			COARSE			OFF-delay	[Red]			200 ms		
		Inconsistent-ON	FINE			ON-delay	[Red]			500 ms		
COARSE	non	[Red]	100 ms									

- Notes: 1) In Mark mode, L-ON / D-ON is automatically set in the sensor. For example, with 2-level teaching, press the ON key at the targeted mark and press the OFF key at the base (non-mark area). When doing so, the operator does not have to consider L-ON / D-ON.
 2) Sensing accuracy can be set to either FINE (standard) or COARSE.
 3) The percent display is only enabled in mark mode.
 4) ECO mode is a function that reduces power consumption by turning off the digital display in the event that no button operations are made for a predetermined time (approx. 10 sec. or more) in RUN mode. Press any button to turn the digital display on again.
 5) The turn mode is a function that reverses the digital display making it easily to be viewed in the event that the sensor installation renders the display up-side-down.
 * Default setting: D-code = "0004".

Super simple teaching

Press the ON button at the targeted mark.

Here is an example of the most basic setting method "2-level teaching".

Mode selection Press MODE key and select TEACH mode.

Teaching

- Align the spot on the mark and press the ON key.
- Align the spot onto the base (non-mark area) and press the OFF key.

* The ① ② order can be reversed.

Sensing Teaching complete. The optimal LED is automatically selected and the sensor automatically returns to RUN mode.

Other teaching methods

- Full-auto teaching: In Mark mode, teaching is effective without stopping the sensing object.
- 1-level teaching: In Color mode, the color detected is aligned by the spot and teaching is effective.

Compact design for significant space savings

High precision sensing and multiple functions are all packed in a compact W57 × D24 × H38 mm W2.244 × D0.945 × H1.496 in body. Cable and plug-in connector types are available depending on the equipment used. These sensors can be easily introduced to existing facilities.



External teaching possible

Teaching is possible through external input using an operation panel or touch panel even on hard-to-reach color mark sensors located inside an equipment. Also, models can be interchanged easily.

Mark mode
2-level teaching and full-auto teaching possible

Color mode
1-level teaching possible



Key lock function

The key lock function enables input operation control that prevents mistaken changes in the sensor settings. Other detailed settings include "RUN adjust", allowing threshold value adjustment only, and "RUN teaching", allowing teaching operation only. If the sensor is set to "RUN adjust" or "RUN teaching", adjustment and teaching are possible having the sensor remained in RUN mode.

- FIBER SENSORS
- LASER SENSORS
- PHOTOELECTRIC SENSORS
- MICRO PHOTOELECTRIC SENSORS
- AREA SENSORS
- LIGHT CURTAINS / SAFETY COMPONENTS
- PRESSURE / FLOW SENSORS
- INDUCTIVE PROXIMITY SENSORS
- PARTICULAR USE SENSORS
- SENSOR OPTIONS
- SIMPLE WIRE-SAVING UNITS
- WIRE-SAVING SYSTEMS
- MEASUREMENT SENSORS
- STATIC ELECTRICITY PREVENTION DEVICES
- LASER MARKERS
- PLC
- HUMAN MACHINE INTERFACES
- ENERGY CONSUMPTION VISUALIZATION COMPONENTS
- FA COMPONENTS
- MACHINE VISION SYSTEMS
- UV CURING SYSTEMS
- Selection Guide
- Wafer Detection
- Liquid Leak Detection
- Liquid Level Detection
- Water Detection
- Color Mark Detection
- Hot Melt Glue Detection
- Ultrasonic
- Small / Slim Object Detection
- Obstacle Detection
- Other Products

LX-100

FZ-10

FIBER SENSORS

LASER SENSORS

PHOTO-ELECTRIC SENSORS

MICRO PHOTO-ELECTRIC SENSORS

AREA SENSORS

LIGHT CURTAINS / SAFETY COMPONENTS

PRESSURE / FLOW SENSORS

INDUCTIVE PROXIMITY SENSORS

PARTICULAR USE SENSORS

SENSOR OPTIONS

SIMPLE WIRE-SAVING UNITS

WIRE-SAVING SYSTEMS

MEASUREMENT SENSORS

STATIC ELECTRICITY PREVENTION DEVICES

LASER MARKERS

PLC

HUMAN MACHINE INTERFACES

ENERGY CONSUMPTION VISUALIZATION COMPONENTS

FA COMPONENTS

MACHINE VISION SYSTEMS

UV CURING SYSTEMS

Selection Guide

Wafer Detection

Liquid Leak Detection

Liquid Level Detection

Water Detection

Color Mark Detection

Hot Melt Glue Detection

Ultrasonic

Small / Slim Object Detection

Obstacle Detection

Other Products

ORDER GUIDE

Sensors Mating cable is not supplied with the plug-in connector type. Please order it separately.

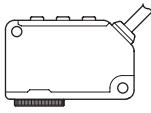
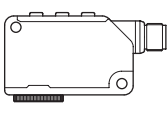
Type	Appearance	Model No.	Output	Sensing range
Cable type		LX-101	NPN open-collector transistor	10 ±3 mm 0.394 ±0.118 in
		LX-101-P	PNP open-collector transistor	
Plug-in connector type		LX-101-Z	NPN open-collector transistor	
		LX-101-P-Z	PNP open-collector transistor	

Mating cables for plug-in connector type sensor Mating cable is not supplied with the plug-in connector type sensor. Please order it separately.

Type	Model No.	Description
Straight	CN-24B-C2	Length: 2 m 6.562 ft
	CN-24B-C5	Length: 5 m 16.404 ft
Elbow	CN-24BL-C2	Length: 2 m 6.562 ft
	CN-24BL-C5	Length: 5 m 16.404 ft

0.34 mm² 4-core cabtyre cable, with connector on one end
Cable outer diameter: ø5 mm ø0.197 in

Mating cables for plug-in connector type sensor

- CN-24B-C2
- CN-24B-C5
- CN-24BL-C2
- CN-24BL-C5

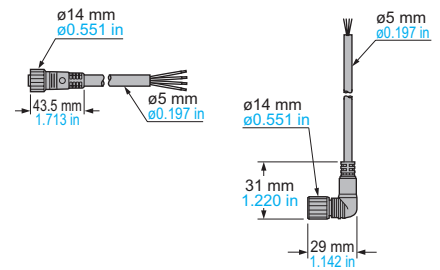

OPTIONS

Type	Model No.	Description
Sensor mounting bracket	MS-LX-1	Mounting bracket made for LX-100 series applicable for various kinds of installations
	MS-LX-2	

Sensor mounting bracket

• MS-LX-1

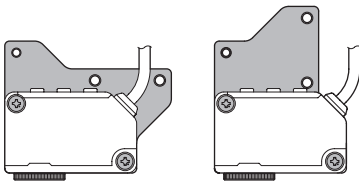

Two M4 (length 28 mm 1.102 in) screws with washers are attached.

• MS-LX-2

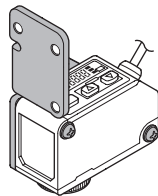

Two M4 (length 30 mm 1.181 in) screws with washers are attached.

SPECIFICATIONS

Item	Model No.	Type	Cable type	Plug-in connector type
		NPN output	LX-101	LX-101-Z
		PNP output	LX-101-P	LX-101-P-Z
Sensing range		10 ±3 mm 0.394 ±0.118 in		
Spot size		1 × 5 mm 0.039 × 0.197 in (at 10 mm 0.394 in setting distance)		
Supply voltage		12 to 24 V DC ±10 % Ripple P-P 10 % or less		
Current consumption		Normal mode: 750 mW or less (Current consumption 30 mA or less at 24 V supply voltage) ECO mode: 600 mW or less (Current consumption 25 mA or less at 24 V supply voltage)		
Output 1 (OUT)	<p><NPN output type> NPN open-collector transistor</p> <ul style="list-style-type: none"> Maximum sink current: 50 mA Applied voltage: 30 V DC or less (between output and 0 V) Residual voltage: 1.5 V or less (at 50 mA sink current) <p><PNP output type> PNP open-collector transistor</p> <ul style="list-style-type: none"> Maximum source current: 50 mA Applied voltage: 30 V DC or less (between output and +V) Residual voltage: 1.5 V or less (at 50 mA source current) 		<p><NPN output type> NPN open-collector transistor</p> <ul style="list-style-type: none"> Maximum sink current: 100 mA Applied voltage: 30 V DC or less (between output and 0 V) Residual voltage: 1.5 V or less (at 100 mA sink current) <p><PNP output type> PNP open-collector transistor</p> <ul style="list-style-type: none"> Maximum source current: 100 mA Applied voltage: 30 V DC or less (between output and +V) Residual voltage: 1.5 V or less (at 100 mA source current) 	
	Short-circuit protection	Incorporated		
Output operation		Mark mode: Light-ON / Dark-ON (Auto-setting on teaching), Color mode: Consistent-ON / Inconsistent-ON (Setting on teaching)		
Output 2 (OUT)	<p><NPN output type> NPN open-collector transistor</p> <ul style="list-style-type: none"> Maximum sink current: 50 mA Applied voltage: 30 V DC or less (between output and 0 V) Residual voltage: 1.5 V or less (at 50 mA sink current) <p><PNP output type> PNP open-collector transistor</p> <ul style="list-style-type: none"> Maximum source current: 50 mA Applied voltage: 30 V DC or less (between output and +V) Residual voltage: 1.5 V or less (at 50 mA source current) 		_____	
	Short-circuit protection	Incorporated		
Output operation		Inverted operation of the output 1		
Response time		Mark mode: 45 µs or less, Color mode: 150 µs or less		
Teaching input		<p><NPN output type> NPN non-contact input</p> <ul style="list-style-type: none"> Signal condition: High... +5 V to +V, or open Low... 0 to +2 V (source current: 0.5 mA or less) Input impedance: 10 kΩ approx. 	<p><PNP output type> PNP non-contact input</p> <ul style="list-style-type: none"> Signal condition: High... +4 V to +V (sink current: 3 mA or less) Low... 0 to +0.6 V, or open Input impedance: 10 kΩ approx. 	
Digital display		4-digit red LED display		
Sensitivity setting		Mark mode: 2-level teaching / Full-auto teaching, Color mode: 1-level teaching		
Fine sensitivity adjustment function		Incorporated		
Timer function		Incorporated with variable ON-delay / OFF-delay timer, switchable either effective or ineffective (Timer period: 1 to 500 ms, 9 levels variable)		
Environmental resistance	Protection	IP67 (IEC)		
	Ambient temperature	-10 to +55 °C +14 to +131 °F (No dew condensation or icing allowed), Storage: -20 to +70 °C -4 to +158 °F		
	Ambient humidity	35 to 85 % RH, Storage: 35 to 85 % RH		
	Ambient illuminance	Incandescent light: 3,000 lx at the light-receiving face		
	Voltage withstandability	1,000 V AC for one min. between all supply terminals connected together and enclosure		
	Vibration resistance	10 to 500 Hz frequency, 3.0 mm 0.118 in amplitude (max. 20 G) in X, Y and Z directions for two hours each		
Shock resistance		500 m/s ² acceleration (50 G approx.) in X, Y and Z directions for three times each		
Emitting element		Combined Red / Green / Blue LEDs (Peak emission wavelength: 640 nm 0.025 mil / 525 nm 0.021 mil / 470 nm 0.019 mil)		
Material		Enclosure: PBT, Display cover: Polycarbonate, Operation buttons: Silicone rubber, Lens: Glass, Lens holder: Aluminum		
Cable		0.34 mm ² 5-core cabtyre cable, 2 m 6.562 ft long	(Note 2)	
Cable extension		Extension up to total 100 m 328.084 ft is possible with 0.3 mm ² , or more, cable.		
Weight		Net weight: 120 g approx., Gross weight: 180 g approx.	Net weight: 55 g approx., Gross weight: 120 g approx.	
Accessory		M4 (length 30 mm 1.181 in) screw with washers: 2 pcs.		

Notes: 1) Where measurement conditions have not been specified precisely, the conditions used were an ambient temperature of +23 °C **+73.4 °F**.

2) Mating cable is not supplied with the plug-in connector type. Please order it separately.

FIBER
SENSORSLASER
SENSORSPHOTO-
ELECTRIC
SENSORSMICRO
PHOTO-
ELECTRIC
SENSORSAREA
SENSORSLIGHT
CURTAINS /
SAFETY
COMPONENTSPRESSURE /
FLOW
SENSORSINDUCTIVE
PROXIMITY
SENSORSPARTICULAR
USE
SENSORSSENSOR
OPTIONSSIMPLE
WIRE-SAVING
UNITSWIRE-SAVING
SYSTEMSMEASURE-
MENT
SENSORSSTATIC
ELECTRICITY
PREVENTION
DEVICESLASER
MARKERS

PLC

HUMAN
MACHINE
INTERFACESENERGY
CONSUMPTION
VISUALIZATION
COMPONENTSFA
COMPONENTSMACHINE
VISION
SYSTEMSUV
CURING
SYSTEMSSelection
GuideWafer
DetectionLiquid Leak
DetectionLiquid Level
DetectionWater
DetectionColor Mark
DetectionHot Melt Glue
Detection

Ultrasonic

Small / Slim
Object
DetectionObstacle
DetectionOther
Products**LX-100****FZ-10**

- FIBER SENSORS
- LASER SENSORS
- PHOTO-ELECTRIC SENSORS
- MICRO PHOTO-ELECTRIC SENSORS
- AREA SENSORS
- LIGHT CURTAINS / SAFETY COMPONENTS
- PRESSURE / FLOW SENSORS
- INDUCTIVE PROXIMITY SENSORS
- PARTICULAR USE SENSORS
- SENSOR OPTIONS
- SIMPLE WIRE-SAVING UNITS
- WIRE-SAVING SYSTEMS
- MEASURE-MENT SENSORS
- STATIC ELECTRICITY PREVENTION DEVICES
- LASER MARKERS
- PLC
- HUMAN MACHINE INTERFACES
- ENERGY CONSUMPTION VISUALIZATION COMPONENTS
- FA COMPONENTS
- MACHINE VISION SYSTEMS
- UV CURING SYSTEMS
- Selection Guide
- Wafer Detection
- Liquid Leak Detection
- Liquid Level Detection
- Water Detection
- Color Mark Detection
- Hot Melt Glue Detection
- Ultrasonic
- Small / Slim Object Detection
- Obstacle Detection
- Other Products

I/O CIRCUIT AND WIRING DIAGRAMS

LX-101(-Z) NPN output type

I/O circuit diagram

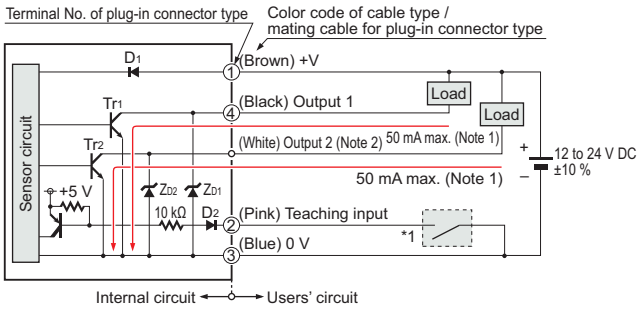

Notes: 1) The current of the plug-in connector type LX-101-Z is 100 mA max.
2) The output 2 is not incorporated to the plug-in connector type LX-101-Z.

* 1

Non-voltage contact or NPN transistor

- Teaching input
- High: 5 V to +V, or open
- Low: 0 to +2 V (source current: 0.5 mA or less)
- Teaching is carried out at the Low.

Symbols ... D1, D2 : Reverse supply polarity protection diode
Zd1, Zd2: Surge absorption zener diode
Tr1, Tr2 : NPN output transistor

LX-101-P(-Z) PNP output type

I/O circuit diagram

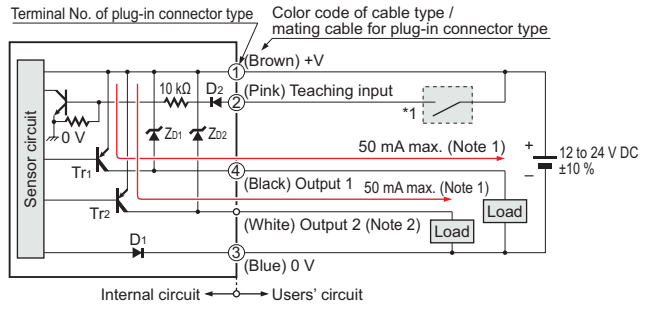

Notes: 1) The current of the plug-in connector type LX-101-P-Z is 100 mA max.
2) The output 2 is not incorporated to the plug-in connector type LX-101-P-Z.

* 1

Non-voltage contact or PNP transistor

- Teaching input
- High: +4 V to +V (sink current: 3 mA or less)
- Low: 0 to +0.6 V, or open
- Teaching is carried out at the High.

Symbols ... D1, D2 : Reverse supply polarity protection diode
Zd1, Zd2: Surge absorption zener diode
Tr1, Tr2 : PNP output transistor

Connector pin layout of plug-in connector type

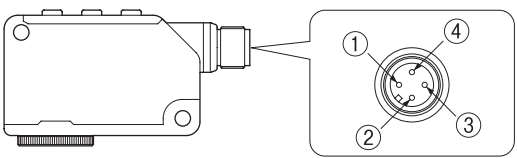

Connector pin No.	Description
①	+V
②	Teaching input
③	0 V
④	Output

SPOT SIZE CHARACTERISTICS (TYPICAL)

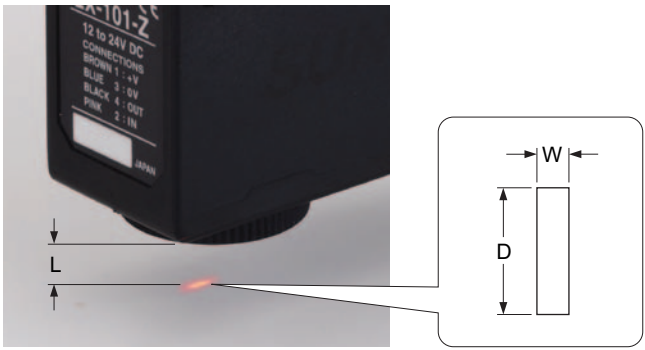

(Unit: mm in)

Setting distance L (Note 1)	Spot size (Note 2)	
	Width (W)	Length (D)
7	0.276	2.0 0.079 / 5.5 0.217
8	0.315	1.7 0.067 / 5.5 0.217
9	0.354	1.2 0.047 / 5.3 0.209
10	0.394	1.0 0.039 / 5.0 0.197
11	0.433	1.3 0.051 / 5.0 0.197
12	0.472	1.5 0.059 / 5.0 0.197
13	0.512	2.0 0.079 / 5.0 0.197

Notes: 1) Setting distance "L" represents the distance from the lens surface to the sensing object.
2) Examples only meant for use as a guideline.

PRECAUTIONS FOR PROPER USE

Refer to p.1458~ for general precautions.

FIBER
SENSORSLASER
SENSORSPHOTO-
ELECTRIC
SENSORSMICRO
PHOTO-
ELECTRIC
SENSORSAREA
SENSORSLIGHT
CURTAINS /
SAFETY
COMPONENTSPRESSURE /
FLOW
SENSORSINDUCTIVE
PROXIMITY
SENSORSPARTICULAR
USE
SENSORSSENSOR
OPTIONSSIMPLE
WIRE-SAVING
UNITSWIRE-SAVING
SYSTEMSMEASURE-
MENT
SENSORSSTATIC
ELECTRICITY
PREVENTION
DEVICESLASER
MARKERS

PLC

HUMAN
MACHINE
INTERFACESENERGY
CONSUMPTION
VISUALIZATION
COMPONENTSFA
COMPONENTSMACHINE
VISION
SYSTEMSUV
CURING
SYSTEMSSelection
GuideWafer
DetectionLiquid Leak
DetectionLiquid Level
DetectionWater
DetectionColor Mark
DetectionHot Melt Glue
Detection

Ultrasonic

Small / Slim
Object DetectionObstacle
DetectionOther
Products**LX-100****FZ-10**

- Never use this product as a sensing device for personnel protection.
- In case of using sensing devices for personnel protection, use products which meet laws and standards, such as OSHA, ANSI or IEC etc., for personnel protection applicable in each region or country.

Mounting

- Care must be taken regarding the sensor mounting direction with respect to the object's direction of movement.

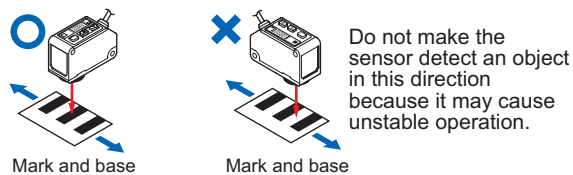

- The tightening torque should be 0.8 N·m or less.

Sensing glossy object

- Objects with a glossy surface have a large amount of specular reflection particles that may destabilize sensing. In such a case, by slightly tilting the sensor's beam axis, this specular reflection can be reduced rendering sensing more stable.
- If the surface of the sensing object has a shine, mount the sensor inclining approx. 10 to 15 degrees against the sensing object.

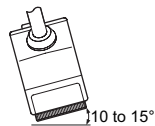
**Wiring**

- Make sure to carry out wiring in the power supply off condition.
- Take care that wrong wiring will damage the sensor.
- Verify that the supply voltage variation is within the rating.
- Take care that if a voltage exceeding the rated range is applied, or if an AC power supply is directly connected, the sensor may get burnt or damaged.
- In case noise generating equipment (switching regulator, inverter motor, etc.) is used in the vicinity of this product, connect the frame ground (F.G.) terminal of the equipment to an actual ground.
- If power is supplied from a commercial switching regulator, ensure that the frame ground (F.G.) terminal of the power supply is connected to an actual ground.
- Do not use during the initial transient time (0.5 sec.) after the power supply is switched on.
- Take care that short-circuit of the load or wrong wiring may burn or damage the sensor.
- Do not run the wires together with high-voltage lines or power lines or put them in the same raceway. This can cause malfunction due to induction.
- Extension up to total 100 m is possible with 0.3 mm², or more, cable. However, in order to reduce noise, make the wiring as short as possible.

LIST OF PROMODE SETTING ITEMS

• Before performing teaching or each detail setting, perform the setting of either mark mode or color mode with mark / color mode setting of NAVI mode.

NAVI mode

RUN Run

At mark mode setting: Indicates the absolute value of emitting amount. It is possible to indicate the relative value (percent value) against threshold value.
At color mode setting: Indicates color matching degree with relative value.

TEACH Teaching

At mark mode setting: Sets the threshold value by '2-level teaching' or 'full-auto teaching'.
At color mode setting: Sets the threshold value by '1-level teaching'.

ADJ Adjust

At mark mode setting: Allows fine adjustment of the threshold value.
At color mode setting: Allows adjustment of sensing tolerance value.

COLOR Mark / Color mode setting

Sets mark mode or color mode.

TIMER Timer operation setting

Configures operation of the timer.

PRO PRO

Allows various detailed settings to be configured.

PROMode • For selecting a setting item, press 'ON key'. For confirming each selected setting item, press 'OFF / ENTER key'. After confirming setting, the digital display flashes. For canceling setting, press 'MODE key'.

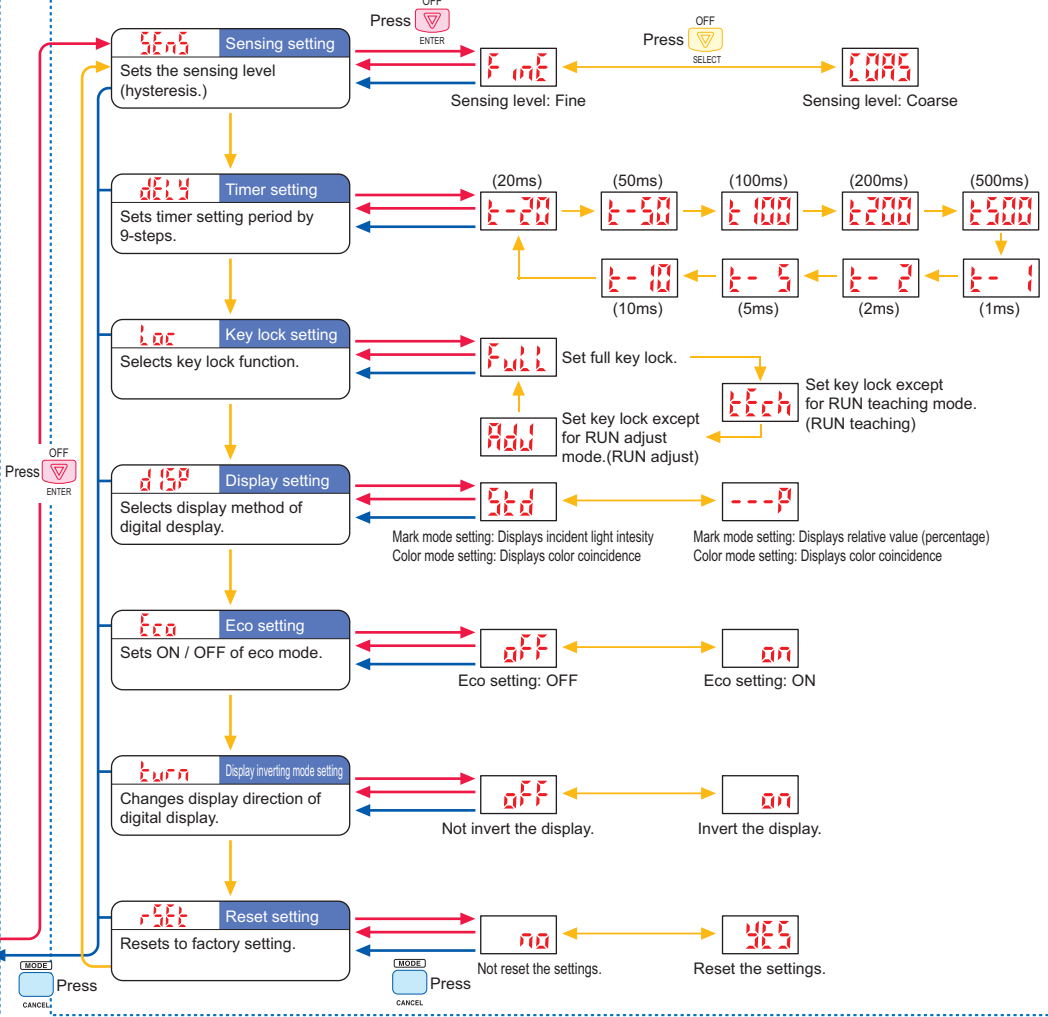

- Selection Guide
- Wafer Detection
- Liquid Leak Detection
- Liquid Level Detection
- Water Detection
- Color Mark Detection
- Hot Melt Glue Detection
- Ultrasonic
- Small / Slim Object Detection
- Obstacle Detection
- Other Products

