



Chipsmall Limited consists of a professional team with an average of over 10 year of expertise in the distribution of electronic components. Based in Hongkong, we have already established firm and mutual-benefit business relationships with customers from,Europe,America and south Asia,supplying obsolete and hard-to-find components to meet their specific needs.

With the principle of “Quality Parts,Customers Priority,Honest Operation,and Considerate Service”,our business mainly focus on the distribution of electronic components. Line cards we deal with include Microchip,ALPS,ROHM,Xilinx,Pulse,ON,Everlight and Freescale. Main products comprise IC,Modules,Potentiometer,IC Socket,Relay,Connector.Our parts cover such applications as commercial,industrial, and automotives areas.

We are looking forward to setting up business relationship with you and hope to provide you with the best service and solution. Let us make a better world for our industry!



Contact us

Tel: +86-755-8981 8866 Fax: +86-755-8427 6832

Email & Skype: info@chipsmall.com Web: www.chipsmall.com

Address: A1208, Overseas Decoration Building, #122 Zhenhua RD., Futian, Shenzhen, China



Current Transducer LXSR series

$I_{PN} = 6, 15, 25 A$

Ref: LXSR 6-NPS, LXSR 15-NPS, LXSR 25-NPS

For the electronic measurement of current: DC, AC, pulsed..., with galvanic separation between the primary and the secondary circuit.



Features

- Closed loop multi-range current transducer
- Voltage output
- Unipolar supply voltage
- Compact design for PCB mounting.

Advantages

- Very low offset drift
- Very good dv/dt immunity
- LTSR footprint compatible
- Reference pin with two modes: Ref IN and Ref OUT
- Extended measuring range for unipolar measurement.

Applications

- AC variable speed and servo motor drives
- Static converters for DC motor drives
- Battery supplied applications
- Uninterruptible Power Supplies (UPS)
- Switched Mode Power Supplies (SMPS)
- Power supplies for welding applications
- Solar inverters.

Standards

- IEC 61800-1: 1997
- IEC 61800-2: 2015
- IEC 61800-3: 2004
- IEC 61800-5-1: 2007
- IEC 62109-1: 2010
- IEC 62477-1: 2012
- UL 508:2013

Application Domain

- Industrial.

Absolute maximum ratings

| Parameter | Symbol | Unit | Value |
|-----------------------------------------|----------------|------|---------------------|
| Maximum supply voltage | $U_{C \max}$ | V | 7 |
| Maximum primary conductor temperature | $T_{B \max}$ | °C | 110 |
| Maximum primary current | $I_{P \max}$ | A | $20 \times I_{P N}$ |
| Maximum electrostatic discharge voltage | $U_{ESD \max}$ | kV | 4 |

Stresses above these ratings may cause permanent damage. Exposure to absolute maximum ratings for extended periods may degrade reliability.

UL 508: Ratings and assumptions of certification

File # E189713 Volume: 2 Section: 11

Standards

- CSA C22.2 NO. 14-10 INDUSTRIAL CONTROL EQUIPMENT - Date 2011/08/01
- UL 508 STANDARD FOR INDUSTRIAL CONTROL EQUIPMENT - Date 2013

Ratings

| Parameter | Symbol | Unit | Value |
|---------------------------------|-----------|---------|--------------------------------------|
| Primary involved potential | | V AC/DC | 600 |
| Max surrounding air temperature | T_A | °C | 105 |
| Primary current | I_P | A | According to series primary currents |
| Secondary supply voltage | U_C | V DC | 7 |
| Output voltage | V_{out} | V | 0 to 5 |

Conditions of acceptability

When installed in the end-use equipment, consideration shall be given to the following:

- 1 - These devices must be mounted in a suitable end-use enclosure.
- 2 - The terminals have not been evaluated for field wiring.
- 3 - The LES, LESR, LKSR, LPSR, LXS and LXSR Series shall be used in a pollution degree 2 environment or better.
- 4 - Low voltage circuits are intended to be powered by a circuit derived from an isolating source (such as a transformer, optical isolator, limiting impedance or electro-mechanical relay) and having no direct connection back to the primary circuit (other than through the grounding means).
- 5 - These devices are intended to be mounted on the printed wiring board of the end-use equipment (with a minimum CTI of 100).
- 6 - LES, LESR, LKSR and LPSR Series: based on results of temperature tests, in the end-use application, a maximum of 110°C cannot be exceeded on the primary jumper.

Marking

Only those products bearing the UL or UR Mark should be considered to be Listed or Recognized and covered under UL's Follow-Up Service. Always look for the Mark on the product.

Insulation coordination

| Parameter | Symbol | Unit | Value | Comment |
|-----------------------------------------------------|-------------|------------|-----------------------|---------------------------------------------------------------------|
| RMS voltage for AC insulation test, 50 Hz, 1 min | U_d | kV | 4.3 | |
| Impulse withstand voltage 1.2/50 μ s | \hat{U}_W | kV | 8 | |
| Insulation resistance | R_{INS} | G Ω | 18 | measured at 500 V DC |
| Partial discharge RMS test voltage ($q_m < 10$ pC) | U_t | kV | 1.65 | |
| Clearance (pri. - sec.) | d_{Cl} | mm | | See dimensions drawing on page 19 |
| Creepage distance (pri. - sec.) | d_{Cp} | | | |
| Case material | - | - | V0 according to UL 94 | |
| Comparative tracking index | CTI | | 600 | |
| Application example | | V | 300 V CAT III, PD2 | Reinforced insulation, non uniform field according to IEC 61800-5-1 |
| Application example | | V | 600 V CAT III, PD2 | Basic insulation, non uniform field according to IEC 61800-5-1 |

Environmental and mechanical characteristics

| Parameter | Symbol | Unit | Min | Typ | Max | Comment |
|-------------------------------|--------|--------------|-----|-----|-----|---------|
| Ambient operating temperature | T_A | $^{\circ}$ C | -40 | | 105 | |
| Ambient storage temperature | T_S | $^{\circ}$ C | -55 | | 125 | |
| Mass | m | g | | 10 | | |

Electrical data LXSR 6-NP

At $T_A = 25\text{ °C}$, $U_C = +5\text{ V}$, $N_P = 1$ turn, $R_L = 10\text{ k}\Omega$ internal reference, unless otherwise noted (see Definition of typical, minimum and maximum values paragraph in page 18).

| Parameter | Symbol | Unit | Min | Typ | Max | Comment |
|-------------------------------------------------------------------------------|--------------|-------------------------------|-------|-----------------------------------|-----------------------------------|--------------------------------------------------------------|
| Primary nominal RMS current | I_{PN} | A | | 6 | | Apply derating according to fig. 21 |
| Primary current, measuring range | I_{PM} | A | -20 | | 20 | |
| Number of primary turns | N_P | | | 1, 2, 3 | | |
| Supply voltage | U_C | V | 4.75 | 5 | 5.25 | |
| Current consumption | I_C | mA | | $17 + \frac{I_p(\text{mA})}{N_s}$ | $20 + \frac{I_p(\text{mA})}{N_s}$ | $N_s = 2000$ turns |
| Reference voltage @ $I_p = 0\text{ A}$ | V_{ref} | V | 2.485 | 2.5 | 2.515 | Internal reference |
| External reference voltage | V_{ref} | V | 0.5 | | 2.75 | |
| Output voltage | V_{out} | V | 0.25 | | 4.75 | with $U_C = +5\text{ V}$ |
| Output voltage @ $I_p = 0\text{ A}$ | V_{out} | V | | V_{ref} | | |
| Electrical offset voltage | V_{OE} | mV | -5 | | 5 | 100 % tested $V_{out} - V_{ref}$ |
| Electrical offset current referred to primary | I_{OE} | mA | -48 | | 48 | 100 % tested |
| Temperature coefficient of V_{ref} @ $I_p = 0\text{ A}$ | TCV_{ref} | ppm/K | | | ± 70 | Internal reference |
| Temperature coefficient of V_{out} @ $I_p = 0\text{ A}$ | TCV_{out} | ppm/K | | | ± 14 | ppm/K of 2.5 V -40 °C ... 105 °C |
| Theoretical sensitivity | G_{th} | mV/A | | 104.2 | | $625\text{ mV}/I_{PN}$ |
| Sensitivity error | ϵ_G | % | -0.2 | | 0.2 | 100 % tested |
| Temperature coefficient of G | TCG | ppm/K | | | ± 45 | -40 °C ... 105 °C |
| Linearity error | ϵ_L | % of I_{PN} | -0.1 | | 0.1 | |
| Magnetic offset current ($10 \times I_{PN}$) referred to primary | I_{OM} | mA | -25 | | 25 | |
| Output RMS voltage noise spectral density 100 ... 100 kHz referred to primary | e_{no} | $\mu\text{V}/\text{Hz}^{1/2}$ | | 7 | | |
| Output voltage noise DC ... 10 kHz DC ... 100 kHz DC ... 1 MHz | V_{no} | mVpp | | 11.1 13.2 13.3 | | |
| Reaction time @ 10 % of I_{PN} | t_{ra} | μs | | | 0.3 | $R_L = 1\text{ k}\Omega$, $di/dt = 50\text{ A}/\mu\text{s}$ |
| Step response time to 90 % of I_{PN} | t_r | μs | | | 0.4 | $R_L = 1\text{ k}\Omega$, $di/dt = 50\text{ A}/\mu\text{s}$ |
| Frequency bandwidth ($\pm 1\text{ dB}$) | BW | kHz | 300 | | | $R_L = 1\text{ k}\Omega$ |
| Overall accuracy | X_G | % of I_{PN} | | | 1.25 | |
| Overall accuracy @ $T_A = 85\text{ °C}$ (105 °C) | X_G | % of I_{PN} | | | 1.25 (1.5) | |
| Accuracy | X | % of I_{PN} | | | 0.5 | |
| Accuracy @ $T_A = 85\text{ °C}$ (105 °C) | X | % of I_{PN} | | | 0.75 (1) | |

Electrical data LXSR 15-NPS

At $T_A = 25\text{ °C}$, $U_C = +5\text{ V}$, $N_P = 1\text{ turn}$, $R_L = 10\text{ k}\Omega$ internal reference, unless otherwise noted (see Min, Max, typical definition paragraph in page 18).

| Parameter | Symbol | Unit | Min | Typ | Max | Comment |
|-------------------------------------------------------------------------|-----------------|-------------------------------|-------|-----------------------------------|-----------------------------------|--------------------------------------------------------------|
| Primary nominal RMS current | I_{PN} | A | | 15 | | Apply derating according to fig. 17 |
| Primary current, measuring range | I_{PM} | A | -51 | | 51 | |
| Number of primary turns | N_P | | | 1, 2, 3 | | |
| Supply voltage | U_C | V | 4.75 | 5 | 5.25 | |
| Current consumption | I_C | mA | | $17 + \frac{I_p(\text{mA})}{N_s}$ | $20 + \frac{I_p(\text{mA})}{N_s}$ | $N_s = 2000\text{ turns}$ |
| Reference voltage @ $I_p = 0\text{ A}$ | V_{ref} | V | 2.485 | 2.5 | 2.515 | Internal reference |
| Output voltage | V_{ref} | V | 0.5 | | 2.75 | |
| Output voltage | V_{out} | V | 0.25 | | 4.75 | with $U_C = +5\text{ V}$ |
| Output voltage @ $I_p = 0\text{ A}$ | V_{out} | V | | V_{ref} | | |
| Electrical offset voltage | V_{OE} | mV | -1.75 | | 1.75 | 100 % tested $V_{out} - V_{ref}$ |
| Electrical offset current referred to primary | I_{OE} | mA | -42 | | 42 | 100 % tested |
| Temperature coefficient of V_{ref} @ $I_p = 0\text{ A}$ | TCV_{ref} | ppm/K | | | ± 70 | Internal reference |
| Temperature coefficient of V_{out} @ $I_p = 0\text{ A}$ | TCV_{out} | ppm/K | | | ± 6 | ppm/K of 2.5 V -40 °C ... 105 °C |
| Theoretical sensitivity | G_{th} | mV/A | | 41.67 | | $625\text{ mV}/I_{PN}$ |
| Sensitivity error | ε_G | % | -0.2 | | 0.2 | 100 % tested |
| Temperature coefficient of G | TCG | ppm/K | | | ± 45 | -40 °C ... 105 °C |
| Linearity error | ε_L | % of I_{PN} | -0.1 | | 0.1 | |
| Magnetic offset current ($10 \times I_{PN}$) referred to primary | I_{OM} | mA | -45 | | 45 | |
| Output RMS noise current 100 Hz ... 100 kHz | e_{no} | $\mu\text{V}/\text{Hz}^{1/2}$ | | 3.5 | | |
| Output noise voltage DC ... 10 kHz DC ... 100 kHz DC ... 1 MHz | V_{no} | mVpp | | 5 6.1 7.3 | | |
| Reaction time @ 10 % of I_{PN} | t_{ra} | μs | | | 0.3 | $R_L = 1\text{ k}\Omega$, $di/dt = 50\text{ A}/\mu\text{s}$ |
| Step response time to 90 % of I_{PN} | t_r | μs | | | 0.4 | $R_L = 1\text{ k}\Omega$, $di/dt = 50\text{ A}/\mu\text{s}$ |
| Frequency bandwidth ($\pm 3\text{ dB}$) | BW | kHz | 300 | | | $R_L = 1\text{ k}\Omega$ |
| Overall accuracy | X_G | % of I_{PN} | | | 0.75 | |
| Overall accuracy @ $T_A = 85\text{ °C}$ (105 °C) | X_G | % of I_{PN} | | | 0.75 (1) | |
| Accuracy | X | % of I_{PN} | | | 0.5 | |
| Accuracy @ $T_A = 85\text{ °C}$ (105 °C) | X | % of I_{PN} | | | 0.65 (0.75) | |

Electrical data LXSR 25-NPS

At $T_A = 25\text{ °C}$, $U_C = +5\text{ V}$, $N_p = 1\text{ turn}$, $R_L = 10\text{ k}\Omega$ internal reference, unless otherwise noted (see Min, Max, typical definition paragraph in page 18).

| Parameter | Symbol | Unit | Min | Typ | Max | Comment |
|-------------------------------------------------------------------------|--------------|-------------------------------|-------|-----------------------------------|-----------------------------------|--------------------------------------------------------------|
| Primary nominal RMS current | I_{PN} | A | | 25 | | Apply derating according to fig. 18 |
| Primary current, measuring range | I_{PM} | A | -85 | | 85 | |
| Number of primary turns | N_p | | | 1, 2, 3 | | |
| Supply voltage | U_C | V | 4.75 | 5 | 5.25 | |
| Current consumption | I_C | mA | | $17 + \frac{I_s(\text{mA})}{N_s}$ | $20 + \frac{I_s(\text{mA})}{N_s}$ | $N_s = 2000\text{ turns}$ |
| Reference voltage @ $I_p = 0\text{ A}$ | V_{ref} | V | 2.485 | 2.5 | 2.515 | Internal reference |
| Output voltage | V_{ref} | V | 0.5 | | 2.75 | |
| Output voltage | V_{out} | V | 0.25 | | 4.75 | with $U_C = +5\text{ V}$ |
| Output voltage @ $I_p = 0\text{ A}$ | V_{out} | V | | V_{ref} | | |
| Electrical offset voltage | V_{OE} | mV | -1 | | 1 | 100 % tested $V_{out} - V_{ref}$ |
| Electrical offset current referred to primary | I_{OE} | mA | -40 | | 40 | 100 % tested |
| Temperature coefficient of V_{ref} @ $I_p = 0\text{ A}$ | TCV_{ref} | ppm/K | | | ± 70 | Internal reference |
| Temperature coefficient of V_{out} @ $I_p = 0\text{ A}$ | TCV_{out} | ppm/K | | | ± 4 | ppm/K of 2.5 V -40 °C ... 105 °C |
| Theoretical sensitivity | G_{th} | mV/A | | 25 | | $625\text{ mV}I_{PN}$ |
| Sensitivity error | ϵ_G | % | -0.2 | | 0.2 | 100 % tested |
| Temperature coefficient of G | TCG | ppm/K | | | ± 45 | -40 °C ... 105 °C |
| Linearity error | ϵ_L | % of I_{PN} | -0.1 | | 0.1 | |
| Magnetic offset current ($10 \times I_{PN}$) referred to primary | I_{OM} | mA | -60 | | 60 | |
| Output RMS noise current 100 Hz ... 100 kHz | e_{no} | $\mu\text{V}/\text{Hz}^{1/2}$ | | 1.8 | | |
| Output noise voltage DC ... 10 kHz DC ... 100 kHz DC ... 1 MHz | V_{no} | mVpp | | 2.3 4.3 4.5 | | |
| Reaction time @ 10 % of I_{PN} | t_{ra} | μs | | | 0.3 | $R_L = 1\text{ k}\Omega$, $di/dt = 50\text{ A}/\mu\text{s}$ |
| Step response time to 90 % of I_{PN} | t_r | μs | | | 0.4 | $R_L = 1\text{ k}\Omega$, $di/dt = 50\text{ A}/\mu\text{s}$ |
| Frequency bandwidth ($\pm 3\text{ dB}$) | BW | kHz | 300 | | | $R_L = 1\text{ k}\Omega$ |
| Overall accuracy | X_G | % of I_{PN} | | | 0.8 | |
| Overall accuracy @ $T_A = 85\text{ °C}$ (105 °C) | X_G | % of I_{PN} | | | 0.85 (0.9) | |
| Accuracy | X | % of I_{PN} | | | 0.5 | |
| Accuracy @ $T_A = 85\text{ °C}$ (105 °C) | X | % of I_{PN} | | | 0.65 (0.75) | |

Typical performance characteristics LXSR 6-NPS

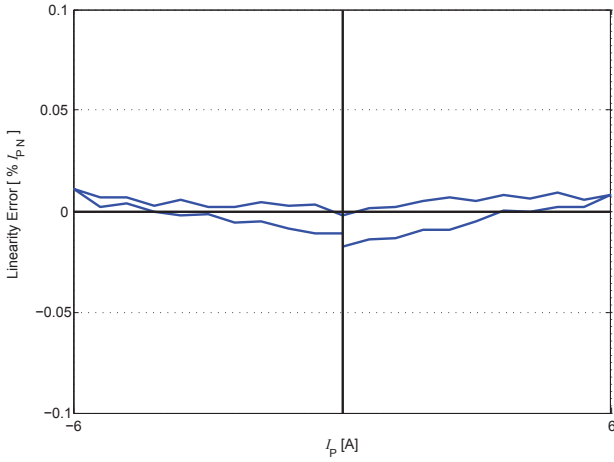

Figure 1: Linearity error

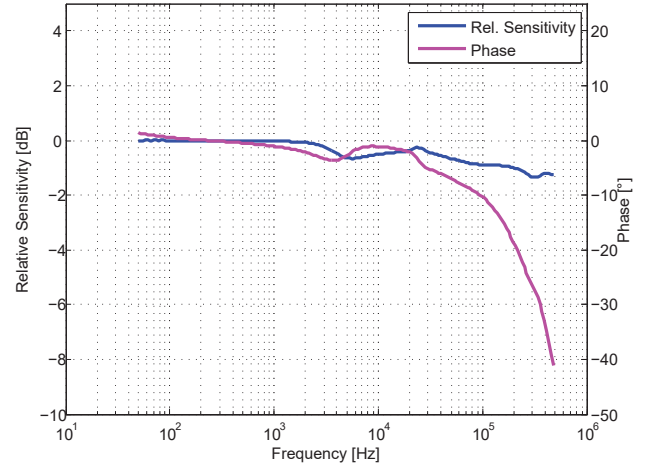

Figure 2: Frequency response

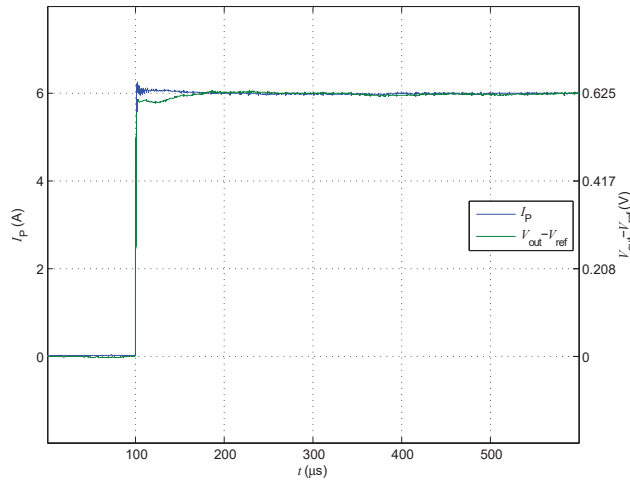

Figure 3: Step response

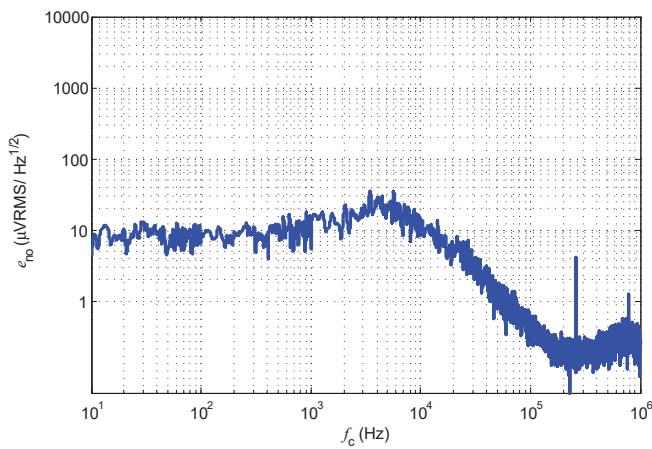

Figure 4: output noise voltage spectral density

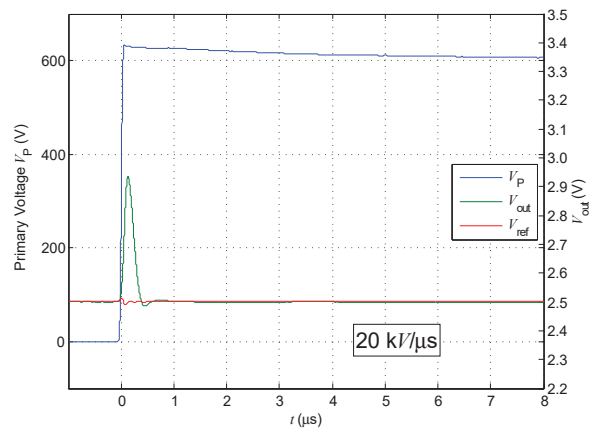

Figure 5: dv/dt

Typical performance characteristics LXSR 15-NPS

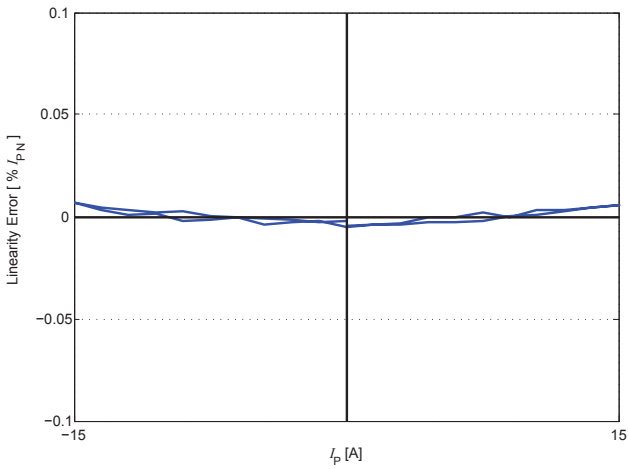

Figure 6: Linearity error

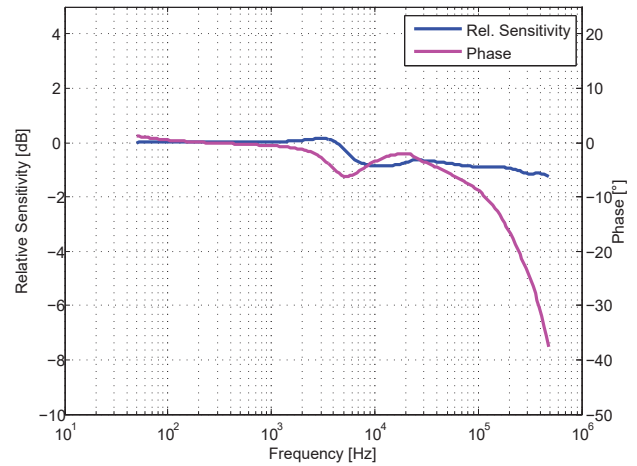

Figure 7: Frequency response

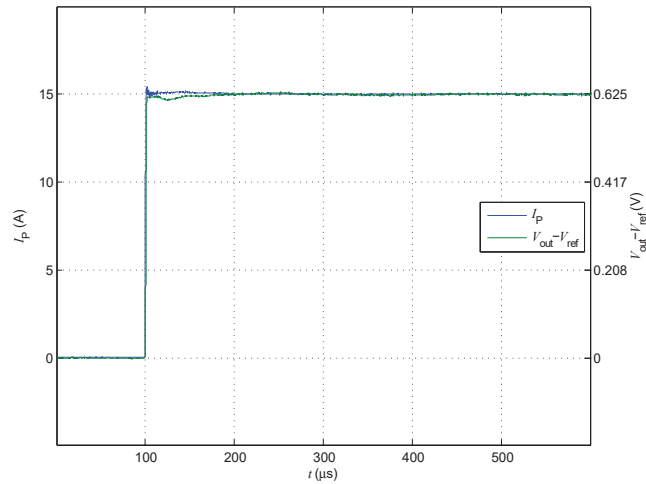

Figure 8: Step response

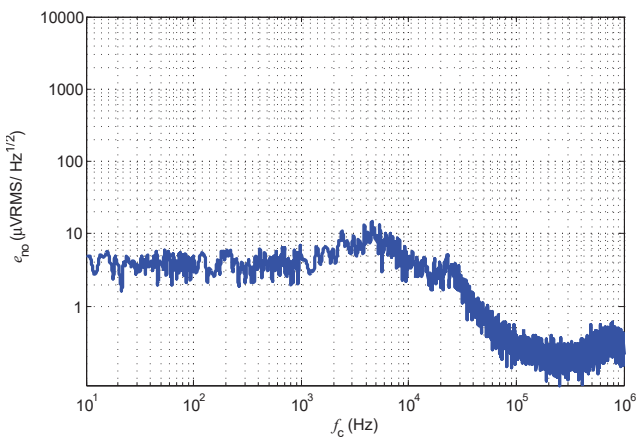

Figure 9: output noise voltage spectral density

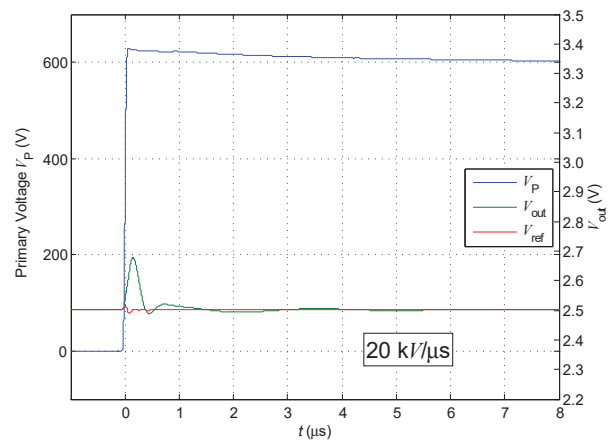

Figure 10: dv/dt

Typical performance characteristics LXSR 25-NPS

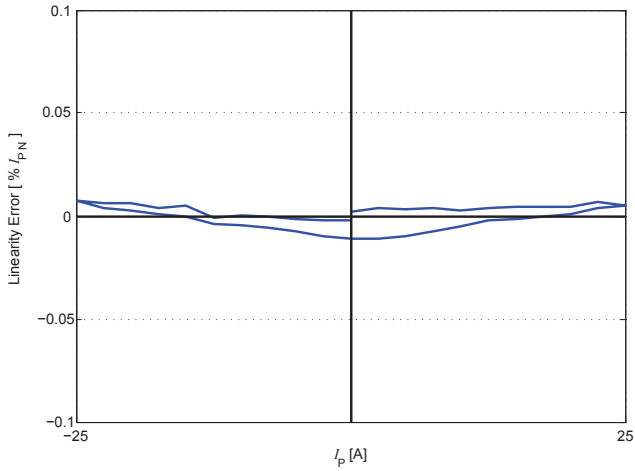

Figure 11: Linearity error

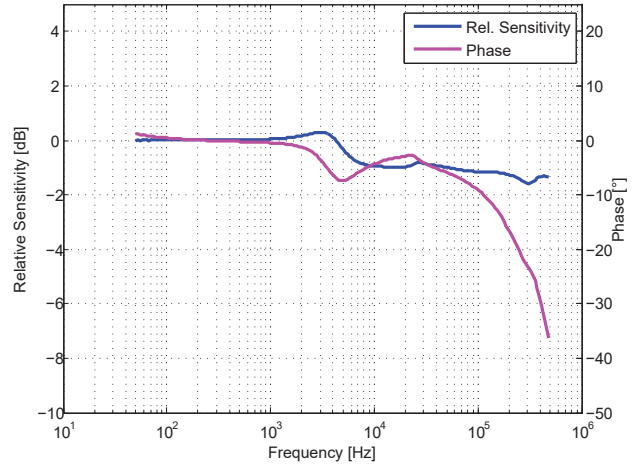

Figure 12: Frequency response

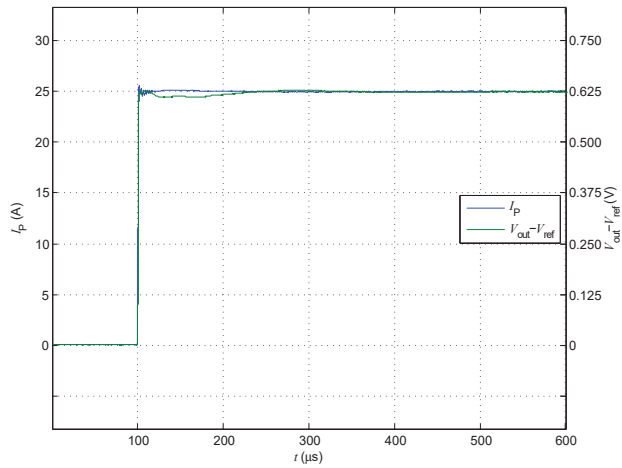

Figure 13: Step response

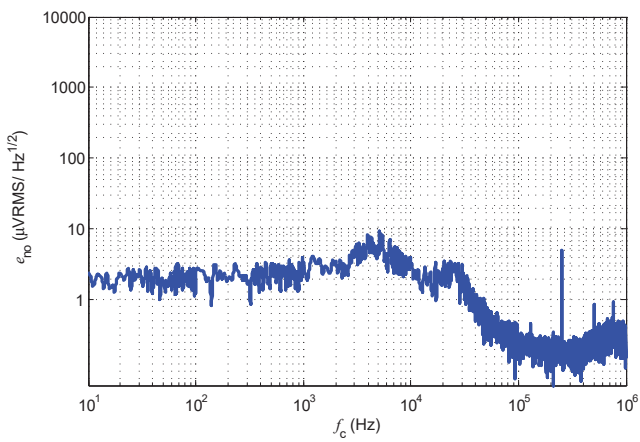

Figure 14: output noise voltage spectral density

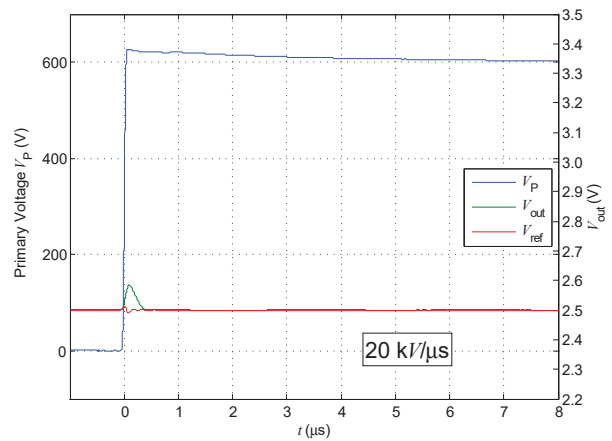

Figure 15: dv/dt

Maximum continuous DC primary current

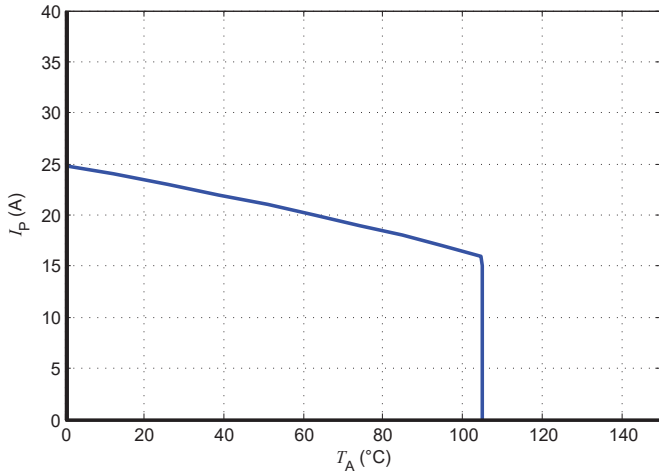

Figure 16: I_p vs T_A for LXSR 6-NPS

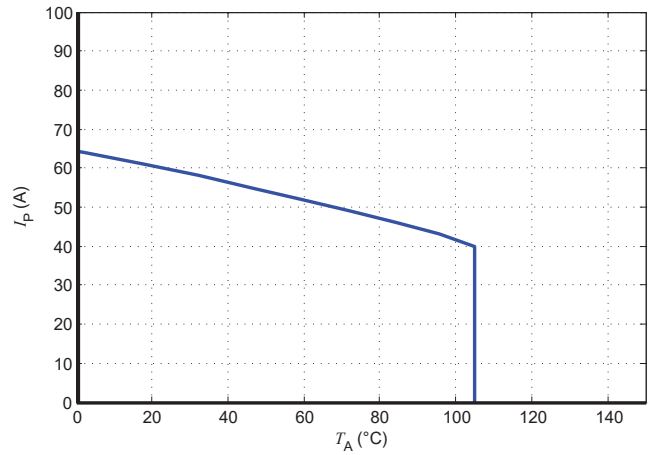

Figure 17: I_p vs T_A for LXSR 15-NPS

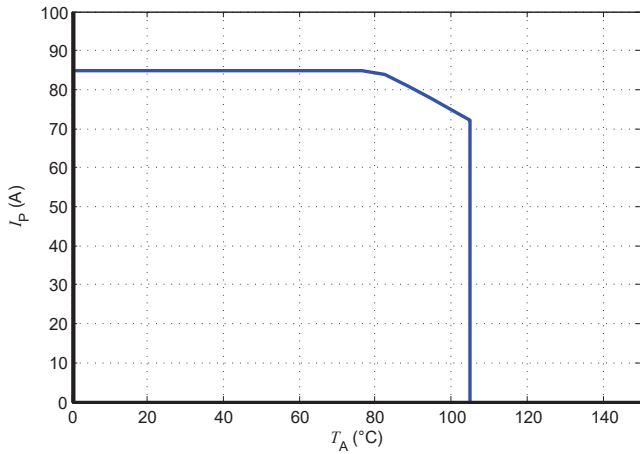

Figure 18: I_p vs T_A for LXSR 25-NPS

The maximum continuous DC primary current plot shows the boundary of the area for which all the following conditions are true:

- $I_p < I_{PM}$
- Junction temperature $T_j < 125$ °C
- Primary conductor temperature < 110 °C
- Max power dissipation of internal resistors $< 0.5 \times$ resistors nominal power

Frequency derating

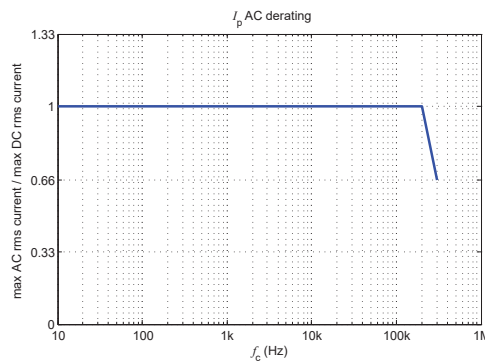

Figure 19: Maximum RMS AC primary current / maximum DC primary current vs frequency

Performance parameters definition

Ampere-turns and amperes

The transducer is sensitive to the primary current linkage Θ_p (also called ampere-turns).

$$\Theta_p = N_p \cdot I_p \text{ (At)}$$

Where N_p is the number of primary turn (depending on the connection of the primary jumpers)

Caution: As most applications will use the transducer with only one single primary turn ($N_p = 1$), much of this datasheet is written in terms of primary current instead of current linkages. However, the ampere-turns (At) unit is used to emphasize that current linkages are intended and applicable.

Transducer simplified model

The static model of the transducer at temperature T_A is:

$$I_S = G \cdot \Theta_p + \varepsilon$$

In which $\varepsilon =$

$$I_{OE} + I_{OT}(T_A) + \varepsilon_G \cdot \Theta_p \cdot G + \varepsilon_L(\Theta_{Pmax}) \cdot \Theta_{Pmax} \cdot G + TCG \cdot (T_A - 25) \cdot \Theta_p \cdot G$$

- With:
- $\Theta_p = N_p \cdot I_p$: primary current linkage (At)
 - Θ_{Pmax} : max primary current linkage applied to the transducer
 - I_S : secondary current (A)
 - T_A : ambient operating temperature (°C)
 - I_{OE} : electrical offset current (A)
 - $I_{OT}(T_A)$: temperature variation of I_O at temperature T_A (°C)
 - G : sensitivity of the transducer (V/At)
 - TCG : temperature coefficient of G
 - ε_G : sensitivity error
 - $\varepsilon_L(\Theta_{Pmax})$: linearity error for Θ_{Pmax}

This model is valid for primary ampere-turns Θ_p between $-\Theta_{Pmax}$ and $+\Theta_{Pmax}$ only.

Sensitivity and linearity

To measure sensitivity and linearity, the primary current (DC) is cycled from 0 to I_p , then to $-I_p$ and back to 0 (equally spaced $I_p/10$ steps). The sensitivity G is defined as the slope of the linear regression line for a cycle between $\pm I_{PN}$.

The linearity error ε_L is the maximum positive or negative difference between the measured points and the linear regression line, expressed in % of I_{PN} .

Magnetic offset

The magnetic offset current I_{OM} is the consequence of a current on the primary side ("memory effect" of the transducer's ferromagnetic parts). It is measured using the following primary current cycle. I_{OM} depends on the current value I_{P1} ($I_{P1} > I_{PM}$).

$$I_{OM} = \frac{V_{out}(t_1) - V_{out}(t_2)}{2} \cdot \frac{1}{G_{ff}}$$

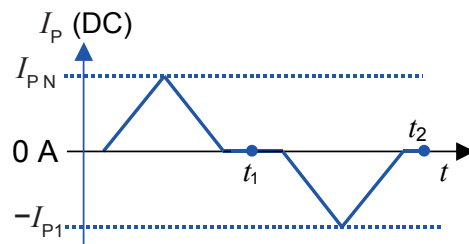

Figure 20: Current cycle used to measure magnetic and electrical offset (transducer supplied)

Performance parameters definition

Electrical offset

The electrical offset voltage V_{OE} can either be measured when the ferro-magnetic parts of the transducer are:

- completely demagnetized, which is difficult to realize,
- or in a known magnetization state, like in the current cycle shown in figure 20.

Using the current cycle shown in figure 20, the electrical offset is:

$$V_{OE} = \frac{V_{out}(t_1) + V_{out}(t_2)}{2}$$

The temperature variation V_{OT} of the electrical offset voltage V_{OE} is the variation of the electrical offset from 25 °C to the considered temperature:

$$V_{OT}(T) = V_{OE}(T) - V_{OE}(25^\circ\text{C})$$

Note: the transducer has to be demagnetized prior to the application of the current cycle (for example with a demagnetization tunnel).

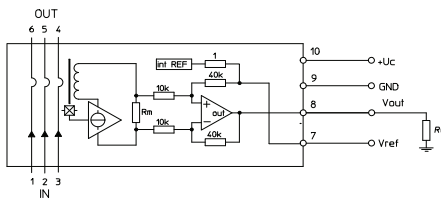

Figure 21: Test connection

Overall accuracy

The overall accuracy at 25 °C X_G is the error in the $-I_{PN} \dots +I_{PN}$ range, relative to the rated value I_{PN} .

It includes:

- the electrical offset V_{OE}
- the sensitivity error ϵ_G

the linearity error ϵ_L (to I_{PN})

Response and reaction times

The response time t_r and the reaction time t_{ra} are shown in figure 22

Both depend on the primary current di/dt . They are measured at nominal ampere-turns.

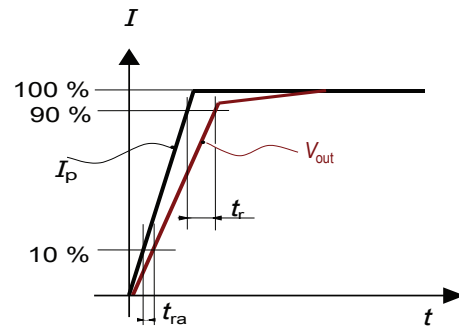

Figure 22: Response time t_r and reaction time t_{ra}

Application information

Filtering and decoupling

Supply voltage U_C

The transducer has internal decoupling capacitors, but in the case of a power supply with high impedance, it is highly recommended to provide local decoupling (100 nF or more, located close to the transducer) as it may reduce disturbance on transducer output V_{out} and reference V_{ref} due to high varying primary current. The transducer power supply rejection ratio is low at high frequency.

Output V_{out}

The output V_{out} has a very low output impedance of typically 1 Ohm; it can drive capacitive loads of up to 100 nF directly. Adding series resistance R_f of several tenths of Ohms allows much larger capacitive loads C_f (higher than 1 μ F). Empirical evaluation may be necessary to obtain optimum results. The minimum load resistance on V_{out} is 1 kOhm.

Total Primary Resistance

The primary resistance is 0.72 m Ω per conductor.

In the following table, examples of primary resistance according to the number of primary turns.

| Number of primary turns | Primary Nominal RMS current | Output voltage V_{out} | Primary resistance R_p [m Ω] | Recommended connections |
|-------------------------|-----------------------------|--------------------------|----------------------------------------|-------------------------|
| 1 | $\pm I_{PN}$ | $V_{ref} \pm 0.625$ | 0.24 | |
| 2 | $\pm I_{PN}/2$ | $V_{ref} \pm 0.625$ | 1.08 | |
| 3 | $\pm I_{PN}/3$ | $V_{ref} \pm 0.625$ | 2.16 | |

Reference V_{ref}

Like the output V_{out} , the V_{ref} has a very low output impedance of typically 1 Ohm; it can drive capacitive loads of up to 100 nF directly. Adding series resistance R_f of several tenths of Ohms allows much larger capacitive loads C_f (higher than 1 μ F). Empirical evaluation may be necessary to obtain optimum results. The minimum load resistance on V_{ref} is 10 kOhms.

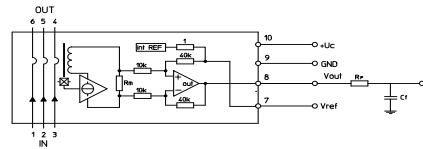

Figure 23: filtered V_{out} connection

External reference voltage

The REF pin can be used either as a reference voltage output or as a reference voltage input. When used in reference voltage output, the internal reference voltage V_{ref} is used by the transducer as the reference point for bipolar measurements.

The internal reference voltage output accuracy is defined in the electrical parameter data.

When used in reference voltage input, an external reference voltage is connected to the REF pin.

In this case, the maximum allowable reference voltage range is 0.5 V - 2.75 V.

The REF pin must be able to source or sink an input current of 1.5 mA maximum.

If the reference voltage is not used, the REF pin should be left unconnected.

The following graphs show how the measuring range of each transducer version depends on the external reference voltage value V_{ref} .

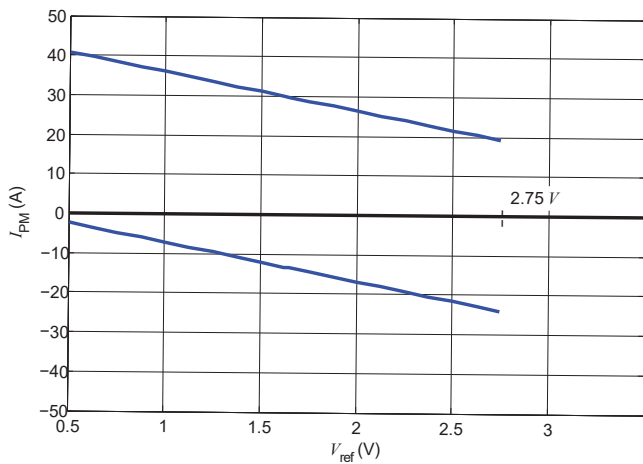

Figure 24: Measuring range versus external V_{ref}

Upper limit: $I_p = -9.6 * V_{ref} + 45.6$ ($V_{ref} = 0.5 \dots 2.75$ V)

Lower limit: $I_p = -9.6 * V_{ref} + 2.4$ ($V_{ref} = 0.5 \dots 2.75$ V)

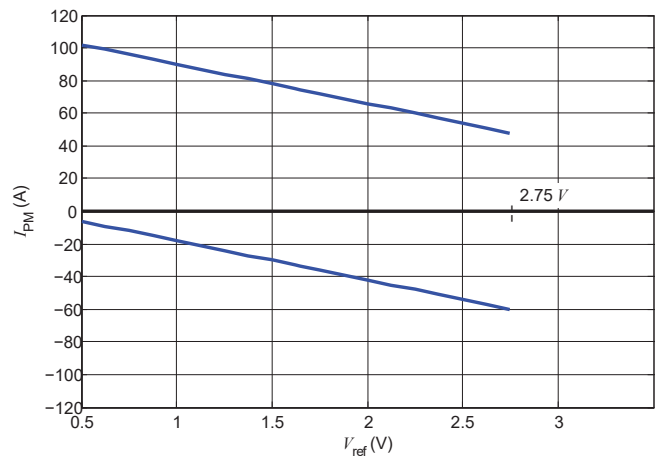

Figure 25: Measuring range versus external V_{ref}

Upper limit: $I_p = -24 * V_{ref} + 114$ ($V_{ref} = 0.5 \dots 2.75$ V)

Lower limit: $I_p = -24 * V_{ref} + 6$ ($V_{ref} = 0 \dots 2.75$ V)

External reference voltage

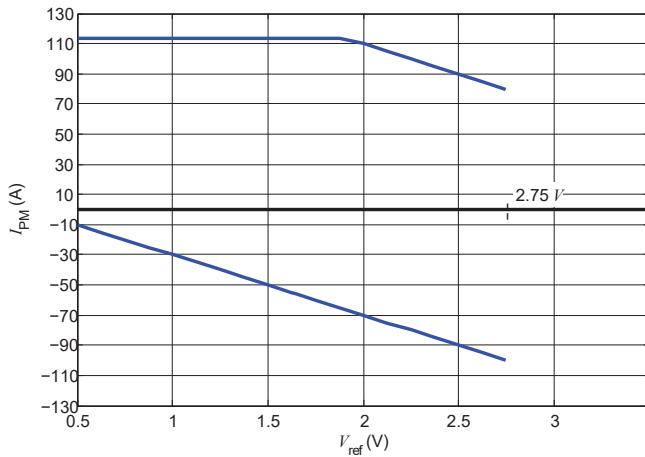

Figure 26: Measuring range versus external V_{ref} LXSR 25-NP

Upper limit: $I_p = -40 * V_{ref} + 190$ ($V_{ref} = 1.85 \dots 2.75$ V)

Upper limit: $I_p = 113$ ($V_{ref} = 0 \dots 1.85$ V)

Lower limit: $I_p = -40 * V_{ref} + 10$ ($V_{ref} = 0 \dots 2.75$ V)

Example with $V_{ref} = 1.65$ V:

- The 6 A version has a measuring range from -13.44 A to +29.76 A
- The 15 A version has a measuring range from -33.6 A to +74.4 A
- The 25 A version has a measuring range from -56 A to +113 A

Example with $V_{ref} = 0.5$ V:

- The 6 A version has a measuring range from -2.4 A to +40.8 A
- The 15 A version has a measuring range from -6 A to +102 A
- The 25 A version has a measuring range from -10 A to +113 A

Dimensions (in mm)

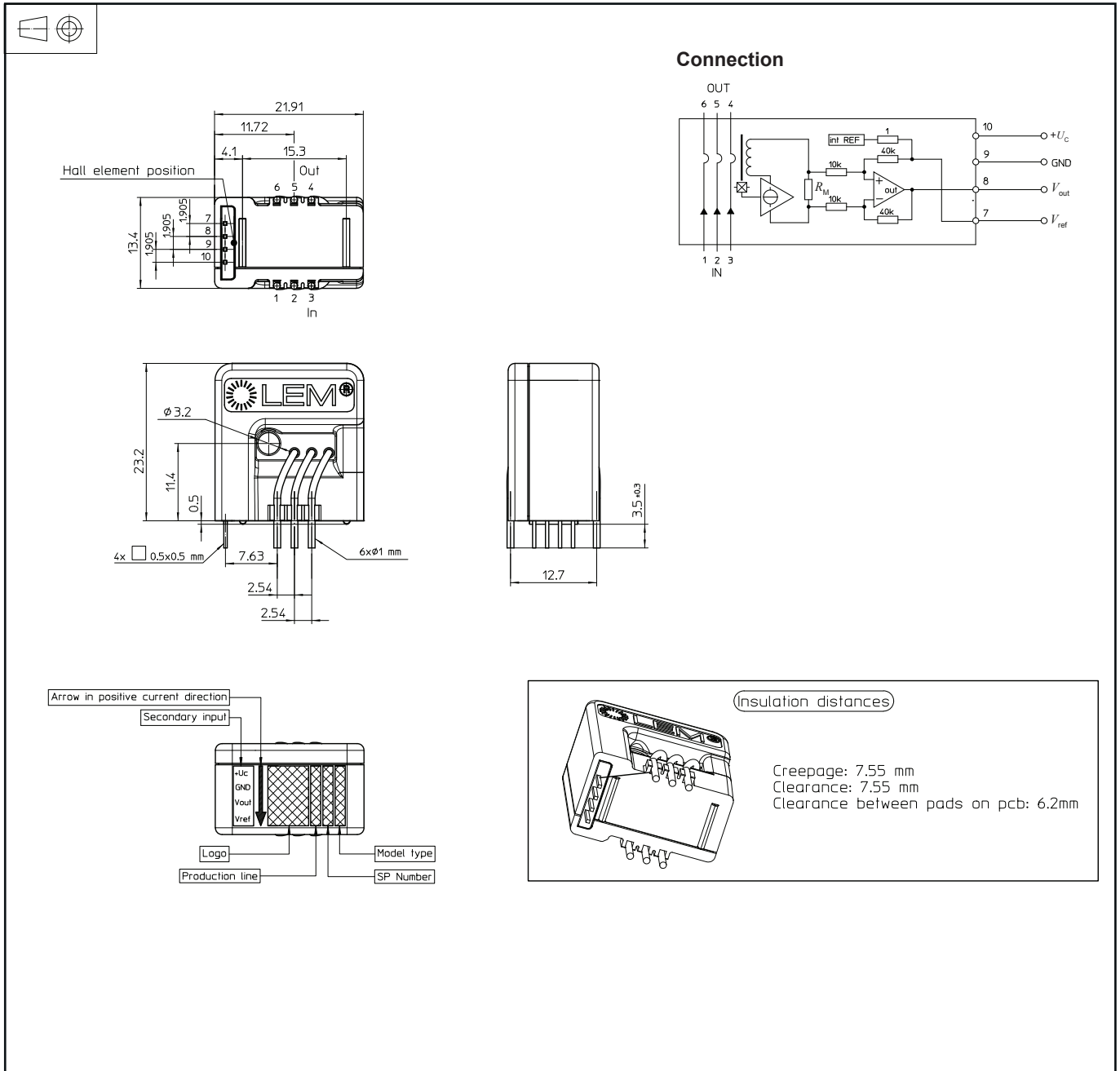

Packaging information

Standard delivery in cardboard: L × W × H: 315 × 200 × 120 mm

Each cardboard contains 200 parts, placed into 4 Polystyrene-made trays of 50 parts each one.

Both trays and cardboard are ESD-compliant.

The typical weight of the cardboard is 2.5 Kg.

