



Chipsmall Limited consists of a professional team with an average of over 10 year of expertise in the distribution of electronic components. Based in Hongkong, we have already established firm and mutual-benefit business relationships with customers from,Europe,America and south Asia,supplying obsolete and hard-to-find components to meet their specific needs.

With the principle of “Quality Parts,Customers Priority,Honest Operation,and Considerate Service”,our business mainly focus on the distribution of electronic components. Line cards we deal with include Microchip,ALPS,ROHM,Xilinx,Pulse,ON,Everlight and Freescale. Main products comprise IC,Modules,Potentiometer,IC Socket,Relay,Connector.Our parts cover such applications as commercial,industrial, and automotives areas.

We are looking forward to setting up business relationship with you and hope to provide you with the best service and solution. Let us make a better world for our industry!



## Contact us

Tel: +86-755-8981 8866 Fax: +86-755-8427 6832

Email & Skype: info@chipsmall.com Web: www.chipsmall.com

Address: A1208, Overseas Decoration Building, #122 Zhenhua RD., Futian, Shenzhen, China



# Studio White LED Emitter

## LZP-00SW00

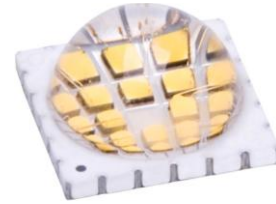

### Key Features

- 24-die Studio White (5300K) LED
- CCT and color rendering matched to HID arc lamp
- CRI85 minimum / R9 50 typical
- Up to 90 Watt power dissipation on compact 12.0mm x 12.0mm footprint
- Industry lowest thermal resistance per package size (0.6°C/W)
- Engineered ceramic package with integrated glass lens
- JEDEC Level 1 for Moisture Sensitivity Level
- Lead (Pb) free and RoHS compliant
- Reflow solderable (up to 6 cycles)
- Copper core MCPCB option with emitter thermal slug directly soldered to the copper core
- Full suite of TIR secondary optics family available

### Typical Applications

- Studio Lighting
- Photography Lighting
- High-end retail Lighting
- Showrooms Lighting

### Description

The LZP-00SW00 Studio White LED emitter features CCT and color rendering matched to HID arc lamps used in studio lighting. It delivers a daylight color temperature of 5300K, CRI greater than 85 and R9 red content of 50, resulting in a natural color rendering of skin tones and other colors, which cannot be obtained by standard daylight white LED emitters. The emitter, based on LED Engin's LuxiGen technology platform, may be driven up to 90W of power in a compact 12.0mmx12.0mm footprint. It has the industry lowest thermal resistance per package size, which allows users to drive the emitter with higher current, while keeping the junction temperature low to ensure long operating life.

## Part number options

### Base part number

Part number	Description
LZP-00SW00-xxxx	LZP Studio White emitter
LZP-D0SW00-xxxx	LZP Studio White emitter on 5 channel 4x6+1 Star MCPCB

### Bin kit option codes

SW, Studio-White (5300K)			
Kit number suffix	Min flux Bin	Chromaticity bins	Description
0000	G2	2D, 2C, 3A, 3B	full distribution flux; full distribution CCT

## Studio White Chromaticity Groups

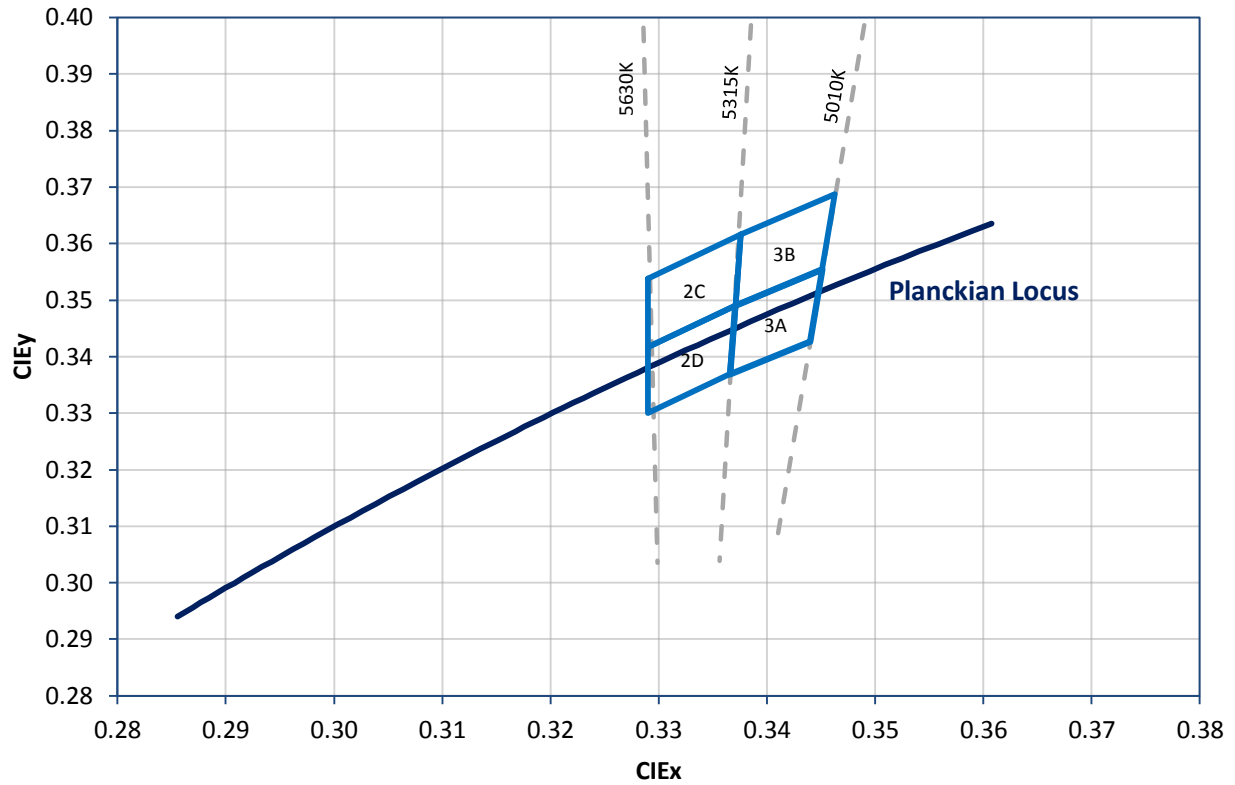

Standard Chromaticity Groups plotted on excerpt from the CIE 1931 (2°) x-y Chromaticity Diagram. Coordinates are listed below in the table.

## Studio White Bin Coordinates

Bin code	CIE <sub>x</sub>	CIE <sub>y</sub>	Bin code	CIE <sub>x</sub>	CIE <sub>y</sub>
2D	0.329	0.3417	2C	0.329	0.3538
	0.3371	0.349		0.3376	0.3616
	0.3366	0.3369		0.3371	0.349
	0.329	0.33		0.329	0.3417
3A	0.329	0.3417	0.329	0.3538	
	0.3371	0.349	0.3376	0.3616	
	0.3451	0.3554	0.3463	0.3687	
	0.344	0.3427	0.3451	0.3554	
	0.3366	0.3369	0.3371	0.349	
	0.3371	0.349	0.3376	0.3616	

## Luminous Flux Bins

Table 1:

Bin Code	Minimum Luminous Flux ( $\Phi_V$ ) @ $I_F = 700\text{mA}$ <sup>[1,2]</sup> (lm)	Maximum Luminous Flux ( $\Phi_V$ ) @ $I_F = 700\text{mA}$ <sup>[1,2]</sup> (lm)
G2	3,200	3,500
H2	3,500	3,800

Notes:

1. Luminous flux performance guaranteed within published operating conditions. LED Engin maintains a tolerance of  $\pm 10\%$  on flux measurements.
2. Luminous Flux typical value is for all 24 LED dies operating at rated current. The LED is configured with 4 Channels of 6 dies in series.

## Forward Voltage Bin

Table 2:

Bin Code	Minimum Forward Voltage ( $V_F$ ) @ $I_F = 700\text{mA}$ /Channel <sup>[1]</sup> (V)	Maximum Forward Voltage ( $V_F$ ) @ $I_F = 700\text{mA}$ /Channel <sup>[1]</sup> (V)
0	18.0 <sup>[2,3]</sup>	21.6 <sup>[2,3]</sup>

Notes:

1. LED Engin maintains a tolerance of  $\pm 0.24\text{V}$  for forward voltage measurements.
2. All 4 white Channels have matched  $V_F$  for parallel operation
3. Forward Voltage is binned with 6 LED dies connected in series. The LED is configured with 4 Channels of 6 dies in series each.

## Absolute Maximum Ratings

Table 3:

Parameter	Symbol	Value	Unit
DC Forward Current at $T_{jmax}=135^{\circ}\text{C}^{[1]}$	$I_F$	1200	mA
DC Forward Current at $T_{jmax}=150^{\circ}\text{C}^{[1]}$	$I_F$	1000	mA
Peak Pulsed Forward Current <sup>[2]</sup>	$I_{FP}$	1500 /Channel	mA
Reverse Voltage	$V_R$	See Note 3	V
Storage Temperature	$T_{stg}$	-40 ~ +150	$^{\circ}\text{C}$
Junction Temperature	$T_J$	150	$^{\circ}\text{C}$
Soldering Temperature <sup>[4]</sup>	$T_{sol}$	260	$^{\circ}\text{C}$
Allowable Reflow Cycles		6	
ESD Sensitivity <sup>[5]</sup>		> 8,000 V HBM Class 3B JESD22-A114-D	

Notes:

- Maximum DC forward current (per die) is determined by the overall thermal resistance and ambient temperature. Follow the curves in Figure 10 for current de-rating.
- Pulse forward current conditions: Pulse Width  $\leq 10\text{msec}$  and Duty cycle  $\leq 10\%$ .
- LEDs are not designed to be reverse biased.
- Solder conditions per JEDEC 020D. See Reflow Soldering Profile Figure 5.
- LED Engin recommends taking reasonable precautions towards possible ESD damages and handling the LZP-00SW00 in an electrostatic protected area (EPA). An EPA may be adequately protected by ESD controls as outlined in ANSI/ESD S6.1.

## Optical Characteristics @ $T_C = 25^{\circ}\text{C}$

Table 4:

Parameter	Symbol	Typical	Unit
Luminous Flux (@ $I_F = 700\text{mA}^{[1]}$ )	$\Phi_V$	3600	lm
Luminous Flux (@ $I_F = 1000\text{mA}^{[1]}$ )	$\Phi_V$	4650	lm
Luminous Efficacy (@ $I_F = 350\text{mA}$ )		85	lm/W
Correlated Color Temperature	CCT	5300	K
Color Rendering Index (CRI)	$R_a$	88	
Viewing Angle <sup>[2]</sup>	$2\Theta_{1/2}$	110	Degrees

Notes:

- Luminous flux typical value is for all 24 LED dies operating at rated current.
- Viewing Angle is the off-axis angle from emitter centerline where the luminous intensity is  $\frac{1}{2}$  of the peak value.

## Electrical Characteristics @ $T_C = 25^{\circ}\text{C}$

Table 5:

Parameter	Symbol	Typical	Unit
Forward Voltage (@ $I_F = 700\text{mA}^{[1]}$ )	$V_F$	19.4 /Channel	V
Forward Voltage (@ $I_F = 1000\text{mA}^{[1]}$ )	$V_F$	20.0 /Channel	V
Temperature Coefficient of Forward Voltage <sup>[1]</sup>	$\Delta V_F/\Delta T_J$	-12.0	mV/ $^{\circ}\text{C}$
Thermal Resistance (Junction to Case)	$R\Theta_{J-C}$	0.6	$^{\circ}\text{C}/\text{W}$

Notes:

- Forward Voltage is measured for a single string of 6 dies connected in series. The LED is configured with 4 Channels of 6 dies in series each.

## IPC/JEDEC Moisture Sensitivity Level

Table 6 - IPC/JEDEC J-STD-20D.1 MSL Classification:

Level	Soak Requirements					
	Floor Life		Standard		Accelerated	
	Time	Conditions	Time (hrs)	Conditions	Time (hrs)	Conditions
1	unlimited	≤ 30°C/ 85% RH	168 +5/-0	85°C/ 85% RH	n/a	n/a

Notes:

- The standard soak time includes a default value of 24 hours for semiconductor manufacturer's exposure time (MET) between bake and bag and includes the maximum time allowed out of the bag at the distributor's facility.

## Average Lumen Maintenance Projections

Lumen maintenance generally describes the ability of a lamp to retain its output over time. The useful lifetime for solid state lighting devices (Power LEDs) is also defined as Lumen Maintenance, with the percentage of the original light output remaining at a defined time period. L70 defines the amount of operating hours at which the light output has reached 70% of its original output.

### 25 die (700mA & 1000mA, Rjc=0.6) L70 de-rating

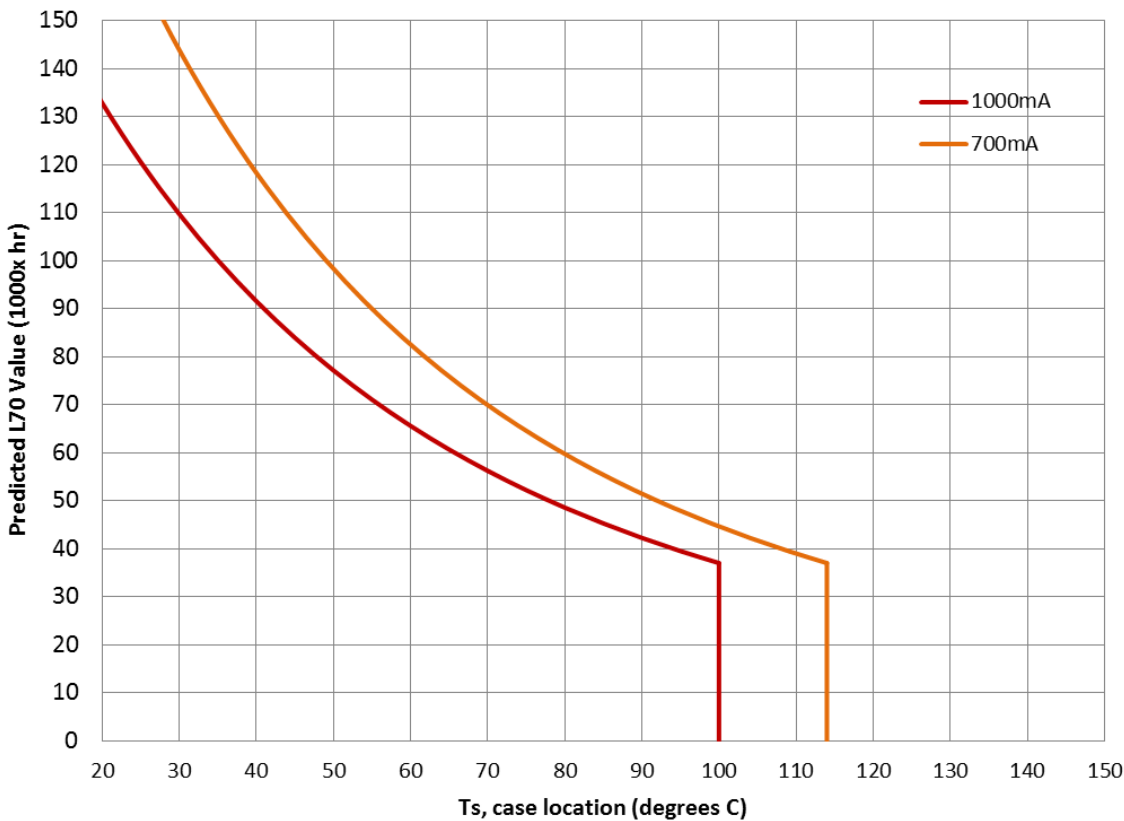

Figure 1: De-rating curve for operation of all dies at 700mA

Notes:

- See Figure 2 in Mechanical Dimensions section for exact Ts location.

## Mechanical Dimensions (mm)

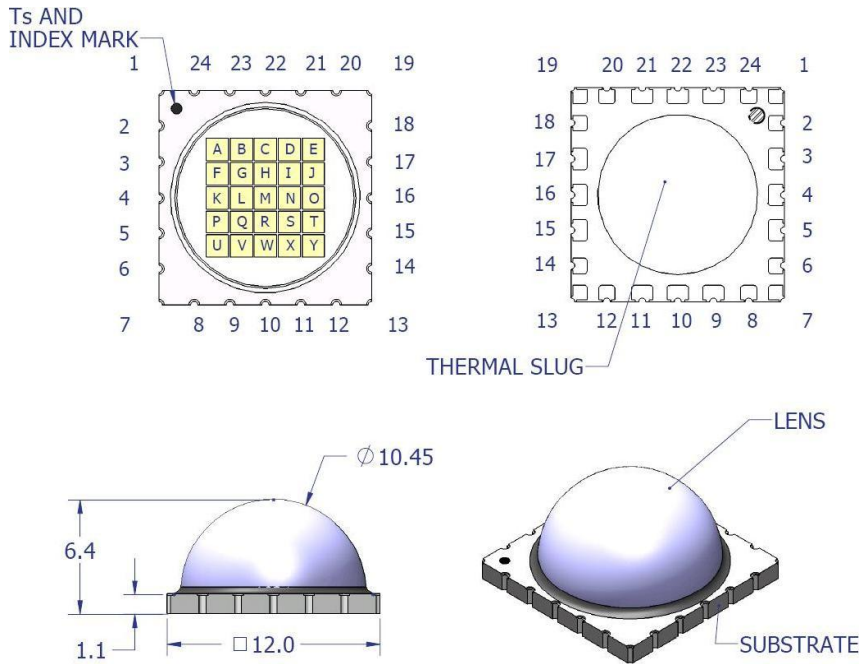

Figure 2: Package outline drawing.

### Notes:

1. LZP-00SW00 pin out polarity is reversed; therefore it is not compatible with MCPCB designed for other LZP White emitters (i.e LZP-00xW00).
2. Index mark, Ts indicates case temperature measurement point.
3. Unless otherwise noted, the tolerance =  $\pm 0.20$  mm.
4. Thermal slug is electrically isolated

Pin Out				
Ch.	Pad	Die	Color	Function
1	18	E	SW	Cathode
		D	SW	na
		C	SW	na
		B	SW	na
		A	SW	na
		24	F	SW
2	17	J	SW	Cathode
		I	SW	na
		H	SW	na
		G	SW	na
		L	SW	na
		3	K	SW
3	15	O	SW	Cathode
		N	SW	na
		S	SW	na
		R	SW	na
		Q	SW	na
		5	P	SW
4	14	T	SW	Cathode
		Y	SW	na
		X	SW	na
		W	SW	na
		V	SW	na
		8	U	SW
5	2	M	-	na
	23	M	-	na

## Recommended Solder Pad Layout (mm)

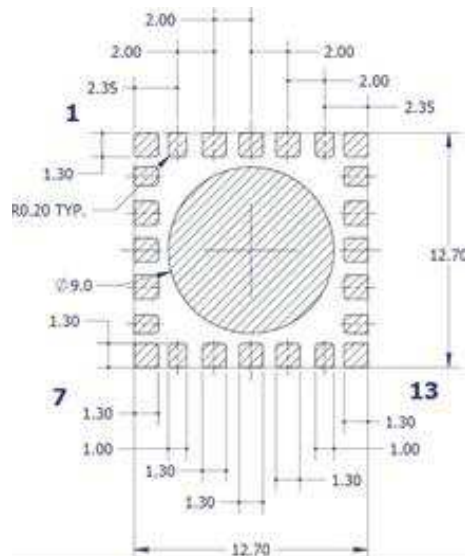
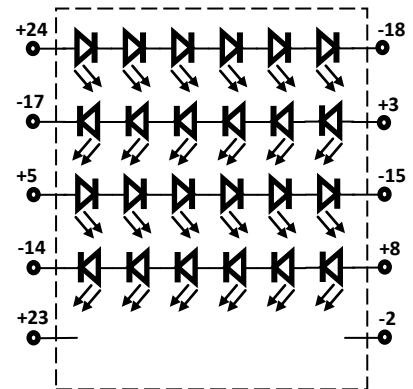

Figure 3: Recommended solder mask opening (hatched area) for anode, cathode, and thermal pad.

### Notes:

1. Unless otherwise noted, the tolerance =  $\pm 0.20$  mm.
2. LED Engin recommends the use of copper core MCPCB's which allow for the emitter thermal slug to be soldered directly to the copper core (so called pedestal design). Such MCPCB technologies eliminate the high thermal resistance dielectric layer that standard MCPCB technologies use in between the emitter thermal slug and the metal core of the MCPCB, thus lowering the overall system thermal resistance.
3. LED Engin recommends x-ray sample monitoring to screen for solder voids underneath the emitter thermal slug. The total area covered by solder voids should be less than 20% of the total emitter thermal slug area. Excessive solder voids will increase the emitter to MCPCB thermal resistance and may lead to higher failure rates due to thermal over stress.





## Reflow Soldering Profile

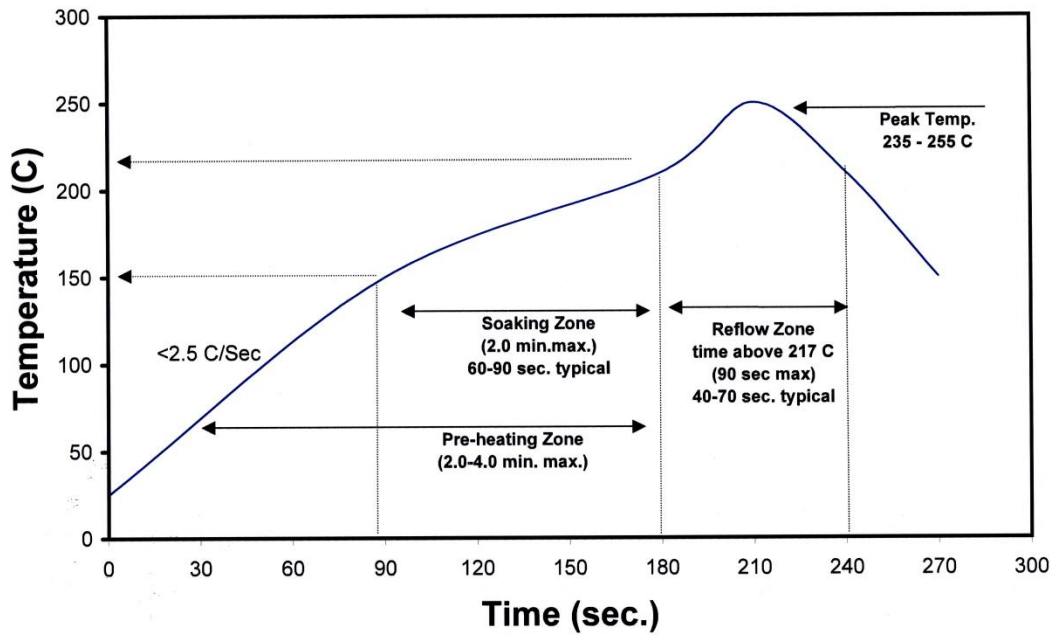

Figure 4: Reflow soldering profile for lead free soldering.

## Typical Radiation Pattern

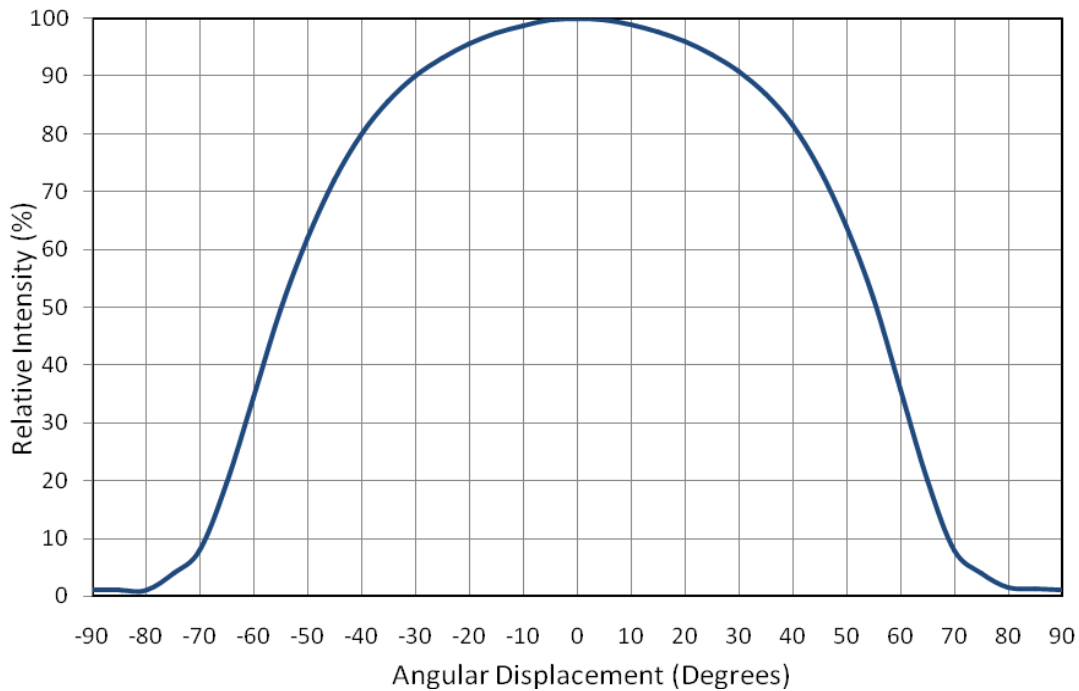

Figure 5: Typical representative spatial radiation pattern.

### Typical Relative Spectral Power Distribution

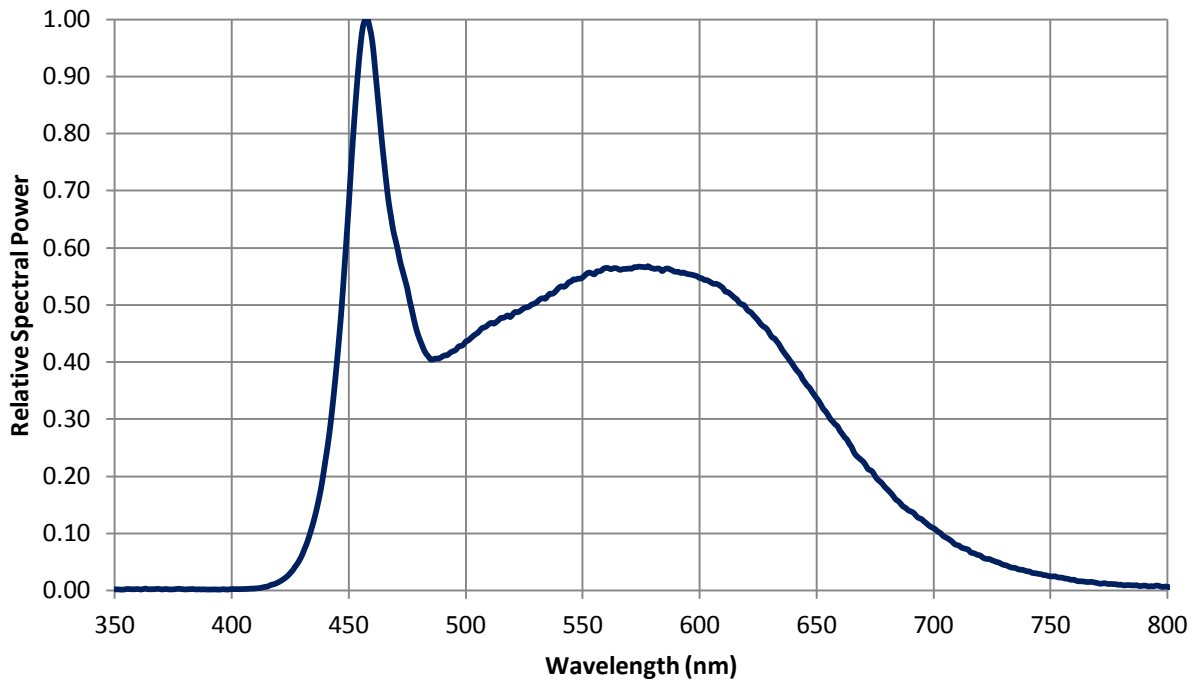

Figure 6: Typical relative spectral power vs. wavelength @ T<sub>c</sub> = 25°C.

### Typical Chromaticity Coordinate Shift over Temperature

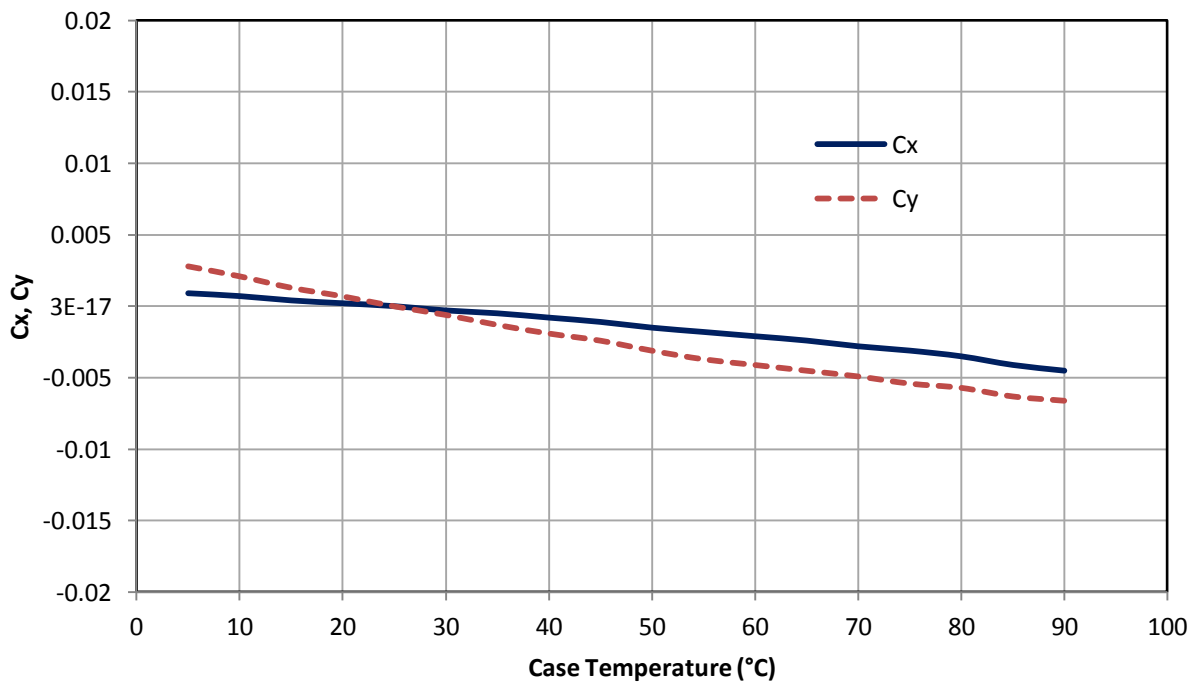

Figure 7: Typical chromaticity coordinate shift vs. Case temperature.

### Typical Relative Light Output

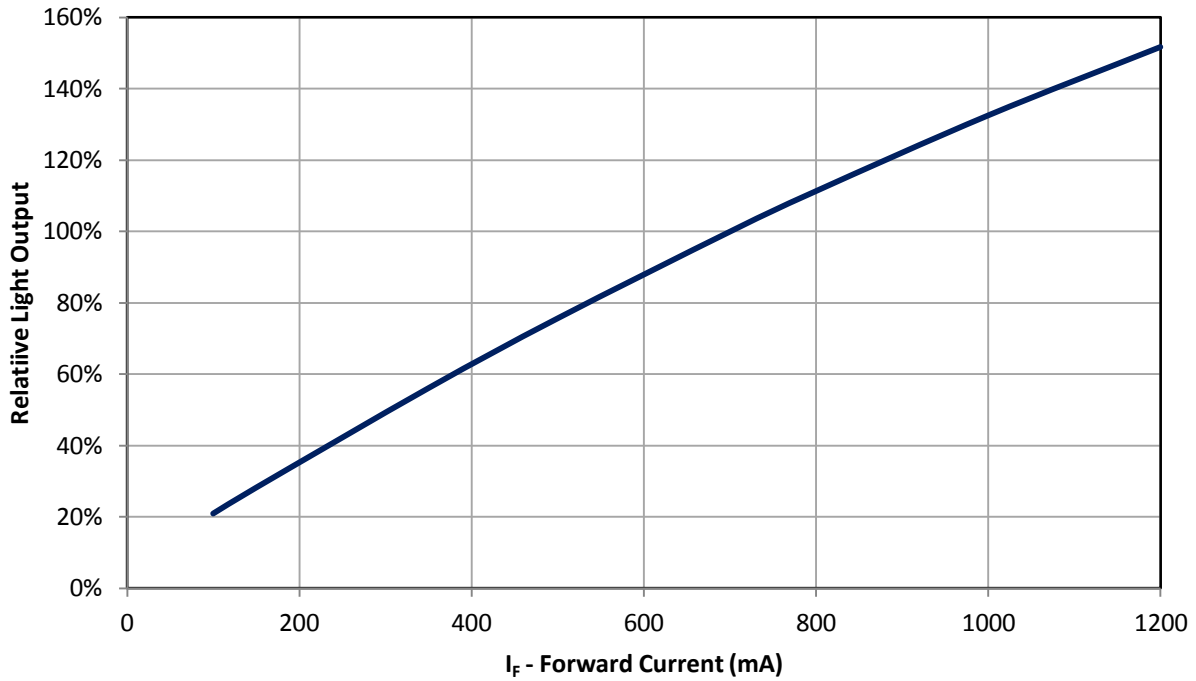

Figure 8: Typical relative light output vs. forward current @  $T_c = 25^\circ\text{C}$ .

Notes:

1. Luminous Flux typical value is for all 24 LED dies operating concurrently at rated current pro Channel.

### Typical Relative Light Output over Temperature

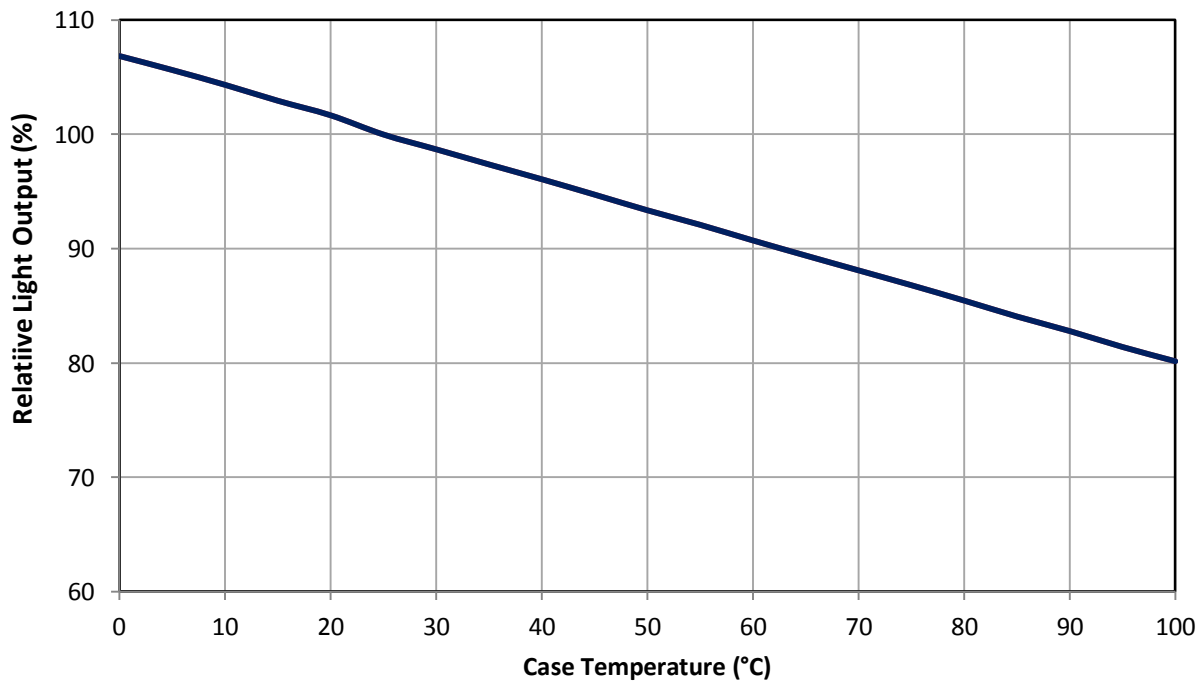

Figure 9: Typical relative light output vs. case temperature.

Notes:

1. Luminous Flux typical value is for all 24 LED dies operating concurrently at rated current pro Channel.

## Typical Forward Current Characteristics

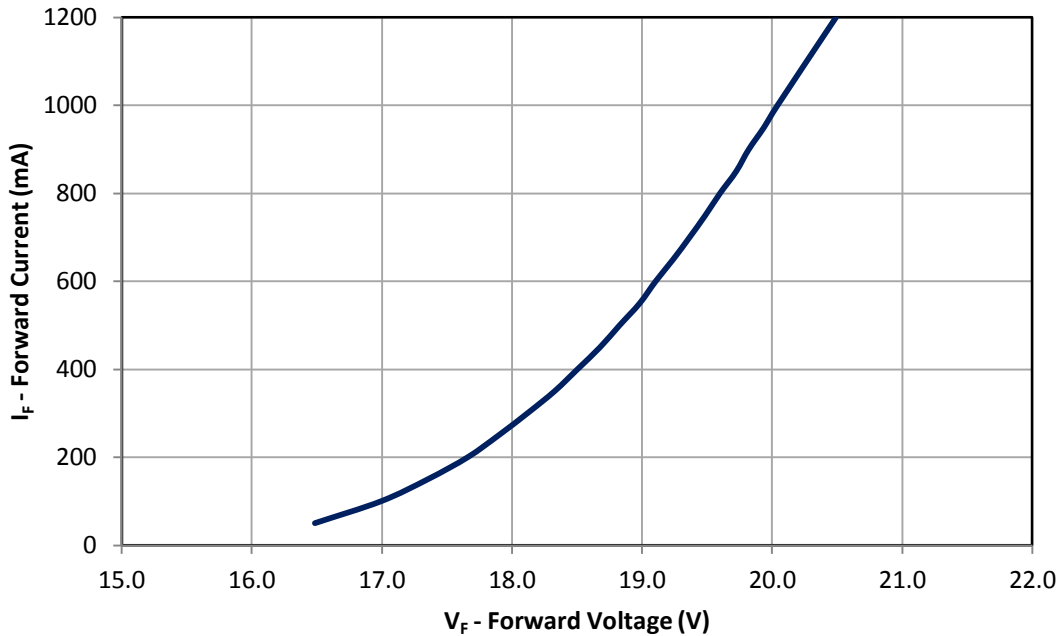

Figure 10: Typical forward current vs. forward voltage @  $T_c =$  at 25°C.

Note:

1. Forward Voltage is measured for a single string of 6 dies connected in series. The LED is configured with 4 Channels of 6 dies in series each.

## Current De-rating

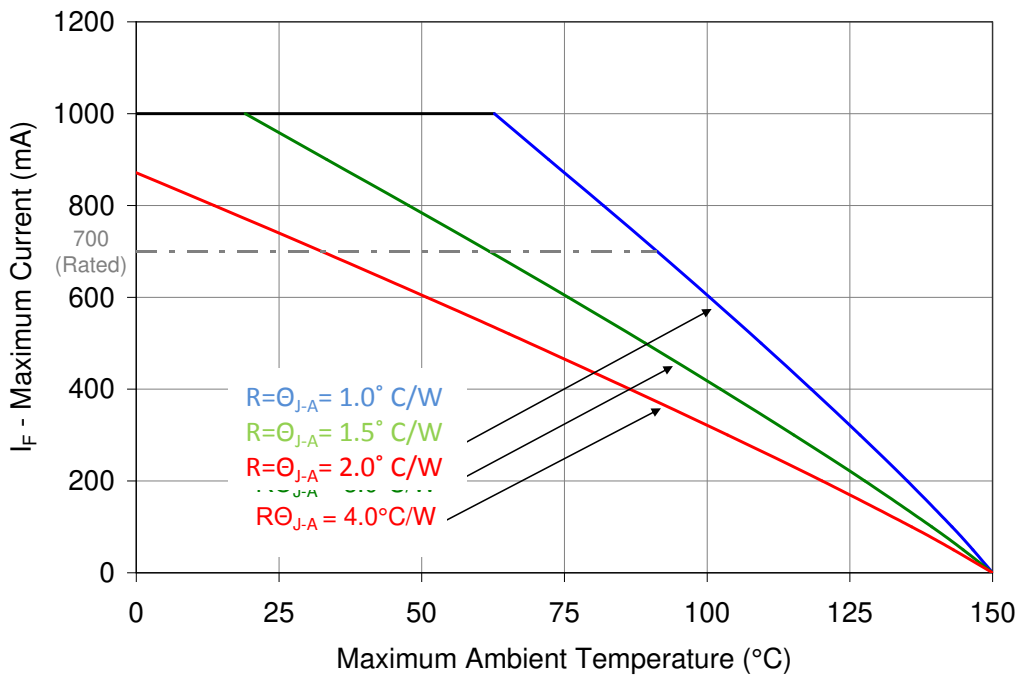

Figure 11: Maximum forward current vs. ambient temperature based on  $T_{J(\text{MAX})} = 150^\circ\text{C}$ .

Notes:

1. Maximum current assumes that all LED dies are operating at rated current.
2.  $RO_{J-C}$  [Junction to Case Thermal Resistance] for the LZP-series is typically  $0.6^\circ\text{C/W}$ .
3.  $RO_{J-A}$  [Junction to Ambient Thermal Resistance] =  $RO_{J-C} + RO_{C-A}$  [Case to Ambient Thermal Resistance].

## Emitter Tape and Reel Specifications (mm)



Figure 12: Emitter carrier tape specifications (mm).



Figure 13: Emitter Reel specifications (mm).

# LZP MCPCB Family

Part number	Type of MCPCB	Diameter (mm)	Emitter + MCPCB Thermal Resistance (°C/W)	Typical V <sub>f</sub> (V)	Typical I <sub>f</sub> (mA)
LZP-D0SW00	5-channel (4x6+1 strings)	28.3	0.6 + 0.1 = 0.7	19.4	4 x 700

## Mechanical Mounting of MCPCB

- MCPCB bending should be avoided as it will cause mechanical stress on the emitter, which could lead to substrate cracking and subsequently LED dies cracking.
- To avoid MCPCB bending:
  - Special attention needs to be paid to the flatness of the heat sink surface and the torque on the screws.
  - Care must be taken when securing the board to the heat sink. This can be done by tightening three M3 screws (or #4-40) in steps and not all the way through at once. Using fewer than three screws will increase the likelihood of board bending.
  - It is recommended to always use plastics washers in combinations with the three screws.
  - If non-taped holes are used with self-tapping screws, it is advised to back out the screws slightly after tightening (with controlled torque) and then re-tighten the screws again.

## Thermal interface material

- To properly transfer heat from LED emitter to heat sink, a thermally conductive material is required when mounting the MCPCB on to the heat sink.
- There are several varieties of such material: thermal paste, thermal pads, phase change materials and thermal epoxies. An example of such material is Electrolube EHTC.
- It is critical to verify the material's thermal resistance to be sufficient for the selected emitter and its operating conditions.

## Wire soldering

- To ease soldering wire to MCPCB process, it is advised to preheat the MCPCB on a hot plate of 125-150°C. Subsequently, apply the solder and additional heat from the solder iron will initiate a good solder reflow. It is recommended to use a solder iron of more than 60W.
- It is advised to use lead-free, no-clean solder. For example: SN-96.5 AG-3.0 CU 0.5 #58/275 from Kester (pn: 24-7068-7601)

# LZP-D0SW00

## 5-channel, Standard Star MCPCB (4x6+1) Mechanical Dimensions (mm)

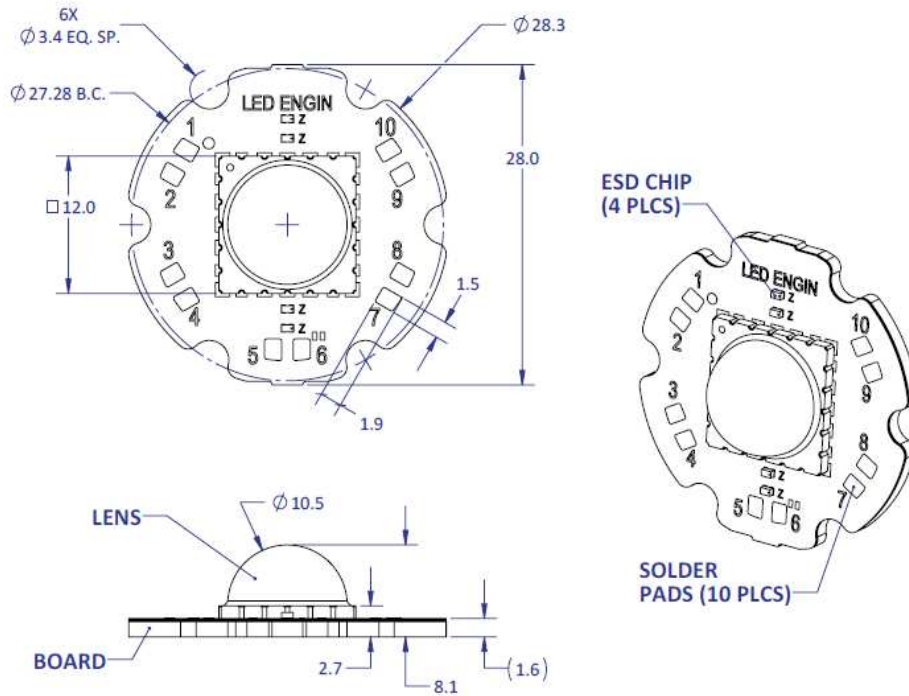

**Notes:**

- Unless otherwise noted, the tolerance =  $\pm 0.20$  mm.
- Slots in MCPCB are for M3 or #4 mounting screws.
- LED Engin recommends using plastic washers to electrically insulate screws from solder pads and electrical traces.
- LED Engin recommends using thermal interface material when attaching the MCPCB to a heat sink.
- LED Engin uses a copper core MCPCB with pedestal design, allowing direct solder connect between the MCPCB copper core and the emitter thermal slug. The thermal resistance of this copper core MCPCB is:  $R_{\theta C-B} 0.1^{\circ}\text{C/W}$

## Components used

MCPCB: SuperMCPCB (Bridge Semiconductor, copper core with pedestal design)  
 ESD chips: BZT52C36LP (NXP, for 6 LED dies in series)

Pad layout			
Ch.	MCPCB Pad	String/die	Function
1	1	1/EDCBAF	Anode +
	10		Cathode -
2	2	2/JIHGLK	Anode +
	9		Cathode -
3	3	3/ONS RQP	Anode +
	8		Cathode -
4	4	4/TYXWVU	Anode +
	7		Cathode -
5	5	5/M	N/A
	6		N/A

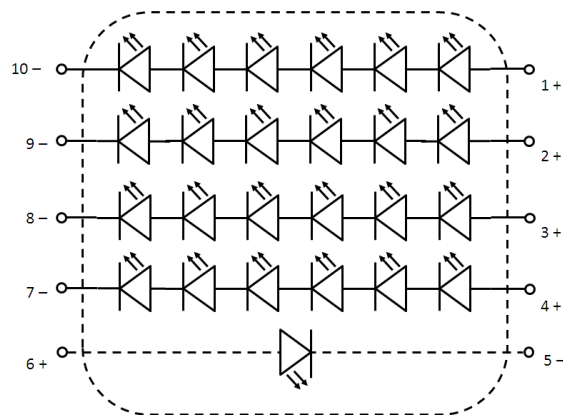

## Appendix: Wire Insertion and Extraction Instructions AVX poke-home

For the AVX poke-home it is recommended to use solid wires with gauge size, 18, 20 or 22 AWG, but stranded wire can be used as well. Push the wire in and then give slight tug on the wire to confirm that it is properly engaged.

### Wire Insertion Solid conductor

- Strip insulation length 4-5mm
- Insert into appropriate hole to a stop
- Inserted wire will be retained by contact

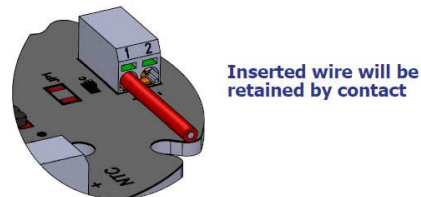
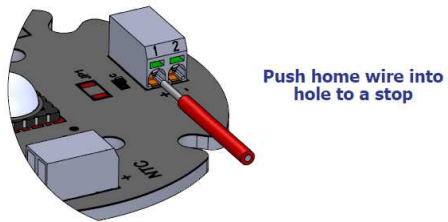

### Wire Insertion Stranded wire conductor

- Twist strands together
- Insert tool into contact operation slot
- Insert wire
- Remove tool

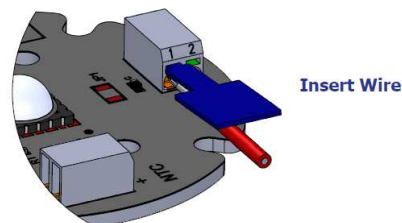
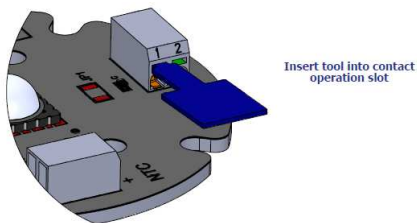
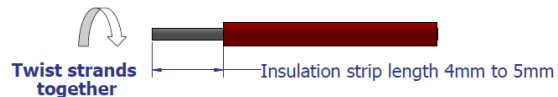

### Wire extraction

- Insert tool into contact
- Extract wire
- Remove tool

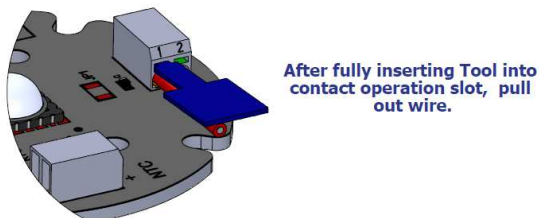

### Extraction Tool References:

Thin Blade Wire Extraction Tool: AVX P/N - 0692-7670-0101-000 or  
Miniature Precision Screw Driver, 0.047" Tip Width



## Company Information

LED Engin, based in California's Silicon Valley, develops, manufactures, and sells advanced LED emitters, optics and light engines to create uncompromised lighting experiences for a wide range of entertainment, architectural, general lighting and specialty applications. LuxiGen™ multi-die emitter and secondary lens combinations reliably deliver industry-leading flux density, upwards of 5000 quality lumens to a target, in a wide spectrum of colors including whites, tunable whites, multi-color and UV LEDs in a unique patented compact ceramic package. Our LuxiTune™ series of tunable white lighting modules leverage our LuxiGen emitters and lenses to deliver quality, control, freedom and high density tunable white light solutions for a broad range of new recessed and downlighting applications. The small size, yet remarkably powerful beam output and superior in-source color mixing, allows for a previously unobtainable freedom of design wherever high-flux density, directional light is required.

LED Engin is committed to providing products that conserve natural resources and reduce greenhouse emissions.

LED Engin reserves the right to make changes to improve performance without notice.

Please contact [sales@ledengin.com](mailto:sales@ledengin.com) or (408) 922-7200 for more information.