



Chipsmall Limited consists of a professional team with an average of over 10 year of expertise in the distribution of electronic components. Based in Hongkong, we have already established firm and mutual-benefit business relationships with customers from,Europe,America and south Asia,supplying obsolete and hard-to-find components to meet their specific needs.

With the principle of “Quality Parts,Customers Priority,Honest Operation,and Considerate Service”,our business mainly focus on the distribution of electronic components. Line cards we deal with include Microchip,ALPS,ROHM,Xilinx,Pulse,ON,Everlight and Freescale. Main products comprise IC,Modules,Potentiometer,IC Socket,Relay,Connector.Our parts cover such applications as commercial,industrial, and automotives areas.

We are looking forward to setting up business relationship with you and hope to provide you with the best service and solution. Let us make a better world for our industry!



## Contact us

Tel: +86-755-8981 8866 Fax: +86-755-8427 6832

Email & Skype: info@chipsmall.com Web: www.chipsmall.com

Address: A1208, Overseas Decoration Building, #122 Zhenhua RD., Futian, Shenzhen, China



## LZP-Series

Highest Lumen Density

Cool White Emitter

# LZP-00CW0R

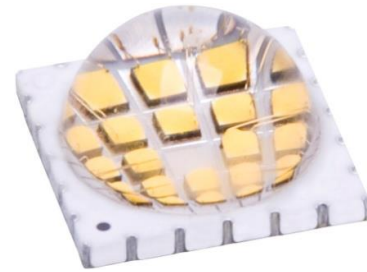

### Key Features

- Highest luminous flux / area single LED emitter
  - 5700lm Cool White
  - 40mm<sup>2</sup> light emitting area
- Up to 90 Watt power dissipation on compact 12.0mm x 12.0mm footprint
- Industry lowest thermal resistance per package size (0.6°C/W)
- Industry leading lumen maintenance
- Color Point Stability 7x improvement over Energy Star requirements
- Surface mount ceramic package with integrated glass lens
- JEDEC Level 1 for Moisture Sensitivity Level
- Lead (Pb) free and RoHS compliant
- Reflow solderable (up to 6 cycles)
- Copper core MCPCB option with emitter thermal slug directly soldered to the copper core
- Full suite of TIR secondary optics family available

### Typical Applications

- High Bay and Low Bay
- General lighting
- Stage and Studio lighting
- Architectural lighting
- Street lighting

### Description

The LZP-00CW0R Cool White LED emitter can dissipate up to 90W of power in an extremely small package. With a small 12.0mm x 12.0mm footprint, this package provides unmatched luminous flux density. The high quality materials used in the package are chosen to optimize light output and minimize stresses which results in superior reliability and lumen maintenance. The robust product design thrives in outdoor applications with high ambient temperatures and high humidity.

## Part number options

### Base part number

Part number	Description
LZP-00CW0R-xxxx	LZP Cool White emitter
LZP-D0CW0R-xxxx	LZP Cool White emitter on 5 channel 4x6+1 Star MCPCB

### Bin kit option codes

CW, Cool White (5000K – 6500K)			
Kit number suffix	Min flux Bin	Chromaticity bins	Description
0055	J2	2U, 2Y, 3U, 2A, 2D, 3A, 2B, 2C, 3B, 2V, 2X, 3V	full distribution flux; 5500K bin
0065	J2	1U, 1A, 1B, 1V, 1Y, 1D, 1C, 1X, 2U, 2A, 2B, 2V	full distribution flux; 6500K bin

### Cool White Chromaticity Groups

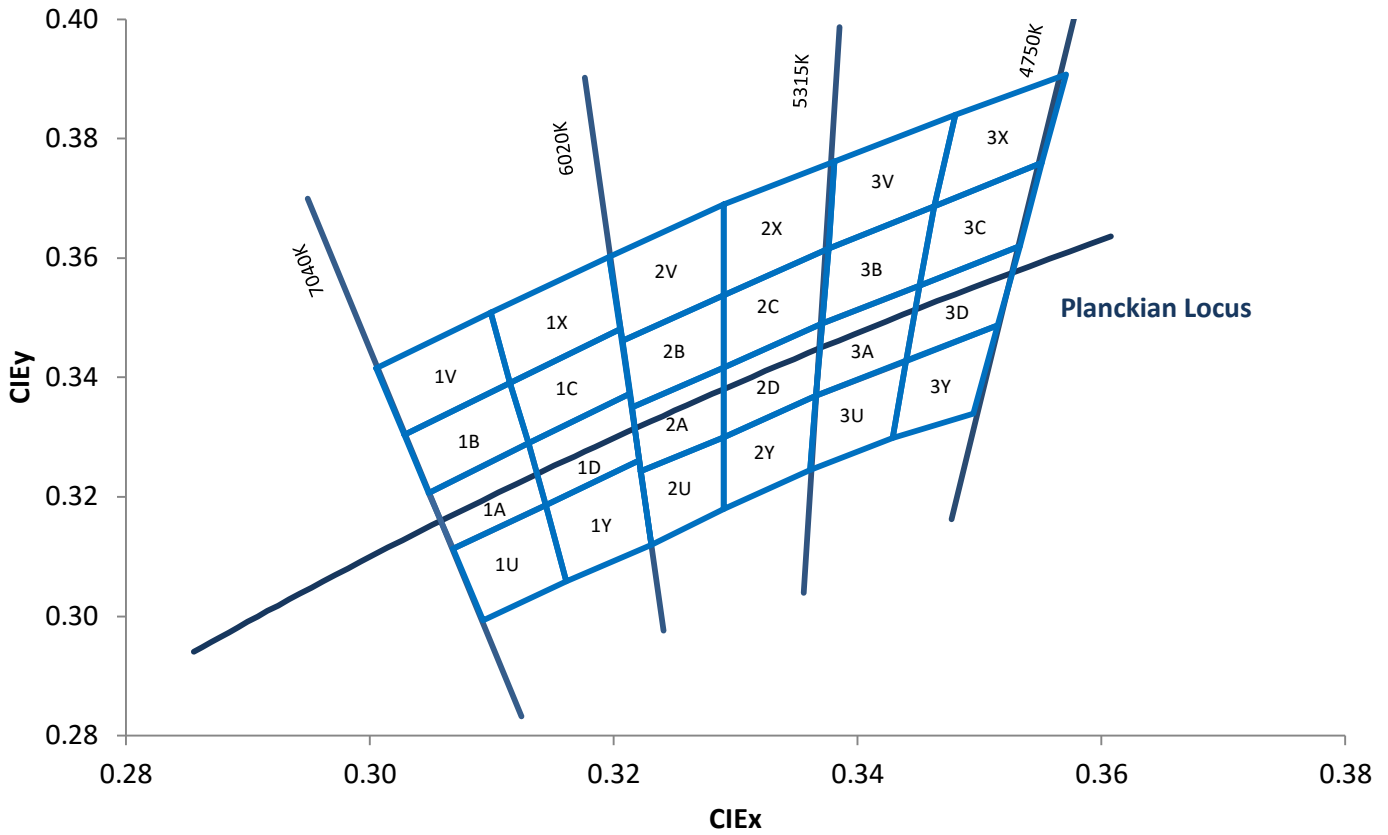

Standard Chromaticity Groups plotted on excerpt from the CIE 1931 (2°) x-y Chromaticity Diagram. Coordinates are listed below in the table.

## Cool White Bin Coordinates

Bin code	CIE <sub>x</sub>	CIE <sub>y</sub>	Bin code	CIE <sub>x</sub>	CIE <sub>y</sub>	Bin code	CIE <sub>x</sub>	CIE <sub>y</sub>	Bin code	CIE <sub>x</sub>	CIE <sub>y</sub>
1U	0.3068	0.3113	1A	0.3048	0.3207	1B	0.3028	0.3304	1V	0.3005	0.3415
	0.3144	0.3186		0.313	0.329		0.3115	0.3391		0.3099	0.3509
	0.3161	0.3059		0.3144	0.3186		0.313	0.329		0.3115	0.3391
	0.3093	0.2993		0.3068	0.3113		0.3048	0.3207		0.3028	0.3304
	0.3068	0.3113		0.3048	0.3207		0.3028	0.3304		0.3005	0.3415
1Y	0.3144	0.3186	1D	0.313	0.329	1C	0.3115	0.3391	1X	0.3099	0.3509
	0.3221	0.3261		0.3213	0.3373		0.3205	0.3481		0.3196	0.3602
	0.3231	0.312		0.3221	0.3261		0.3213	0.3373		0.3205	0.3481
	0.3161	0.3059		0.3144	0.3186		0.313	0.329		0.3115	0.3391
	0.3144	0.3186		0.313	0.329		0.3115	0.3391		0.3099	0.3509
2U	0.3222	0.3243	2A	0.3215	0.335	2B	0.3207	0.3462	2V	0.3196	0.3602
	0.329	0.33		0.329	0.3417		0.329	0.3538		0.329	0.369
	0.329	0.318		0.329	0.33		0.329	0.3417		0.329	0.3538
	0.3231	0.312		0.3222	0.3243		0.3215	0.335		0.3207	0.3462
	0.3222	0.3243		0.3215	0.335		0.3207	0.3462		0.3196	0.3602
2Y	0.329	0.33	2D	0.329	0.3417	2C	0.329	0.3538	2X	0.329	0.369
	0.3366	0.3369		0.3371	0.349		0.3376	0.3616		0.3381	0.3762
	0.3361	0.3245		0.3366	0.3369		0.3371	0.349		0.3376	0.3616
	0.329	0.318		0.329	0.33		0.329	0.3417		0.329	0.3538
	0.329	0.33		0.329	0.3417		0.329	0.3538		0.329	0.369
3U	0.3366	0.3369	3A	0.3371	0.349	3B	0.3376	0.3616	3V	0.3381	0.3762
	0.344	0.3428		0.3451	0.3554		0.3463	0.3687		0.348	0.384
	0.3429	0.3299		0.344	0.3427		0.3451	0.3554		0.3463	0.3687
	0.3361	0.3245		0.3366	0.3369		0.3371	0.349		0.3376	0.3616
	0.3366	0.3369		0.3371	0.349		0.3376	0.3616		0.3381	0.3762
3Y	0.344	0.3428	3D	0.3451	0.3554	3C	0.3463	0.3687	3X	0.348	0.384
	0.3515	0.3487		0.3533	0.362		0.3551	0.376		0.3571	0.3907
	0.3495	0.3339		0.3515	0.3487		0.3533	0.362		0.3551	0.376
	0.3429	0.3299		0.344	0.3427		0.3451	0.3554		0.3463	0.3687
	0.344	0.3428		0.3451	0.3554		0.3463	0.3687		0.348	0.384



## Luminous Flux Bins

Table 1:

<b>Bin Code</b>	<b>Minimum Luminous Flux (<math>\Phi_v</math>) @ <math>I_F = 700\text{mA}</math> /Channel<sup>[1,2]</sup> (lm)</b>	<b>Maximum Luminous Flux (<math>\Phi_v</math>) @ <math>I_F = 700\text{mA}</math> /Channel<sup>[1,2]</sup> (lm)</b>
J2	3,800	4,200
K2	4,200	4,600
L2	4,600	5,100

Notes:

1. Luminous flux performance guaranteed within published operating conditions. LED Engin maintains a tolerance of  $\pm 10\%$  on flux measurements.
2. Luminous Flux typical value is for all 24 LED dies operating at rated current. The LED is configured with 4 Channels of 6 dies in series.

## Forward Voltage Bin

Table 2:

<b>Bin Code</b>	<b>Minimum Forward Voltage (<math>V_F</math>) @ <math>I_F = 700\text{mA}</math> /Channel<sup>[1]</sup> (V)</b>	<b>Maximum Forward Voltage (<math>V_F</math>) @ <math>I_F = 700\text{mA}</math> /Channel<sup>[1]</sup> (V)</b>
0	18.0 <sup>[2,3]</sup>	21.6 <sup>[2,3]</sup>

Notes:

1. LED Engin maintains a tolerance of  $\pm 0.24\text{V}$  for forward voltage measurements.
2. All 4 white Channels have matched  $V_F$  for parallel operation
3. Forward Voltage is binned with 6 LED dies connected in series. The LED is configured with 4 Channels of 6 dies in series each.

## Absolute Maximum Ratings

Table 3:

Parameter	Symbol	Value	Unit
DC Forward Current at $T_{jmax}=135^{\circ}\text{C}$ <sup>[1]</sup>	$I_F$	1200	mA
DC Forward Current at $T_{jmax}=150^{\circ}\text{C}$ <sup>[1]</sup>	$I_F$	1000	mA
Peak Pulsed Forward Current <sup>[2]</sup>	$I_{FP}$	1500 /Channel	mA
Reverse Voltage	$V_R$	See Note 3	V
Storage Temperature	$T_{stg}$	-40 ~ +150	$^{\circ}\text{C}$
Junction Temperature	$T_J$	150	$^{\circ}\text{C}$
Soldering Temperature <sup>[4]</sup>	$T_{sol}$	260	$^{\circ}\text{C}$
Allowable Reflow Cycles		6	
ESD Sensitivity <sup>[5]</sup>		> 8,000 V HBM Class 3B JESD22-A114-D	

Notes:

- Maximum DC forward current (per die) is determined by the overall thermal resistance and ambient temperature. Follow the curves in Figure 10 for current de-rating.
- Pulse forward current conditions: Pulse Width  $\leq 10\text{msec}$  and Duty cycle  $\leq 10\%$ .
- LEDs are not designed to be reverse biased.
- Solder conditions per JEDEC 020D. See Reflow Soldering Profile Figure 5.
- LED Engin recommends taking reasonable precautions towards possible ESD damages and handling the LZP-00CW0R in an electrostatic protected area (EPA). An EPA may be adequately protected by ESD controls as outlined in ANSI/ESD S6.1.

## Optical Characteristics @ $T_C = 25^{\circ}\text{C}$

Table 4:

Parameter	Symbol	Typical	Unit
Luminous Flux (@ $I_F = 700\text{mA}$ ) <sup>[1]</sup>	$\Phi_V$	4400	lm
Luminous Flux (@ $I_F = 1000\text{mA}$ ) <sup>[1]</sup>	$\Phi_V$	5700	lm
Luminous Efficacy (@ $I_F = 350\text{mA}$ )		105	lm/W
Correlated Color Temperature	CCT	5500	K
Color Rendering Index (CRI)	$R_a$	75	
Viewing Angle <sup>[2]</sup>	$2\theta_{1/2}$	110	Degrees

Notes:

- Luminous flux typical value is for all 24 LED dies operating at rated current.
- Viewing Angle is the off-axis angle from emitter centerline where the luminous intensity is  $\frac{1}{2}$  of the peak value.

## Electrical Characteristics @ $T_C = 25^{\circ}\text{C}$

Table 5:

Parameter	Symbol	Typical	Unit
Forward Voltage (@ $I_F = 700\text{mA}$ ) <sup>[1]</sup>	$V_F$	18.9 /Channel	V
Forward Voltage (@ $I_F = 1000\text{mA}$ ) <sup>[1]</sup>	$V_F$	19.5 /Channel	V
Temperature Coefficient of Forward Voltage <sup>[1]</sup>	$\Delta V_F/\Delta T_J$	-16.8	mV/ $^{\circ}\text{C}$
Thermal Resistance (Junction to Case)	$R\theta_{J-C}$	0.6	$^{\circ}\text{C}/\text{W}$

Notes:

- Forward Voltage is measured for a single string of 6 dies connected in series. The LED is configured with 4 Channels of 6 dies in series each.

## IPC/JEDEC Moisture Sensitivity Level

Table 6 - IPC/JEDEC J-STD-20D.1 MSL Classification:

Level	Soak Requirements					
	Floor Life		Standard		Accelerated	
	Time	Conditions	Time (hrs)	Conditions	Time (hrs)	Conditions
1	unlimited	≤ 30°C/ 85% RH	168 +5/-0	85°C/ 85% RH	n/a	n/a

Notes:

- The standard soak time includes a default value of 24 hours for semiconductor manufacturer's exposure time (MET) between bake and bag and includes the maximum time allowed out of the bag at the distributor's facility.

## Average Lumen Maintenance Projections

Lumen maintenance generally describes the ability of a lamp to retain its output over time. The useful lifetime for solid state lighting devices (Power LEDs) is also defined as Lumen Maintenance, with the percentage of the original light output remaining at a defined time period. L70 defines the amount of operating hours at which the light output has reached 70% of its original output.

### 25 die (700mA & 1000mA, Rjc=0.6) L70 de-rating

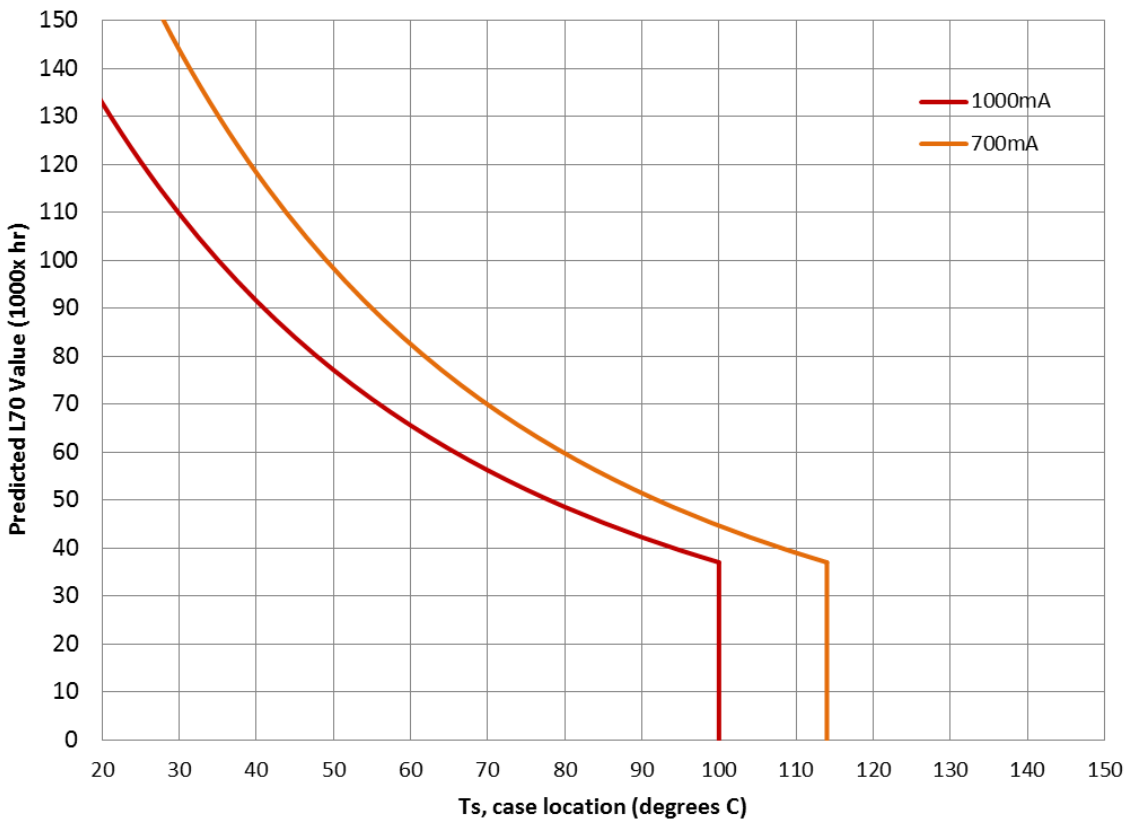

Figure 1: De-rating curve for operation of all dies at 700mA

Notes:

- Ts is a thermal reference point on the emitter case



## Mechanical Dimensions (mm)

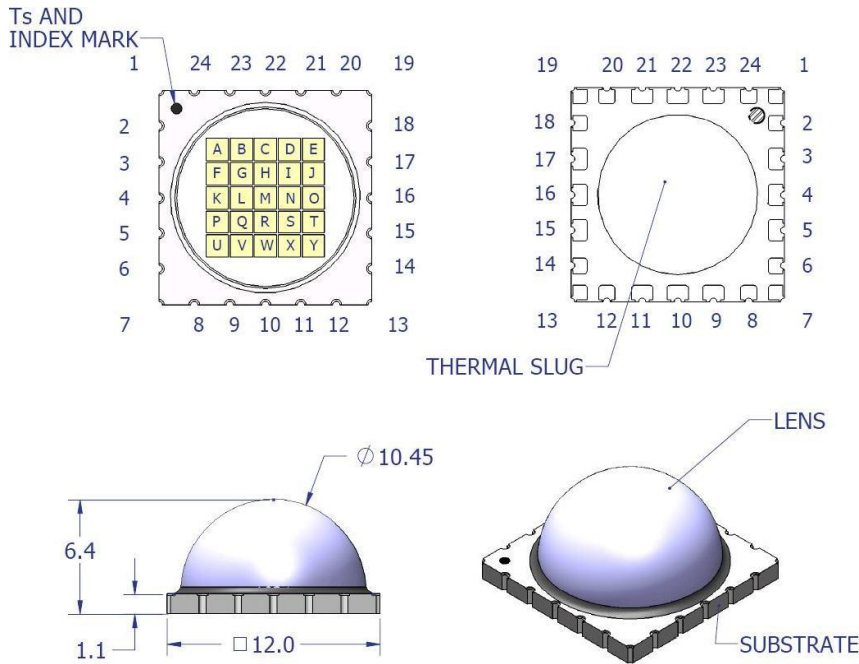

Figure 2: Package outline drawing.

### Notes:

1. LZP-00xW0R pin out polarity is reversed; therefore it is not compatible with MCPCB designed for LZP-00xW00 products, except for LZP-00SW00 and LZP-00GW00.
2. Index mark, Ts indicates case temperature measurement point.
3. Unless otherwise noted, the tolerance =  $\pm 0.20$  mm.
4. Thermal slug is electrically isolated

Pin Out				
Ch.	Pad	Die	Color	Function
1	18	E	CW	Cathode
		D	CW	na
		C	CW	na
		B	CW	na
		A	CW	na
		24	F	CW
2	17	J	CW	Cathode
		I	CW	na
		H	CW	na
		G	CW	na
		L	CW	na
		3	K	CW
3	15	O	CW	Cathode
		N	CW	na
		S	CW	na
		R	CW	na
		Q	CW	na
		5	P	CW
4	14	T	CW	Cathode
		Y	CW	na
		X	CW	na
		W	CW	na
		V	CW	na
		8	U	CW
5	2	M	-	na
	23	M	-	na

## Recommended Solder Pad Layout (mm)

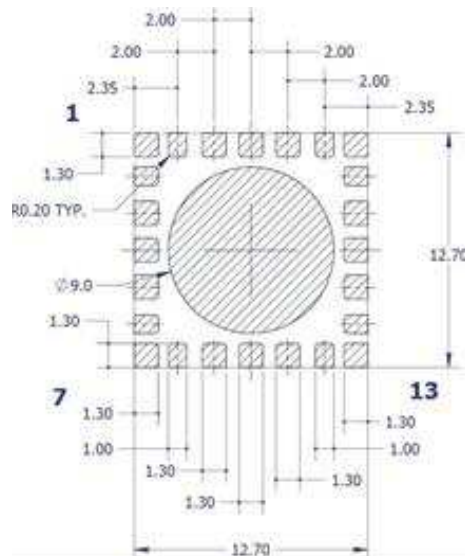
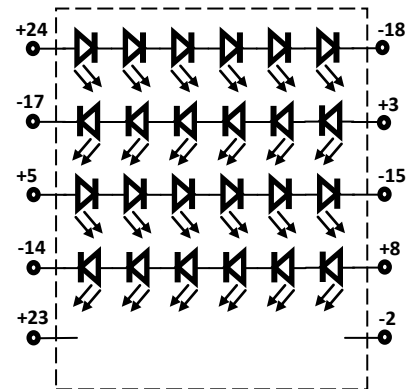

Figure 3: Recommended solder mask opening (hatched area) for anode, cathode, and thermal pad.

### Notes:

1. Unless otherwise noted, the tolerance =  $\pm 0.20$  mm.
2. LED Engin recommends the use of copper core MCPCB's which allow for the emitter thermal slug to be soldered directly to the copper core (so called pedestal design). Such MCPCB technologies eliminate the high thermal resistance dielectric layer that standard MCPCB technologies use in between the emitter thermal slug and the metal core of the MCPCB, thus lowering the overall system thermal resistance.
3. LED Engin recommends x-ray sample monitoring to screen for solder voids underneath the emitter thermal slug. The total area covered by solder voids should be less than 20% of the total emitter thermal slug area. Excessive solder voids will increase the emitter to MCPCB thermal resistance and may lead to higher failure rates due to thermal over stress.



## Reflow Soldering Profile

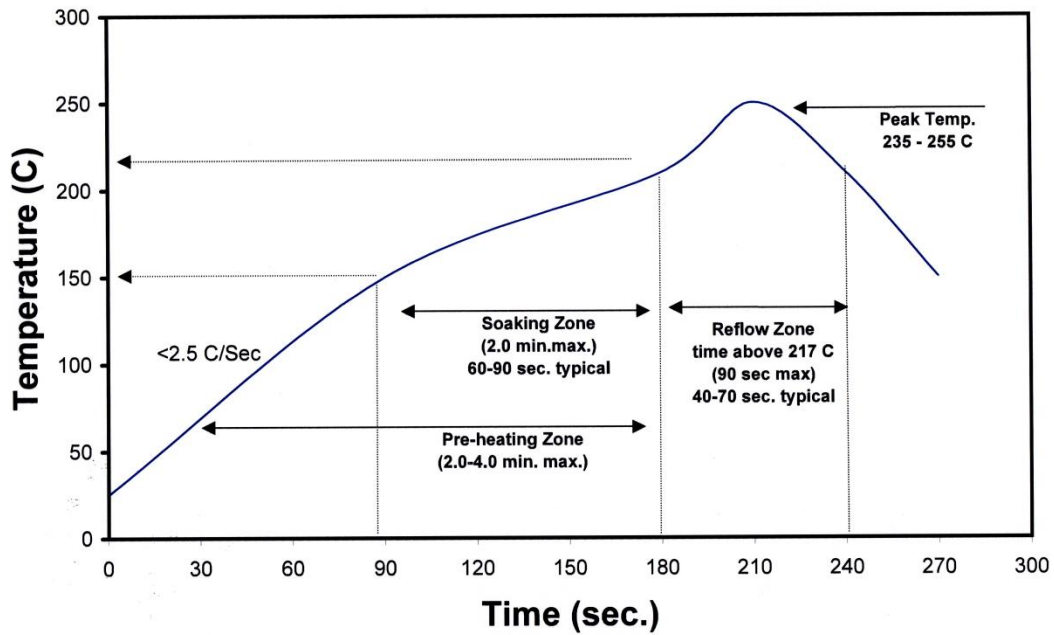

Figure 4: Reflow soldering profile for lead free soldering.

## Typical Radiation Pattern

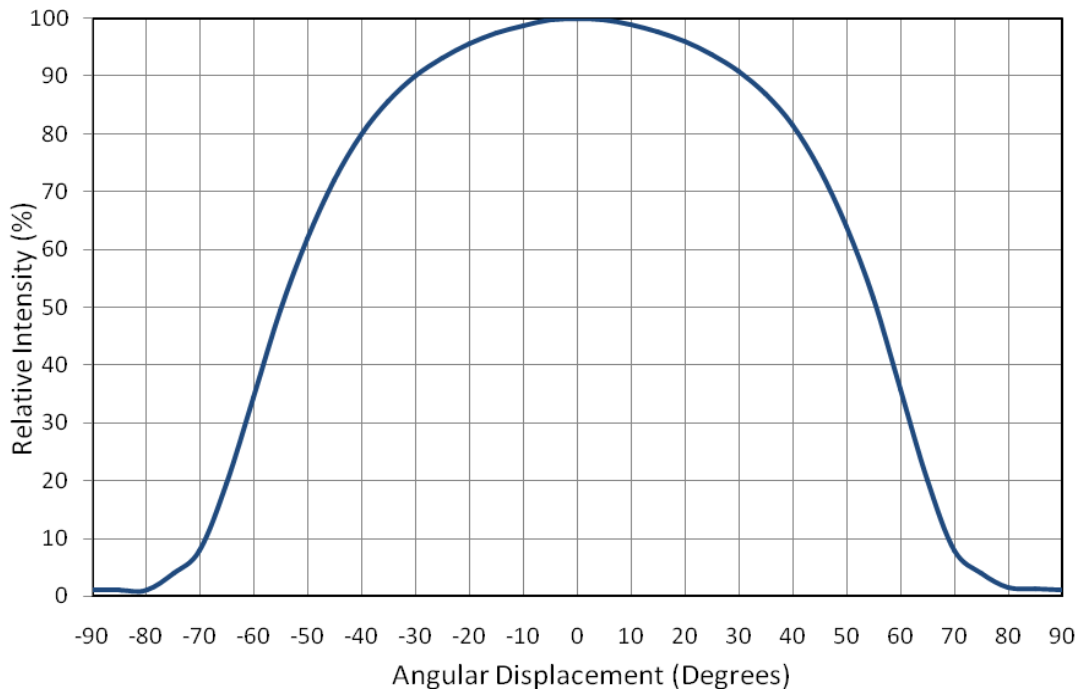

Figure 5: Typical representative spatial radiation pattern.

## Typical Relative Spectral Power Distribution

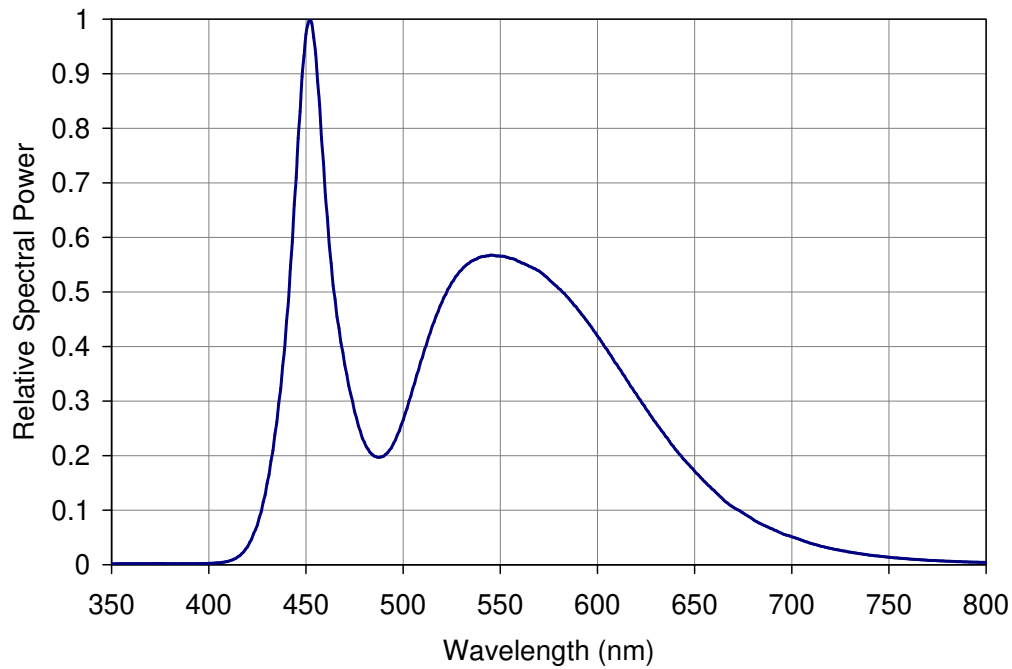

Figure 6: Typical relative spectral power vs. wavelength @  $T_c = 25^\circ\text{C}$ .

## Typical Forward Current Characteristics

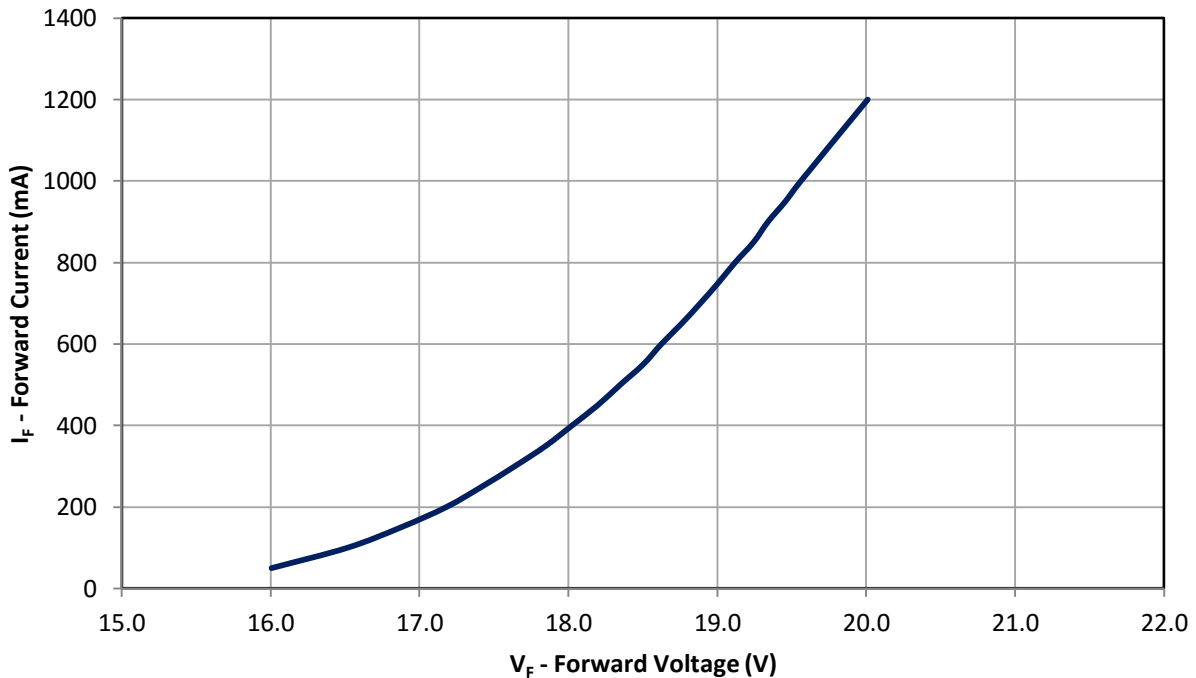

Figure 7: Typical forward current vs. forward voltage @  $T_c = 25^\circ\text{C}$ .

Note:

1. Forward Voltage is measured for a single string of 6 dies connected in series. The LED is configured with 4 Channels of 6 dies in series each.

### Typical Relative Light Output over Forward Current

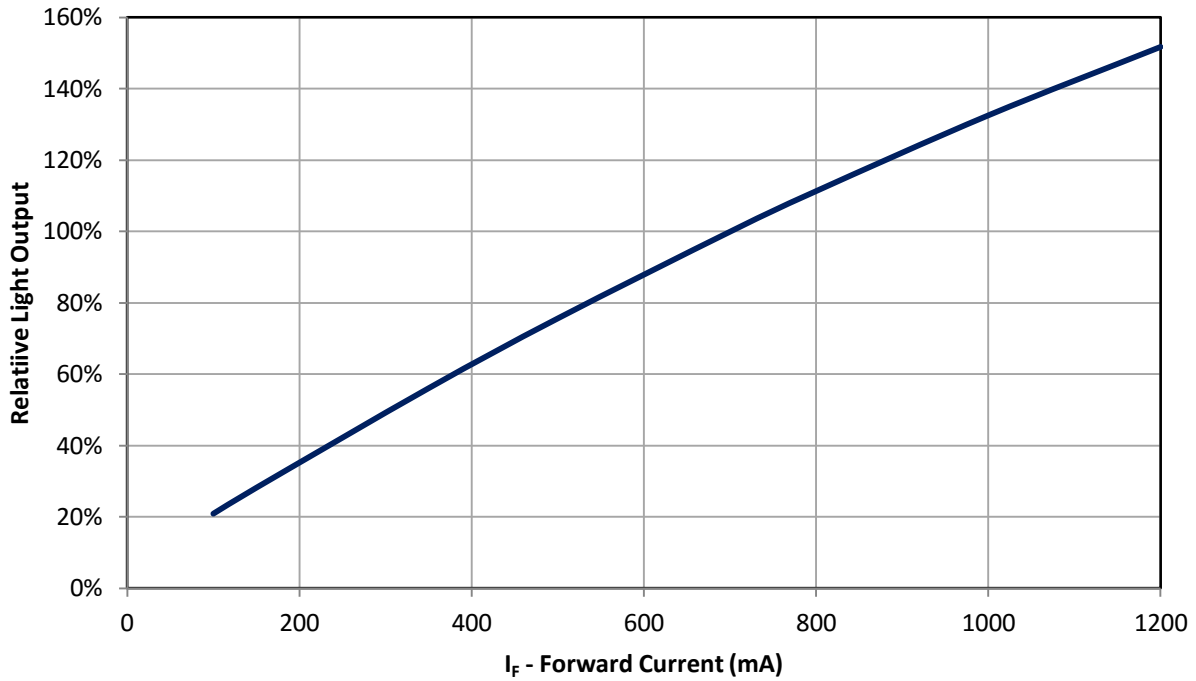

Figure 8: Typical relative light output vs. forward current @  $T_c = 25^\circ\text{C}$ .

Notes:

1. Luminous Flux typical value is for all 24 LED dies operating concurrently at rated current per Channel.

### Typical Relative Light Output over Temperature

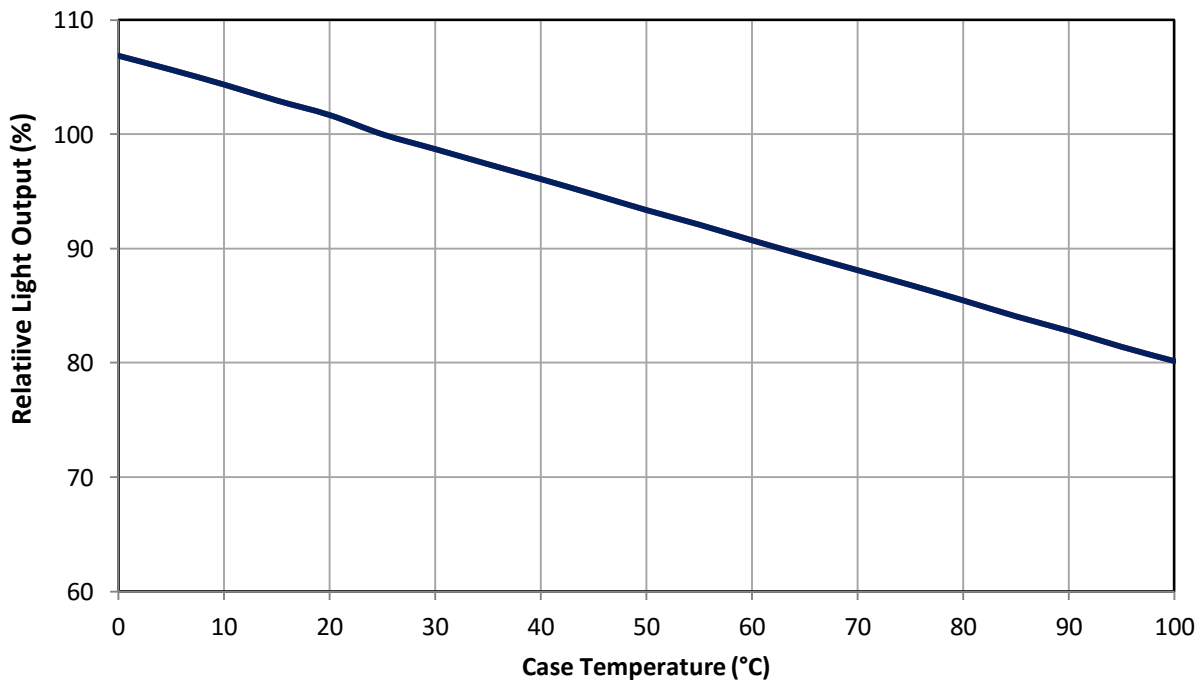

Figure 9: Typical relative light output vs. case temperature.

Notes:

1. Luminous Flux typical value is for all 24 LED dies operating concurrently at rated current per Channel.

### Current De-rating

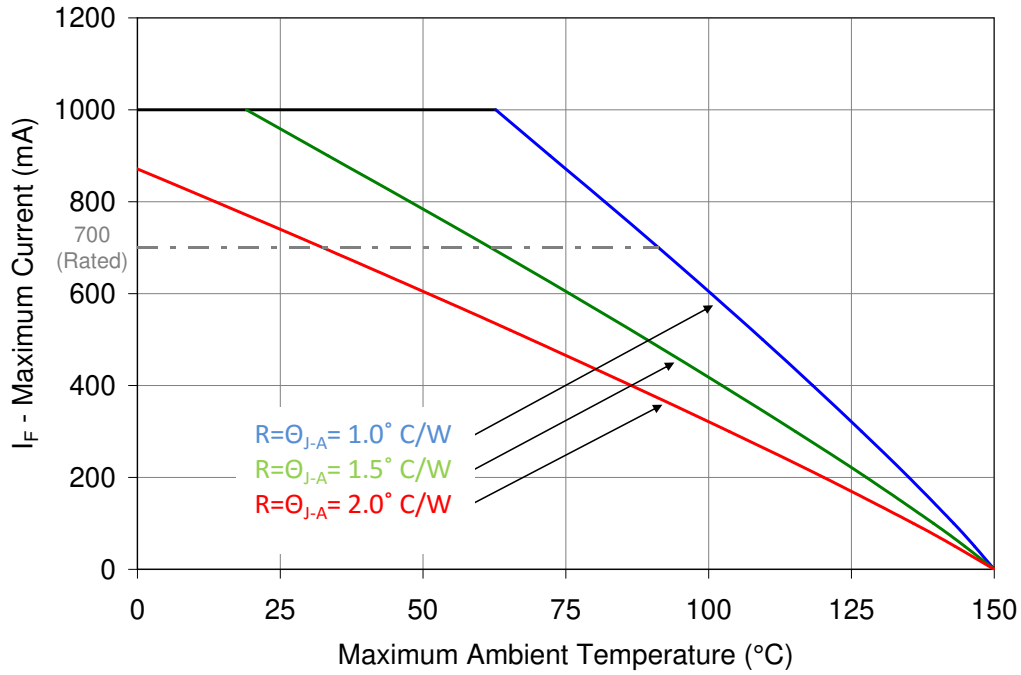

Figure 10: Maximum forward current vs. ambient temperature based on  $T_{J(\text{MAX})} = 150^\circ\text{C}$ .

Notes:

1. Maximum current assumes that all LED dies are operating at rated current.
2.  $R\Theta_{J-C}$  [Junction to Case Thermal Resistance] for the LZP-series is typically  $0.6^\circ\text{C/W}$ .
3.  $R\Theta_{J-A}$  [Junction to Ambient Thermal Resistance] =  $R\Theta_{J-C} + R\Theta_{C-A}$  [Case to Ambient Thermal Resistance].

# LZP MCPCB Family

Part number	Type of MCPCB	Diameter (mm)	Emitter + MCPCB Thermal Resistance (°C/W)	Typical V <sub>f</sub> (V)	Typical I <sub>f</sub> (mA)
LZP-DxxxxR	5-channel (4x6+1 strings)	28.3	0.6 + 0.1 = 0.7	18.9	4 x 700

## Mechanical Mounting of MCPCB

- MCPCB bending should be avoided as it will cause mechanical stress on the emitter, which could lead to substrate cracking and subsequently LED dies cracking.
- To avoid MCPCB bending:
  - Special attention needs to be paid to the flatness of the heat sink surface and the torque on the screws.
  - Care must be taken when securing the board to the heat sink. This can be done by tightening three M3 screws (or #4-40) in steps and not all the way through at once. Using fewer than three screws will increase the likelihood of board bending.
  - It is recommended to always use plastics washers in combinations with the three screws.
  - If non-taped holes are used with self-tapping screws, it is advised to back out the screws slightly after tightening (with controlled torque) and then re-tighten the screws again.

## Thermal interface material

- To properly transfer heat from LED emitter to heat sink, a thermally conductive material is required when mounting the MCPCB on to the heat sink.
- There are several varieties of such material: thermal paste, thermal pads, phase change materials and thermal epoxies. An example of such material is Electrolube EHTC.
- It is critical to verify the material's thermal resistance to be sufficient for the selected emitter and its operating conditions.

## Wire soldering

- To ease soldering wire to MCPCB process, it is advised to preheat the MCPCB on a hot plate of 125-150°C. Subsequently, apply the solder and additional heat from the solder iron will initiate a good solder reflow. It is recommended to use a solder iron of more than 60W.
- It is advised to use lead-free, no-clean solder. For example: SN-96.5 AG-3.0 CU 0.5 #58/275 from Kester (pn: 24-7068-7601)



# LZP-DxxxxR

## 5-channel, Standard Star MCPCB (4x6+1) Mechanical Dimensions (mm)

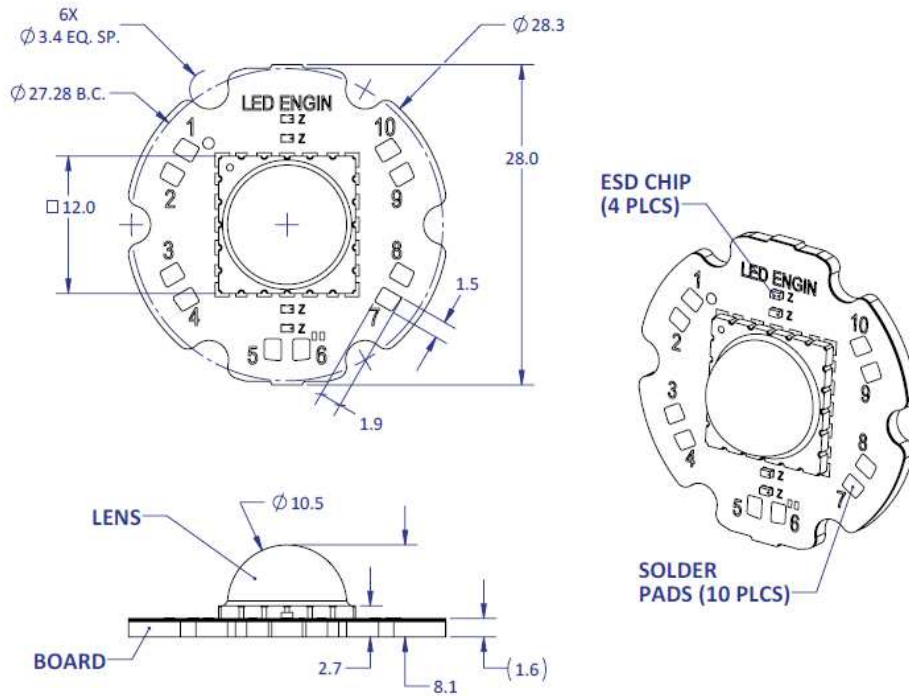

**Notes:**

- Unless otherwise noted, the tolerance =  $\pm 0.20$  mm.
- Slots in MCPCB are for M3 or #4 mounting screws.
- LED Engin recommends using plastic washers to electrically insulate screws from solder pads and electrical traces.
- LED Engin recommends using thermal interface material when attaching the MCPCB to a heat sink.
- LED Engin uses a copper core MCPCB with pedestal design, allowing direct solder connect between the MCPCB copper core and the emitter thermal slug. The thermal resistance of this copper core MCPCB is: R $\theta$ C-B 0.1°C/W

## Components used

MCPCB: SuperMCPCB (Bridge Semiconductor, copper core with pedestal design)  
 ESD chips: BZT52C36LP (NXP, for 6 LED dies in series)

Pad layout			
Ch.	MCPCB Pad	String/die	Function
1	1	1/EDCBAF	Anode +
	10		Cathode -
2	2	2/JIHGLK	Anode +
	9		Cathode -
3	3	3/ONSRQP	Anode +
	8		Cathode -
4	4	4/TYXWVU	Anode +
	7		Cathode -
5	5	5/M	N/A
	6		N/A

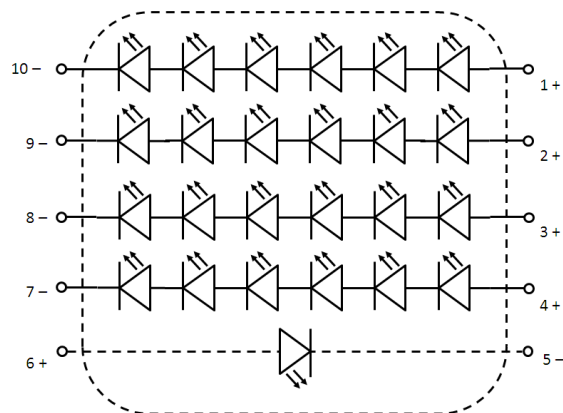

## Company Information

LED Engin, based in California's Silicon Valley, develops, manufactures, and sells advanced LED emitters, optics and light engines to create uncompromised lighting experiences for a wide range of entertainment, architectural, general lighting and specialty applications. LuxiGen™ multi-die emitter and secondary lens combinations reliably deliver industry-leading flux density, upwards of 5000 quality lumens to a target, in a wide spectrum of colors including whites, tunable whites, multi-color and UV LEDs in a unique patented compact ceramic package. Our LuxiTune™ series of tunable white lighting modules leverage our LuxiGen emitters and lenses to deliver quality, control, freedom and high density tunable white light solutions for a broad range of new recessed and downlighting applications. The small size, yet remarkably powerful beam output and superior in-source color mixing, allows for a previously unobtainable freedom of design wherever high-flux density, directional light is required.

LED Engin is committed to providing products that conserve natural resources and reduce greenhouse emissions.

LED Engin reserves the right to make changes to improve performance without notice.

Please contact [sales@ledengin.com](mailto:sales@ledengin.com) or (408) 922-7200 for more information.