



Chipsmall Limited consists of a professional team with an average of over 10 year of expertise in the distribution of electronic components. Based in Hongkong, we have already established firm and mutual-benefit business relationships with customers from,Europe,America and south Asia,supplying obsolete and hard-to-find components to meet their specific needs.

With the principle of "Quality Parts,Customers Priority,Honest Operation,and Considerate Service",our business mainly focus on the distribution of electronic components. Line cards we deal with include Microchip,ALPS,ROHM,Xilinx,Pulse,ON,Everlight and Freescale. Main products comprise IC,Modules,Potentiometer,IC Socket,Relay,Connector.Our parts cover such applications as commercial,industrial, and automotives areas.

We are looking forward to setting up business relationship with you and hope to provide you with the best service and solution. Let us make a better world for our industry!



## Contact us

Tel: +86-755-8981 8866 Fax: +86-755-8427 6832

Email & Skype: info@chipsmall.com Web: www.chipsmall.com

Address: A1208, Overseas Decoration Building, #122 Zhenhua RD., Futian, Shenzhen, China



## M21324 SD, HD, 2xHD Cable Equalizer

The M21324 is a high-speed, low-power, adaptive co-axial cable equalizers designed to increase the maximum low-jitter transmission distance of serial digital interface (SDI) video signals and DVB-ASI across commonly used bandwidth-limiting 75Ω coaxial cable. This device automatically optimizes the transfer function based on the bit rate and cable length to minimize the inter-symbol interference (ISI) jitter caused by the cable and to remove the DC offset components introduced with the pathological test pattern and AC coupling in systems.

The M21324 is designed to support 2xHD data rates from 143 Mbps to 2970 Mbps.

The low-noise, high-gain equalizer allows for low jitter 2xHD transmissions up to 100m (Belden 1694A) and HD transmissions up to a length of 200m (Belden 1694A) and 120m (Belden 8281). For SD data rates, cable lengths up to 400m (Belden 1694A) and 300m (Belden 8281) are supported.

The M21324 shares the same footprint as the GS2974A, GS1574/GS1574A or GS9074A, except that the M21324 has a shared Signal Detect/Mute function pin, while the GS2974A, GS1574/1574A and GS9074A have separate CD and mute pins.

### Applications

- SMPTE Coaxial Cable Interface
- Studio video applications
- Broadcast video applications
- Distribution video applications

### Standards Compliance

- SMPTE 259M, SMPTE 292M, SMPTE 344M, SMPTE 424M complaint
- Supports DVB-ASI (270 Mbps)

### Features

- Adaptive cable equalization
- Optimized data rate from 143 Mbps to 2.97 Gbps
- Typical equalized length of Belden 1694A cable: 100m at 2.97 Gbps, 200m at 1.485 Gbps, and 400m at 270 Mbps
- Programmable mute level
- Manual bypass mode
- Differential CML outputs (50 Ω on-chip terminations)
- Single 3.3V power supply
- Small form factor (4x4mm, 16-pin MLF package)
- Pb-free and RoHS compliant
- Extended operating temperature range: -10 to +85 °C

Functional Block Diagram

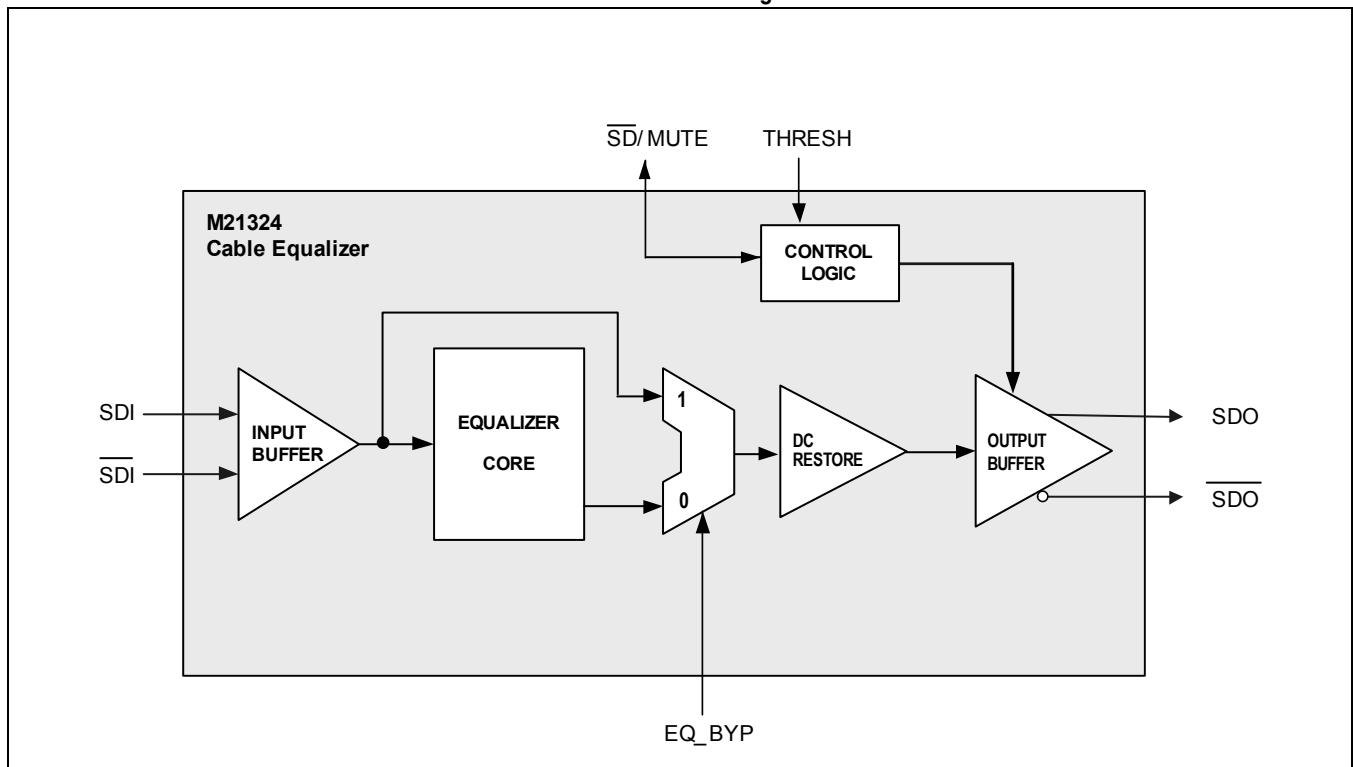

## Ordering Information

Part Number	Package	Operating Data Rate	Operating Temperature
M21324G-13*	16-pin MLF (RoHS compliant)	143–2970 Mbps	–10 °C to 85 °C

\* Consult the price list for exact part number when ordering.

\* The letter 'G' designator after the part number indicates a RoHS-compliant package. Refer to [www.mindspeed.com](http://www.mindspeed.com) for additional information.

## Revision History

Revision	Level	Date	Description
C	Released	November 2009	Updated for -13 part. Added marking diagram.
B	Released	August 2007	Added $\theta_{JA}$ (Junction to Ambient Thermal Resistance) to <a href="#">Table 1-2</a> .
A	Preliminary	August 2007	Preliminary Release.

### M21324 Marking Diagram

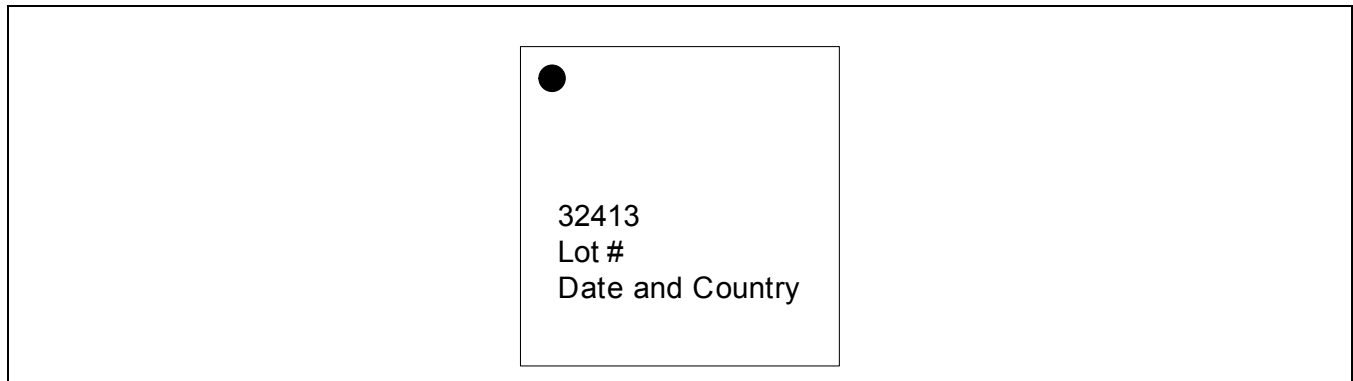



# Table of Contents

---

Ordering Information	2
Revision History	2
Table of Contents	3
List of Figures	4
List of Tables	5
1.0 Product Specification	6
1.1 General Specifications	6
1.2 Input/Output Level Specifications	7
1.3 EQ Specifications	10
1.4 Package Specification	11
1.4.1 Mechanical Description	12
1.5 Manufactureability	13
1.5.1 Electrostatic Discharge	13
1.5.2 Peak Reflow Temperature	13
1.5.3 Moisture Sensitivity Level (MSL)	13
1.6 Design Considerations	13
1.6.1 Thermal Considerations	13
2.0 Functional Description	14
2.1 Pin Descriptions	14
2.1.1 General Nomenclature	14
2.1.2 High-Speed Input	14
2.1.3 High-Speed Outputs	15
2.1.4 Adaptive Equalization Selection	15
2.1.5 Output Mute and Signal Detect	15
2.1.6 Equalizer Detailed Description	15
2.2 M21324 Common Signals by Interface Group	16
2.2.1 M21324 Pins	17
Appendix	18
A.1 Glossary of Terms/Acronyms	18
A.2 Reference Documents	19
A.2.1 External	19



# List of Figures

---

Figure 1-1. Output Symbols Definition .....	9
Figure 1-2. M21324 Pin Assignments. ....	11
Figure 1-3. M21324 Packaging Details .....	12
Figure 2-1. Single-ended Typical Input Matching/Termination Network .....	14
Figure 2-2. Test Setup Diagram for Cable Equalizer Evaluation. ....	16



# List of Tables

---

Table 1-1.	Absolute Maximum Ratings . . . . .	6
Table 1-2.	Recommended Operating Conditions . . . . .	6
Table 1-3.	Power DC Electrical Specifications . . . . .	6
Table 1-4.	CMOS Input Electrical Specifications (Logic Signals Only) . . . . .	7
Table 1-5.	High Speed Input Electrical Specifications . . . . .	7
Table 1-6.	High Speed Output Electrical Specifications . . . . .	8
Table 1-7.	Cable Equalizer Distance Specifications . . . . .	10
Table 1-8.	SD/MUTE Specifications . . . . .	10
Table 2-1.	Power Pins . . . . .	16
Table 2-2.	High-speed Signal Pins . . . . .	16
Table 2-3.	Control/Interface Pins . . . . .	17



# 1.0 Product Specification

## 1.1 General Specifications

**Table 1-1. Absolute Maximum Ratings**

Symbol	Parameter	Minimum	Maximum	Units
$AV_{DD}$	Positive Supply	$AV_{SS} - 0.5$	$AV_{SS} + 3.6$	V
$V_{IOAM}$	Any I/O pin	$AV_{SS} - 0.5$	$AV_{DD} + 0.5$	V
$T_{STORE}$	Storage Temperature	-65	+150	°C
$ESD_{HBML}$	Human Body Model (low-speed)	2000	—	V
$ESD_{HBMH}$	Human Body Model (high-speed)	2000	—	V
$ESD_{CDM}$	Charge Device Model	500	—	V

**NOTE:**  
1. No Damage.

**Table 1-2. Recommended Operating Conditions**

Symbol	Parameter	Notes	Minimum	Typical	Maximum	Units
$AV_{DD}$	Supply Voltage	—	-5	3.3	+5	%
$T_{AMB}$	Ambient Temperature	—	-10	—	+85	°C
$\theta_{JA}$	Junction to Ambient Thermal Resistance	1, 2	—	44.5	—	°C/W

**NOTES:**  
1. Mounted on multi layer board ( $\geq 4$  layers).  
2. Airflow = 0.0 m/s.

**Table 1-3. Power DC Electrical Specifications**

Symbol	Parameter	Notes	Minimum	Typical	Maximum	Units
Total $I_{DD}$	Supply Current	1	—	70	90	mA
$P_{DISS}$	Total Power Dissipation (@3.3V)	1, 2, 3	—	230	312	mW

**NOTES:**  
1. Specified at recommended operating conditions—see [Table 1-2](#).  
2. Includes on-chip power dissipation as well as off-chip power dissipated by termination resistors.  
3. Typical calculated at nominal supply voltage, maximum calculated at nominal supply voltage + 5%.

## 1.2 Input/Output Level Specifications

**Table 1-4. CMOS Input Electrical Specifications (Logic Signals Only)**

Symbol	Parameter	Notes	Minimum	Typical	Maximum	Units
$V_{IH}$	Input Logic High Voltage	1	$0.75 \times AV_{DD}$	—	$AV_{DD} + 0.3$	V
$V_{IL}$	Input Logic Low Voltage	1	0	—	$0.25 \times AV_{DD}$	V
$I_{IH}$	Input Current (logic high)	1	-100	—	100	$\mu A$
$I_{IL}$	Input Current (logic low)	1	-100	—	100	$\mu A$

**NOTE:**

- Specified at recommended operating conditions—see [Table 1-2](#). Spec is for a max load of 20 pF.

**Table 1-5. High Speed Input Electrical Specifications**

Symbol	Parameter	Notes	Minimum	Typical	Maximum	Units
$DR_{IN}$	Input Bit Rate	1	143	—	2970	Mbps
$V_{ID}$	Input Voltage Range with 0m of cable, p-p	1, 5	700	800	1200	mV
$V_{ICM}$	Input Common-Mode Voltage	1, 4	—	2.75	—	V
$C_{IN}$	Input capacitance	1, 4	—	0.5	—	pF
$R_{IN}$	Input resistance	1, 4	—	1.6	—	k $\Omega$
$S_{11}$	Input Return Loss (5 MHz to 1.5 GHz)	1, 2, 3	20	30	—	dB
	Input Return Loss (1.5 GHz to 3 GHz)	1, 2, 3	—	13	—	dB

**NOTES:**

- Specified at recommended operation conditions—see [Table 1-2](#).
- Using the recommended input termination shown in [Figure 2-1](#).
- Measured single ended.
- Guaranteed by design.
- This is also the recommended cable launch level (far end).



**Table 1-6. High Speed Output Electrical Specifications**

Symbol	Parameter	Notes	Minimum	Typical	Maximum	Units
$t_r/t_f$	Rise/Fall Time (20%–80%)	1, 2, 7	—	100	120	ps
$t_r/t_{fmm}$	Rise/Fall Time Mismatch	1, 2, 7	—	0	30	ps
$DCD_O$	Duty Cycle Distortion (DCD)	1, 2, 5, 6	—	0	15	ps
$V_{OD}$	Differential Output Voltage p-p	1, 3	600	750	950	mV
$V_{OCM}$	Common mode Voltage	1, 3, 4	—	$AV_{DD} - 0.205$	—	V
$Z_O$	Internal Output Termination Resistance to $AV_{DD}$	1	40	50	60	$\Omega$

**NOTES:**

- Specified at recommended operation conditions— see [Table 1-2](#).
- With 100 $\Omega$  differential termination.
- With 50 $\Omega$  to  $AV_{DD}$  termination.
- Outputs DC-coupled.
- Duty Cycle Distortion (DCD) is defined as the difference in the intrinsic jitter at the 50% voltage level and the intrinsic jitter at the rising/falling edge crossing point. If the rising/falling edge crossing point is at the 50% voltage level, then DCD = 0.
- Measured with a 1010 pattern.
- Measured with a PRBS23 pattern.

Figure 1-1. Output Symbols Definition

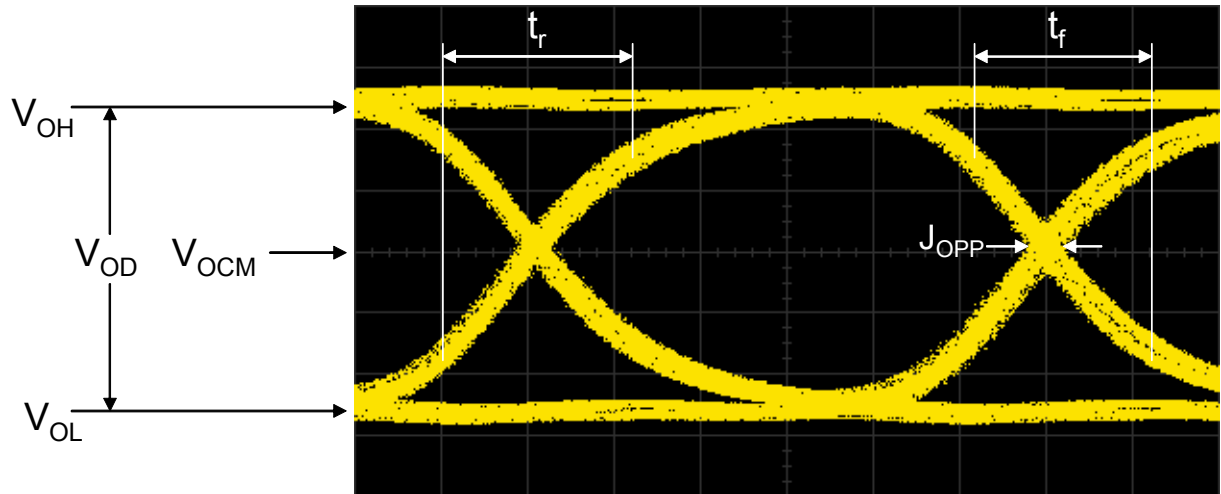

- $V_{OH}$ : Average voltage high level
- $V_{OL}$ : Average voltage low level
- $V_{OD}$ :  $(V_{OH}) - (V_{OL})$
- $V_{OCM}$ : Common Mode Voltage
- $J_{OPP}$ : Output Jitter Peak-Peak
- $t_r$ : 20-80% Rise Time
- $t_f$ : 80-20% Fall Time

**NOTE:** Waveform above is differential.

### 1.3 EQ Specifications

**Table 1-7. Cable Equalizer Distance Specifications**

Symbol	Parameter	Conditions	Notes	Minimum	Typical	Maximum	Units
LEN <sub>SD</sub>	Max Cable Length	Belden 1694A	1, 4	—	400	—	m
	Max Cable Length	Belden 8281	1, 4	—	300	—	m
LEN <sub>HD</sub>	Max Cable Length	Belden 1694A	2, 6	—	200	—	m
	Max Cable Length	Belden 1694A	2, 5	—	140	—	m
	Max Cable Length	Belden 8281	2, 5	—	120	—	m
LEN <sub>2xHD</sub>	Max Cable Length	Belden 1694A	3, 7	—	100	—	m

**NOTES:**

Entire table specified at recommended operating conditions— see [Table 1-2](#).

1. Data Rate = 270 Mbps.
2. Data Rate = 1485 Mbps.
3. Data Rate = 2970 Mbps.
4. Error Free with timing Jitter typically = 0.2 UI, pathological pattern.
5. Error Free with alignment Jitter typically = 0.25 UI, pathological pattern.
6. Error Free with alignment jitter typically = 0.3 UI, pathological pattern.
7. Error Free with alignment Jitter typically = 0.35 UI, pathological pattern.

**Table 1-8.  $\overline{SD}$ /MUTE Specifications**

Symbol	Parameter	Notes	Minimum	Typical	Maximum	Units
V <sub>MUT_LO</sub>	Output voltage when input signal detected	1	—	0.16 x AV <sub>DD</sub>	—	V
V <sub>MUT_HI</sub>	Output voltage when input signal not detected	1	—	0.95 x AV <sub>DD</sub>	—	V

**NOTE:**

1. Specified at recommended operating condition— see [Table 1-2](#).

## 1.4 Package Specification

The pin assignment is illustrated in [Figure 1-2](#). The M21324 package is RoHS compliant. This package is backwards compatible with the standard soldering techniques as defined in JEDEC-STD-020C (SnPb Process).

**Figure 1-2. M21324 Pin Assignments**

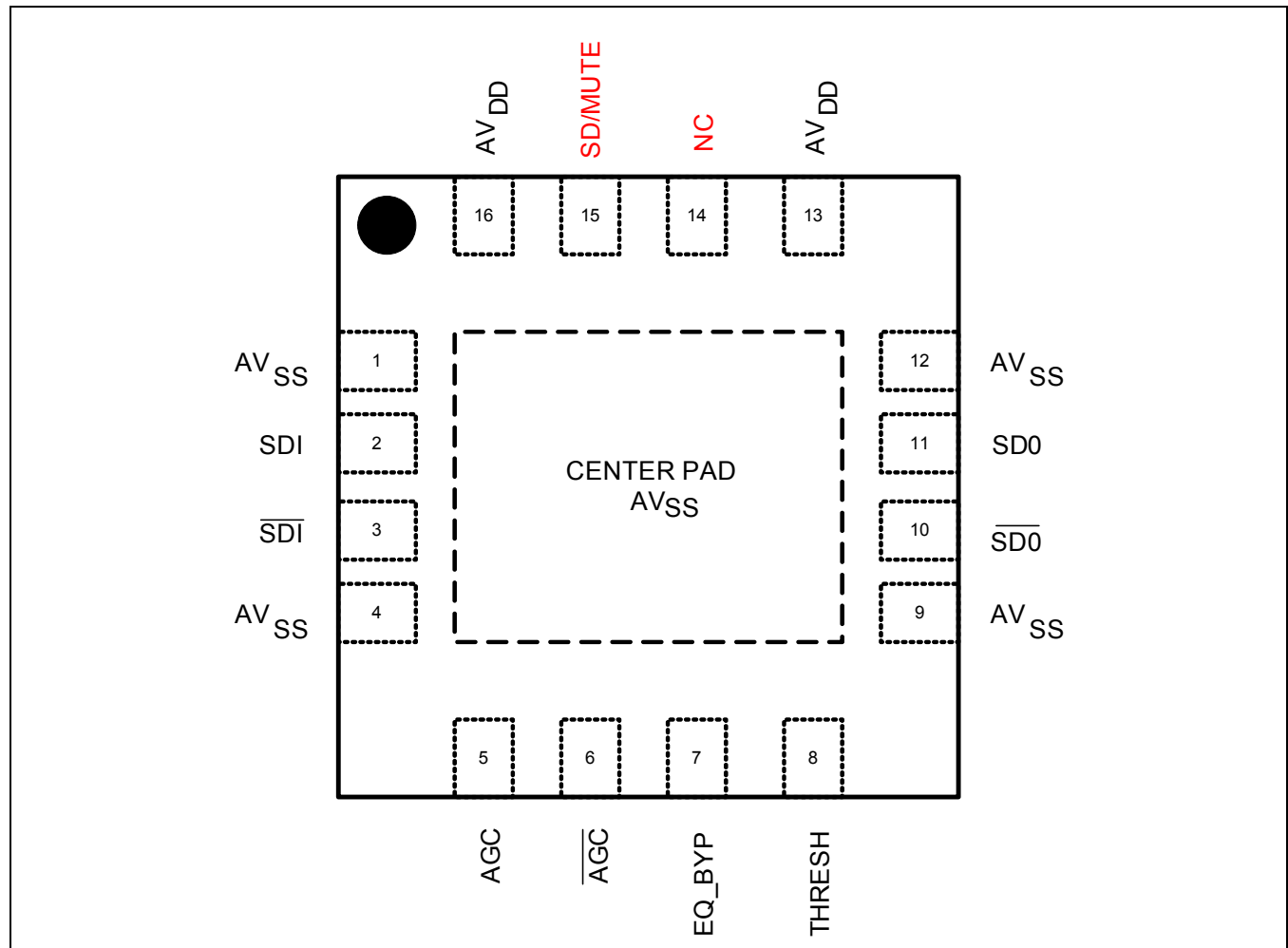

### 1.4.1 Mechanical Description

The package for the M21324 is illustrated in [Figure 1-3](#) below.

**Figure 1-3. M21324 Packaging Details**

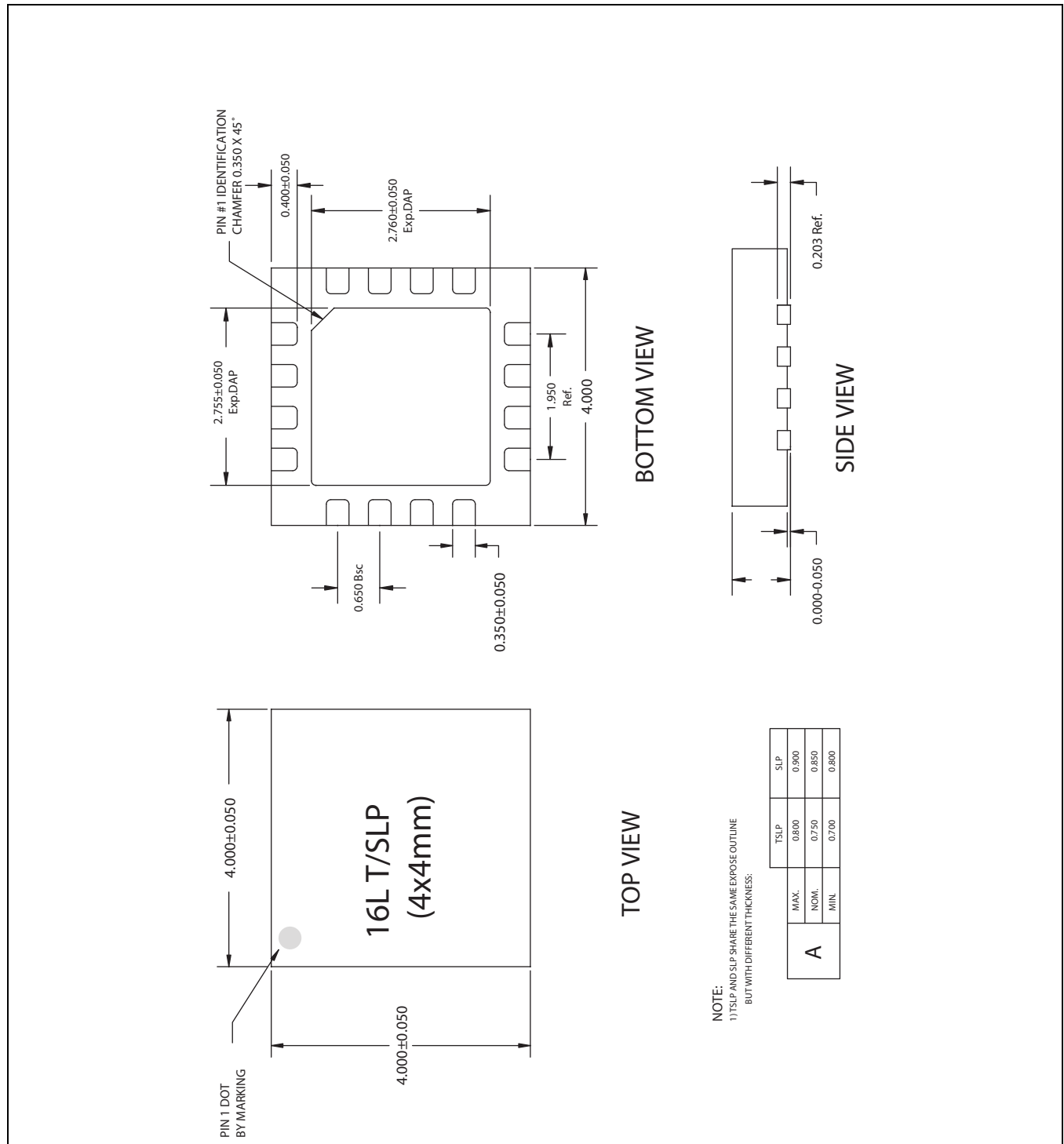

Please see Amkor's Application Note for PCB footprint (referenced in the [Section A.2.1](#)).

## 1.5 Manufactureability

The values shown in this section may change; however, these are standard requirements.

### 1.5.1 Electrostatic Discharge

Tested per JESD22-A114. This device passes 2000V of ESD Human Body Model (HBM) testing.  
Tested per JESD22-C101. This device passes 500V of ESD Charged Device Model (CDM) testing.  
Tested per EIA/JESD78. This device passes 150mA of trigger current at 85°C during Latchup testing.

### 1.5.2 Peak Reflow Temperature

M21324G (RoHS compliant package): Peak reflow temperature is 260°C per JEDEC standards.

### 1.5.3 Moisture Sensitivity Level (MSL)

All versions of this device (Std Pb-type and RoHS compliant packages) are Moisture Sensitivity Level (MSL) 3 per J-STD-020B and J-STD-033.

## 1.6 Design Considerations

See Digital Video Interfacing Application Note (212xx-APP-001-A) for guidance on the following:

- Component Placement and Layout
- Routing Considerations

### 1.6.1 Thermal Considerations

The M21324 consumes less power than legacy devices, therefore they will contribute less thermal energy and should result in a lower operating temperature.



## 2.0 Functional Description

### 2.1 Pin Descriptions

#### 2.1.1 General Nomenclature

Throughout this data sheet, physical pins will be denoted in **BOLD** print.

#### 2.1.2 High-Speed Input

Digital video coaxial cables are AC-coupled to the high-speed low-noise inputs, **SDI**/ **$\overline{\text{SDI}}$** , which, are designed to operate in both the single-ended or differential mode. The typical application is single-ended into the non-inverting **SDI** input with the inverting  **$\overline{\text{SDI}}$**  input biased to match the bias on the input used.

The M21324 does not contain any internal input terminations and require both external input termination as well as the matching circuit to exceed the SMPTE input return loss specifications. The package and IC design of the M21324 has been optimized for high-speed performance, allowing them to exceed the SD/HD SMPTE return loss spec by 5 dB to 10 dB, using the recommended external matching/termination network and commonly employed right-angle, through-hole, or vertical mount 75 $\Omega$  BNC connectors. For non-inverting single-ended operation, the recommended input circuit is shown in [Figure 2-1](#). For differential operation, the matching/termination circuit on **SDI** should be duplicated on  **$\overline{\text{SDI}}$** . The internal pull ups automatically bias **SDI**/ **$\overline{\text{SDI}}$**  for proper AC coupled operation.

**Figure 2-1. Single-ended Typical Input Matching/Termination Network**

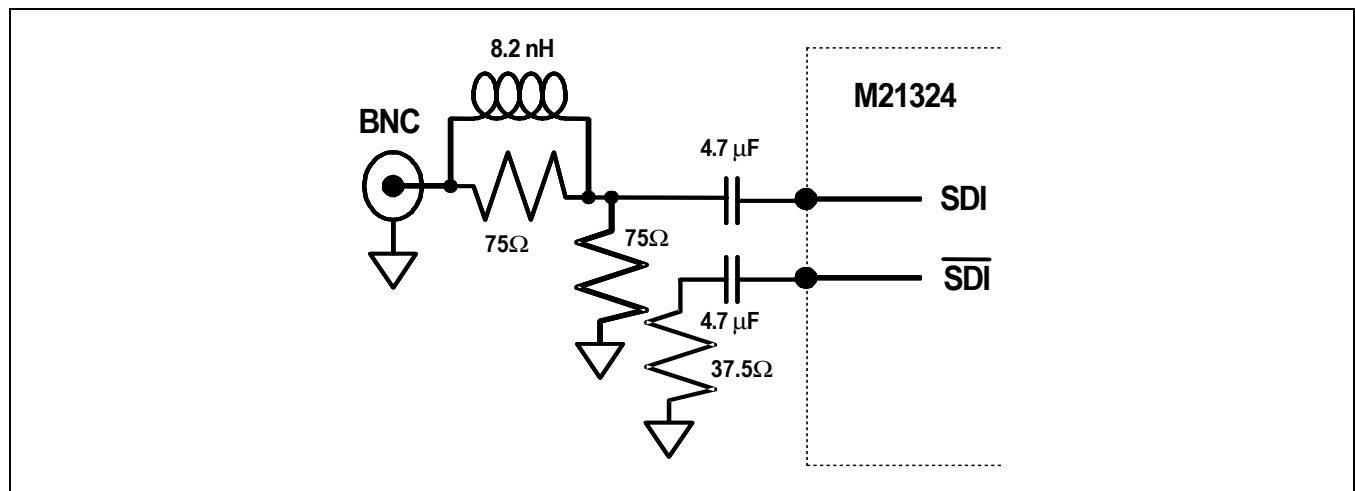

### 2.1.3 High-Speed Outputs

The high-speed differential outputs after equalization are made available on the **SDO/SDO** pins. The output swing and common-mode is compatible with the GS2974/GS2974A, GS1574/GS1574A and GS9074A.

### 2.1.4 Adaptive Equalization Selection

In typical operation, the adaptive equalization is enabled with **EQ\_BYP** = Low; however, with **EQ\_BYP** = High, the adaptive equalization and DC restore circuit is bypassed and the input is fed directly to the output.

### 2.1.5 Output Mute and Signal Detect

When configured as an input by forcing a voltage on  $\overline{\text{SD/MUTE}}$  = High (Vdd), the output of the M21324 will be inhibited at logic low (outputs muted). When  $\overline{\text{SD/MUTE}}$  = Low (Vss), the output is never muted and the programmable cable length based mute function is disabled.

When tied to a high-impedance input or left floating, the programmable inhibit based on cable length is enabled and the pin is defined as an LOS output (logic). In the event of an LOS, the output is muted. The inhibit threshold is set with an analog voltage applied to the **THRESH** input pin, this threshold will depend on cable type (e.g. Belden 1694A or 8281). To achieve maximum cable length equalization, the **THRESH** pin should be left open. Decoupling capacitors should be used between the **THRESH** pin and GND.

### 2.1.6 Equalizer Detailed Description

The basic equalizer design consists of interlaced stages of gain and equalization to maximize both the overall equalization gain as well as the input sensitivity for maximum performance with minimum jitter. In order to achieve maximum distance at 270 Mbps, 1485 Mbps and 2970 Mbps with Belden 1694A, the overall equalizer block has over 50 dB of broadband signal boost and maintains an input sensitivity of approximately 10 mV. Using a high-performance silicon process, high gain-bandwidth products are achieved allowing for high-performance, wide dynamic range design with minimum power dissipation.

Since signals are launched with different SMPTE specified rise and fall times which can vary substantially (especially at the receive end after going through a wide dynamic range of valid cable lengths) the equalization routine determines both the bit rate and the resultant signal HF attenuation as opposed to just looking at the launch edge rates. By determining both sets of conditions, it is possible to optimize the equalizer for the different rates. For example, the M21324 maintains the same maximum cable length as optimized SD only equalizers. An SD signal through a short cable can have the same edge rate as a HD signal through a long cable; yet, both conditions require different levels of equalization as well as different optimized inverse-transfer functions. The advanced equalization technology can make the distinction between the two cases for optimal performance. This also leads to proper mute threshold (**THRESH**) that is independent of the bit rate.

In order to accommodate both the SMPTE worst case equalizer pathological patterns as well as some customer derived worst case DC offset patterns, a high-gain slicer is included in the signal path to correct for any eye-crossing wander due to AC coupling of the input. [Figure 2-2](#) shows the test setup used by Mindspeed to evaluate the performance of the M21324.



Figure 2-2. Test Setup Diagram for Cable Equalizer Evaluation

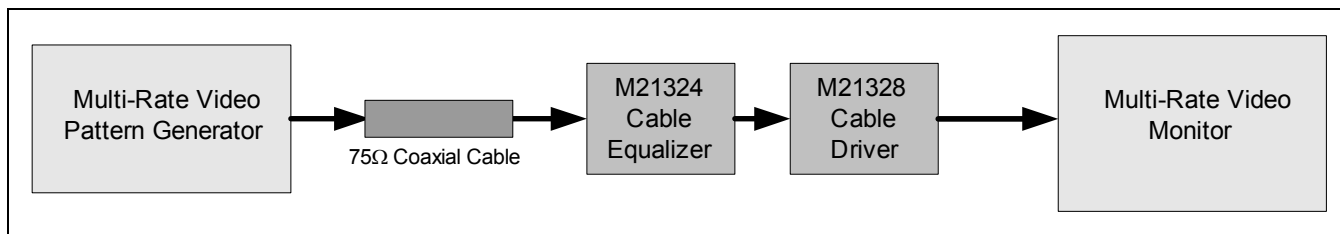

## 2.2 M21324 Common Signals by Interface Group

Table 2-1. Power Pins

Pin Name	Pin Number	Function	Type
AV <sub>SS</sub>	1, 4, 9, 12	Ground	Power
AV <sub>DD</sub>	13, 16	Positive Supply	Power
Center Pad	—	Chip Ground	Power

Table 2-2. High-speed Signal Pins

Pin Name	Pin Number	Function	Type
SDI/ $\overline{\text{SDI}}$	2, 3	Non-inverting and Inverting Serial Data Input to the adaptive equalizer	I— AC coupled high speed
SDO/ $\overline{\text{SDO}}$	11, 10	Non-inverting and Inverting Differential Serial Data Output	O— High speed CML

## 2.2.1 M21324 Pins

**Table 2-3. Control/Interface Pins**

Pin Name	Pin Number	Function	Default	Type
AGC/AGC	5, 6	External AGC (Automatic Gain Control) capacitor connection points. Use 1.0uF capacitor.	Internal pull up	Analog
EQ_BYP	7	Input control signal that when enabled (High) bypasses the inputs directly to the output stage. Low = Normal operation High = Disables EQ and bypasses input to output	Internal pull down	I—CMOS
NC	14	Internal, no connection. Mute not available on this pin	N/A	N/A
THRESH	8	Input control signal voltage. Programmable cable length forced mute threshold. This function is disabled if $\overline{\text{SD/MUTE}}$ = Low	Internal pull down	Analog
$\overline{\text{SD/MUTE}}$	15	Bidirectional Signal that can be used as an input control signal or as an output status indicator. When configured as an input by forcing a voltage on $\overline{\text{SD/MUTE}}$ = High, the SDO outputs will be inhibited at logic low (outputs muted). See <a href="#">Table 1-4</a> for levels. When $\overline{\text{SD/MUTE}}$ = Low (Vss), the output is never muted and the programmable cable length based mute function is disabled. When configured as an output (tied to a high-impedance input) or left floating, the programmable inhibit based on cable length is enabled Configured as Output: Low = Input signal detect High = Loss of signal Configured as Input: Low = Never mute High = Force Mute	—	I/O
<p><b>NOTE:</b> Internal pull-up/pull-down is 100 kΩ. NC: GS2974A, GS1574/GD1574A and GS9074 use this pin as MUTE.</p>				



# Appendix

---

## A.1 Glossary of Terms/Acronyms

BER	Bit Error Rate
CD	Cable Driver
CDA	Cable Distribution Amplifier
CML	Current Mode Logic
DDI	Differential Data Inputs
DTV	Digital Television
DVB	Digital Video Broadcast
EMI	Electro Magnetic Interference
EQ	Equalizer or Equalization
ESD	Electro Static Discharge
GREEN	Environmentally friendly
HD	High Definition
HW	Hardware
ID	Identifier
I/O	Input/Output
MLF	Micro Lead Frame package (also called QFN)
RoHS	Restriction of Hazardous Substances
SD	Standard Definition
SDI	Serial Digital Input
SDO	Serial Digital Output
SE	Single Ended
SMPTE	Society of Motion Picture and Television Engineers
SW	Software

## **A.2 Reference Documents**

### **A.2.1 External**

The following external documents were referenced in this data sheet.

- Application Notes for Surface Mount Assembly of Amkor's MicroLeadFrame (MLF) Packages
- Amkor Technology Thermal Test Report TT-00-06 (See <http://www.amkor.com> for detailed information)
- SMPTE 292M, SMPTE 259M, SMPTE 344M, SMPTE424M
- ESI TR101 891 DVB Asynchronous Serial Interface (ASI)

[www.mindspeed.com](http://www.mindspeed.com)

General Information:  
Telephone: (949) 579-3000  
Headquarters - Newport Beach  
4000 MacArthur Blvd., East Tower  
Newport Beach, CA 92660

© 2007-2009 Mindspeed Technologies®, Inc. All rights reserved.

Information in this document is provided in connection with Mindspeed Technologies® ("Mindspeed®") products. These materials are provided by Mindspeed as a service to its customers and may be used for informational purposes only. Except as provided in Mindspeed's Terms and Conditions of Sale for such products or in any separate agreement related to this document, Mindspeed assumes no liability whatsoever. Mindspeed assumes no responsibility for errors or omissions in these materials. Mindspeed may make changes to specifications and product descriptions at any time, without notice. Mindspeed makes no commitment to update the information and shall have no responsibility whatsoever for conflicts or incompatibilities arising from future changes to its specifications and product descriptions. No license, express or implied, by estoppel or otherwise, to any intellectual property rights is granted by this document.

THESE MATERIALS ARE PROVIDED "AS IS" WITHOUT WARRANTY OF ANY KIND, EITHER EXPRESS OR IMPLIED, RELATING TO SALE AND/OR USE OF MINDSPEED PRODUCTS INCLUDING LIABILITY OR WARRANTIES RELATING TO FITNESS FOR A PARTICULAR PURPOSE, CONSEQUENTIAL OR INCIDENTAL DAMAGES, MERCHANTABILITY, OR INFRINGEMENT OF ANY PATENT, COPYRIGHT OR OTHER INTELLECTUAL PROPERTY RIGHT. MINDSPEED FURTHER DOES NOT WARRANT THE ACCURACY OR COMPLETENESS OF THE INFORMATION, TEXT, GRAPHICS OR OTHER ITEMS CONTAINED WITHIN THESE MATERIALS. MINDSPEED SHALL NOT BE LIABLE FOR ANY SPECIAL, INDIRECT, INCIDENTAL, OR CONSEQUENTIAL DAMAGES, INCLUDING WITHOUT LIMITATION, LOST REVENUES OR LOST PROFITS, WHICH MAY RESULT FROM THE USE OF THESE MATERIALS.

Mindspeed products are not intended for use in medical, lifesaving or life sustaining applications. Mindspeed customers using or selling Mindspeed products for use in such applications do so at their own risk and agree to fully indemnify Mindspeed for any damages resulting from such improper use or sale.