



Chipsmall Limited consists of a professional team with an average of over 10 year of expertise in the distribution of electronic components. Based in Hongkong, we have already established firm and mutual-benefit business relationships with customers from,Europe,America and south Asia,supplying obsolete and hard-to-find components to meet their specific needs.

With the principle of “Quality Parts,Customers Priority,Honest Operation,and Considerate Service”,our business mainly focus on the distribution of electronic components. Line cards we deal with include Microchip,ALPS,ROHM,Xilinx,Pulse,ON,Everlight and Freescale. Main products comprise IC,Modules,Potentiometer,IC Socket,Relay,Connector.Our parts cover such applications as commercial,industrial, and automotives areas.

We are looking forward to setting up business relationship with you and hope to provide you with the best service and solution. Let us make a better world for our industry!



Contact us

Tel: +86-755-8981 8866 Fax: +86-755-8427 6832

Email & Skype: info@chipsmall.com Web: www.chipsmall.com

Address: A1208, Overseas Decoration Building, #122 Zhenhua RD., Futian, Shenzhen, China



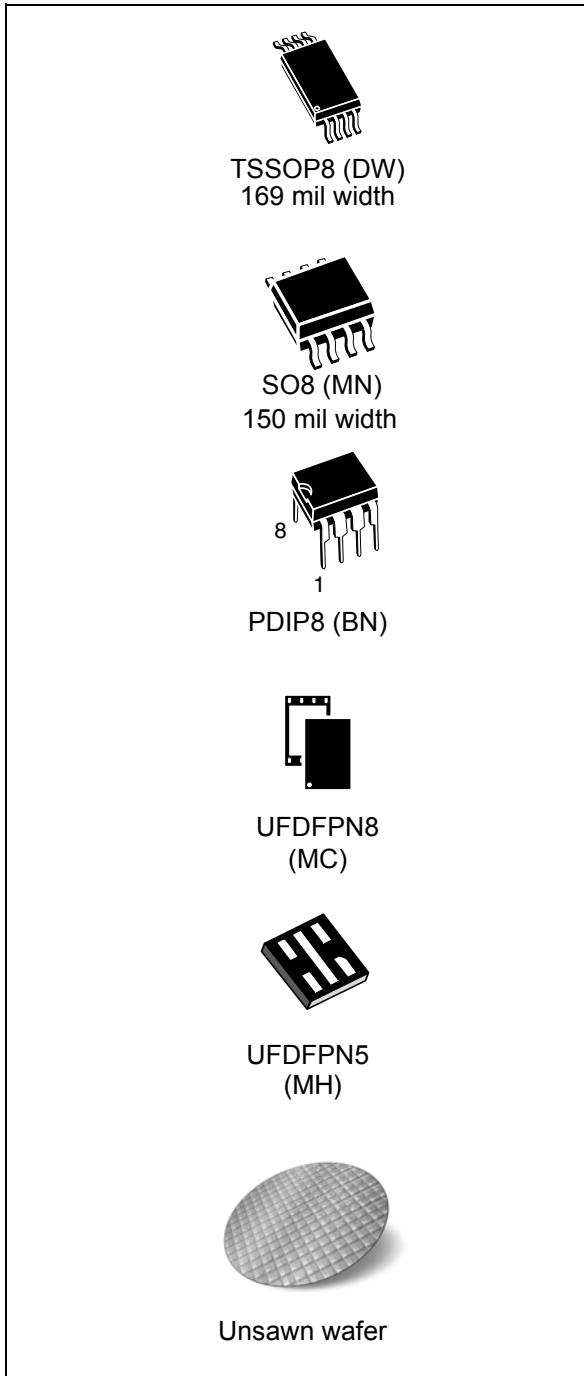

Features

- Compatible with all I²C bus modes:
 - 400 kHz
 - 100 kHz
- Memory array:
 - 16 Kbit (2 Kbyte) of EEPROM
 - Page size: 16 byte
- Single supply voltage:
 - M24C16-W: 2.5 V to 5.5 V
 - M24C16-R: 1.8 V to 5.5 V
 - M24C16-F: 1.7 V to 5.5 V (full temperature range) and 1.6 V to 1.7 V (limited temperature range)
- Write:
 - Byte Write within 5 ms
 - Page Write within 5 ms
- Operating temperature range:
 - from -40 °C up to +85 °C
- Random and sequential Read modes
- Write protect of the whole memory array
- Enhanced ESD/Latch-Up protection
- More than 4 million Write cycles
- More than 200-years data retention

Packages

- PDIP8 ECOPACK1[®]
- SO8 ECOPACK2[®]
- TSSOP8 ECOPACK2[®]
- UFDFPN8 ECOPACK2[®]
- UFDFPN5 ECOPACK2[®]
- Unsawn wafer (each die is tested)

Contents

1	Description	6
2	Signal description	8
2.1	Serial Clock (SCL)	8
2.2	Serial Data (SDA)	8
2.3	Write Control (\overline{WC})	8
2.4	V _{SS} (ground)	8
2.5	Supply voltage (V _{CC})	8
2.5.1	Operating supply voltage (V _{CC})	8
2.5.2	Power-up conditions	8
2.5.3	Device reset	9
2.5.4	Power-down conditions	9
3	Memory organization	10
4	Device operation	11
4.1	Start condition	12
4.2	Stop condition	12
4.3	Data input	12
4.4	Acknowledge bit (ACK)	12
4.5	Device addressing	13
5	Instructions	14
5.1	Write operations	14
5.1.1	Byte Write	15
5.1.2	Page Write	16
5.1.3	Minimizing Write delays by polling on ACK	17
5.2	Read operations	18
5.2.1	Random Address Read	19
5.2.2	Current Address Read	19
5.2.3	Sequential Read	19
6	Initial delivery state	20

7	Maximum rating	21
8	DC and AC parameters	22
9	Package mechanical data	30
9.1	UFDFPN5 package information	31
9.2	UFDFPN8 package information	32
9.3	TSSOP8 package information	33
9.4	SO8N package information	34
9.5	PDIP8 package information	36
10	Part numbering	37
11	Revision history	40

List of tables

Table 1.	Signal names	6
Table 2.	Device select code	13
Table 3.	Address byte	14
Table 4.	Absolute maximum ratings	21
Table 5.	Operating conditions (voltage range W)	22
Table 6.	Operating conditions (voltage range R)	22
Table 7.	Operating conditions (voltage range F, for devices identified by process letter T)	22
Table 8.	Operating conditions (voltage range F, for all other devices)	22
Table 9.	AC measurement conditions	22
Table 10.	Input parameters	23
Table 11.	Cycling performance	23
Table 12.	Memory cell data retention	23
Table 13.	DC characteristics (M24C16-W, device grade 6)	24
Table 14.	DC characteristics (M24C16-R device grade 6)	25
Table 15.	DC characteristics (M24C16-F device grade 6)	26
Table 16.	400 kHz AC characteristics	27
Table 17.	100 kHz AC characteristics (I ² C Standard mode)	28
Table 18.	UFDFPN5 - 1.7 × 1.4 mm, 0.55 mm thickness, ultra thin fine pitch dual flat package, no lead - package mechanical data	31
Table 19.	UFDFPN8 – 2x3 mm, 0.55 thickness, ultra thin fine pitch dual flat package, no lead - package mechanical data	32
Table 20.	TSSOP8 – 3 x 4.4 mm, 0.65 mm pitch, 8-lead thin shrink small outline, package mechanical data	33
Table 21.	SO8N – 3.9x4.9 mm, 8-lead plastic small outline, 150 mils body width, package mechanical data	34
Table 22.	PDIP8 – 8-pin plastic DIP, 0.25 mm lead frame, package mechanical data	36
Table 23.	Ordering information scheme	37
Table 24.	Ordering information scheme (unsawn wafer)	38
Table 25.	Document revision history	40

List of figures

Figure 1.	Logic diagram	6
Figure 2.	8-pin package connections, top view	6
Figure 3.	UFDFPN5 package connections	7
Figure 4.	Block diagram	10
Figure 5.	I ² C bus protocol	11
Figure 6.	Write mode sequences with $\overline{WC} = 0$ (data write enabled)	15
Figure 7.	Write mode sequences with $\overline{WC} = 1$ (data write inhibited)	16
Figure 8.	Write cycle polling flowchart using ACK	17
Figure 9.	Read mode sequences	18
Figure 10.	AC measurement I/O waveform	23
Figure 11.	Maximum Rbus value versus bus parasitic capacitance (Cbus) for an I2C bus at maximum frequency fC = 400 kHz.	29
Figure 12.	AC waveforms	29
Figure 13.	UFDFPN5 – 1.7x1.4 mm, 0.55 mm thickness, ultra thin fine pitch dual flat package, no lead - package outline	31
Figure 14.	UFDFPN8 – 2x3 mm, 0.55 mm thickness, ultra thin fine pitch dual flat package, no leadpackage outline	32
Figure 15.	TSSOP8 – 3x4.4 mm, 0.65 mm pitch, 8-lead thin shrink small outline, package outline.	33
Figure 16.	SO8N – 3.9x4.9 mm, 8-lead plastic small outline, 150 mils body width, package outline	34
Figure 17.	SO8N – 3.9x4.9 mm, 8-lead plastic small outline, 150 mils body width, package recommended footprint	35
Figure 18.	PDIP8 – 8-pin plastic DIP, 0.25 mm lead frame, package outline	36

1 Description

The M24C16 is a 16-Kbit I²C-compatible EEPROM (Electrically Erasable PROgrammable Memory) organized as 2 K × 8 bits.

The M24C16-W can be accessed (Read and Write) with a supply voltage from 2.5 V to 5.5 V, the M24C16-R can be accessed (Read and Write) with a supply voltage from 1.8 V to 5.5 V, and the M24C16-F can be accessed either with a supply voltage from 1.7 V to 5.5 V (over the full temperature range) or with an extended supply voltage from 1.6 V to 1.7 V. All these devices operate with a clock frequency of 400 kHz.

Figure 1. Logic diagram

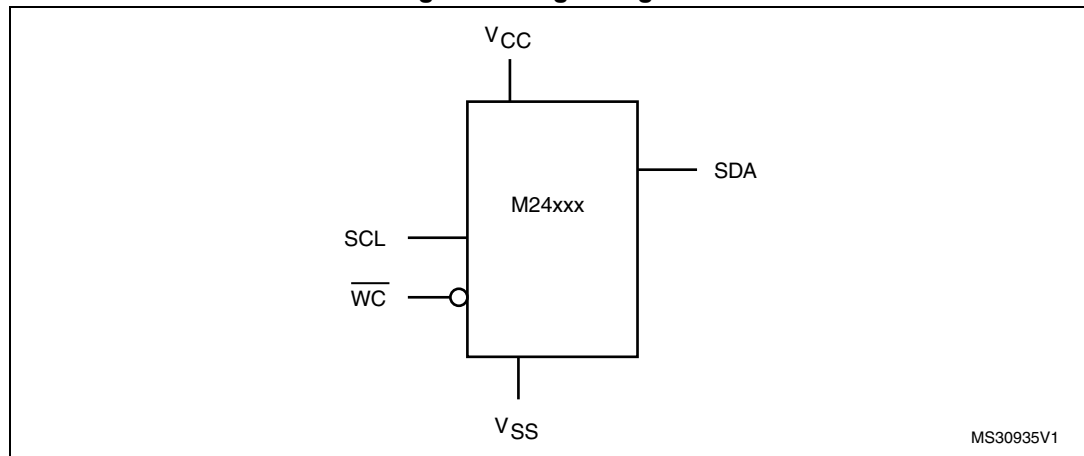
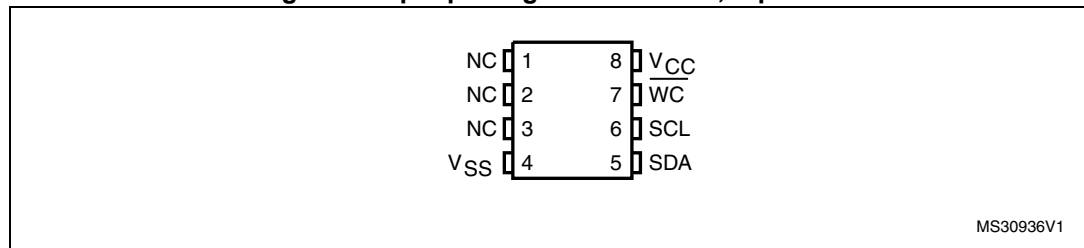

Table 1. Signal names

Signal name	Function	Direction
SDA	Serial Data	I/O
SCL	Serial Clock	Input
\overline{WC}	Write Control	Input
V _{CC}	Supply voltage	-
V _{SS}	Ground	-

Figure 2. 8-pin package connections, top view



1. NC: Not Connected

Figure 3. UDFPN5 package connections

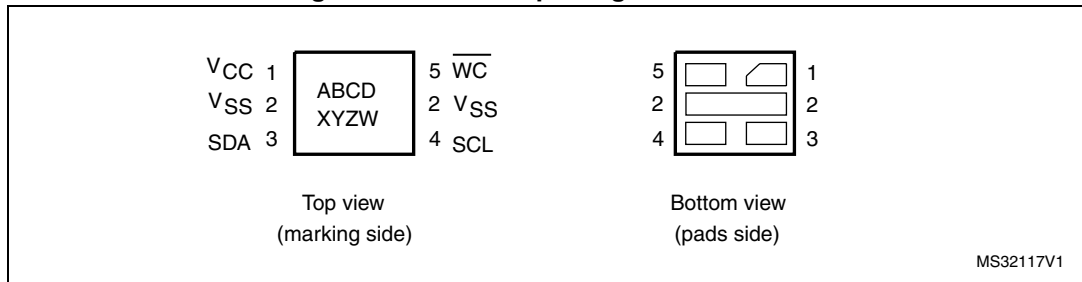

1. See [Section 9: Package mechanical data](#) for package dimensions, and how to identify pin 1

2 Signal description

2.1 Serial Clock (SCL)

The signal applied on the SCL input is used to strobe the data available on SDA(in) and to output the data on SDA(out).

2.2 Serial Data (SDA)

SDA is an input/output used to transfer data in or data out of the device. SDA(out) is an open drain output that may be wire-OR'ed with other open drain or open collector signals on the bus. A pull-up resistor must be connected from Serial Data (SDA) to V_{CC} ([Figure 11](#) indicates how to calculate the value of the pull-up resistor).

2.3 Write Control (\overline{WC})

This input signal is useful for protecting the entire contents of the memory from inadvertent write operations. Write operations are disabled to the entire memory array when Write Control (\overline{WC}) is driven high. Write operations are enabled when Write Control (\overline{WC}) is either driven low or left floating.

When Write Control (\overline{WC}) is driven high, device select and address bytes are acknowledged, Data bytes are not acknowledged.

2.4 V_{SS} (ground)

V_{SS} is the reference for the V_{CC} supply voltage.

2.5 Supply voltage (V_{CC})

2.5.1 Operating supply voltage (V_{CC})

Prior to selecting the memory and issuing instructions to it, a valid and stable V_{CC} voltage within the specified [$V_{CC}(\min)$, $V_{CC}(\max)$] range must be applied (see Operating conditions in [Section 8: DC and AC parameters](#)). In order to secure a stable DC supply voltage, it is recommended to decouple the V_{CC} line with a suitable capacitor (usually of the order of 10 nF to 100 nF) close to the V_{CC}/V_{SS} package pins.

This voltage must remain stable and valid until the end of the transmission of the instruction and, for a write instruction, until the completion of the internal write cycle (t_W).

2.5.2 Power-up conditions

The V_{CC} voltage has to rise continuously from 0 V up to the minimum V_{CC} operating voltage (see Operating conditions in [Section 8: DC and AC parameters](#)).

2.5.3 Device reset

In order to prevent inadvertent write operations during power-up, a power-on-reset (POR) circuit is included.

At power-up, the device does not respond to any instruction until V_{CC} has reached the internal reset threshold voltage. This threshold is lower than the minimum V_{CC} operating voltage (see Operating conditions in [Section 8: DC and AC parameters](#)). When V_{CC} passes over the POR threshold, the device is reset and enters the Standby Power mode; however, the device must not be accessed until V_{CC} reaches a valid and stable DC voltage within the specified [$V_{CC}(\text{min})$, $V_{CC}(\text{max})$] range (see Operating conditions in [Section 8: DC and AC parameters](#)).

In a similar way, during power-down (continuous decrease in V_{CC}), the device must not be accessed when V_{CC} drops below $V_{CC}(\text{min})$. When V_{CC} drops below the threshold voltage, the device stops responding to any instruction sent to it.

2.5.4 Power-down conditions

During power-down (continuous decrease in V_{CC}), the device must be in the Standby Power mode (mode reached after decoding a Stop condition, assuming that there is no internal write cycle in progress).

3 Memory organization

The memory is organized as shown below.

Figure 4. Block diagram

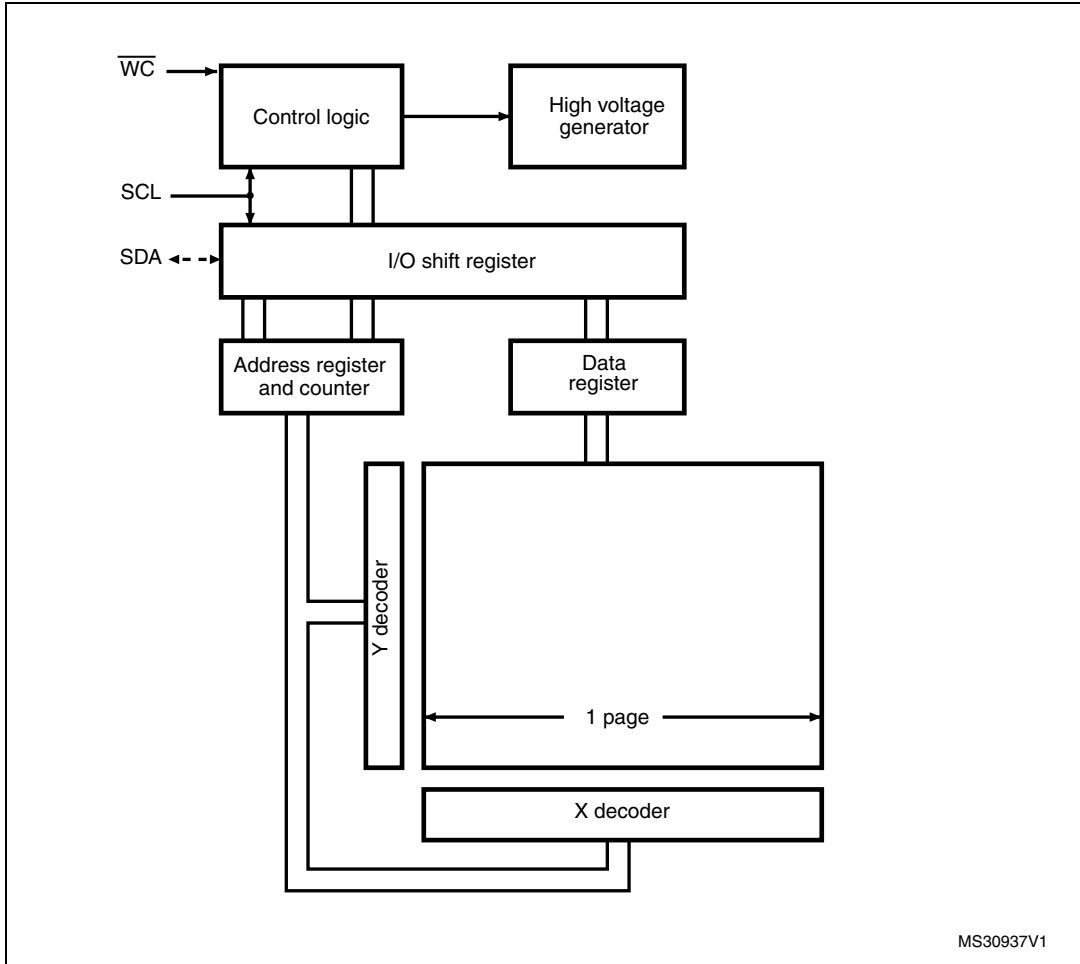

4 Device operation

The device supports the I²C protocol. This is summarized in [Figure 5](#). Any device that sends data on to the bus is defined to be a transmitter, and any device that reads the data to be a receiver. The device that controls the data transfer is known as the bus master, and the other as the slave device. A data transfer can only be initiated by the bus master, which will also provide the serial clock for synchronization. The device is always a slave in all communications.

Figure 5. I²C bus protocol

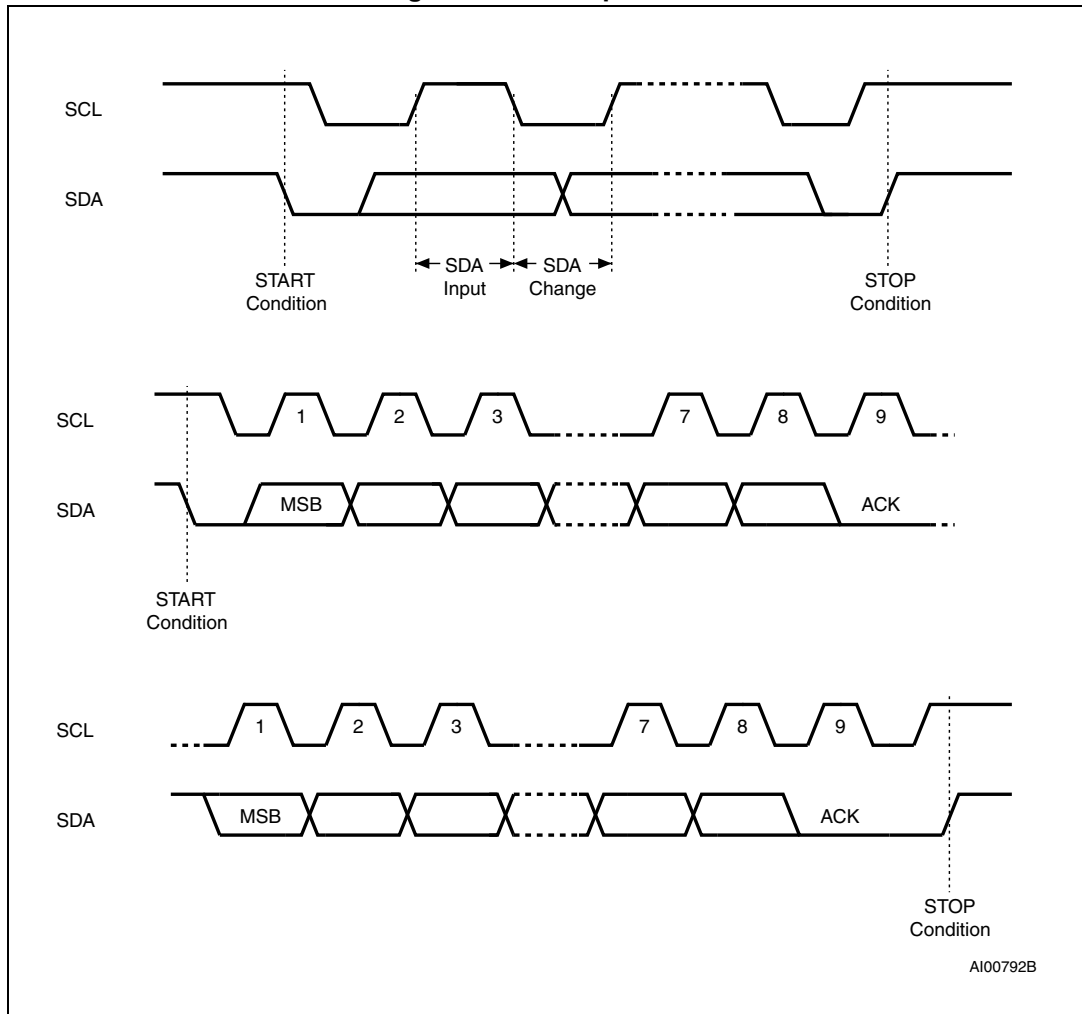

4.1 Start condition

Start is identified by a falling edge of Serial Data (SDA) while Serial Clock (SCL) is stable in the high state. A Start condition must precede any data transfer instruction. The device continuously monitors (except during a Write cycle) Serial Data (SDA) and Serial Clock (SCL) for a Start condition.

4.2 Stop condition

Stop is identified by a rising edge of Serial Data (SDA) while Serial Clock (SCL) is stable and driven high. A Stop condition terminates communication between the device and the bus master. A Read instruction that is followed by NoAck can be followed by a Stop condition to force the device into the Standby mode.

A Stop condition at the end of a Write instruction triggers the internal Write cycle.

4.3 Data input

During data input, the device samples Serial Data (SDA) on the rising edge of Serial Clock (SCL). For correct device operation, Serial Data (SDA) must be stable during the rising edge of Serial Clock (SCL), and the Serial Data (SDA) signal must change *only* when Serial Clock (SCL) is driven low.

4.4 Acknowledge bit (ACK)

The acknowledge bit is used to indicate a successful byte transfer. The bus transmitter, whether it be bus master or slave device, releases Serial Data (SDA) after sending eight bits of data. During the 9th clock pulse period, the receiver pulls Serial Data (SDA) low to acknowledge the receipt of the eight data bits.

4.5 Device addressing

To start communication between the bus master and the slave device, the bus master must initiate a Start condition. Following this, the bus master sends the device select code, shown in [Table 2](#) (most significant bit first).

Table 2. Device select code

Device type identifier ⁽¹⁾				Chip Enable address			\overline{RW}
b7	b6	b5	b4	b3	b2	b1	b0
1	0	1	0	A10	A9	A8	\overline{RW}

1. The most significant bit, b7, is sent first.

The 8th bit is the Read/Write bit (\overline{RW}). This bit is set to 1 for Read and 0 for Write operations.

If a match occurs on the device select code, the corresponding device gives an acknowledgment on Serial Data (SDA) during the 9th bit time. If the device does not match the device select code, it deselects itself from the bus, and goes into Standby mode.

5 Instructions

5.1 Write operations

Following a Start condition the bus master sends a device select code with the $\overline{R/W}$ bit (\overline{RW}) reset to 0. The device acknowledges this, as shown in [Figure 6](#), and waits for the address byte. The device responds to each address byte with an acknowledge bit, and then waits for the data byte.

Table 3. Address byte

A7	A6	A5	A4	A3	A2	A1	A0
----	----	----	----	----	----	----	----

When the bus master generates a Stop condition immediately after a data byte Ack bit (in the “10th bit” time slot), either at the end of a Byte Write or a Page Write, the internal Write cycle t_W is triggered. A Stop condition at any other time slot does not trigger the internal Write cycle.

After the Stop condition and the successful completion of an internal Write cycle (t_W), the device internal address counter is automatically incremented to point to the next byte after the last modified byte.

During the internal Write cycle, Serial Data (SDA) is disabled internally, and the device does not respond to any requests.

If the Write Control input (WC) is driven High, the Write instruction is not executed and the accompanying data bytes are *not* acknowledged, as shown in [Figure 7](#).

5.1.1 Byte Write

After the device select code and the address byte, the bus master sends one data byte. If the addressed location is Write-protected, by Write Control (\overline{WC}) being driven high, the device replies with NoAck, and the location is not modified. If, instead, the addressed location is not Write-protected, the device replies with Ack. The bus master terminates the transfer by generating a Stop condition, as shown in *Figure 6*.

Figure 6. Write mode sequences with $\overline{WC} = 0$ (data write enabled)

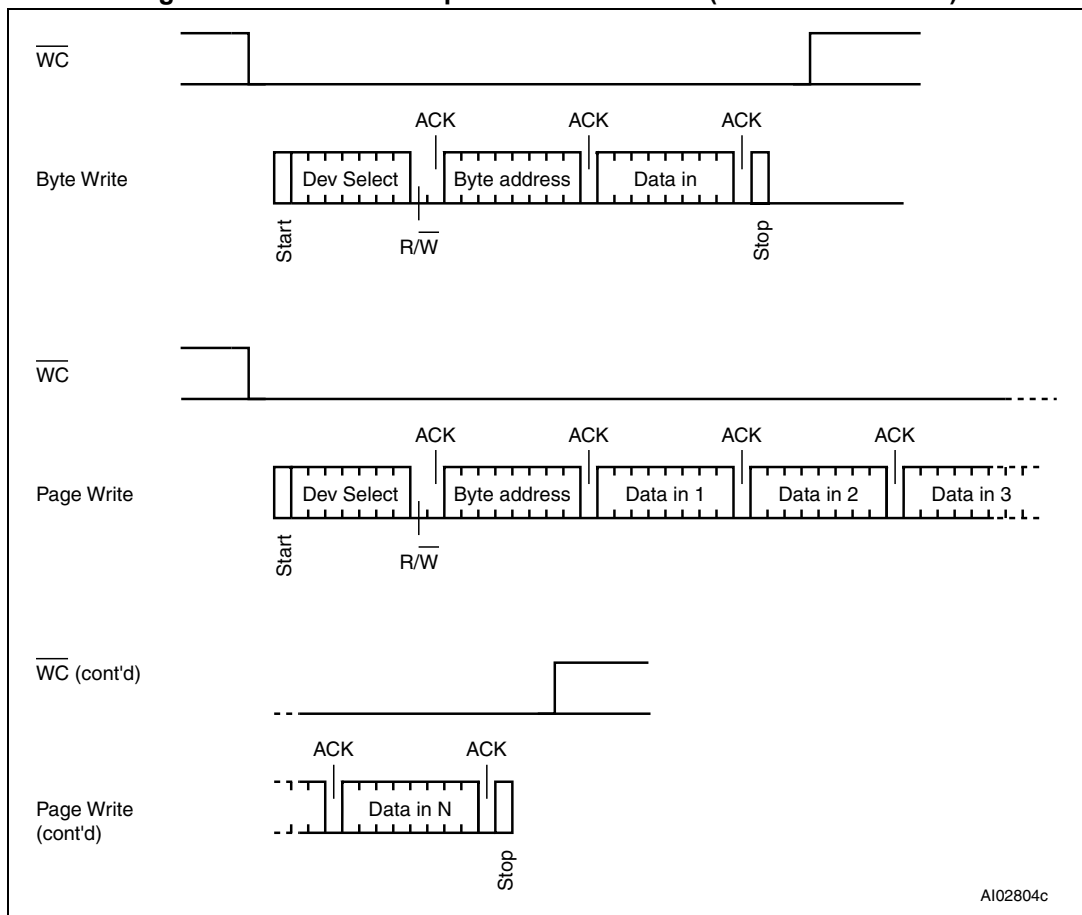

5.1.2 Page Write

The Page Write mode allows up to 16 byte to be written in a single Write cycle, provided that they are all located in the same page in the memory: that is, the most significant memory address bits, A10/A4, are the same. If more bytes are sent than will fit up to the end of the page, a “roll-over” occurs, i.e. the bytes exceeding the page end are written on the same page, from location 0.

The bus master sends from 1 to 16 byte of data, each of which is acknowledged by the device if Write Control (\overline{WC}) is low. If Write Control (\overline{WC}) is high, the contents of the addressed memory location are not modified, and each data byte is followed by a NoAck, as shown in *Figure 7*. After each transferred byte, the internal page address counter is incremented.

The transfer is terminated by the bus master generating a Stop condition.

Figure 7. Write mode sequences with $\overline{WC} = 1$ (data write inhibited)

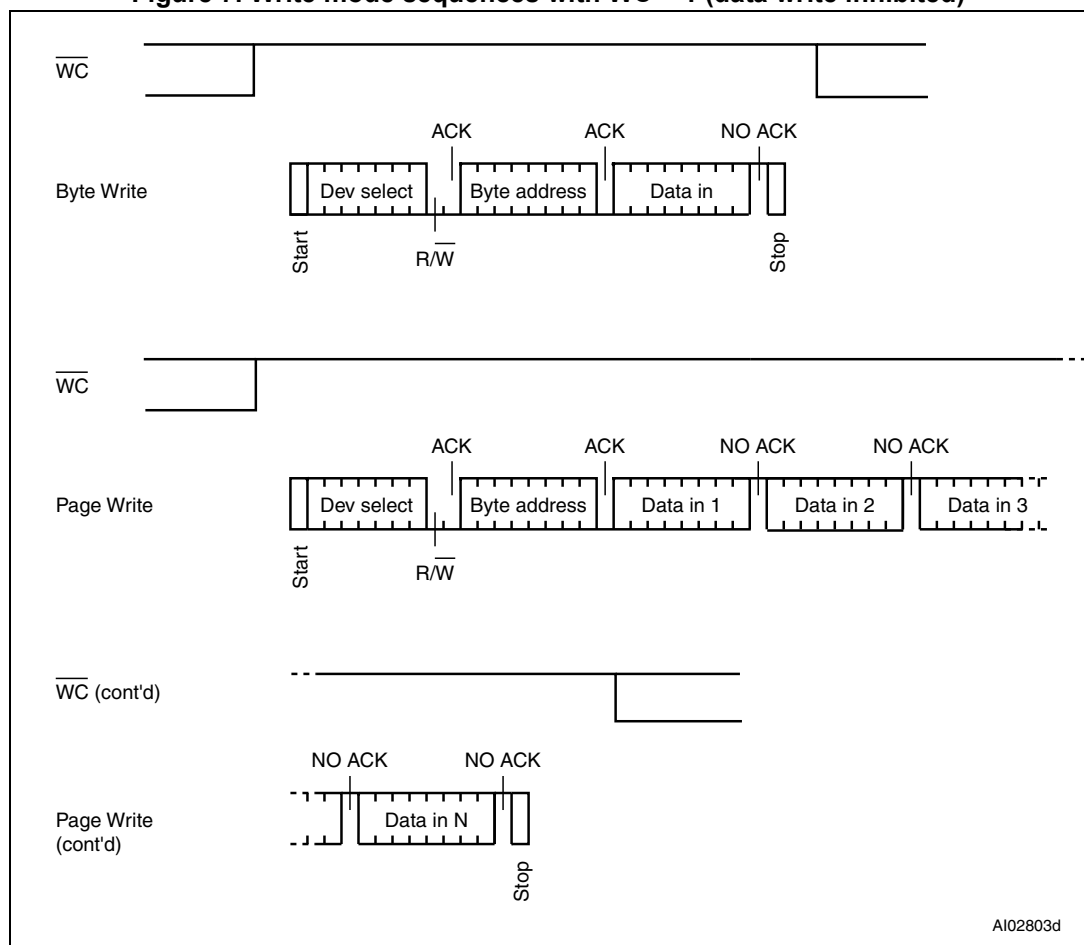

5.1.3 Minimizing Write delays by polling on ACK

The maximum Write time (t_w) is shown in AC characteristics tables in [Section 8: DC and AC parameters](#), but the typical time is shorter. To make use of this, a polling sequence can be used by the bus master.

The sequence, as shown in [Figure 8](#), is:

- Initial condition: a Write cycle is in progress.
- Step 1: the bus master issues a Start condition followed by a device select code (the first byte of the new instruction).
- Step 2: if the device is busy with the internal Write cycle, no Ack will be returned and the bus master goes back to Step 1. If the device has terminated the internal Write cycle, it responds with an Ack, indicating that the device is ready to receive the second part of the instruction (the first byte of this instruction having been sent during Step 1).

Figure 8. Write cycle polling flowchart using ACK

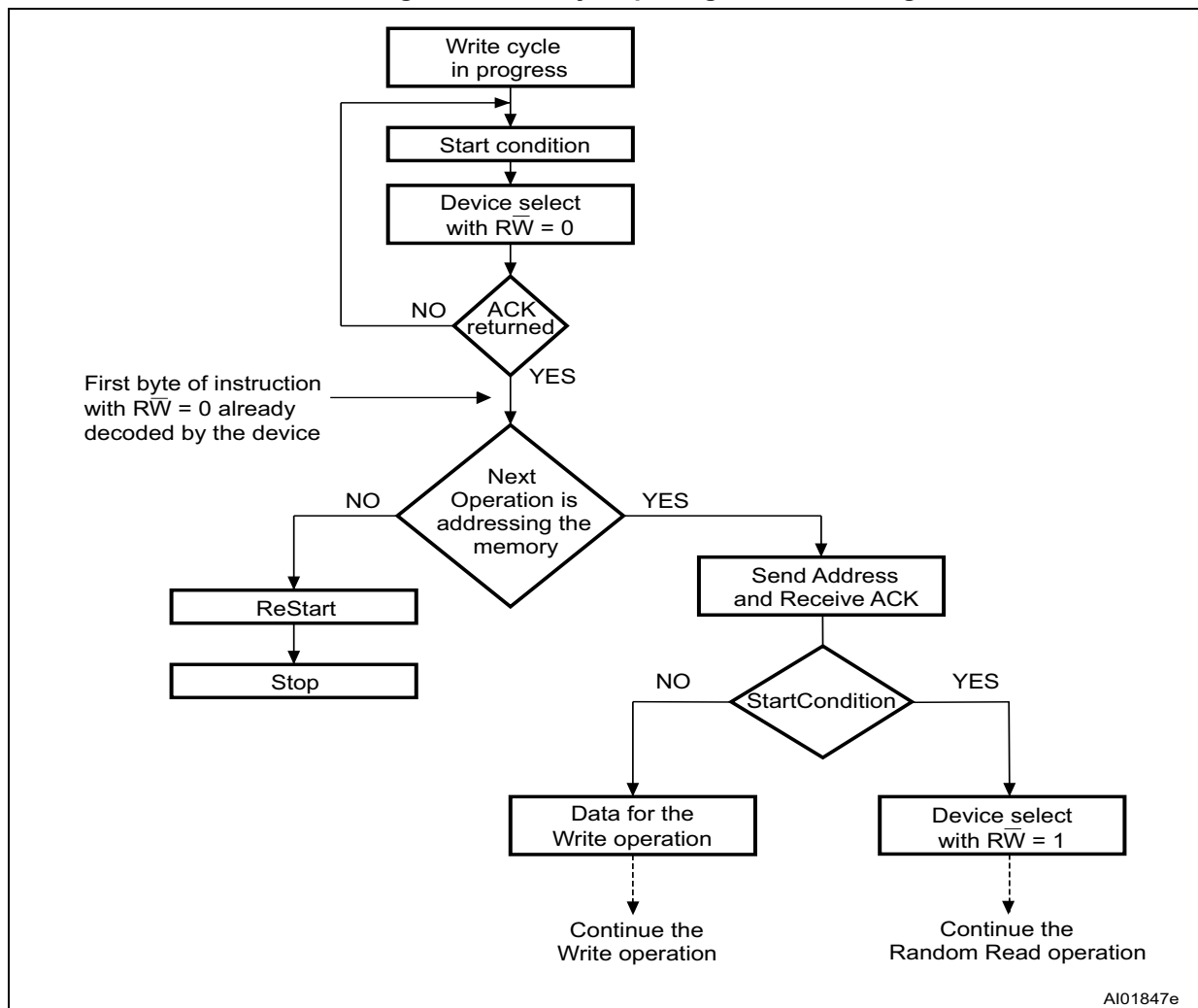

5.2 Read operations

Read operations are performed independently of the state of the Write Control (\overline{WC}) signal. After the successful completion of a Read operation, the device internal address counter is incremented by one, to point to the next byte address.

For the Read instructions, after each byte read (data out), the device waits for an acknowledgment (data in) during the 9th bit time. If the bus master does not acknowledge during this 9th time, the device terminates the data transfer and switches to its Standby mode.

Figure 9. Read mode sequences

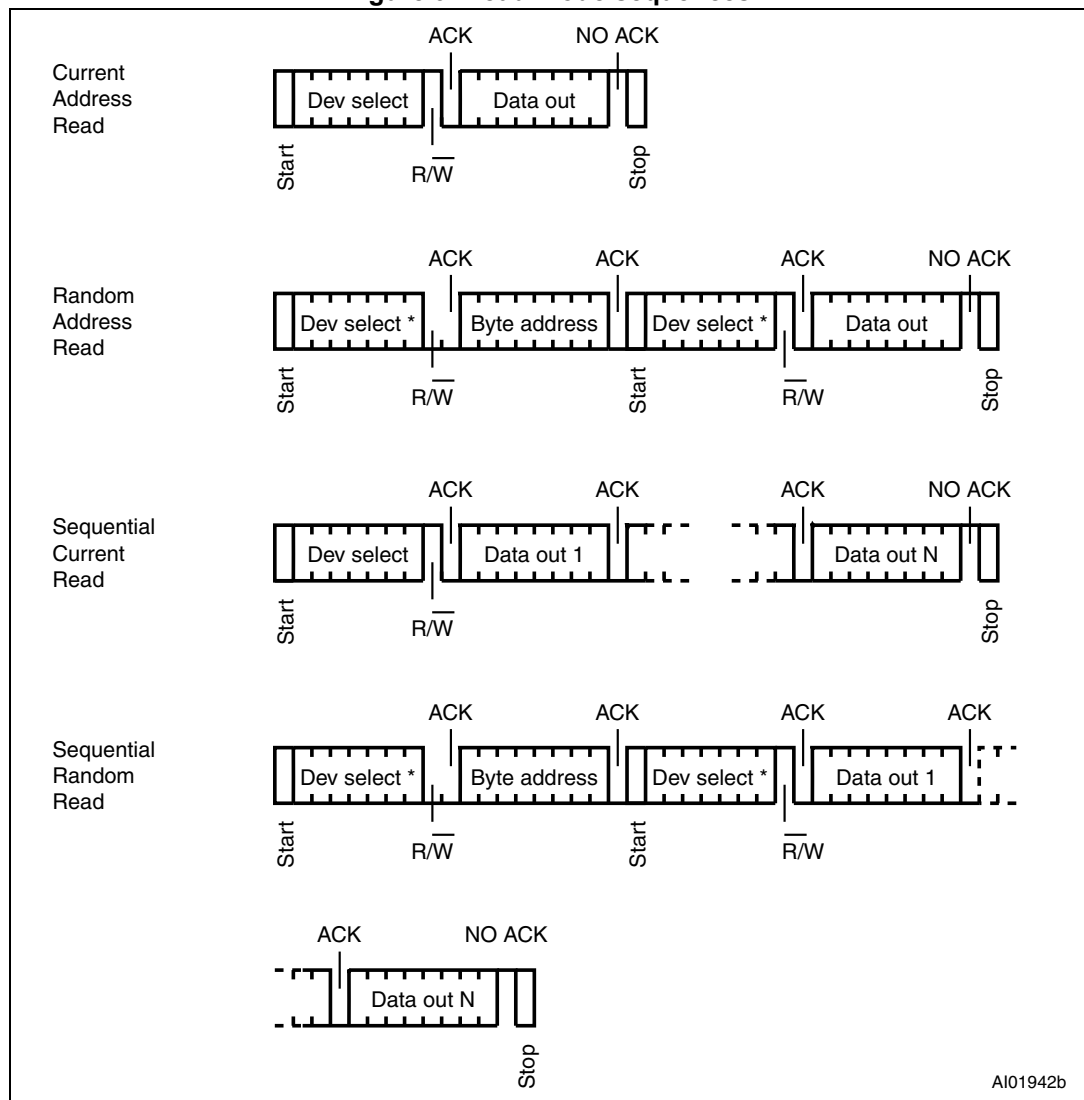

5.2.1 Random Address Read

A dummy Write is first performed to load the address into this address counter (as shown in [Figure 9](#)) but *without* sending a Stop condition. Then, the bus master sends another Start condition, and repeats the device select code, with the \overline{RW} bit set to 1. The device acknowledges this, and outputs the contents of the addressed byte. The bus master must *not* acknowledge the byte, and terminates the transfer with a Stop condition.

5.2.2 Current Address Read

For the Current Address Read operation, following a Start condition, the bus master only sends a device select code with the \overline{RW} bit set to 1. The device acknowledges this, and outputs the byte addressed by the internal address counter. The counter is then incremented. The bus master terminates the transfer with a Stop condition, as shown in [Figure 9](#), *without* acknowledging the byte.

5.2.3 Sequential Read

This operation can be used after a Current Address Read or a Random Address Read. The bus master *does* acknowledge the data byte output, and sends additional clock pulses so that the device continues to output the next byte in sequence. To terminate the stream of bytes, the bus master must *not* acknowledge the last byte, and *must* generate a Stop condition, as shown in [Figure 9](#).

The output data comes from consecutive addresses, with the internal address counter automatically incremented after each byte output. After the last memory address, the address counter “rolls-over”, and the device continues to output data from memory address 00h.

6 Initial delivery state

The device is delivered with all the memory array bits set to 1 (each byte contains FFh).

When delivered in unsawn wafer, all memory bits are set to 1 (each memory byte contains FFh) except the last byte located at address FFFh which is written with the value 22h.

7 Maximum rating

Stressing the device outside the ratings listed in [Table 4](#) may cause permanent damage to the device. These are stress ratings only, and operation of the device at these, or any other conditions outside those indicated in the operating sections of this specification, is not implied. Exposure to absolute maximum rating conditions for extended periods may affect device reliability.

Table 4. Absolute maximum ratings

Symbol	Parameter	Min.	Max.	Unit
	Ambient operating temperature	-40	130	°C
T _{STG}	Storage temperature	-65	150	°C
T _{LEAD}	Lead temperature during soldering	see note ⁽¹⁾		°C
	PDIP-specific lead temperature during soldering	-	260 ⁽²⁾	°C
I _{OL}	DC output current (SDA = 0)	-	5	mA
V _{IO}	Input or output range	-0.50	6.5	V
V _{CC}	Supply voltage	-0.50	6.5	V
V _{ESD}	Electrostatic pulse (Human Body model) ⁽³⁾	-	3000 ⁽⁴⁾	V

1. Compliant with JEDEC Std J-STD-020D (for small body, Sn-Pb or Pb-free assembly), the ST ECOPACK® 7191395 specification, and the European directive on Restrictions of Hazardous Substances (RoHS directive 2011/65/EU of July 2011).
2. T_{LEAD} max must not be applied for more than 10 s.
3. Positive and negative pulses applied on different combinations of pin connections, according to AEC-Q100-002 (compliant with ANSI/ESDA/JEDEC JS-001-2012 standard, C1=100 pF, R1=1500 Ω).
4. 4000 V for devices identified by process letters S or G.

8 DC and AC parameters

This section summarizes the operating and measurement conditions, and the DC and AC characteristics of the device.

Table 5. Operating conditions (voltage range W)

Symbol	Parameter	Min.	Max.	Unit
V_{CC}	Supply voltage	2.5	5.5	V
T_A	Ambient operating temperature	-40	85	°C
f_C	Operating clock frequency	-	400	kHz

Table 6. Operating conditions (voltage range R)

Symbol	Parameter	Min.	Max.	Unit
V_{CC}	Supply voltage	1.8	5.5	V
T_A	Ambient operating temperature	-40	85	°C
f_C	Operating clock frequency	-	400	kHz

Table 7. Operating conditions (voltage range F, for devices identified by process letter T)

Symbol	Parameter	Min.			Max.	Unit
V_{CC}	Supply voltage	1.60	1.65	1.70	5.5	V
T_A	Ambient operating temperature: READ	-40	-40	-40	85	°C
	Ambient operating temperature: WRITE	0	-20	-40	85	
f_C	Operating clock frequency	-	-	-	400	kHz

Table 8. Operating conditions (voltage range F, for all other devices)

Symbol	Parameter	Min.	Max.	Unit
V_{CC}	Supply voltage	1.7	5.5	V
T_A	Ambient operating temperature	-20	85	°C
f_C	Operating clock frequency	-	400	kHz

Table 9. AC measurement conditions

Symbol	Parameter	Min.	Max.	Unit
C_{bus}	Load capacitance	100		pF
-	SCL input rise/fall time, SDA input fall time	-	50	ns
-	Input levels	0.2 V_{CC} to 0.8 V_{CC}		V
-	Input and output timing reference levels	0.3 V_{CC} to 0.7 V_{CC}		V

Figure 10. AC measurement I/O waveform

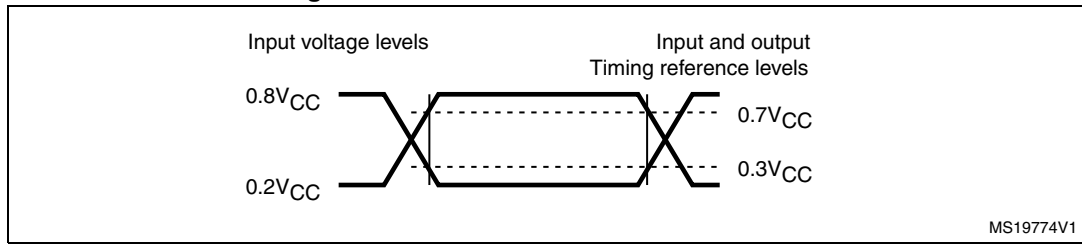

Table 10. Input parameters

Symbol	Parameter ⁽¹⁾	Test condition	Min.	Max.	Unit
C_{IN}	Input capacitance (SDA)	-	-	8	pF
C_{IN}	Input capacitance (other pins)	-	-	6	pF
Z_L	Input impedance (\overline{WC})	$V_{IN} < 0.3 V_{CC}$	30	-	k Ω
Z_H		$V_{IN} > 0.7 V_{CC}$	500	-	k Ω

1. Characterized only, not tested in production.

Table 11. Cycling performance

Symbol	Parameter	Test condition	Max. ⁽¹⁾	Unit
Ncycle	Write cycle endurance	$T_A \leq 25\text{ }^\circ\text{C}, V_{CC}(\text{min}) < V_{CC} < V_{CC}(\text{max})$	4,000,000	Write cycle
		$T_A = 85\text{ }^\circ\text{C}, V_{CC}(\text{min}) < V_{CC} < V_{CC}(\text{max})$	1,200,000	

1. Cycling performance for products identified by process letter T (previous products were specified with 1 million cycles at 25 °C)

Table 12. Memory cell data retention

Parameter	Test condition	Min.	Unit
Data retention ⁽¹⁾	$T_A = 55\text{ }^\circ\text{C}$	200 ⁽²⁾	Year

1. The data retention behavior is checked in production, while the data retention limit defined in this table is extracted from characterization and qualification results.

2. For products identified by process letter T (previous products were specified with a data retention of 40 years at 55°C).

Table 13. DC characteristics (M24C16-W, device grade 6)

Symbol	Parameter	Test conditions (in addition to those in Table 5 and Table 9)	Min.	Max.	Unit
I_{LI}	Input leakage current (SCL, SDA)	$V_{IN} = V_{SS}$ or V_{CC} , device in Standby mode	-	± 2	μA
I_{LO}	Output leakage current	SDA in Hi-Z, external voltage applied on SDA: V_{SS} or V_{CC}	-	± 2	μA
I_{CC}	Supply current (Read)	$V_{CC} = 5.5 V$, $f_c = 400 kHz$	-	1	mA
		$V_{CC} = 2.5 V$, $f_c = 400 kHz$	-	1	mA
I_{CC0}	Supply current (Write)	Value averaged over t_W , $2.5 V \leq V_{CC} \leq 5.5 V$	-	1 ⁽¹⁾	mA
I_{CC1}	Standby supply current	Device not selected ⁽²⁾ , $V_{IN} = V_{SS}$ or V_{CC} , $V_{CC} = 2.5 V$	-	2 ⁽³⁾	μA
		Device not selected ⁽²⁾ , $V_{IN} = V_{SS}$ or V_{CC} , $V_{CC} = 5.5 V$	-	3 ⁽³⁾	μA
V_{IL}	Input low voltage (SCL, SDA, \overline{WC})	-	-0.45	$0.3 V_{CC}$	V
V_{IH}	Input high voltage (SCL, SDA, \overline{WC})	-	$0.7 V_{CC}$	$V_{CC} + 1$	V
V_{OL}	Output low voltage	$I_{OL} = 2.1 mA$, $V_{CC} = 2.5 V$ or $I_{OL} = 3 mA$, $V_{CC} = 5.5 V$	-	0.4	V

1. Characterized only (not tested in production) for devices identified by process letter T. $I_{CC0(max)}$ is lower than 0.5 mA when writing data with an ambient temperature greater than 25 °C.
2. The device is not selected after power-up, after a Read instruction (after the Stop condition), or after the completion of the internal write cycle t_W (t_W is triggered by the correct decoding of a Write instruction).
3. 1 μA for previous devices identified by process letters G or S.

Table 14. DC characteristics (M24C16-R device grade 6)

Symbol	Parameter	Test conditions ⁽¹⁾ (in addition to those in Table 6 and Table 9)	Min.	Max.	Unit
I_{LI}	Input leakage current (SCL, SDA)	$V_{IN} = V_{SS}$ or V_{CC} , device in Standby mode	-	± 2	μA
I_{LO}	Output leakage current	SDA in Hi-Z, external voltage applied on SDA: V_{SS} or V_{CC}	-	± 2	μA
I_{CC}	Supply current (Read)	$V_{CC} = 1.8 V$, $f_c = 400 kHz$	-	0.8	mA
I_{CC0}	Supply current (Write)	Value averaged over t_{W-L} $V_{CC} \leq 2.5 V$	-	1 ⁽²⁾	mA
I_{CC1}	Standby supply current	Device not selected ⁽³⁾ , $V_{IN} = V_{SS}$ or V_{CC} , $V_{CC} = 1.8 V$	-	1	μA
V_{IL}	Input low voltage (SCL, SDA, WC)	$2.5 V \leq V_{CC}$	-0.45	$0.3 V_{CC}$	V
		$V_{CC} < 2.5 V$	-0.45	$0.25 V_{CC}$	V
V_{IH}	Input high voltage (SCL, SDA)	$V_{CC} < 2.5 V$	$0.75 V_{CC}$	6.5	V
		$V_{CC} < 2.5 V$	$0.75 V_{CC}$	$V_{CC} + 0.6$	V
V_{OL}	Output low voltage	$I_{OL} = 0.7 mA$, $V_{CC} = 1.8 V$	-	0.2	V

1. If the application uses the voltage range R device with $2.5 V \leq V_{CC} \leq 5.5 V$ and $-40^\circ C < T_A < +85^\circ C$, please refer to [Table 13](#) instead of this table.
2. Characterized only (not tested in production) for devices identified by process letter T. $I_{CC0(max)}$ is lower than 0.5 mA when writing data with an ambient temperature greater than $25^\circ C$.
3. The device is not selected after power-up, after a Read instruction (after the Stop condition), or after the completion of the internal write cycle t_W (t_W is triggered by the correct decoding of a Write instruction).