



Chipsmall Limited consists of a professional team with an average of over 10 year of expertise in the distribution of electronic components. Based in Hongkong, we have already established firm and mutual-benefit business relationships with customers from,Europe,America and south Asia,supplying obsolete and hard-to-find components to meet their specific needs.

With the principle of “Quality Parts,Customers Priority,Honest Operation,and Considerate Service”,our business mainly focus on the distribution of electronic components. Line cards we deal with include Microchip,ALPS,ROHM,Xilinx,Pulse,ON,Everlight and Freescale. Main products comprise IC,Modules,Potentiometer,IC Socket,Relay,Connector.Our parts cover such applications as commercial,industrial, and automotives areas.

We are looking forward to setting up business relationship with you and hope to provide you with the best service and solution. Let us make a better world for our industry!



Contact us

Tel: +86-755-8981 8866 Fax: +86-755-8427 6832

Email & Skype: info@chipsmall.com Web: www.chipsmall.com

Address: A1208, Overseas Decoration Building, #122 Zhenhua RD., Futian, Shenzhen, China



To our customers,

Old Company Name in Catalogs and Other Documents

On April 1st, 2010, NEC Electronics Corporation merged with Renesas Technology Corporation, and Renesas Electronics Corporation took over all the business of both companies. Therefore, although the old company name remains in this document, it is a valid Renesas Electronics document. We appreciate your understanding.

Renesas Electronics website: <http://www.renesas.com>

April 1st, 2010
Renesas Electronics Corporation

Issued by: Renesas Electronics Corporation (<http://www.renesas.com>)

Send any inquiries to <http://www.renesas.com/inquiry>.

Notice

1. All information included in this document is current as of the date this document is issued. Such information, however, is subject to change without any prior notice. Before purchasing or using any Renesas Electronics products listed herein, please confirm the latest product information with a Renesas Electronics sales office. Also, please pay regular and careful attention to additional and different information to be disclosed by Renesas Electronics such as that disclosed through our website.
2. Renesas Electronics does not assume any liability for infringement of patents, copyrights, or other intellectual property rights of third parties by or arising from the use of Renesas Electronics products or technical information described in this document. No license, express, implied or otherwise, is granted hereby under any patents, copyrights or other intellectual property rights of Renesas Electronics or others.
3. You should not alter, modify, copy, or otherwise misappropriate any Renesas Electronics product, whether in whole or in part.
4. Descriptions of circuits, software and other related information in this document are provided only to illustrate the operation of semiconductor products and application examples. You are fully responsible for the incorporation of these circuits, software, and information in the design of your equipment. Renesas Electronics assumes no responsibility for any losses incurred by you or third parties arising from the use of these circuits, software, or information.
5. When exporting the products or technology described in this document, you should comply with the applicable export control laws and regulations and follow the procedures required by such laws and regulations. You should not use Renesas Electronics products or the technology described in this document for any purpose relating to military applications or use by the military, including but not limited to the development of weapons of mass destruction. Renesas Electronics products and technology may not be used for or incorporated into any products or systems whose manufacture, use, or sale is prohibited under any applicable domestic or foreign laws or regulations.
6. Renesas Electronics has used reasonable care in preparing the information included in this document, but Renesas Electronics does not warrant that such information is error free. Renesas Electronics assumes no liability whatsoever for any damages incurred by you resulting from errors in or omissions from the information included herein.
7. Renesas Electronics products are classified according to the following three quality grades: “Standard”, “High Quality”, and “Specific”. The recommended applications for each Renesas Electronics product depends on the product’s quality grade, as indicated below. You must check the quality grade of each Renesas Electronics product before using it in a particular application. You may not use any Renesas Electronics product for any application categorized as “Specific” without the prior written consent of Renesas Electronics. Further, you may not use any Renesas Electronics product for any application for which it is not intended without the prior written consent of Renesas Electronics. Renesas Electronics shall not be in any way liable for any damages or losses incurred by you or third parties arising from the use of any Renesas Electronics product for an application categorized as “Specific” or for which the product is not intended where you have failed to obtain the prior written consent of Renesas Electronics. The quality grade of each Renesas Electronics product is “Standard” unless otherwise expressly specified in a Renesas Electronics data sheets or data books, etc.
 - “Standard”: Computers; office equipment; communications equipment; test and measurement equipment; audio and visual equipment; home electronic appliances; machine tools; personal electronic equipment; and industrial robots.
 - “High Quality”: Transportation equipment (automobiles, trains, ships, etc.); traffic control systems; anti-disaster systems; anti-crime systems; safety equipment; and medical equipment not specifically designed for life support.
 - “Specific”: Aircraft; aerospace equipment; submersible repeaters; nuclear reactor control systems; medical equipment or systems for life support (e.g. artificial life support devices or systems), surgical implantations, or healthcare intervention (e.g. excision, etc.), and any other applications or purposes that pose a direct threat to human life.
8. You should use the Renesas Electronics products described in this document within the range specified by Renesas Electronics, especially with respect to the maximum rating, operating supply voltage range, movement power voltage range, heat radiation characteristics, installation and other product characteristics. Renesas Electronics shall have no liability for malfunctions or damages arising out of the use of Renesas Electronics products beyond such specified ranges.
9. Although Renesas Electronics endeavors to improve the quality and reliability of its products, semiconductor products have specific characteristics such as the occurrence of failure at a certain rate and malfunctions under certain use conditions. Further, Renesas Electronics products are not subject to radiation resistance design. Please be sure to implement safety measures to guard them against the possibility of physical injury, and injury or damage caused by fire in the event of the failure of a Renesas Electronics product, such as safety design for hardware and software including but not limited to redundancy, fire control and malfunction prevention, appropriate treatment for aging degradation or any other appropriate measures. Because the evaluation of microcomputer software alone is very difficult, please evaluate the safety of the final products or system manufactured by you.
10. Please contact a Renesas Electronics sales office for details as to environmental matters such as the environmental compatibility of each Renesas Electronics product. Please use Renesas Electronics products in compliance with all applicable laws and regulations that regulate the inclusion or use of controlled substances, including without limitation, the EU RoHS Directive. Renesas Electronics assumes no liability for damages or losses occurring as a result of your noncompliance with applicable laws and regulations.
11. This document may not be reproduced or duplicated, in any form, in whole or in part, without prior written consent of Renesas Electronics.
12. Please contact a Renesas Electronics sales office if you have any questions regarding the information contained in this document or Renesas Electronics products, or if you have any other inquiries.

(Note 1) “Renesas Electronics” as used in this document means Renesas Electronics Corporation and also includes its majority-owned subsidiaries.

(Note 2) “Renesas Electronics product(s)” means any product developed or manufactured by or for Renesas Electronics.

1. Overview

The M16C/62P Group (M16C/62P, M16C/62PT) of single-chip microcomputers are built using the high performance silicon gate CMOS process using a M16C/60 Series CPU core and are packaged in a 80-pin, 100-pin and 128-pin plastic molded QFP. These single-chip microcomputers operate using sophisticated instructions featuring a high level of instruction efficiency. With 1M bytes of address space, they are capable of executing instructions at high speed. In addition, this microcomputer contains a multiplier and DMAC which combined with fast instruction processing capability, makes it suitable for control of various OA, communication, and industrial equipment which requires high-speed arithmetic/logic operations.

1.1 Applications

Audio, cameras, television, home appliance, office/communications/portable/industrial equipment, automobile, etc.

Specifications written in this manual are believed to be accurate, but are not guaranteed to be entirely free of error. Specifications in this manual may be changed for functional or performance improvements. Please make sure your manual is the latest edition.

1.2 Performance Outline

Table 1.1 to 1.3 list Performance Outline of M16C/62P Group (M16C/62P, M16C/62PT)(128-pin version).

Table 1.1 Performance Outline of M16C/62P Group (M16C/62P, M16C/62PT)(128-pin version)

	Item	Performance
		M16C/62P
CPU	Number of Basic Instructions	91 instructions
	Minimum Instruction Execution Time	41.7ns(f(BCLK)=24MHz, VCC1=3.3 to 5.5V) 100ns(f(BCLK)=10MHz, VCC1=2.7 to 5.5V)
	Operating Mode	Single-chip, memory expansion and microprocessor mode
	Address Space	1 Mbyte (Available to 4 Mbytes by memory space expansion function)
	Memory Capacity	See Table 1.4 to 1.5 Product List
Peripheral Function	Port	Input/Output : 113 pins, Input : 1 pin
	Multifunction Timer	Timer A : 16 bits x 5 channels, Timer B : 16 bits x 6 channels, Three phase motor control circuit
	Serial Interface	3 channels Clock synchronous, UART, I ² C bus ⁽¹⁾ , IEBus ⁽²⁾ 2 channels Clock synchronous
	A/D Converter	10-bit A/D converter: 1 circuit, 26 channels
	D/A Converter	8 bits x 2 channels
	DMAC	2 channels
	CRC Calculation Circuit	CCITT-CRC
	Watchdog Timer	15 bits x 1 channel (with prescaler)
	Interrupt	Internal: 29 sources, External: 8 sources, Software: 4 sources, Priority level: 7 levels
	Clock Generation Circuit	4 circuits Main clock generation circuit (*), Subclock generation circuit (*), On-chip oscillator, PLL synthesizer (*)Equipped with a built-in feedback resistor.
	Oscillation Stop Detection Function	Stop detection of main clock oscillation, re-oscillation detection function
	Voltage Detection Circuit	Available (option ⁽⁴⁾)
Electric Characteristics	Supply Voltage	VCC1=3.0 to 5.5 V, VCC2=2.7V to VCC1 (f(BCLK)=24MHz) VCC1=2.7 to 5.5 V, VCC2=2.7V to VCC1 (f(BCLK)=10MHz)
	Power Consumption	14 mA (VCC1=VCC2=5V, f(BCLK)=24MHz) 8 mA (VCC1=VCC2=3V, f(BCLK)=10MHz) 1.8μA (VCC1=VCC2=3V, f(XCIN)=32kHz, wait mode) 0.7μA (VCC1=VCC2=3V, stop mode)
Flash memory version	Program/Erase Supply Voltage	3.3±0.3 V or 5.0±0.5 V
	Program and Erase Endurance	100 times (all area) or 1,000 times (user ROM area without block A and block 1) / 10,000 times (block A, block 1) ⁽³⁾
Operating Ambient Temperature		-20 to 85°C, -40 to 85°C ⁽³⁾
Package		128-pin plastic mold LQFP

NOTES:

- I²C bus is a registered trademark of Koninklijke Philips Electronics N. V.
- IEBus is a registered trademark of NEC Electronics Corporation.
- See **Table 1.8 Product Code** for the program and erase endurance, and operating ambient temperature. In addition 1,000 times/10,000 times are under development as of Jul., 2005. Please inquire about a release schedule.
- All options are on request basis.

Table 1.2 Performance Outline of M16C/62P Group (M16C/62P, M16C/62PT)(100-pin version)

	Item	Performance	
		M16C/62P	M16C/62PT ⁽⁴⁾
CPU	Number of Basic Instructions	91 instructions	
	Minimum Instruction Execution Time	41.7ns(f(BCLK)=24MHz, VCC1=3.3 to 5.5V) 100ns(f(BCLK)=10MHz, VCC1=2.7 to 5.5V)	41.7ns(f(BCLK)=24MHz, VCC1=4.0 to 5.5V)
	Operating Mode	Single-chip, memory expansion and microprocessor mode	Single-chip
	Address Space	1 Mbyte (Available to 4 Mbytes by memory space expansion function)	1 Mbyte
	Memory Capacity	See Table 1.4 to 1.7 Product List	
Peripheral Function	Port	Input/Output : 87 pins, Input : 1 pin	
	Multifunction Timer	Timer A : 16 bits x 5 channels, Timer B : 16 bits x 6 channels, Three phase motor control circuit	
	Serial Interface	3 channels Clock synchronous, UART, I ² C bus ⁽¹⁾ , IEBus ⁽²⁾ 2 channels Clock synchronous	
	A/D Converter	10-bit A/D converter: 1 circuit, 26 channels	
	D/A Converter	8 bits x 2 channels	
	DMAC	2 channels	
	CRC Calculation Circuit	CCITT-CRC	
	Watchdog Timer	15 bits x 1 channel (with prescaler)	
	Interrupt	Internal: 29 sources, External: 8 sources, Software: 4 sources, Priority level: 7 levels	
	Clock Generation Circuit	4 circuits Main clock generation circuit (*), Subclock generation circuit (*), On-chip oscillator, PLL synthesizer (*)Equipped with a built-in feedback resistor.	
	Oscillation Stop Detection Function	Stop detection of main clock oscillation, re-oscillation detection function	
	Voltage Detection Circuit	Available (option ⁽⁵⁾)	Absent
Electric Characteristics	Supply Voltage	VCC1=3.0 to 5.5 V, VCC2=2.7V to VCC1 (f(BCLK)=24MHz) VCC1=2.7 to 5.5 V, VCC2=2.7V to VCC1 (f(BCLK)=10MHz)	VCC1=VCC2=4.0 to 5.5V (f(BCLK)=24MHz)
	Power Consumption	14 mA (VCC1=VCC2=5V, f(BCLK)=24MHz) 8 mA (VCC1=VCC2=3V, f(BCLK)=10MHz) 1.8μA (VCC1=VCC2=3V, f(XCIN)=32kHz, wait mode) 0.7μA (VCC1=VCC2=3V, stop mode)	14 mA (VCC1=VCC2=5V, f(BCLK)=24MHz) 2.0μA (VCC1=VCC2=5V, f(XCIN)=32kHz, wait mode) 0.8μA (VCC1=VCC2=5V, stop mode)
Flash memory version	Program/Erase Supply Voltage	3.3±0.3 V or 5.0±0.5 V	
	Program and Erase Endurance	100 times (all area) or 1,000 times (user ROM area without block A and block 1) / 10,000 times (block A, block 1) ⁽³⁾	
Operating Ambient Temperature	-20 to 85°C, -40 to 85°C ⁽³⁾	T version : -40 to 85°C V version : -40 to 125°C	
Package	100-pin plastic mold QFP, LQFP		

NOTES:

- I²C bus is a registered trademark of Koninklijke Philips Electronics N. V.
- IEBus is a registered trademark of NEC Electronics Corporation.
- See **Table 1.8 and 1.9 Product Code** for the program and erase endurance, and operating ambient temperature.
In addition 1,000 times/10,000 times are under development as of Jul., 2005. Please inquire about a release schedule.
- Use the M16C/62PT on VCC1=VCC2
- All options are on request basis.

Table 1.3 Performance Outline of M16C/62P Group (M16C/62P, M16C/62PT)(80-pin version)

	Item	Performance	
		M16C/62P	M16C/62PT ⁽⁴⁾
CPU	Number of Basic Instructions	91 instructions	
	Minimum Instruction Execution Time	41.7ns(f(BCLK)=24MHz, VCC1=3.3 to 5.5V) 100ns(f(BCLK)=10MHz, VCC1=2.7 to 5.5V)	41.7ns(f(BCLK)=24MHz, VCC1=4.0 to 5.5V)
	Operating Mode	Single-chip mode	
	Address Space	1 Mbyte	
	Memory Capacity	See Table 1.4 to 1.7 Product List	
Peripheral Function	Port	Input/Output : 70 pins, Input : 1 pin	
	Multifunction Timer	Timer A : 16 bits x 5 channels (Timer A1 and A2 are internal timer), Timer B : 16 bits x 6 channels (Timer B1 is internal timer)	
	Serial Interface	2 channels Clock synchronous, UART, I ² C bus ⁽¹⁾ , IEBus ⁽²⁾ 1 channel Clock synchronous, I ² C bus ⁽¹⁾ , IEBus ⁽²⁾ 2 channels Clock synchronous (1 channel is only transmission)	
	A/D Converter	10-bit A/D converter: 1 circuit, 26 channels	
	D/A Converter	8 bits x 2 channels	
	DMAC	2 channels	
	CRC Calculation Circuit	CCITT-CRC	
	Watchdog Timer	15 bits x 1 channel (with prescaler)	
	Interrupt	Internal: 29 sources, External: 5 sources, Software: 4 sources, Priority level: 7 levels	
	Clock Generation Circuit	4 circuits Main clock generation circuit (*), Subclock generation circuit (*), On-chip oscillator, PLL synthesizer (*)Equipped with a built-in feedback resistor.	
	Oscillation Stop Detection Function	Stop detection of main clock oscillation, re-oscillation detection function	
	Voltage Detection Circuit	Available (option ⁽⁴⁾)	Absent
	Electric Characteristics	Supply Voltage	VCC1=3.0 to 5.5 V, (f(BCLK)=24MHz) VCC1=2.7 to 5.5 V, (f(BCLK)=10MHz)
Power Consumption		14 mA (VCC1=5V, f(BCLK)=24MHz) 8 mA (VCC1=3V, f(BCLK)=10MHz) 1.8μA (VCC1=3V, f(XCIN)=32kHz, wait mode) 0.7μA (VCC1=3V, stop mode)	14 mA (VCC1=5V, f(BCLK)=24MHz) 2.0μA (VCC1=5V, f(XCIN)=32kHz, wait mode) 0.8μA (VCC1=5V, stop mode)
Flash memory version	Program/Erase Supply Voltage	3.3 ± 0.3V or 5.0 ± 0.5V	5.0 ± 0.5V
	Program and Erase Endurance	100 times (all area) or 1,000 times (user ROM area without block A and block 1) / 10,000 times (block A, block 1) ⁽³⁾	
Operating Ambient Temperature	-20 to 85°C, -40 to 85°C ⁽³⁾	T version : -40 to 85°C V version : -40 to 125°C	
Package	80-pin plastic mold QFP		

NOTES:

- I²C bus is a registered trademark of Koninklijke Philips Electronics N. V.
- IEBus is a registered trademark of NEC Electronics Corporation.
- See **Table 1.8 and 1.9 Product Code** for the program and erase endurance, and operating ambient temperature.
In addition 1,000 times/10,000 times are under development as of Jul., 2005. Please inquire about a release schedule.
- All options are on request basis.

1.3 Block Diagram

Figure 1.1 is a M16C/62P Group (M16C/62P, M16C/62PT) 128-pin and 100-pin version Block Diagram, Figure 1.2 is a M16C/62P Group (M16C/62P, M16C/62PT) 80-pin version Block Diagram.

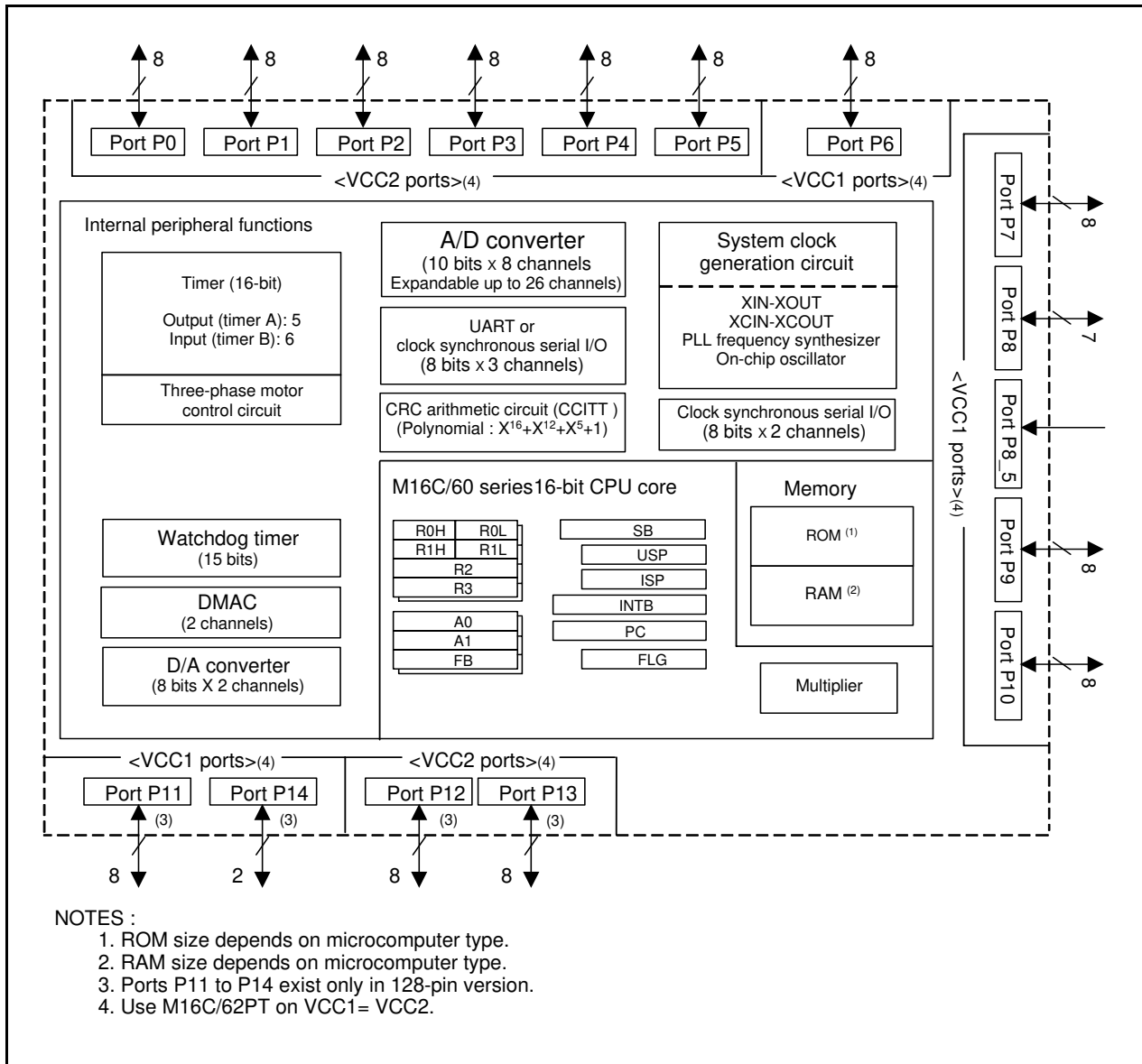

Figure 1.1 M16C/62P Group (M16C/62P, M16C/62PT) 128-pin and 100-pin version Block Diagram

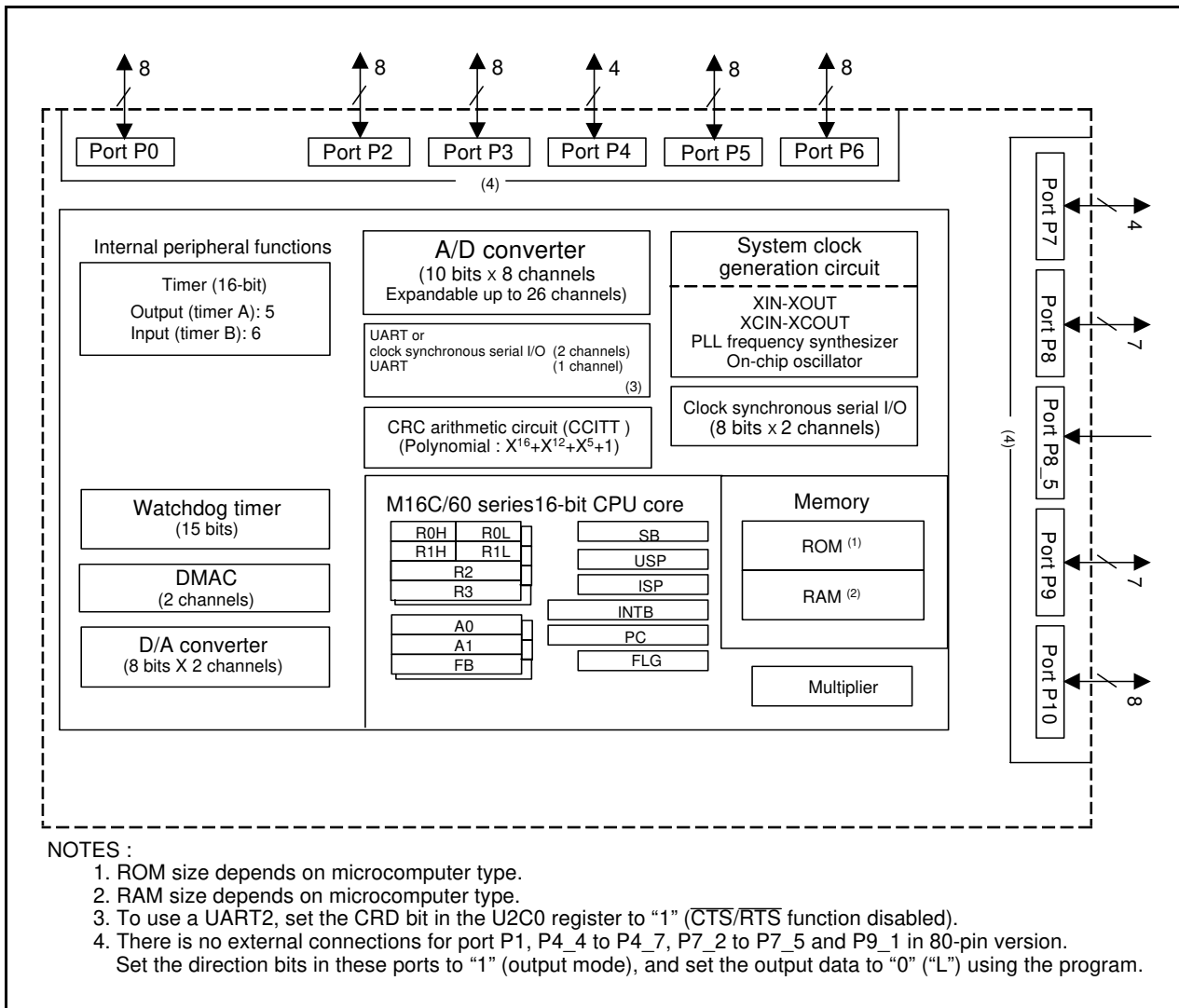

Figure 1.2 M16C/62P Group (M16C/62P, M16C/62PT) 80-pin version Block Diagram

1.4 Product List

Table 1.4 to 1.7 list the product list, Figure 1.3 shows the Type No., Memory Size, and Package, Table 1.8 lists the Product Code of Flash Memory version and ROMless version for M16C/62P, and Table 1.9 lists the Product Code of Flash Memory version for M16C/62PT. Figure 1.4 shows the Marking Diagram of Flash Memory version and ROM-less version for M16C/62P (Top View), and Figure 1.5 shows the Marking Diagram of Flash Memory version for M16C/62PT (Top View) at the time of ROM order.

Table 1.4 Product List (1) (M16C/62P)

As of Dec. 2005

Type No.	ROM Capacity	RAM Capacity	Package Type ⁽¹⁾	Remarks
M30622M6P-XXXFP	48 Kbytes	4 Kbytes	PRQP0100JB-A	Mask ROM version
M30622M6P-XXXGP			PLQP0100KB-A	
M30622M8P-XXXFP	64 Kbytes	4 Kbytes	PRQP0100JB-A	
M30622M8P-XXXGP			PLQP0100KB-A	
M30623M8P-XXXGP			PRQP0080JA-A	
M30622MAP-XXXFP	96 Kbytes	5 Kbytes	PRQP0100JB-A	
M30622MAP-XXXGP			PLQP0100KB-A	
M30623MAP-XXXGP			PRQP0080JA-A	
M30620MCP-XXXFP	128 Kbytes	10 Kbytes	PRQP0100JB-A	
M30620MCP-XXXGP			PLQP0100KB-A	
M30621MCP-XXXGP			PRQP0080JA-A	
M30622MEP-XXXFP	192 Kbytes	12 Kbytes	PRQP0100JB-A	
M30622MEP-XXXGP			PLQP0100KB-A	
M30623MEP-XXXGP			PLQP0128KB-A	
M30622MGP-XXXFP	256 Kbytes	12 Kbytes	PRQP0100JB-A	
M30622MGP-XXXGP			PLQP0100KB-A	
M30623MGP-XXXGP			PLQP0128KB-A	
M30624MGP-XXXFP		20 Kbytes	PRQP0100JB-A	
M30624MGP-XXXGP			PLQP0100KB-A	
M30625MGP-XXXGP			PLQP0128KB-A	
M30622MWP-XXXFP	320 Kbytes	16 Kbytes	PRQP0100JB-A	
M30622MWP-XXXGP			PLQP0100KB-A	
M30623MWP-XXXGP			PLQP0128KB-A	
M30624MWP-XXXFP		24 Kbytes	PRQP0100JB-A	
M30624MWP-XXXGP			PLQP0100KB-A	
M30625MWP-XXXGP			PLQP0128KB-A	
M30626MWP-XXXFP		31 Kbytes	PRQP0100JB-A	
M30626MWP-XXXGP			PLQP0100KB-A	
M30627MWP-XXXGP			PLQP0128KB-A	

(D): Under development

NOTES:

- The old package type numbers of each package type are as follows.
 PLQP0128KB-A : 128P6Q-A,
 PRQP0100JB-A : 100P6S-A,
 PLQP0100KB-A : 100P6Q-A,
 PRQP0080JA-A : 80P6S-A

Table 1.5 Product List (2) (M16C/62P)

As of Dec. 2005

Type No.	ROM Capacity	RAM Capacity	Package Type (1)	Remarks	
M30622MHP-XXXFP	384 Kbytes	16 Kbytes	PRQP0100JB-A	Mask ROM version	
M30622MHP-XXXGP			PLQP0100KB-A		
M30623MHP-XXXGP			PLQP0128KB-A		
M30624MHP-XXXFP		24 Kbytes	PRQP0100JB-A		
M30624MHP-XXXGP			PLQP0100KB-A		
M30625MHP-XXXGP			PLQP0128KB-A		
M30626MHP-XXXFP		31 Kbytes	PRQP0100JB-A		
M30626MHP-XXXGP			PLQP0100KB-A		
M30627MHP-XXXGP			PLQP0128KB-A		
M30626MJP-XXXFP (D)	512 Kbytes	31 Kbytes	PRQP0100JB-A		
M30626MJP-XXXGP (D)			PLQP0100KB-A		
M30627MJP-XXXGP (D)			PLQP0128KB-A		
M30622F8PFP	64K+4 Kbytes	4 Kbytes	PRQP0100JB-A	Flash memory version (2)	
M30622F8PGP			PLQP0100KB-A		
M30623F8PGP			PRQP0080JA-A		
M30620FCPFP	128K+4 Kbytes	10 Kbytes	PRQP0100JB-A		
M30620FCPGP			PLQP0100KB-A		
M30621FCPGP			PRQP0080JA-A		
M3062LFGPFP(3) (D)	256K+4 Kbytes	20 Kbytes	PRQP0100JB-A		
M3062LFGPGP(3) (D)			PLQP0100KB-A		
M30625FGPGP			PLQP0128KB-A		
M30626FHPFP	384K+4 Kbytes	31 Kbytes	PRQP0100JB-A		
M30626FHPPGP			PLQP0100KB-A		
M30627FHPPGP			PLQP0128KB-A		
M30626FJPFP	512K+4 Kbytes	31 Kbytes	PRQP0100JB-A		
M30626FJPGP			PLQP0100KB-A		
M30627FJPGP			PLQP0128KB-A		
M30622SPFP	-	4 Kbytes	PRQP0100JB-A	ROM-less version	
M30622SPGP			PLQP0100KB-A		
M30620SPFP		10 Kbytes	PRQP0100JB-A		
M30620SPGP			PLQP0100KB-A		
M30624SPFP (D)	-	20 Kbytes	PRQP0100JB-A		
M30624SPGP (D)			PLQP0100KB-A		
M30626SPFP (D)		31 Kbytes	PRQP0100JB-A		
M30626SPGP (D)			PLQP0100KB-A		

(D): Under development

NOTES:

- The old package type numbers of each package type are as follows.
 PLQP0128KB-A : 128P6Q-A,
 PRQP0100JB-A : 100P6S-A,
 PLQP0100KB-A : 100P6Q-A,
 PRQP0080JA-A : 80P6S-A
- In the flash memory version, there is 4K bytes area (block A).
- Please use M3062LFGPFP and M3062LFGPGP for your new system instead of M30624FGPFP and M30624FGPGP. The M16C/62P Group (M16C/62P, M16C/62PT) hardware manual is still good for M30624FGPFP and M30624FGPGP.

M30624FGPFP	256K+4 Kbytes	20 Kbytes	PRQP0100JB-A	Flash memory version
M30624FGPGP			PLQP0100KB-A	

Table 1.6 Product List (3) (T version (M16C/62PT)) As of Dec. 2005

Type No.	ROM Capacity	RAM Capacity	Package Type (1)	Remarks		
M3062CM6T-XXXFP (D)	48 Kbytes	4 Kbytes	PRQP0100JB-A	Mask ROM version	T Version (High reliability 85°C version)	
M3062CM6T-XXXGP (D)			PLQP0100KB-A			
M3062EM6T-XXXGP (P)			PRQP0080JA-A			
M3062CM8T-XXXFP (D)	64 Kbytes	4 Kbytes	PRQP0100JB-A			
M3062CM8T-XXXGP (D)			PLQP0100KB-A			
M3062EM8T-XXXGP (P)			PRQP0080JA-A			
M3062CMAT-XXXFP (D)	96 Kbytes	5 Kbytes	PRQP0100JB-A			
M3062CMAT-XXXGP (D)			PLQP0100KB-A			
M3062EMAT-XXXGP (P)			PRQP0080JA-A			
M3062AMCT-XXXFP (D)	128 Kbytes	10 Kbytes	PRQP0100JB-A			
M3062AMCT-XXXGP (D)			PLQP0100KB-A			
M3062BMCT-XXXGP (P)			PRQP0080JA-A			
M3062CF8TFP (D)	64 K+4 Kbytes	4 Kbytes	PRQP0100JB-A			Flash memory version (2)
M3062CF8TGP			PLQP0100KB-A			
M3062AFCTFP (D)	128K+4 Kbytes	10 Kbytes	PRQP0100JB-A			
M3062AFCTGP (D)			PLQP0100KB-A			
M3062BFCTGP (P)			PRQP0080JA-A			
M3062JFHTFP (D)	384K+4 Kbytes	31 Kbytes	PRQP0100JB-A			
M3062JFHTGP (D)			PLQP0100KB-A			

(D): Under development

(P): Under planning

NOTES:

- The old package type numbers of each package type are as follows.
PRQP0100JB-A : 100P6S-A,
PLQP0100KB-A : 100P6Q-A,
PRQP0080JA-A : 80P6S-A
- In the flash memory version, there is 4K bytes area (block A).

Table 1.7 Product List (4) (V version (M16C/62PT)) As of Dec. 2005

Type No.	ROM Capacity	RAM Capacity	Package Type ⁽¹⁾	Remarks		
M3062CM6V-XXXFP (P)	48 Kbytes	4 Kbytes	PRQP0100JB-A	Mask ROM version	V Version (High reliability 125°C version)	
M3062CM6V-XXXGP (P)			PLQP0100KB-A			
M3062EM6V-XXXGP (P)			PRQP0080JA-A			
M3062CM8V-XXXFP (P)	64 Kbytes	4 Kbytes	PRQP0100JB-A			
M3062CM8V-XXXGP (P)			PLQP0100KB-A			
M3062EM8V-XXXGP (P)			PRQP0080JA-A			
M3062CMAV-XXXFP (P)	96 Kbytes	5 Kbytes	PRQP0100JB-A			
M3062CMAV-XXXGP (P)			PLQP0100KB-A			
M3062EMAV-XXXGP (P)			PRQP0080JA-A			
M3062AMCV-XXXFP (D)	128 Kbytes	10 Kbytes	PRQP0100JB-A			Flash memory version ⁽²⁾
M3062AMCV-XXXGP (D)			PLQP0100KB-A			
M3062BMCV-XXXGP (P)			PRQP0080JA-A			
M3062AFCVFP (D)	128K+4 Kbytes	10 Kbytes	PRQP0100JB-A			
M3062AFCVGP (D)			PLQP0100KB-A			
M3062BFCVGP (P)			PRQP0080JA-A			
M3062JFHVFP (P)	384K+4 Kbytes	31 Kbytes	PRQP0100JB-A			
M3062JFHVGP (P)			PLQP0100KB-A			

(D): Under development

(P): Under planning

NOTES:

- The old package type numbers of each package type are as follows.
 PLQP0128KB-A : 128P6Q-A,
 PRQP0100JB-A : 100P6S-A,
 PLQP0100KB-A : 100P6Q-A,
 PRQP0080JA-A : 80P6S-A
- In the flash memory version, there is 4K bytes area (block A).

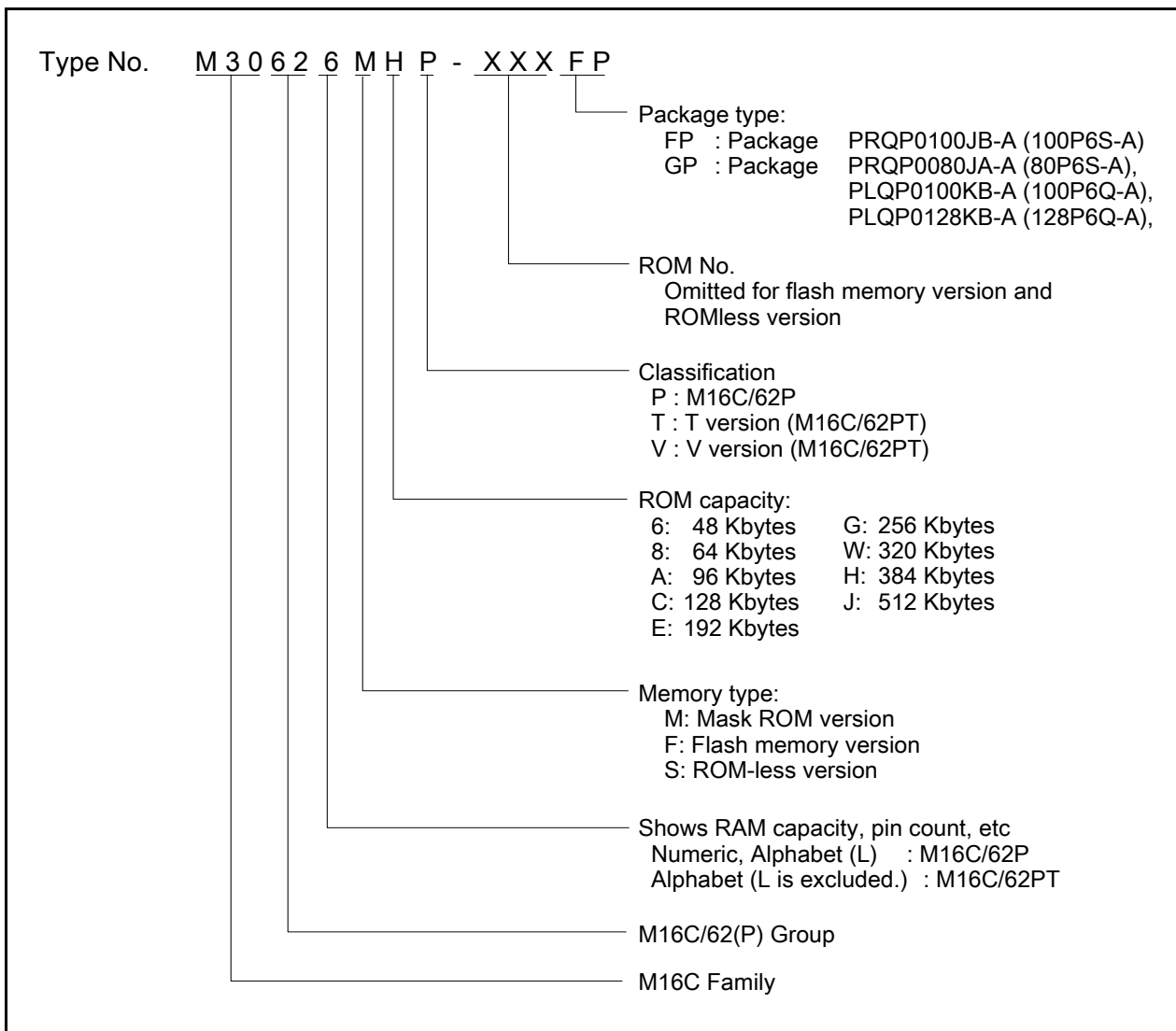

Figure 1.3 Type No., Memory Size, and Package

Table 1.8 Product Code of Flash Memory version and ROMless version for M16C/62P

	Product Code	Package	Internal ROM (User ROM Area Without Block A, Block 1)		Internal ROM (Block A, Block 1)		Operating Ambient Temperature
			Program and Erase Endurance	Temperature Range	Program and Erase Endurance	Temperature Range	
Flash memory Version	D3	Lead-included	100	0°C to 60°C	100	0°C to 60°C	-40°C to 85°C
	D5						-20°C to 85°C
	D7		1,000		10,000	-40°C to 85°C	
	D9					-20°C to 85°C	
	U3	Lead-free	100		100	0°C to 60°C	-40°C to 85°C
	U5						-20°C to 85°C
	U7		1,000		10,000	-40°C to 85°C	-40°C to 85°C
	U9						-20°C to 85°C
ROM-less version	D3	Lead-included	-	-	-	-	-40°C to 85°C
	D5		-	-	-	-	-20°C to 85°C
	U3	Lead-free	-	-	-	-	-40°C to 85°C
	U5		-	-	-	-	-20°C to 85°C

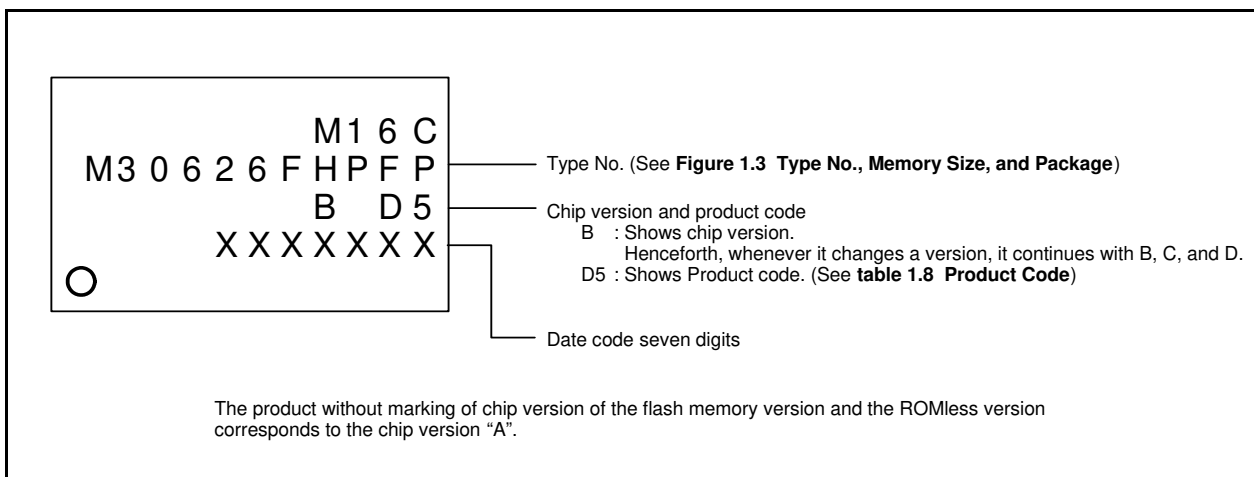

Figure 1.4 Marking Diagram of Flash Memory version and ROM-less version for M16C/62P (Top View)

Table 1.9 Product Code of Flash Memory version for M16C/62PT

	Flash memory Version	T Version V Version	Product Code	Package	Internal ROM (User ROM Area Without Block A, Block 1)		Internal ROM (Block A, Block 1)		Operating Ambient Temperature
					Program and Erase Endurance	Temperature Range	Program and Erase Endurance	Temperature Range	
Flash memory Version	T Version	B	Lead-included	100	0°C to 60°C	100	0°C to 60°C	-40°C to 85°C	
	V Version							-40°C to 125°C	
	T Version	B7	Lead-free	1,000	10,000	-40°C to 85°C	-40°C to 85°C		
	V Version						-40°C to 125°C		
	T Version	U	Lead-free	100	100	0°C to 60°C	-40°C to 85°C		
	V Version						-40°C to 125°C		
	T Version	U7	Lead-free	1,000	10,000	-40°C to 85°C	-40°C to 85°C		
	V Version						-40°C to 125°C		

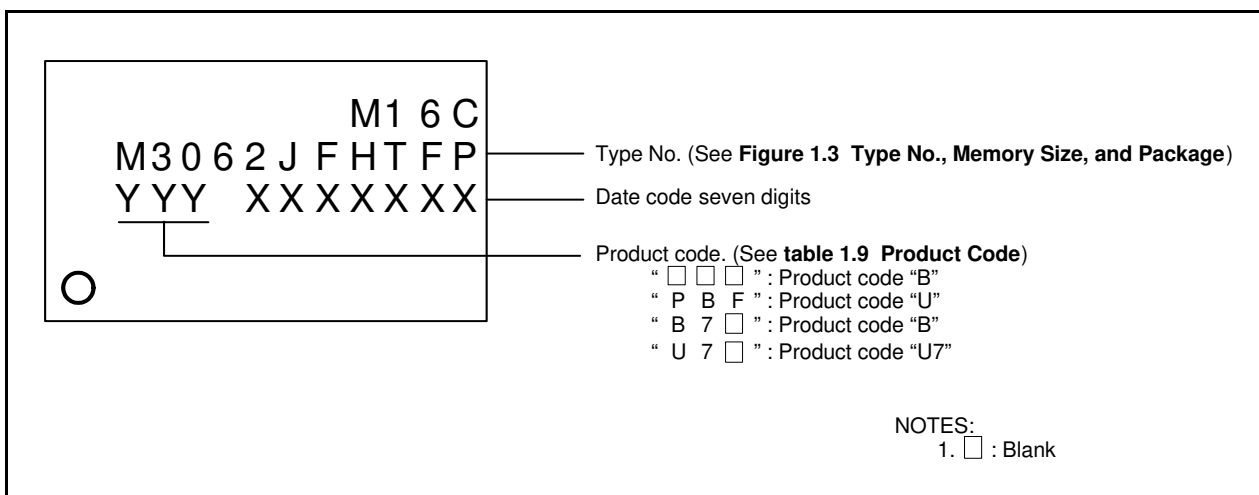

Figure 1.5 Marking Diagram of Flash Memory version for M16C/62PT (Top View)

1.5 Pin Configuration

Figures 1.6 to 1.9 show the Pin Configuration (Top View).

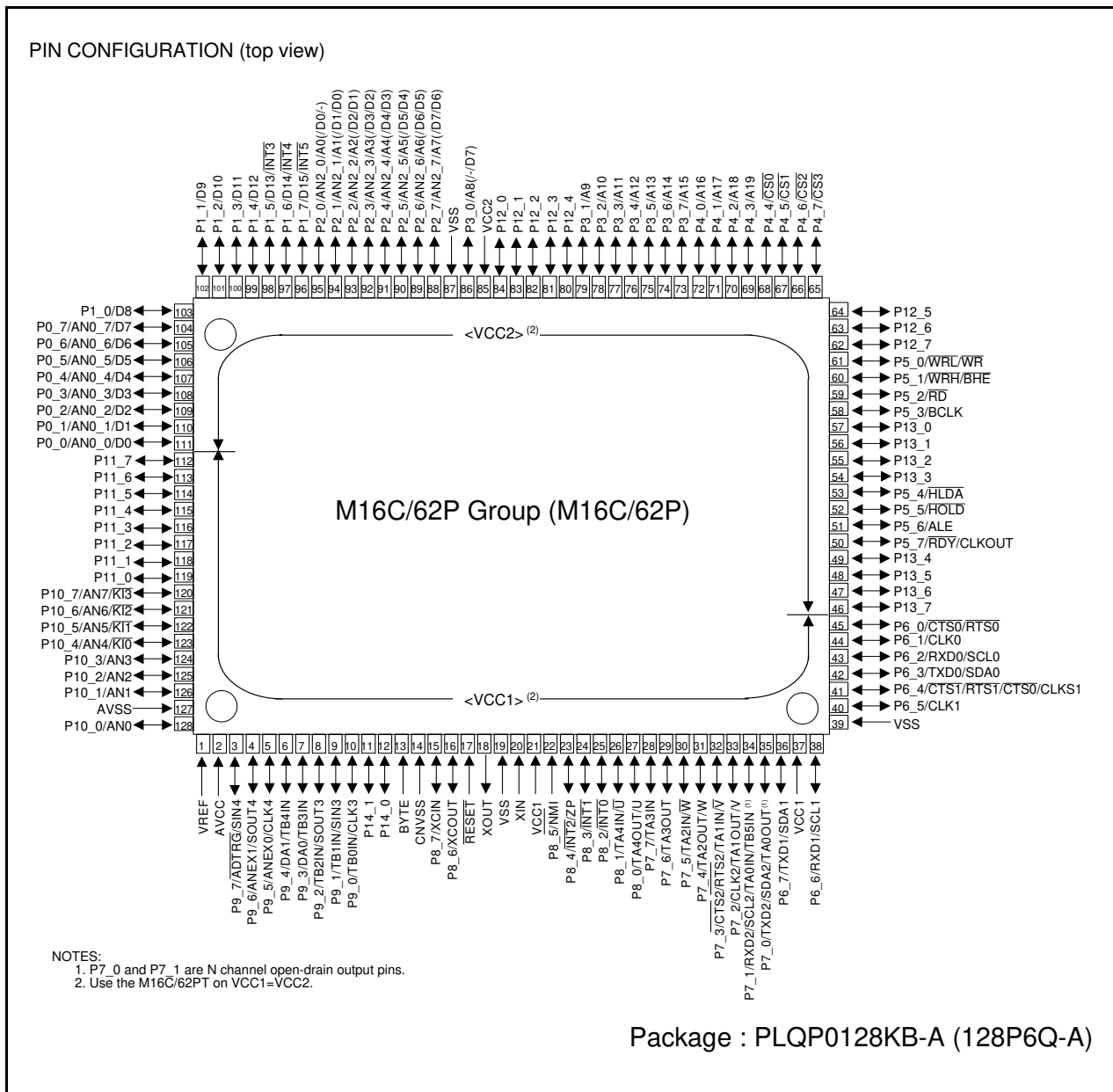

Figure 1.6 Pin Configuration (Top View)

Table 1.10 Pin Characteristics for 128-Pin Package (1)

Pin No.	Control Pin	Port	Interrupt Pin	Timer Pin	UART Pin	Analog Pin	Bus Control Pin
1	VREF						
2	AVCC						
3		P9_7			SIN4	ADTRG	
4		P9_6			SOUT4	ANEX1	
5		P9_5			CLK4	ANEX0	
6		P9_4		TB4IN		DA1	
7		P9_3		TB3IN		DA0	
8		P9_2		TB2IN	SOUT3		
9		P9_1		TB1IN	SIN3		
10		P9_0		TB0IN	CLK3		
11		P14_1					
12		P14_0					
13	BYTE						
14	CNVSS						
15	XCIN	P8_7					
16	XCOU	P8_6					
17	RESET						
18	XOUT						
19	VSS						
20	XIN						
21	VCC1						
22		P8_5	NMI				
23		P8_4	INT2	ZP			
24		P8_3	INT1				
25		P8_2	INT0				
26		P8_1		TA4IN/U			
27		P8_0		TA4OUT/U			
28		P7_7		TA3IN			
29		P7_6		TA3OUT			
30		P7_5		TA2IN/W			
31		P7_4		TA2OUT/W			
32		P7_3		TA1IN/V	CTS2/RTS2		
33		P7_2		TA1OUT/V	CLK2		
34		P7_1		TA0IN/TB5IN	RXD2/SCL2		
35		P7_0		TA0OUT	TXD2/SDA2		
36		P6_7			TXD1/SDA1		
37	VCC1						
38		P6_6			RXD1/SCL1		
39	VSS						
40		P6_5			CLK1		
41		P6_4			CTS1/RTS1/CTS0/CLKS1		
42		P6_3			TXD0/SDA0		
43		P6_2			RXD0/SCL0		
44		P6_1			CLK0		
45		P6_0			CTS0/RTS0		
46		P13_7					
47		P13_6					
48		P13_5					
49		P13_4					
50		P5_7					RDY/CLKOUT

Table 1.11 Pin Characteristics for 128-Pin Package (2)

Pin No.	Control Pin	Port	Interrupt Pin	Timer Pin	UART Pin	Analog Pin	Bus Control Pin
51		P5_6					ALE
52		P5_5					$\overline{\text{HOLD}}$
53		P5_4					$\overline{\text{HLDA}}$
54		P13_3					
55		P13_2					
56		P13_1					
57		P13_0					
58		P5_3					BCLK
59		P5_2					$\overline{\text{RD}}$
60		P5_1					$\overline{\text{WRH/BHE}}$
61		P5_0					$\overline{\text{WRL/WR}}$
62		P12_7					
63		P12_6					
64		P12_5					
65		P4_7					$\overline{\text{CS3}}$
66		P4_6					$\overline{\text{CS2}}$
67		P4_5					$\overline{\text{CS1}}$
68		P4_4					$\overline{\text{CS0}}$
69		P4_3					A19
70		P4_2					A18
71		P4_1					A17
72		P4_0					A16
73		P3_7					A15
74		P3_6					A14
75		P3_5					A13
76		P3_4					A12
77		P3_3					A11
78		P3_2					A10
79		P3_1					A9
80		P12_4					
81		P12_3					
82		P12_2					
83		P12_1					
84		P12_0					
85	VCC2						
86		P3_0					A8(/-D7)
87	VSS						
88		P2_7				AN2_7	A7(/D7/D6)
89		P2_6				AN2_6	A6(/D6/D5)
90		P2_5				AN2_5	A5(/D5/D4)
91		P2_4				AN2_4	A4(/D4/D3)
92		P2_3				AN2_3	A3(/D3/D2)
93		P2_2				AN2_2	A2(/D2/D1)
94		P2_1				AN2_1	A1(/D1/D0)
95		P2_0				AN2_0	A0(/D0/-)
96		P1_7	$\overline{\text{INT5}}$				D15
97		P1_6	$\overline{\text{INT4}}$				D14
98		P1_5	$\overline{\text{INT3}}$				D13
99		P1_4					D12
100		P1_3					D11

Table 1.12 Pin Characteristics for 128-Pin Package (3)

Pin No.	Control Pin	Port	Interrupt Pin	Timer Pin	UART Pin	Analog Pin	Bus Control Pin
101		P1_2					D10
102		P1_1					D9
103		P1_0					D8
104		P0_7				AN0_7	D7
105		P0_6				AN0_6	D6
106		P0_5				AN0_5	D5
107		P0_4				AN0_4	D4
108		P0_3				AN0_3	D3
109		P0_2				AN0_2	D2
110		P0_1				AN0_1	D1
111		P0_0				AN0_0	D0
112		P11_7					
113		P11_6					
114		P11_5					
115		P11_4					
116		P11_3					
117		P11_2					
118		P11_1					
119		P11_0					
120		P10_7	$\overline{KI3}$			AN7	
121		P10_6	$\overline{KI2}$			AN6	
122		P10_5	$\overline{KI1}$			AN5	
123		P10_4	$\overline{KI0}$			AN4	
124		P10_3				AN3	
125		P10_2				AN2	
126		P10_1				AN1	
127	AVSS						
128		P10_0				AN0	

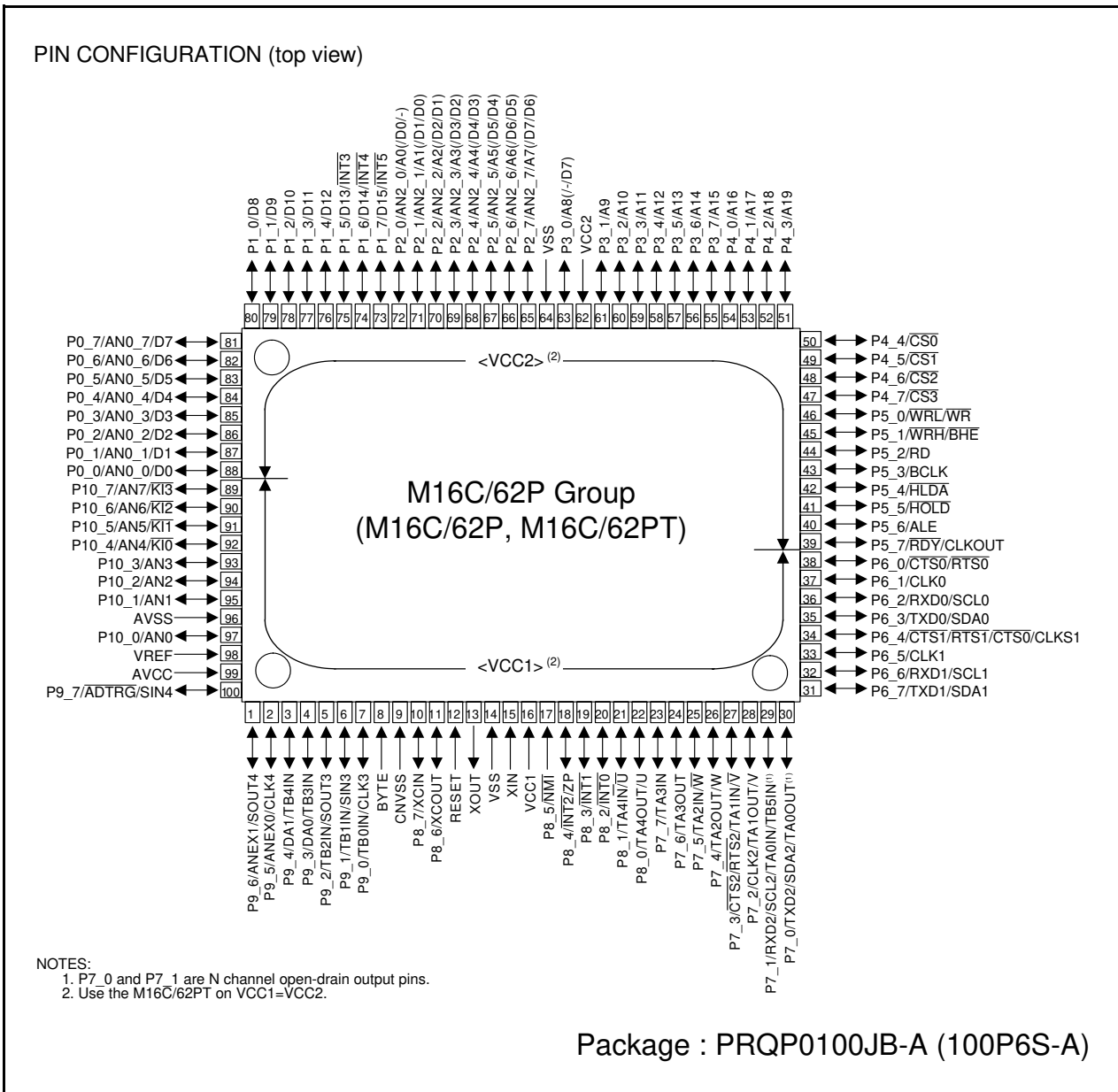

Figure 1.7 Pin Configuration (Top View)

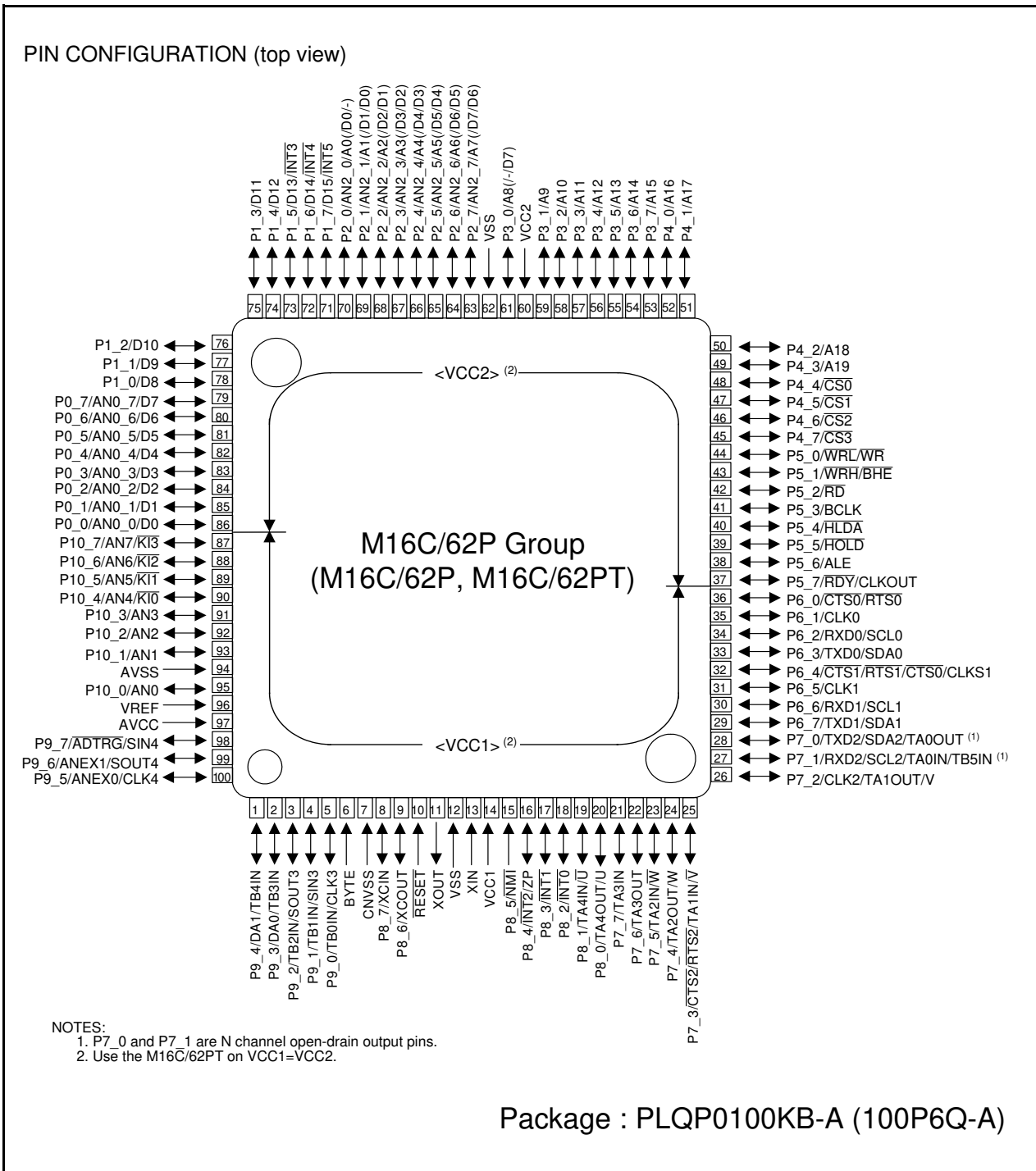

Figure 1.8 Pin Configuration (Top View)

Table 1.13 Pin Characteristics for 100-Pin Package (1)

Pin No.		Control Pin	Port	Interrupt Pin	Timer Pin	UART Pin	Analog Pin	Bus Control Pin
FP	GP							
1	99		P9_6			SOUT4	ANEX1	
2	100		P9_5			CLK4	ANEX0	
3	1		P9_4		TB4IN		DA1	
4	2		P9_3		TB3IN		DA0	
5	3		P9_2		TB2IN	SOUT3		
6	4		P9_1		TB1IN	SIN3		
7	5		P9_0		TB0IN	CLK3		
8	6	BYTE						
9	7	CNVSS						
10	8	XCIN	P8_7					
11	9	XCOUT	P8_6					
12	10	$\overline{\text{RESET}}$						
13	11	XOUT						
14	12	VSS						
15	13	XIN						
16	14	VCC1						
17	15		P8_5	$\overline{\text{NMI}}$				
18	16		P8_4	$\overline{\text{INT2}}$	ZP			
19	17		P8_3	$\overline{\text{INT1}}$				
20	18		P8_2	$\overline{\text{INT0}}$				
21	19		P8_1		TA4IN/ $\overline{\text{U}}$			
22	20		P8_0		TA4OUT/ $\overline{\text{U}}$			
23	21		P7_7		TA3IN			
24	22		P7_6		TA3OUT			
25	23		P7_5		TA2IN/ $\overline{\text{W}}$			
26	24		P7_4		TA2OUT/ $\overline{\text{W}}$			
27	25		P7_3		TA1IN/ $\overline{\text{V}}$	$\overline{\text{CTS2}}/\overline{\text{RTS2}}$		
28	26		P7_2		TA1OUT/ $\overline{\text{V}}$	CLK2		
29	27		P7_1		TA0IN/TB5IN	RXD2/SCL2		
30	28		P7_0		TA0OUT	TXD2/SDA2		
31	29		P6_7			TXD1/SDA1		
32	30		P6_6			RXD1/SCL1		
33	31		P6_5			CLK1		
34	32		P6_4			$\overline{\text{CTS1}}/\overline{\text{RTS1}}/\overline{\text{CTS0}}/\overline{\text{CLKS1}}$		
35	33		P6_3			TXD0/SDA0		
36	34		P6_2			RXD0/SCL0		
37	35		P6_1			CLK0		
38	36		P6_0			$\overline{\text{CTS0}}/\overline{\text{RTS0}}$		
39	37		P5_7					$\overline{\text{RDY}}/\overline{\text{CLKOUT}}$
40	38		P5_6					ALE
41	39		P5_5					$\overline{\text{HOLD}}$
42	40		P5_4					$\overline{\text{HLAD}}$
43	41		P5_3					BCLK
44	42		P5_2					$\overline{\text{RD}}$
45	43		P5_1					$\overline{\text{WRH}}/\overline{\text{BHE}}$
46	44		P5_0					$\overline{\text{WRL}}/\overline{\text{WR}}$
47	45		P4_7					$\overline{\text{CS3}}$
48	46		P4_6					$\overline{\text{CS2}}$
49	47		P4_5					$\overline{\text{CS1}}$
50	48		P4_4					$\overline{\text{CS0}}$

Table 1.14 Pin Characteristics for 100-Pin Package (2)

Pin No.		Control Pin	Port	Interrupt Pin	Timer Pin	UART Pin	Analog Pin	Bus Control Pin
FP	GP							
51	49		P4_3					A19
52	50		P4_2					A18
53	51		P4_1					A17
54	52		P4_0					A16
55	53		P3_7					A15
56	54		P3_6					A14
57	55		P3_5					A13
58	56		P3_4					A12
59	57		P3_3					A11
60	58		P3_2					A10
61	59		P3_1					A9
62	60	VCC2						
63	61		P3_0					A8(/-D7)
64	62	VSS						
65	63		P2_7				AN2_7	A7(/D7/D6)
66	64		P2_6				AN2_6	A6(/D6/D5)
67	65		P2_5				AN2_5	A5(/D5/D4)
68	66		P2_4				AN2_4	A4(/D4/D3)
69	67		P2_3				AN2_3	A3(/D3/D2)
70	68		P2_2				AN2_2	A2(/D2/D1)
71	69		P2_1				AN2_1	A1(/D1/D0)
72	70		P2_0				AN2_0	A0(/D0/-)
73	71		P1_7	$\overline{\text{INT5}}$				D15
74	72		P1_6	$\overline{\text{INT4}}$				D14
75	73		P1_5	$\overline{\text{INT3}}$				D13
76	74		P1_4					D12
77	75		P1_3					D11
78	76		P1_2					D10
79	77		P1_1					D9
80	78		P1_0					D8
81	79		P0_7				AN0_7	D7
82	80		P0_6				AN0_6	D6
83	81		P0_5				AN0_5	D5
84	82		P0_4				AN0_4	D4
85	83		P0_3				AN0_3	D3
86	84		P0_2				AN0_2	D2
87	85		P0_1				AN0_1	D1
88	86		P0_0				AN0_0	D0
89	87		P10_7	$\overline{\text{KI3}}$			AN7	
90	88		P10_6	$\overline{\text{KI2}}$			AN6	
91	89		P10_5	$\overline{\text{KI1}}$			AN5	
92	90		P10_4	$\overline{\text{KI0}}$			AN4	
93	91		P10_3				AN3	
94	92		P10_2				AN2	
95	93		P10_1				AN1	
96	94	AVSS						
97	95		P10_0				AN0	
98	96	VREF						
99	97	AVCC						
100	98		P9_7			SIN4	$\overline{\text{ADTRG}}$	

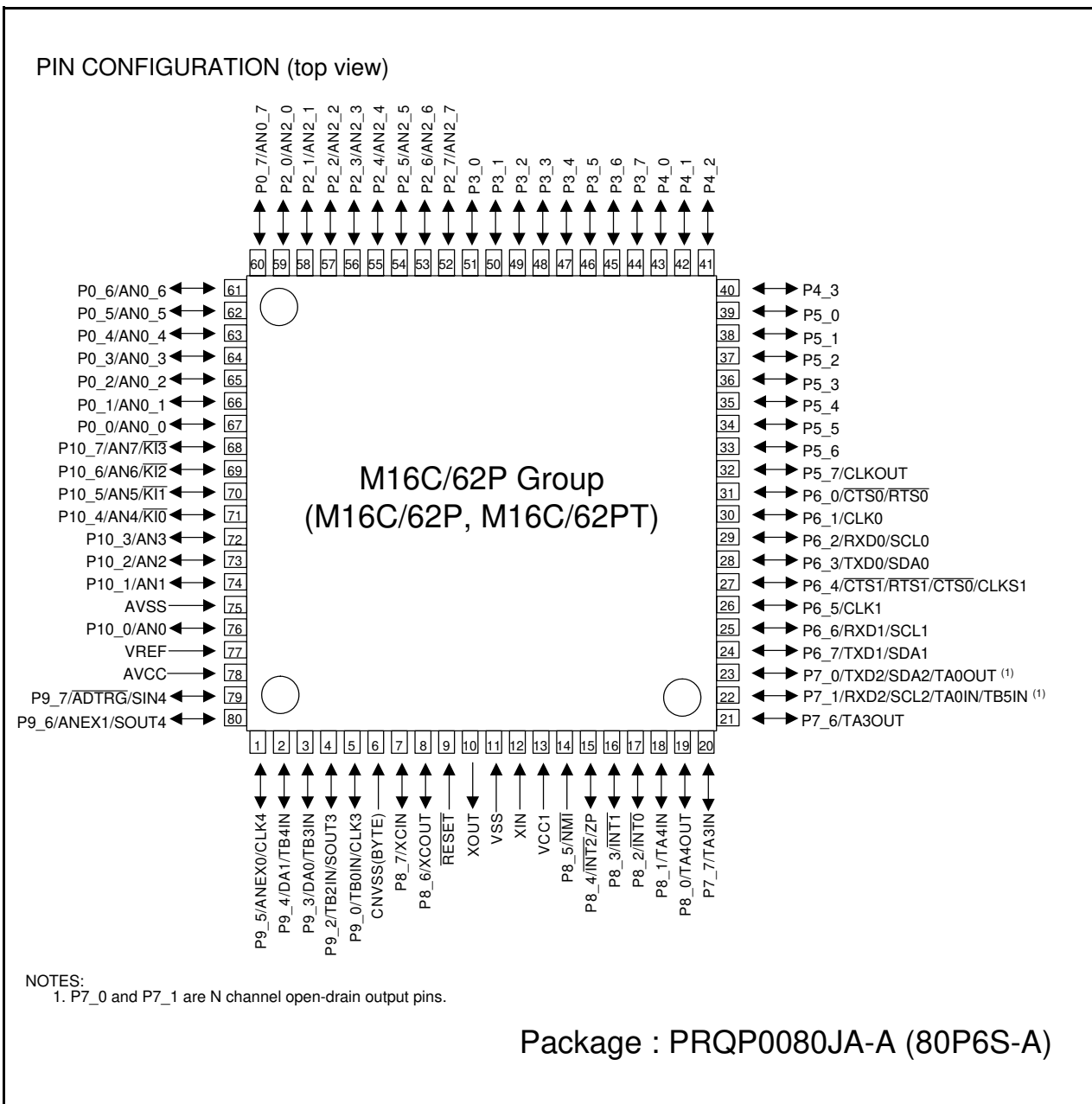

Figure 1.9 Pin Configuration (Top View)

Table 1.15 Pin Characteristics for 80-Pin Package (1)

Pin No.	Control Pin	Port	Interrupt Pin	Timer Pin	UART Pin	Analog Pin	Bus Control Pin
1		P9_5			CLK4	ANEX0	
2		P9_4		TB4IN		DA1	
3		P9_3		TB3IN		DA0	
4		P9_2		TB2IN	SOUT3		
5		P9_0		TB0IN	CLK3		
6	CNVSS (BYTE)						
7	XCIN	P8_7					
8	XCOUT	P8_6					
9	RESET						
10	XOUT						
11	VSS						
12	XIN						
13	VCC1						
14		P8_5	NMI				
15		P8_4	INT2	ZP			
16		P8_3	INT1				
17		P8_2	INT0				
18		P8_1		TA4IN			
19		P8_0		TA4OUT			
20		P7_7		TA3IN			
21		P7_6		TA3OUT			
22		P7_1		TA0IN/TB5IN	RXD2/SCL2		
23		P7_0		TA0OUT	TXD2/SDA2		
24		P6_7			TXD1/SDA1		
25		P6_6			RXD1/SCL1		
26		P6_5			CLK1		
27		P6_4			CTS1/RTS1/CTS0/CLKS1		
28		P6_3			TXD0/SDA0		
29		P6_2			RXD0/SCL0		
30		P6_1			CLK0		
31		P6_0			CTS0/RTS0		
32		P5_7					CLKOUT
33		P5_6					
34		P5_5					
35		P5_4					
36		P5_3					
37		P5_2					
38		P5_1					
39		P5_0					
40		P4_3					
41		P4_2					
42		P4_1					
43		P4_0					
44		P3_7					
45		P3_6					
46		P3_5					
47		P3_4					
48		P3_3					
49		P3_2					
50		P3_1					