



Chipsmall Limited consists of a professional team with an average of over 10 year of expertise in the distribution of electronic components. Based in Hongkong, we have already established firm and mutual-benefit business relationships with customers from,Europe,America and south Asia,supplying obsolete and hard-to-find components to meet their specific needs.

With the principle of “Quality Parts,Customers Priority,Honest Operation,and Considerate Service”,our business mainly focus on the distribution of electronic components. Line cards we deal with include Microchip,ALPS,ROHM,Xilinx,Pulse,ON,Everlight and Freescale. Main products comprise IC,Modules,Potentiometer,IC Socket,Relay,Connector.Our parts cover such applications as commercial,industrial, and automotives areas.

We are looking forward to setting up business relationship with you and hope to provide you with the best service and solution. Let us make a better world for our industry!



Contact us

Tel: +86-755-8981 8866 Fax: +86-755-8427 6832

Email & Skype: info@chipsmall.com Web: www.chipsmall.com

Address: A1208, Overseas Decoration Building, #122 Zhenhua RD., Futian, Shenzhen, China



Customer Information Sheet

DRAWING No.: M80-4C10805F1-02-325-00-000

SHEET 2 OF 2

IF IN DOUBT - ASK

©

NOT TO SCALE

THIRD ANGLE PROJECTION

ALL DIMENSIONS IN mm

SPECIFICATIONS:

MATERIAL:

MOULDING: GLASS FILLED PPS, UL94V-0, BLACK

SIGNAL CONTACT:

CLIP = BERYLLIUM COPPER

SHELL = BRASS

POWER CONTACT:

BODY = COPPER ALLOY

LATCHING COLLAR = BERYLLIUM COPPER

JACKSCREW, CIRCLIP: STAINLESS STEEL

FINISH:

SIGNAL CONTACT:

CLIP = 0.3µ GOLD

SHELL = 0.25-0.3µ GOLD

POWER CONTACT:

BODY = GOLD

LATCHING COLLAR = NICKEL

ELECTRICAL:

WORKING VOLTAGE = 800V AC/DC

VOLTAGE PROOF = 1200V AC/DC

INSULATION RESISTANCE = 100MΩ MIN

SIGNAL CONTACT:

CURRENT RATING AT 25°C = 3.0A MAX

CURRENT RATING AT 85°C = 2.2A MAX

CONTACT RESISTANCE = 25 mΩ MAX

POWER CONTACT:

CONTACT RESISTANCE = 6 mΩ MAX

CURRENT RATING = 20A MAX WITH 12AWG

CONTACT AS SPECIFIED

MECHANICAL:

DURABILITY = 500 OPERATIONS

SIGNAL CONTACT:

INSERTION FORCE = 2.8N MAX

WITHDRAWAL FORCE = 0.2N MIN

POWER CONTACT:

INSERTION FORCE = 8N MAX

WITHDRAWAL FORCE = 0.5N MIN

ENVIRONMENTAL:

TEMPERATURE RANGE = -55°C TO +125°C

PACKING:

BAG

FOR COMPLETE SPECIFICATION SEE COMPONENT SPECIFICATION C005XX (LATEST ISSUE)

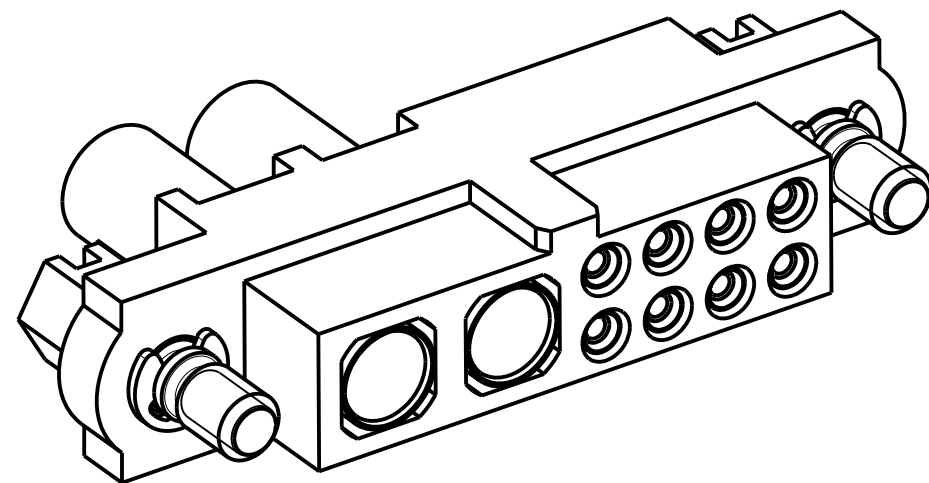
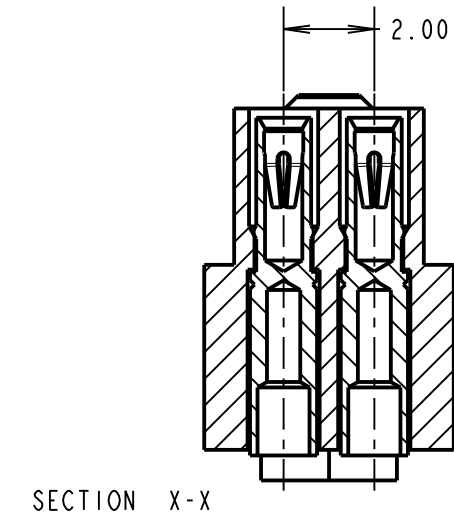
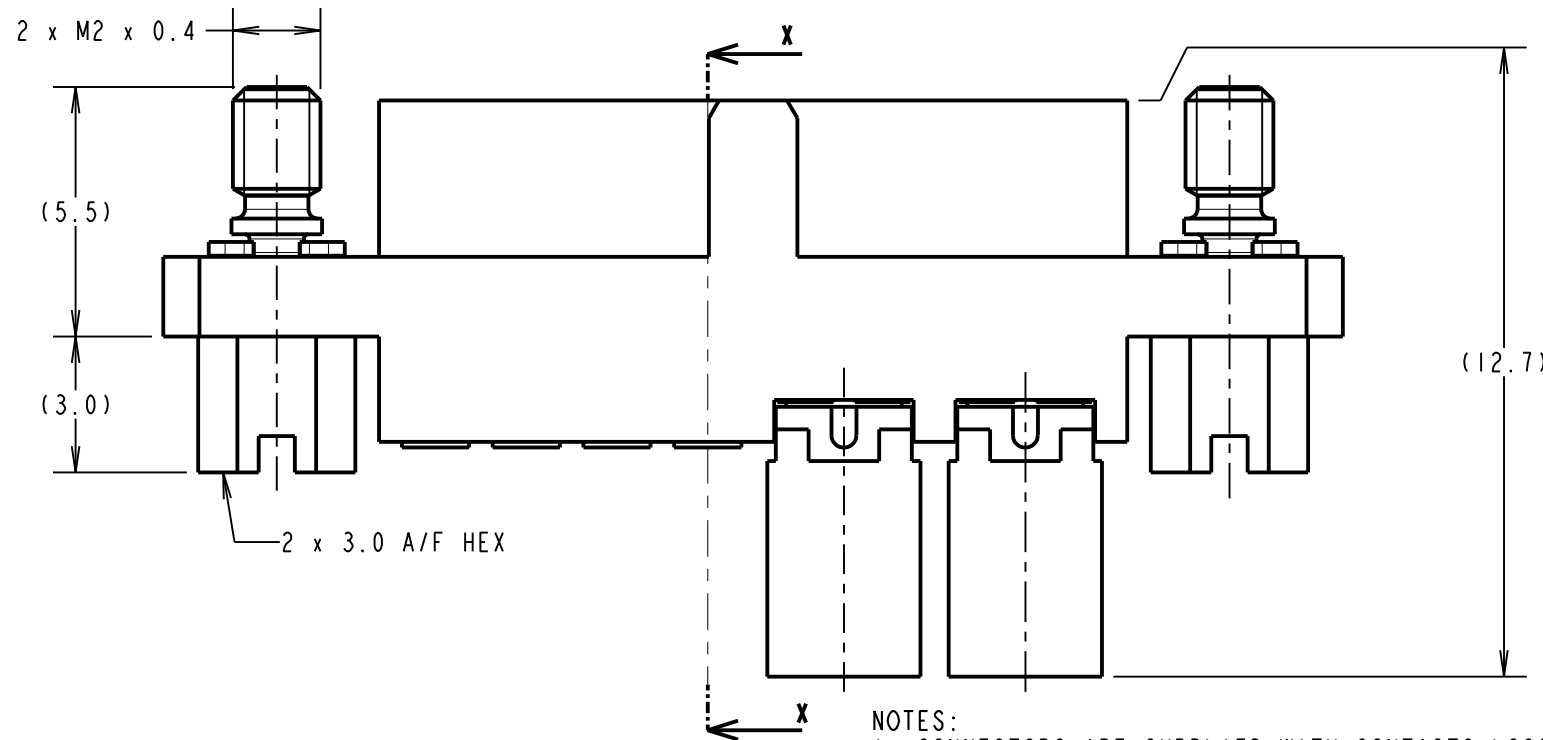
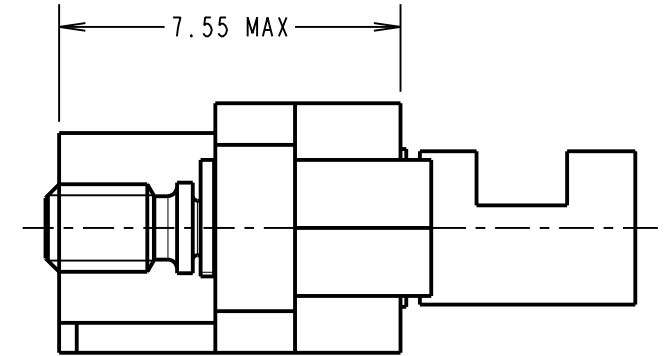
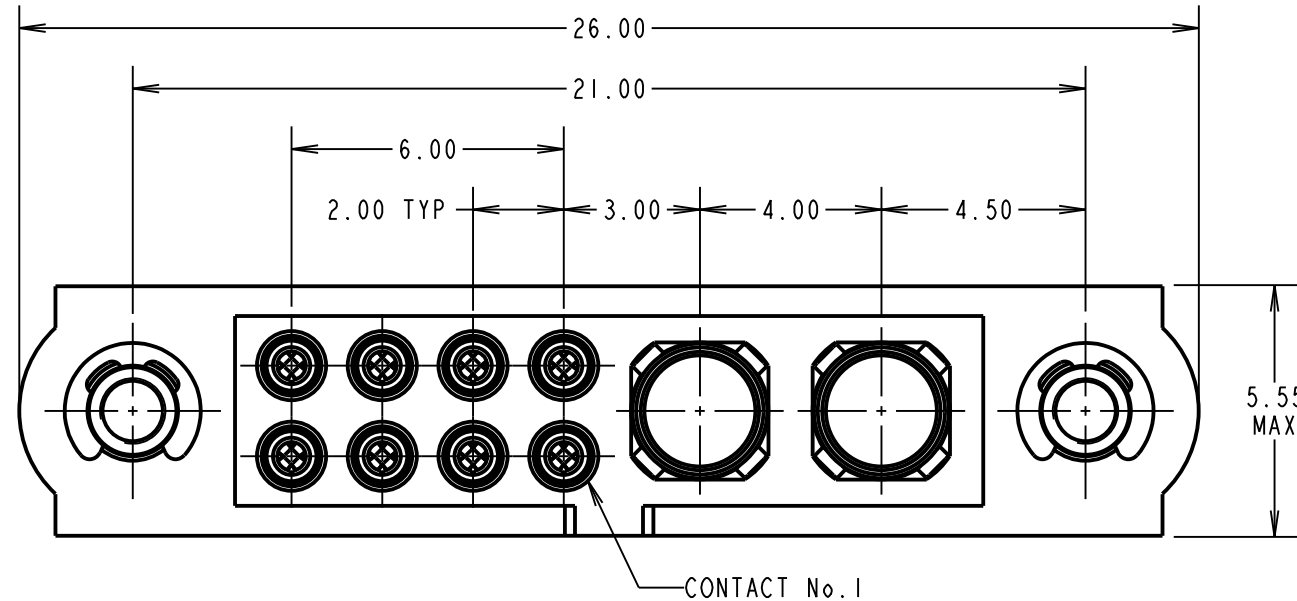

NOTES:

- CONNECTORS ARE SUPPLIED WITH CONTACTS LOOSE.
- FOR EXTRA SIGNAL CONTACTS, USE PART NUMBER M80-0130005.
- RECOMMENDED SIGNAL WIRE TYPE = BS 3G 210 TYPE A, PTFE INSULATED 24-28 AWG. MAX INSULATION DIAMETER = Ø1.10mm. STRIP WIRE BY 2.00mm FOR CRIMPING.
- RECOMMENDED HAND CRIMP TOOL FOR SIGNAL CONTACTS = M22520/2-01 WITH POSITIONER T5747. REFER TO TOOLING INSTRUCTION SHEET IS-01 FOR COMPLETE CRIMPING INSTRUCTIONS.
- SIGNAL CONTACT INSERTION AND EXTRACTION TOOL = Z80-280. REFER TO TOOLING INSTRUCTION SHEET IS-25 FOR ASSEMBLY INSTRUCTIONS.
- FOR EXTRA POWER CONTACTS, USE PART NUMBER M80-325.
- POWER CONTACT WIRE, STRIP BY 5.00mm MINIMUM.
- POWER CONTACT EXTRACTION TOOL = Z80-290.
- INSTRUCTION SHEETS ARE AVAILABLE.

MGP	2	11.01.13	11898
NAME	ISS.	DATE	C/NOTE
APPROVED: MGP			
CHECKED: SB			
DRAWN: R.ADDE			
CUSTOMER REF.:			
ASSEMBLY DRG:			

HARWIN

www.harwin.com
technical@harwin.com

THIS DRAWING AND ANY INFORMATION OR DESCRIPTIVE MATTER SET OUT HEREON ARE CONFIDENTIAL AND COPYRIGHT PROPERTY OF THE HARWIN GROUP AND MUST NOT BE DISCLOSED, LOANED, COPIED OR USED FOR MANUFACTURING, TENDERING OR FOR ANY OTHER PURPOSE WITHOUT THEIR WRITTEN PERMISSION.

TOLERANCES

X. = ±1mm
X.X = ±0.25mm
X.XX = ±0.10mm
X.XXX = ±0.01mm
ANGLES = ±5°
UNLESS STATED

MATERIAL:

SEE ABOVE

FINISH:

SEE ABOVE

S/AREA:

mm²

TITLE:

DATAMATE MIX-TEK
FEMALE ASSEMBLY
WITH JACKSCREW

DRAWING NUMBER:

M80-4C10805F1-02-325-00-000

SHT
2 OF 2