



Chipsmall Limited consists of a professional team with an average of over 10 year of expertise in the distribution of electronic components. Based in Hongkong, we have already established firm and mutual-benefit business relationships with customers from,Europe,America and south Asia,supplying obsolete and hard-to-find components to meet their specific needs.

With the principle of “Quality Parts,Customers Priority,Honest Operation,and Considerate Service”,our business mainly focus on the distribution of electronic components. Line cards we deal with include Microchip,ALPS,ROHM,Xilinx,Pulse,ON,Everlight and Freescale. Main products comprise IC,Modules,Potentiometer,IC Socket,Relay,Connector.Our parts cover such applications as commercial,industrial, and automotives areas.

We are looking forward to setting up business relationship with you and hope to provide you with the best service and solution. Let us make a better world for our industry!



Contact us

Tel: +86-755-8981 8866 Fax: +86-755-8427 6832

Email & Skype: info@chipsmall.com Web: www.chipsmall.com

Address: A1208, Overseas Decoration Building, #122 Zhenhua RD., Futian, Shenzhen, China





MA104.C.W.AB.002
on ground-plane

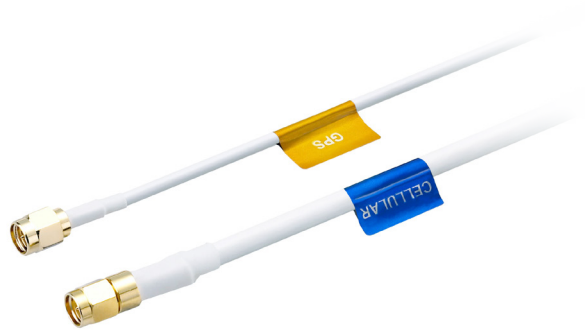

Hercules

MA104.C.W.AB.002

Specification

Part No.	MA104.C.W.AB.002
Product Name	Hercules MA104 2in1 Combination Hercules GPS/Cellular Screw Mount (Permanent Mount)
Feature	<p>Low profile - Height 28.5mm and Diameter 47.8mm</p> <p>Heavy Duty Screw Mount</p> <p>White PC Casing</p> <p>GPS - Two Stage 28dB+ LNA</p> <p>Cellular - Penta Band Antenna 850/900/1800/1900/2100/1575.42 MHz</p> <p>GSM/GPRS/CDMA/EVDO/UMTS/HSPA/WCDMA</p> <p>IP67 compliance</p> <p>Standard is 3 metres SMA(M) GPS:RG174 / Cellular:CFD200</p> <p>Cables and connectors are fully customizable</p> <p>White Version</p> <p>ROHS Compliant</p>



1. Introduction

The MA104.C.W GPS & Cellular 2in1 Combination Hercules Antenna is a combination high performance GPS and penta-band cellular antenna solution for reliable asset tracking and remote monitoring. Durable UV and robust PC housing is resistant to vandalism and direct attack. At only 29 mm height it complies with the latest EU height restrictions directives for roof-mounted objects, with a diameter of 49 mm. It is designed to not catch on tree-branches.

The Hercules can be mounted on metal or non-metal structures as it has a metal ground-plane base integrated inside. The MA104 is also available in Black.

2. Specification

ELECTRICAL CELLULAR						
Standard	AMPS	GSM	DCS	PCS	3G	
Band (MHz)	850	900	1800	1900	2100	
Frequency (MHz)	824 ~ 896	880 ~ 960	1710 ~ 1880	1850 ~ 1990	1920 ~ 2170	
Return Loss (dB)						
Cable Length	0.3m	-6.5	-6.0	-8	-7	-5
	1.0m	-9.5	-8	-16	-17	-15
	2.0m	-10	-9	-21	-20	-18
	3.0m	-13	-11	-21	-21	-19
	5.0m	-14	-14	-25	-25	-23
Efficiency (%)						
Cable Length	0.3m	38	MECHANICAL	54	58	50
	1.0m	31	35	42	36	31
	2.0m	23	20	32	23	21
	3.0m	25	29	22	23	18
	5.0m	11	11.5	11	12	11
Peak Gain (dB)						
Cable Length	0.3m	2.0	3.3	3.6	4.0	3.0
	1.0m	1.2	1.3	1.8	2	1.2
	2.0m	0.5	-0.35	1.5	0	-0.1
	3.0m	0.1	1.6	0.1	0.6	-0.9
	5.0m	-2.5	-2.4	-3.0	-2.3	-2.0
Polarization			Linear			
Impedance (Ohms)			50 Ohms			
Input Power			10 Watts max.			
VSWR			<3.5:1			

2. Specifications

ELECTRICAL GPS			
Frequency	1575.42MHz ± 1.023MHz		
Impedance	50 ohm		
VSWR	2.0 Max		
GPS Patch Gain	-2.0dB Passive Gain @ Zenith -1.0dBi Gain @ 10 degrees elevation		
Axial ratio	3.0 dB max		
Polarization	RHCP		
Out Band Rejection	fo = 1575.42MHz fo ± 30 MHz 5dB Min. fo ± 50 MHz 20dB Min. fo ± 100 MHz 25dB Min.		
Input Voltage	Min:1.8V	Typ. 3.0V	Max: 5.5V
Total Gain @ Zenith	25dBic	30dBic	32dBic
Current Consumption	6mA	12mA	30mA
Noise Figure	2.7dB	3.0dB	3.7dB

MECHANICAL	
Dimensions	Height 28.5mm x Diameter 47.8mm
Casing	White PC
Base and thread	Nickel plated steel
Thread diameter	18mm
Weather proof gasket	DP-3060W foam with 3M9448HK double-side adhesive
Cable pull	8 Kgf
Recommended Mounting Torque	24.5N-m
Maximum Mounting Torque	29.4N-m

ENVIRONMENTAL	
Waterproof	IP-67 & IP-69K
Corrosion	5% NaCl for 96hrs - Nickel plated steel base and thread
Temperature Range	-40°C to +85°C
Thermal Shock	100 cycles -40°C to +85°C
Humidity	Non-condensing 65°C 95% RH
Shock (Drop Test)	1m drop on concrete 6 axes

***Note:** The return loss, efficiency and gain measurements in the above table, were taken for the antenna mounted on a 30x30 cm metal plate. For a specific case performance refers to the below plots.

3. Test Set Up

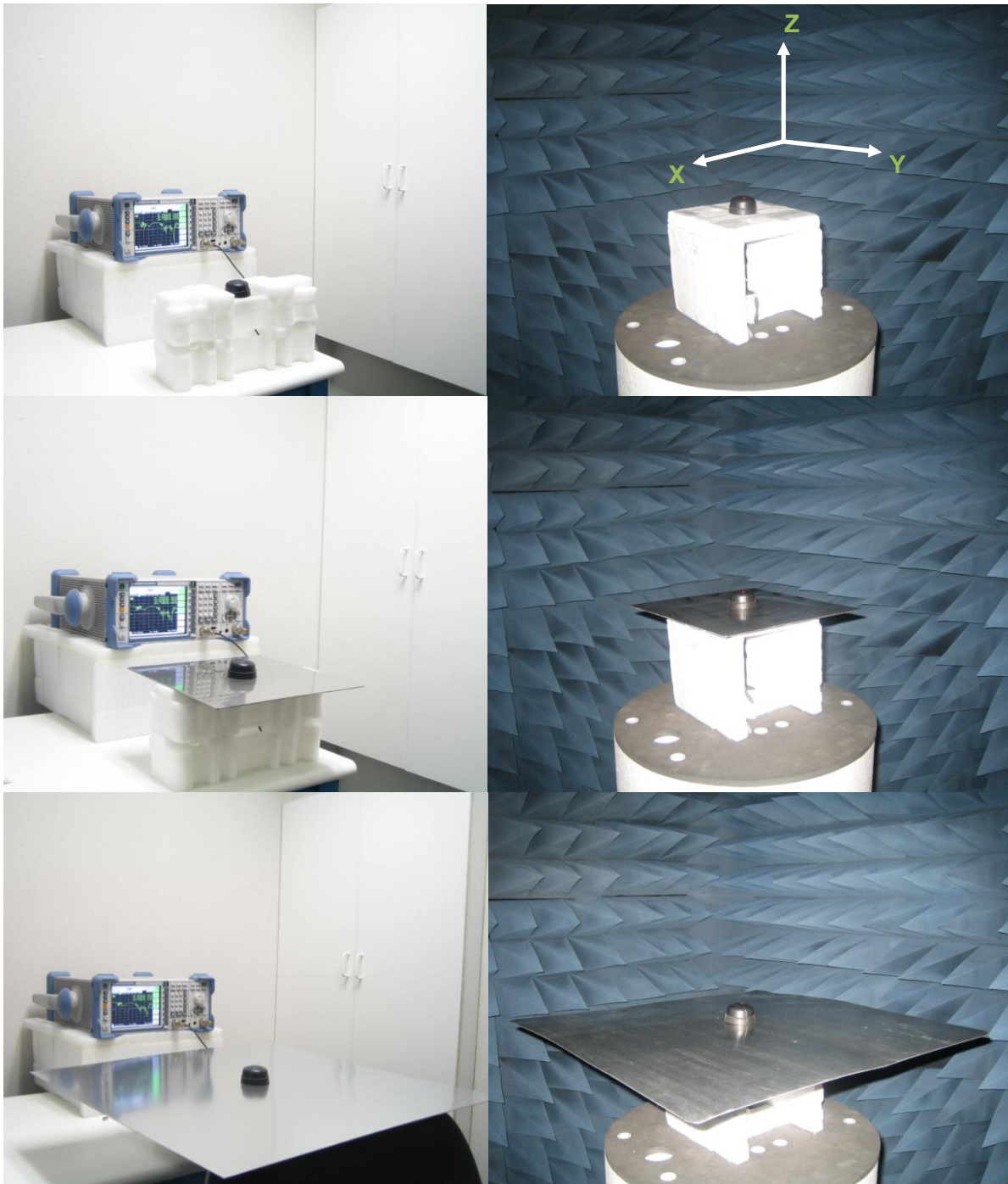

Figure 1. MA104 Antenna test set up in free space, 30x30 cm metal plate and 60x60 cm metal plate, R&SZVL6 VNA (Left) and R&S4100 CTIA 3D Chamber (Right).

4. Cellular Antenna Parameters

4.1 Return Loss

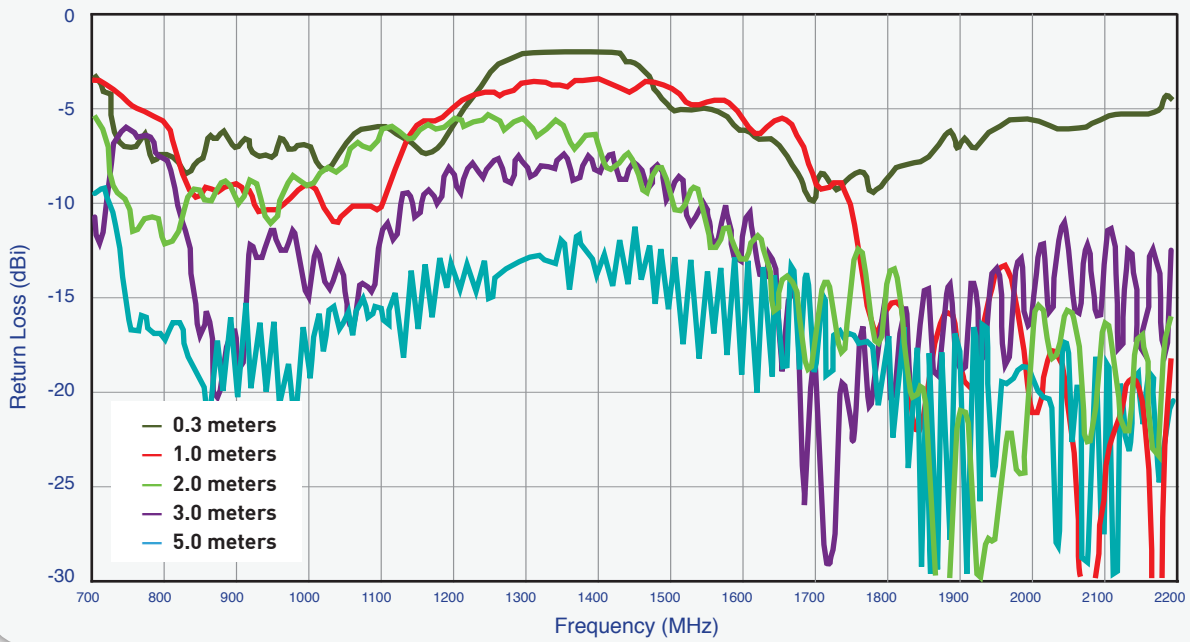

Figure 2. Return Loss of the MA104 antenna in free space

4.1 Return Loss

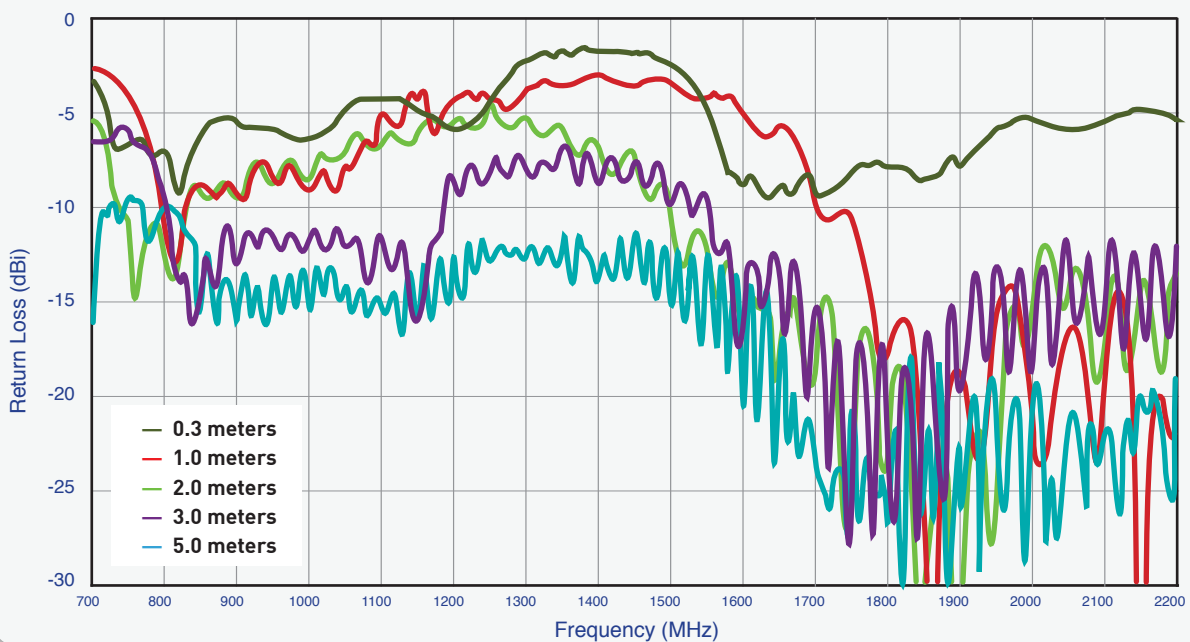

Figure 3. Return Loss of the MA104 antenna on 30*30cm metal plate

4.1 Return Loss

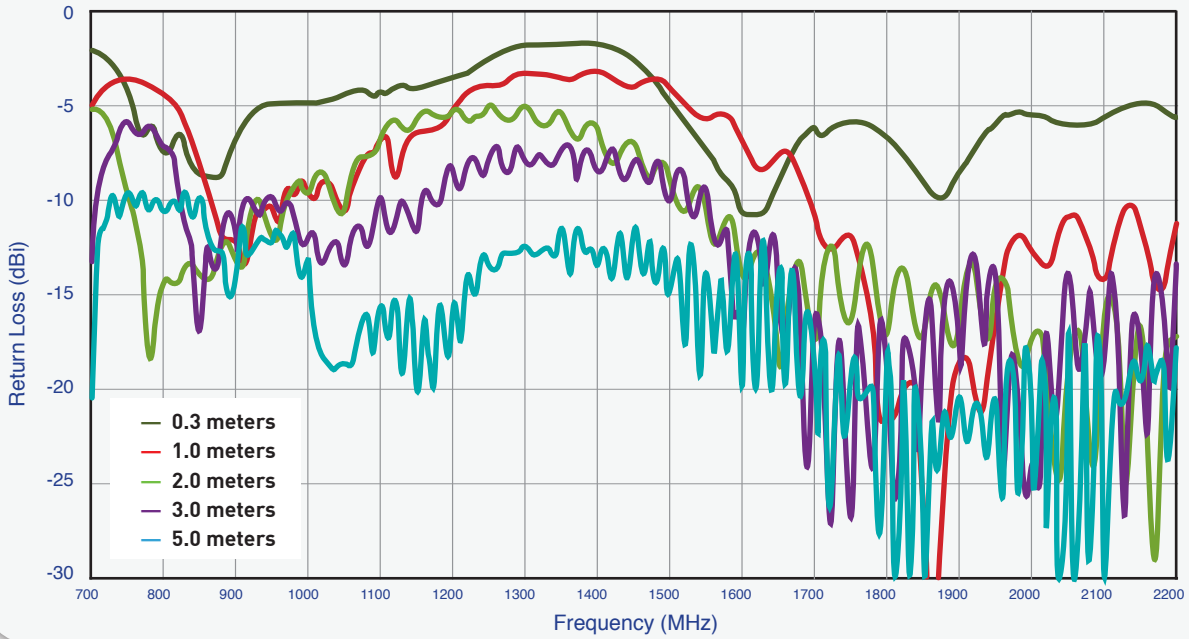

Figure 4. Return Loss of the MA104 antenna on 60*60cm metal plate.

4.2 Efficiency

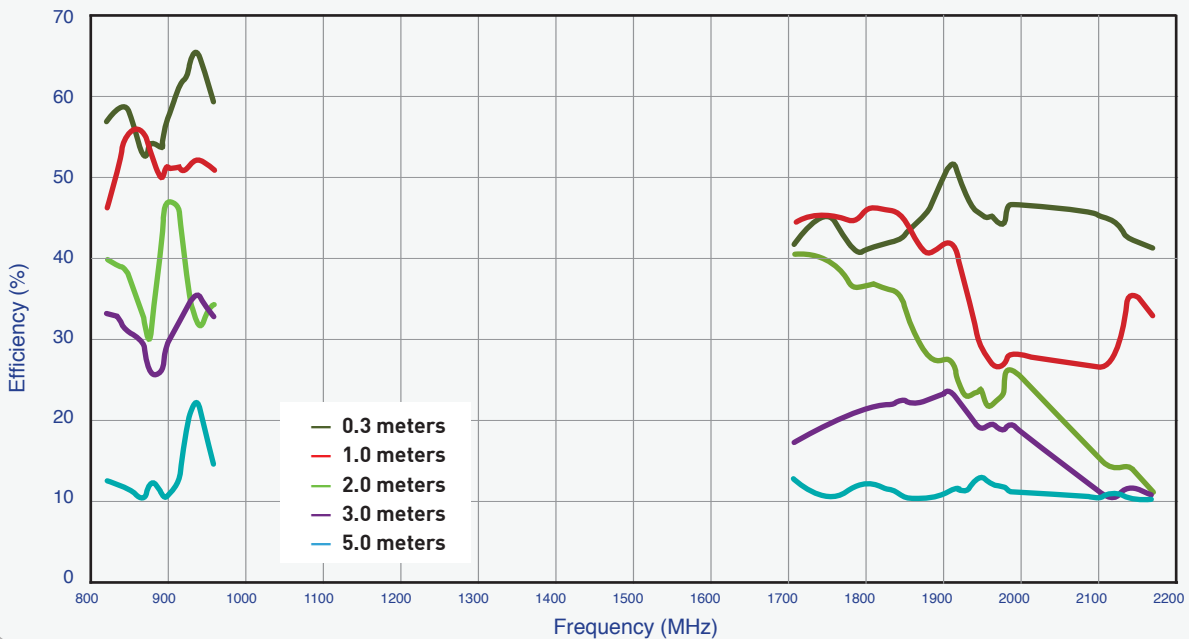

Figure 5. Efficiency of the MA104 antenna in free space.

4.2 Efficiency

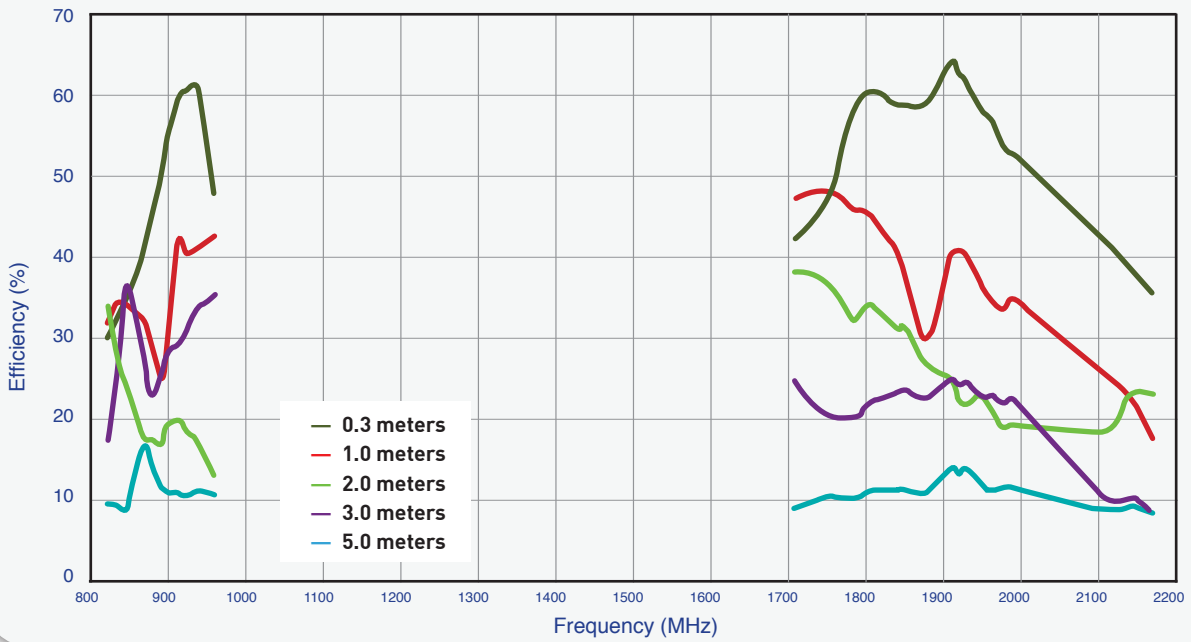

Figure 6. Efficiency of the MA104 antenna on 30*30cm metal plate.

4.2 Efficiency

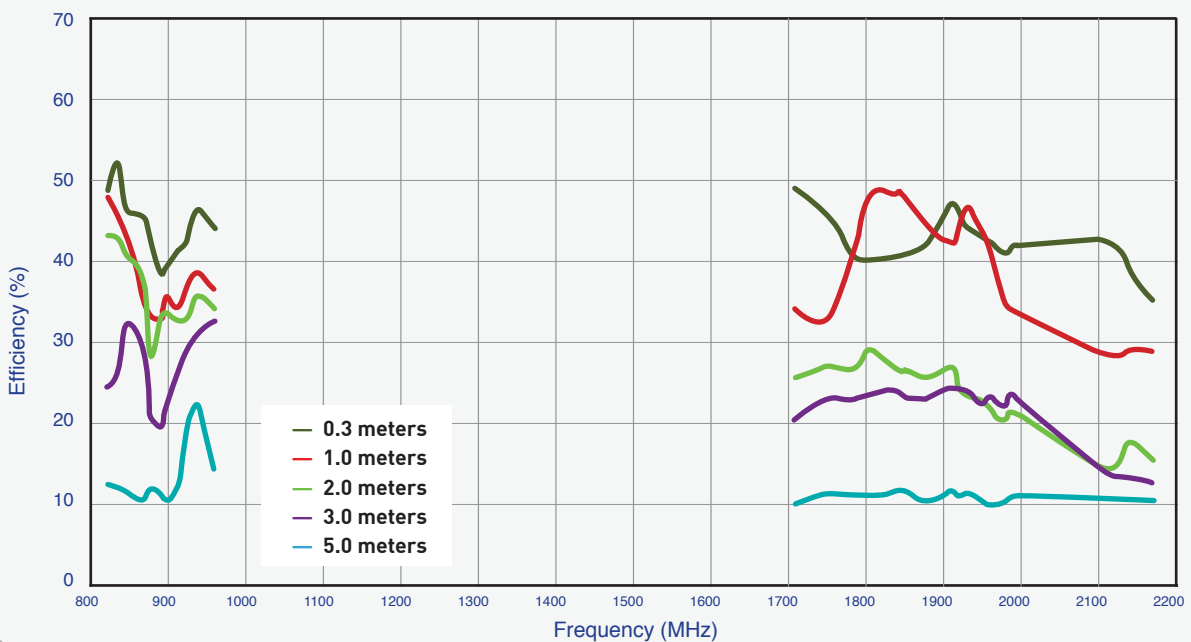

Figure 7. Efficiency of the MA104 antenna on 60*60cm metal plate.

4.3 Peak Gain

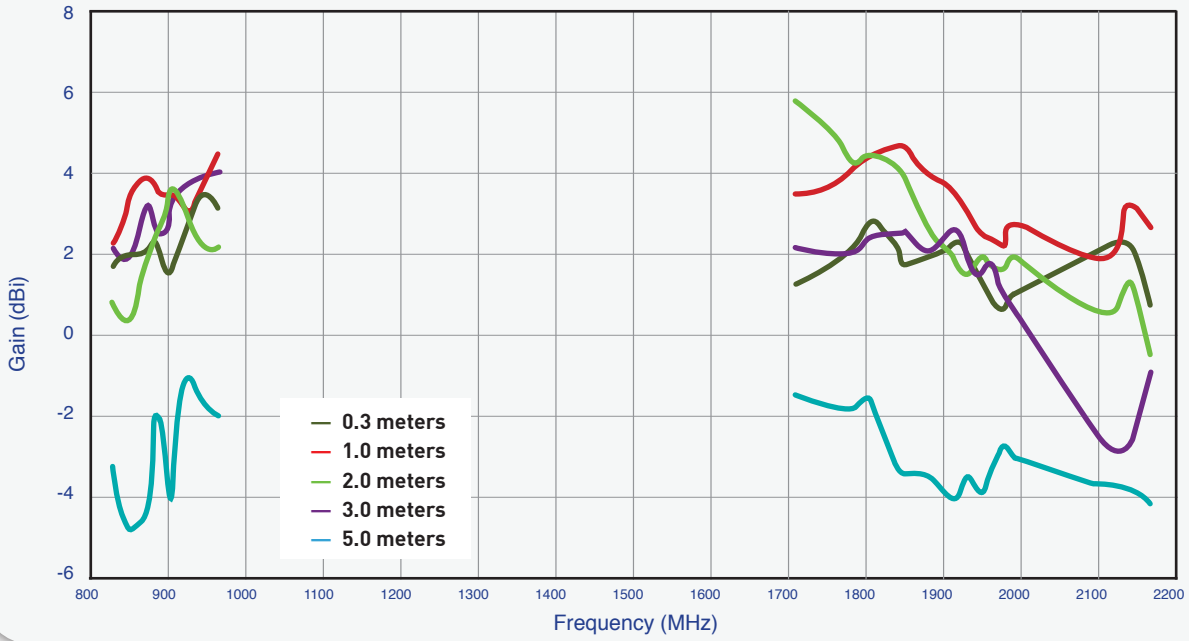

Figure 8. Gain of the MA104 antenna in free space

4.3 Peak Gain

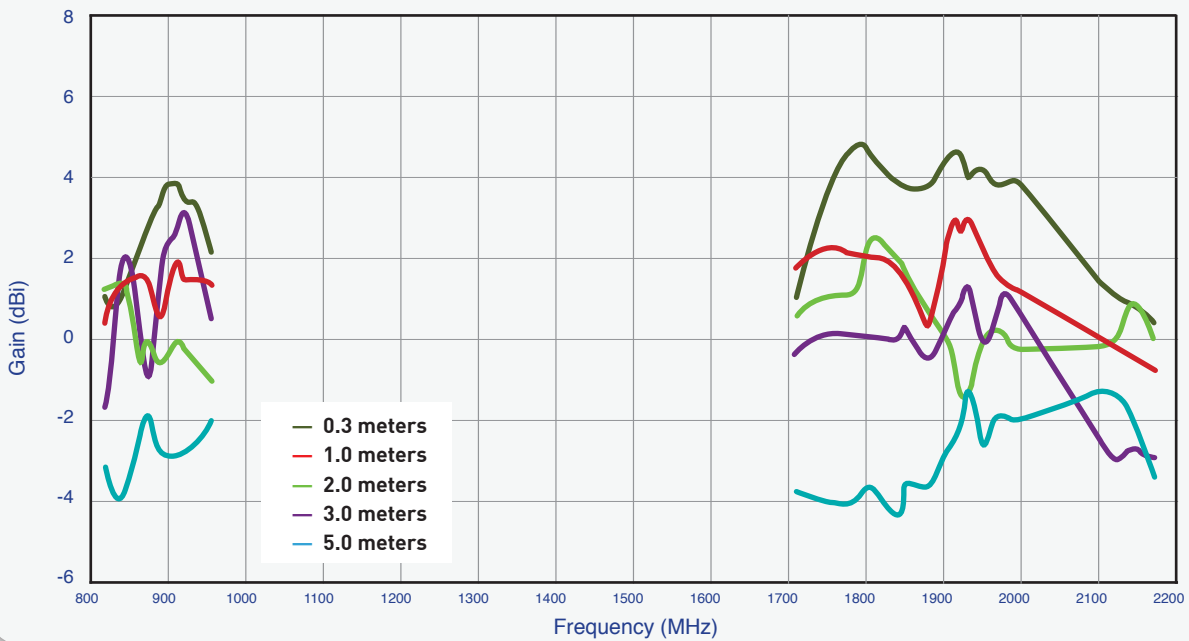

Figure 9. Gain of the MA104 antenna on 30*30cm metal plate

4.3 Peak Gain

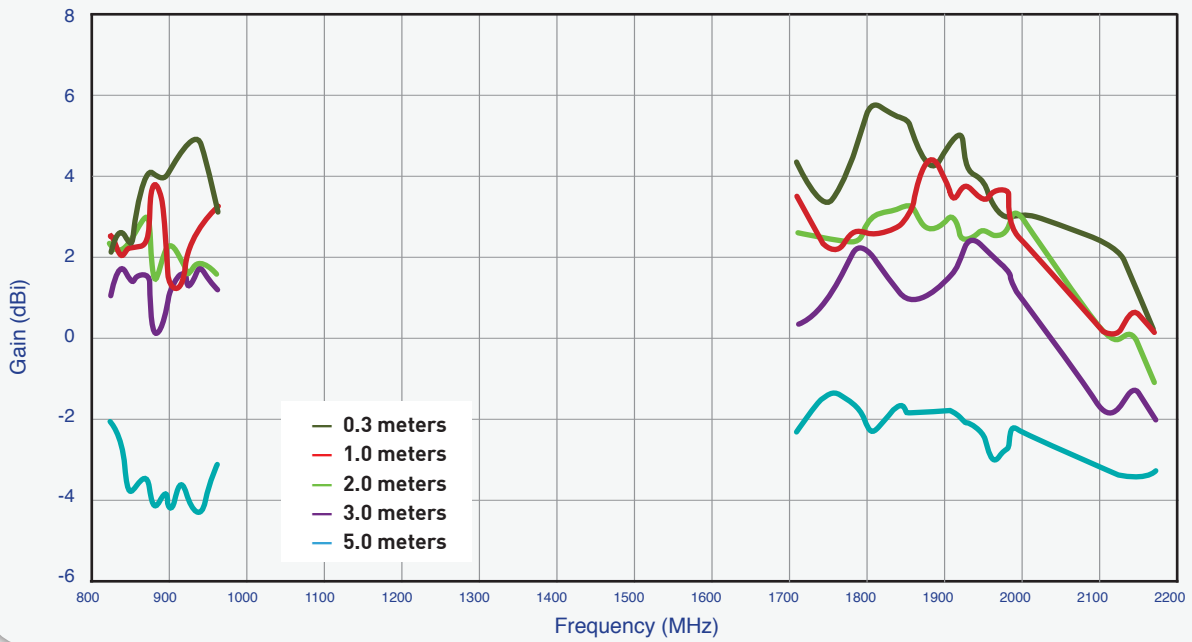

Figure 10. Gain of the MA105 antenna on 60*60cm metal plate

4.4 Radiation pattern

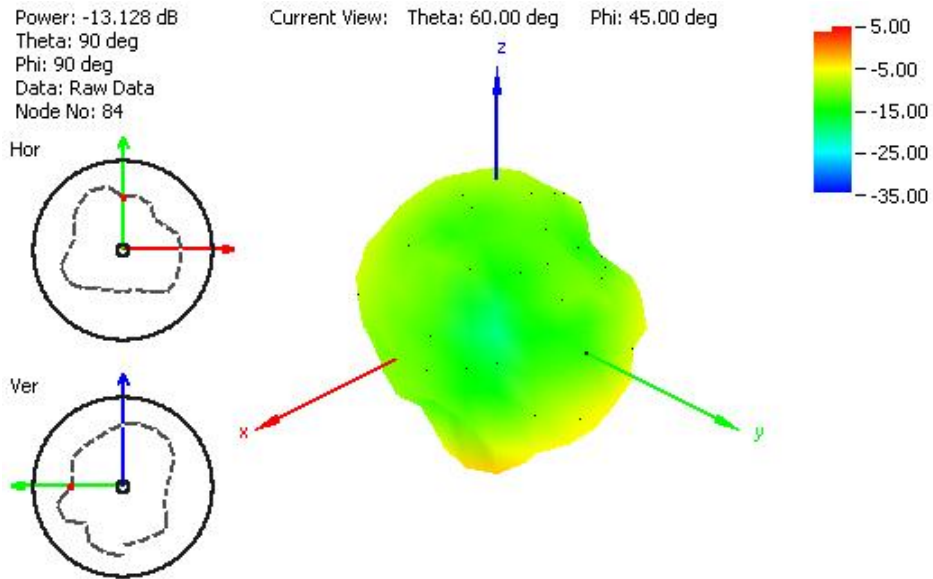

Figure 11. Radiation pattern at 849 MHz, Figure 1 as reference (dB), with 2 meter RG174 cable and free space

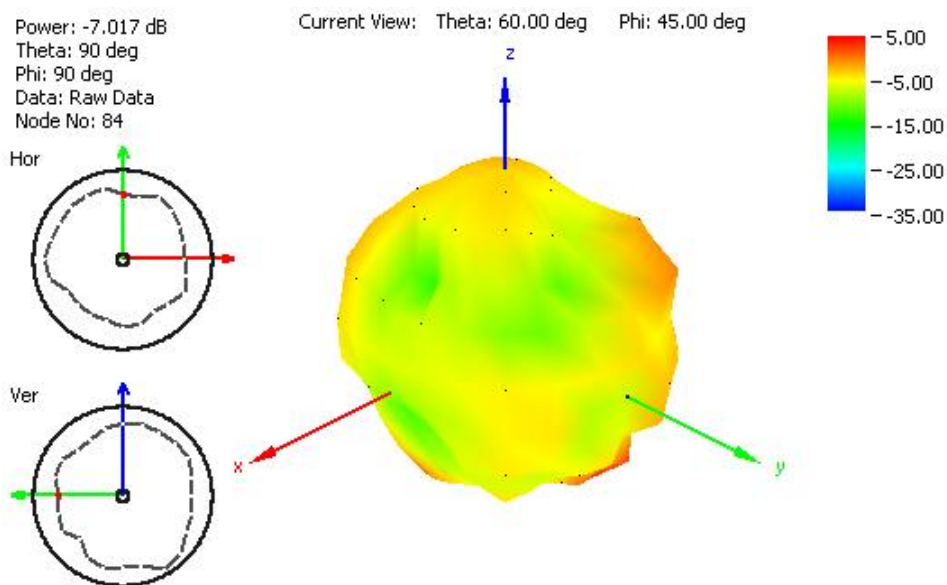

Figure 12. Radiation pattern at 915 MHz, Figure 1 as reference (dB), with 2 meter RG174 cable and free space

4.4 Radiation pattern

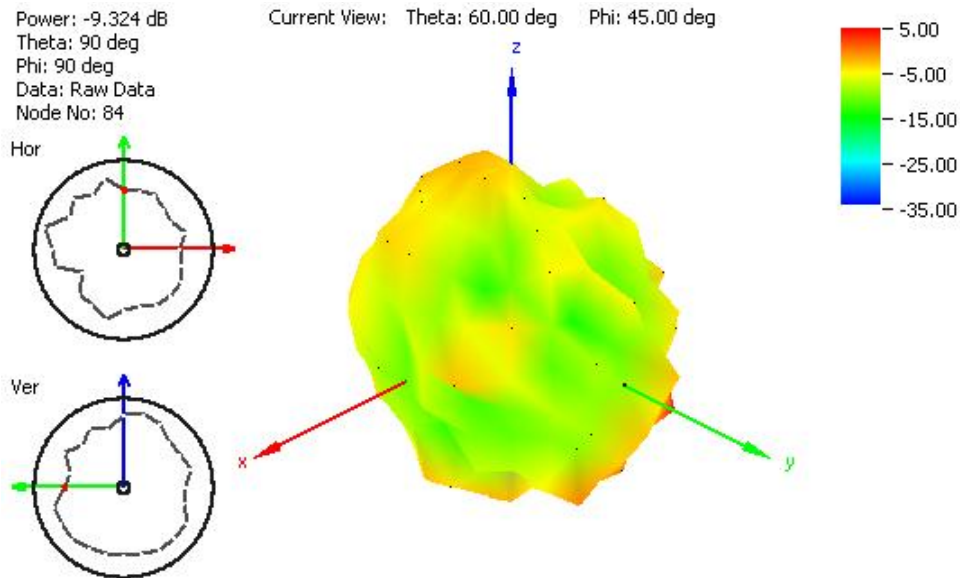

Figure 13. Radiation pattern at 1805 MHz, Figure 1 as reference (dB), with 2 meter RG174 cable and free space

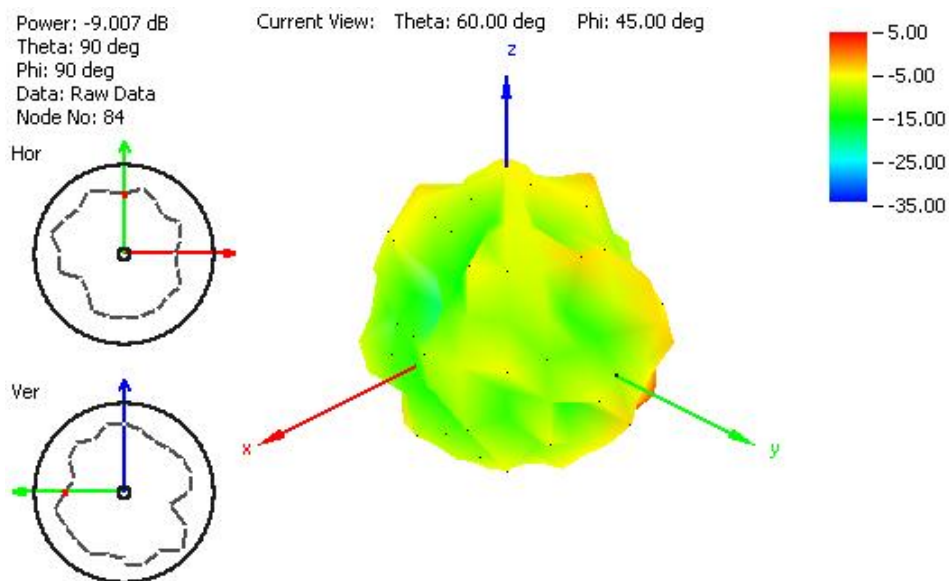

Figure 14. Radiation pattern at 1910 MHz, Figure 1 as reference (dB), with 2 meter RG174 cable and free space

4.4 Radiation pattern

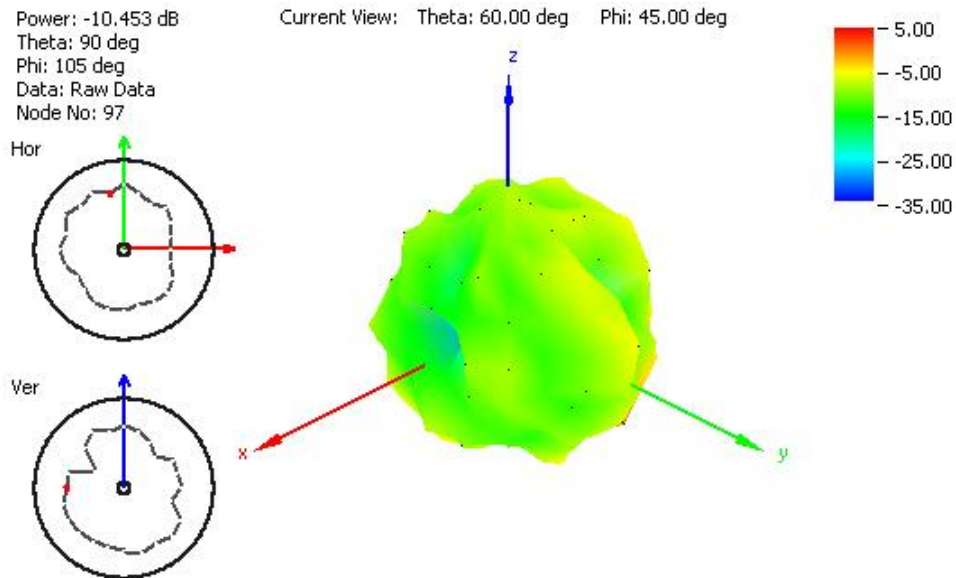

Figure 15. Radiation pattern at 2110 MHz, Figure 1 as reference (dB), with 2 meter RG174 cable and free space.

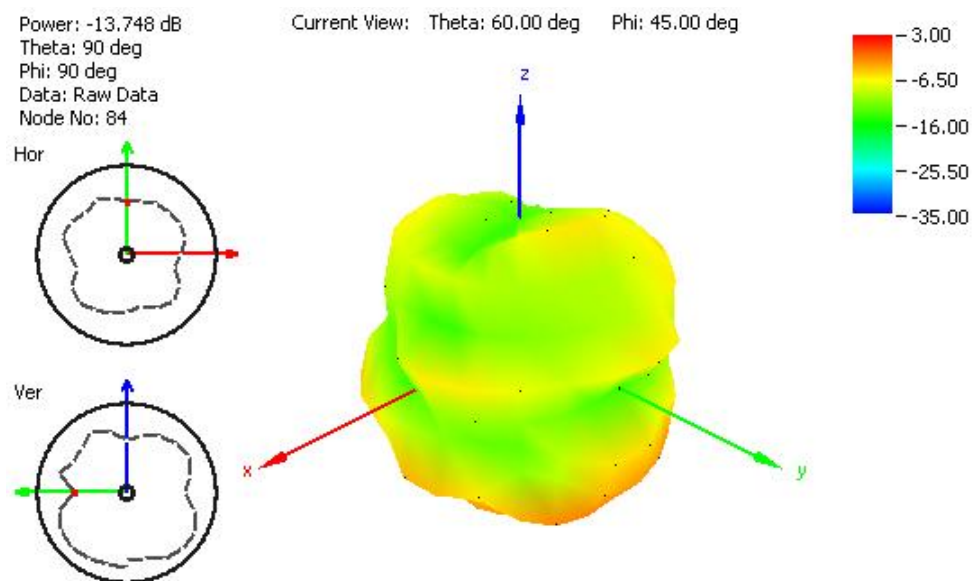

Figure 16. Radiation pattern at 849 MHz, Figure 1 as reference (dB), with 2 meter RG174 cable and 30x30 cm metal plate

4.4 Radiation pattern

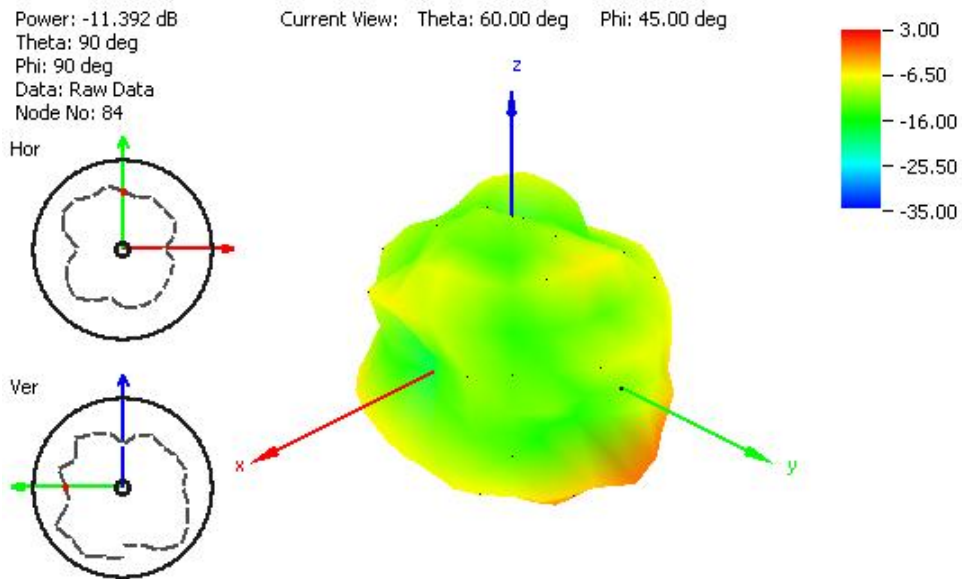

Figure 17. Radiation pattern at 915 MHz, Figure 1 as reference (dB), with 2 meter RG174 cable and 30x30 cm metal plate

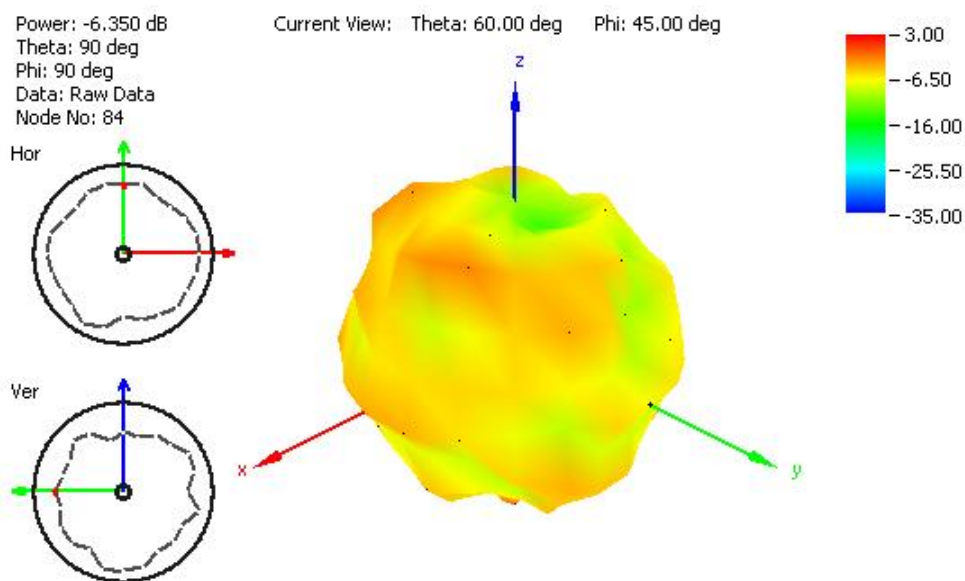

Figure 18. Radiation pattern at 1805 MHz, Figure 1 as reference (dB), with 2 meter RG174 cable and 30x30 cm metal plate

4.4 Radiation pattern

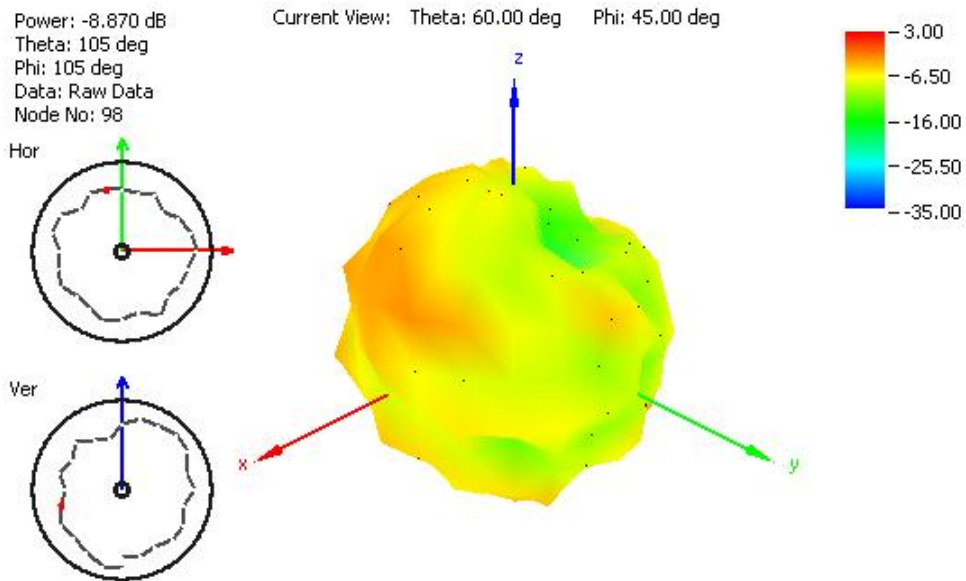

Figure 19. Radiation pattern at 1910 MHz, Figure 1 as reference (dB), with 2 meter RG174 cable and 30x30 cm metal plate

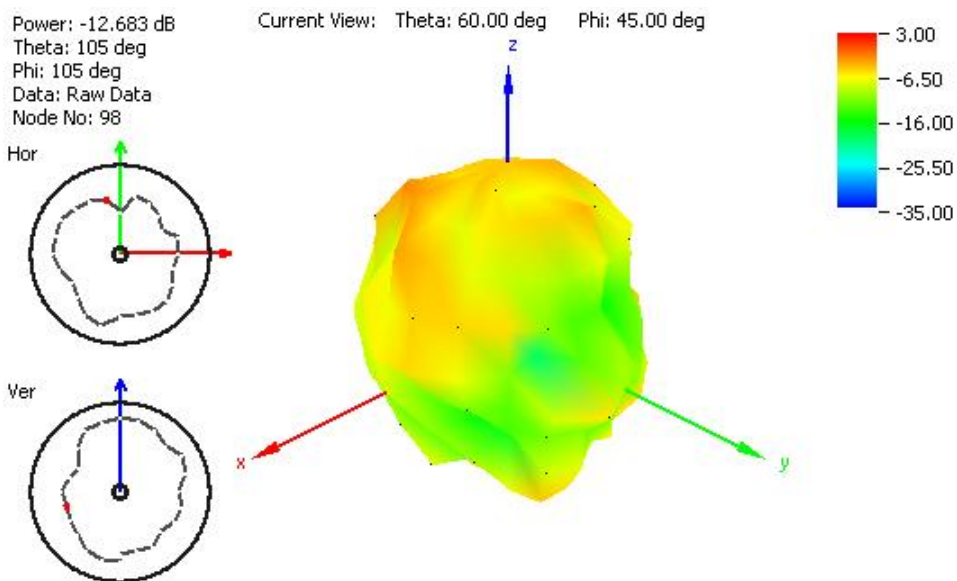

Figure 20. Radiation pattern at 2110 MHz, Figure 1 as reference (dB), with 2 meter RG174 cable and 30x30 cm metal plate

4.4 Radiation pattern

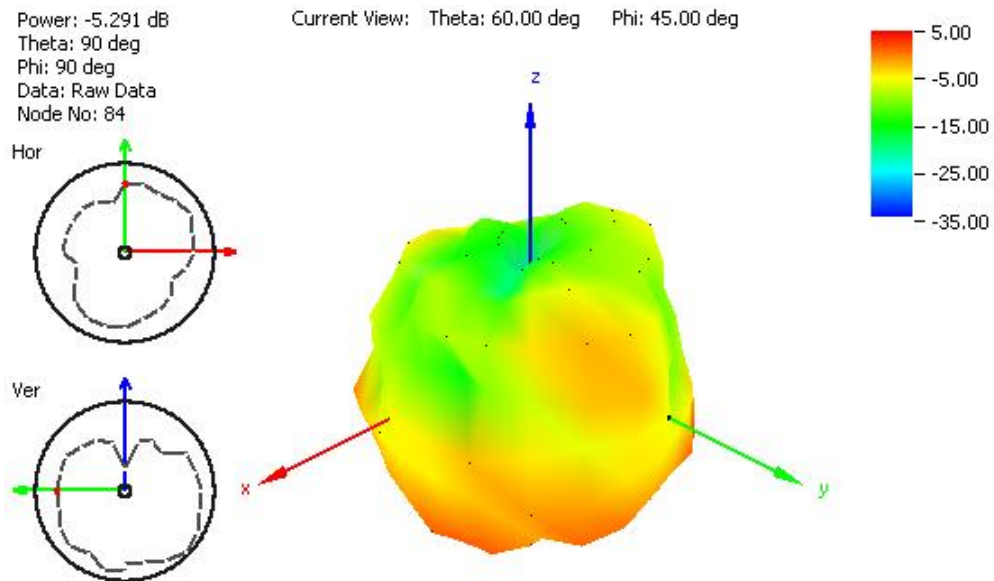

Figure 21. Radiation pattern at 849 MHz, Figure 1 as reference (dB), with 2 meter RG174 cable and 60x60 cm metal plate

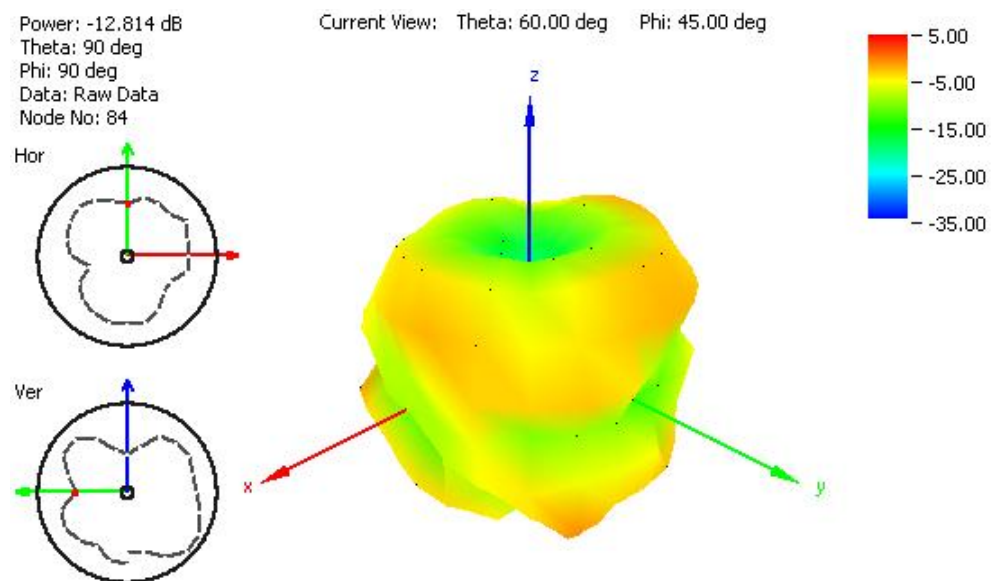

Figure 22. Radiation pattern at 915 MHz, Figure 1 as reference (dB), with 2 meter RG174 cable and 60x60 cm metal plate

4.4 Radiation pattern

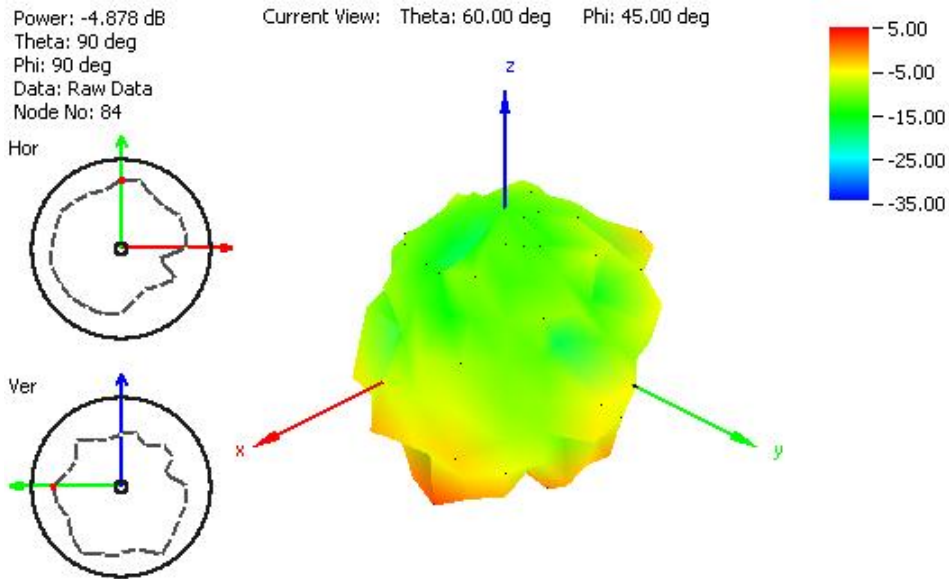

Figure 23. Radiation pattern at 1805 MHz, Figure 1 as reference (dB), with 2 meter RG174 cable and 60x60 cm metal plate

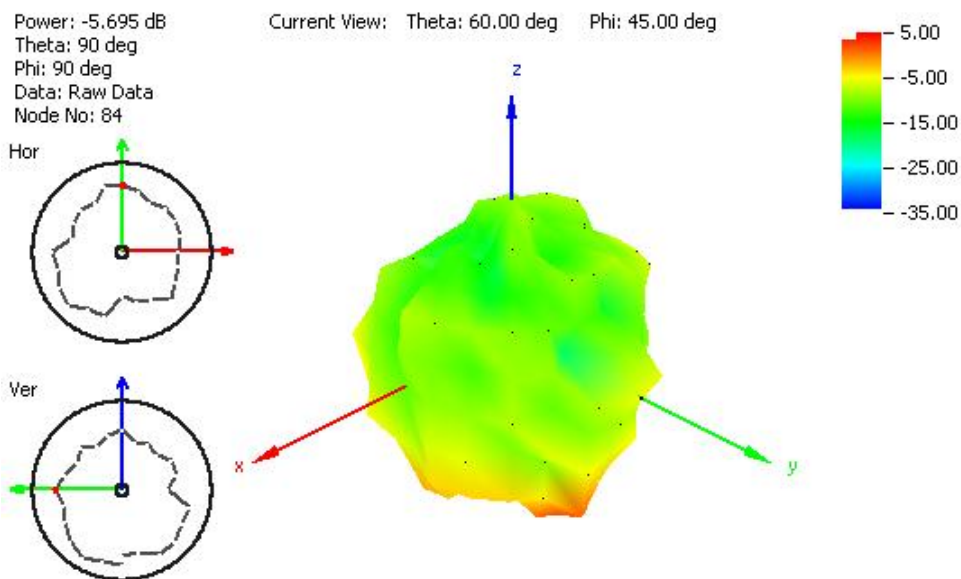

Figure 24. Radiation pattern at 1910 MHz, Figure 1 as reference (dB), with 2 meter RG174 cable and 60x60 cm metal plate

4.4 Radiation pattern

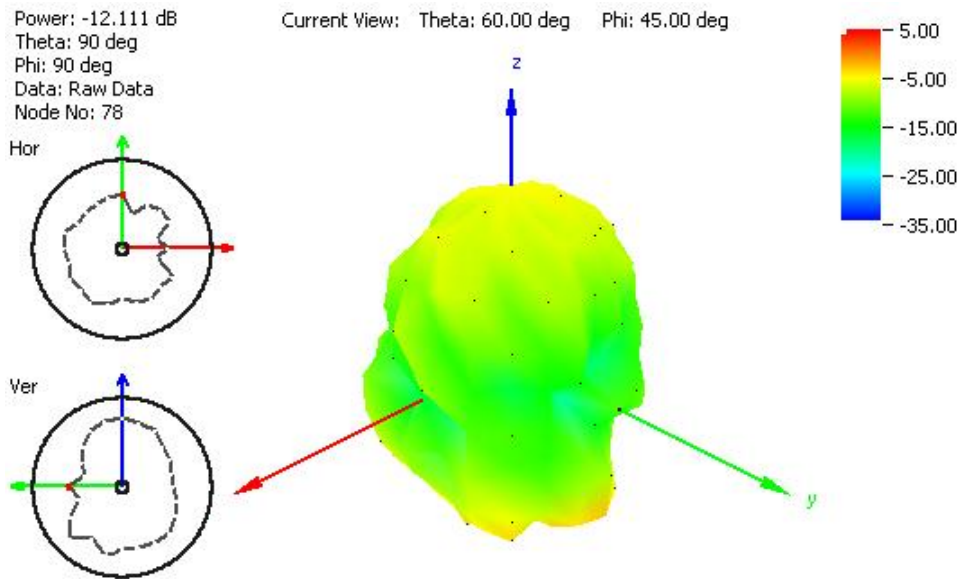
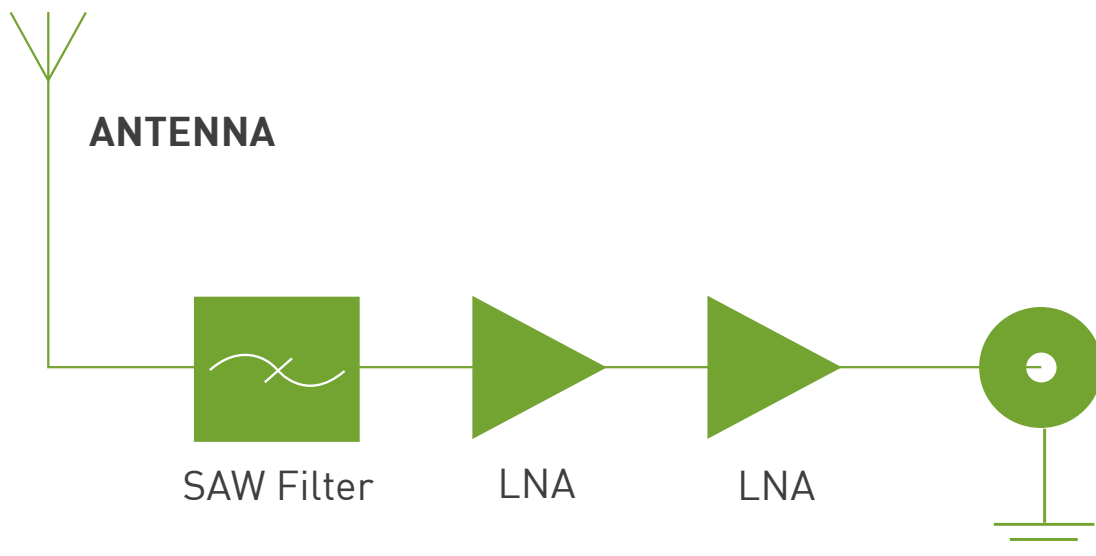
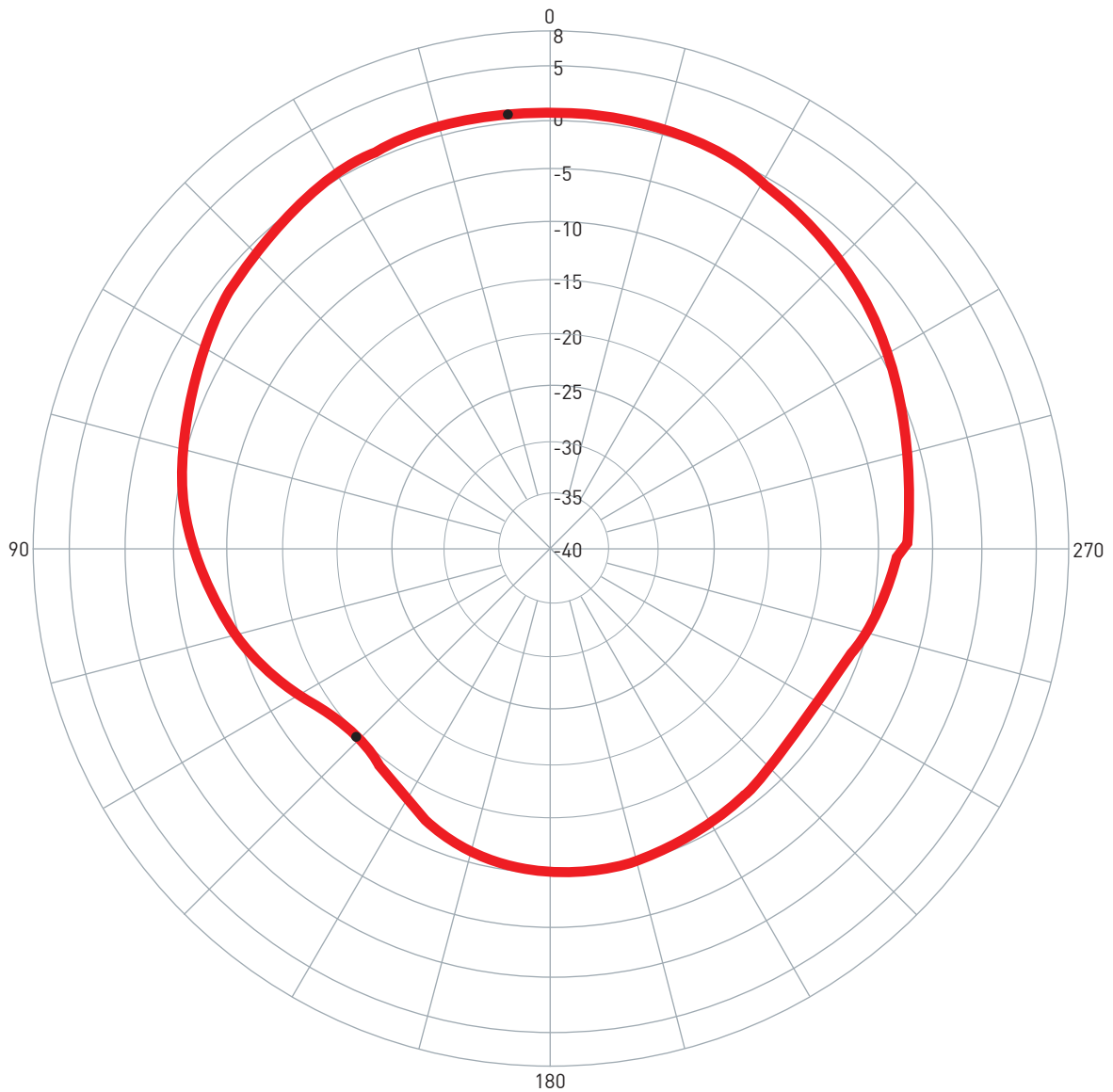

Figure 25. Radiation pattern at 2110 MHz, Figure 1 as reference (dB), with 2 meter RG174 cable and 60x60 cm metal plate

5. System Block Diagram



6. GPS Patch Radiation Pattern



0 degree is the top of Hercules.

7. LNA Properties

7.1 LNA Gain and Out-band Rejection @ 3.0V

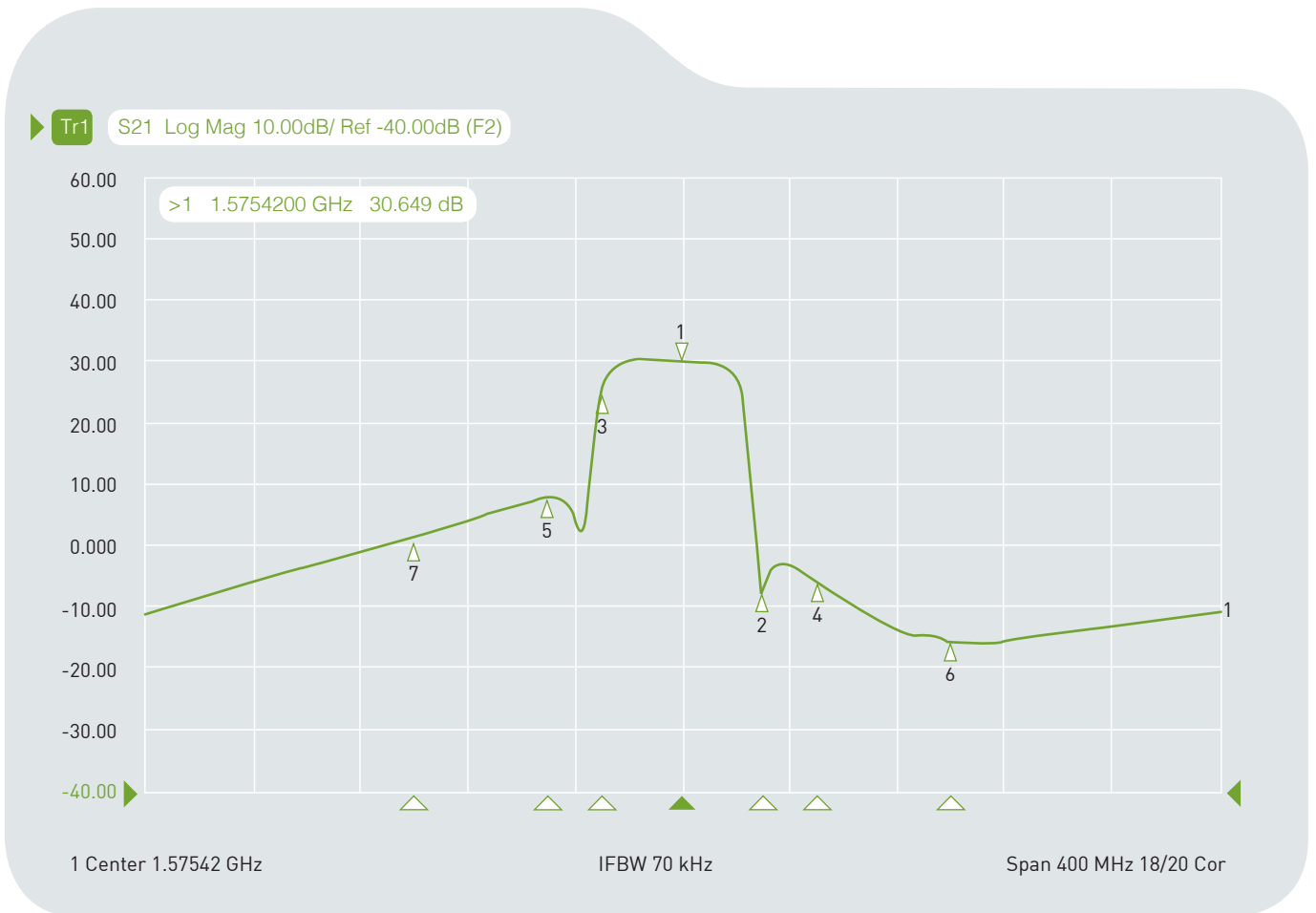

Cg1	Tr1	S21	>1	1.5754200 GHz	30.649	dB
Cg1	Tr1	S21	2	1.6054200 GHz	-6.7098	dB
Cg1	Tr1	S21	3	1.5454200 GHz	24.584	dB
Cg1	Tr1	S21	4	1.6254200 GHz	-5.6354	dB
Cg1	Tr1	S21	5	1.5254200 GHz	8.0734	dB
Cg1	Tr1	S21	6	1.6754200 GHz	-15.436	dB
Cg1	Tr1	S21	7	1.4754200 GHz	-1.5714	dB

7.2 Noise Figure

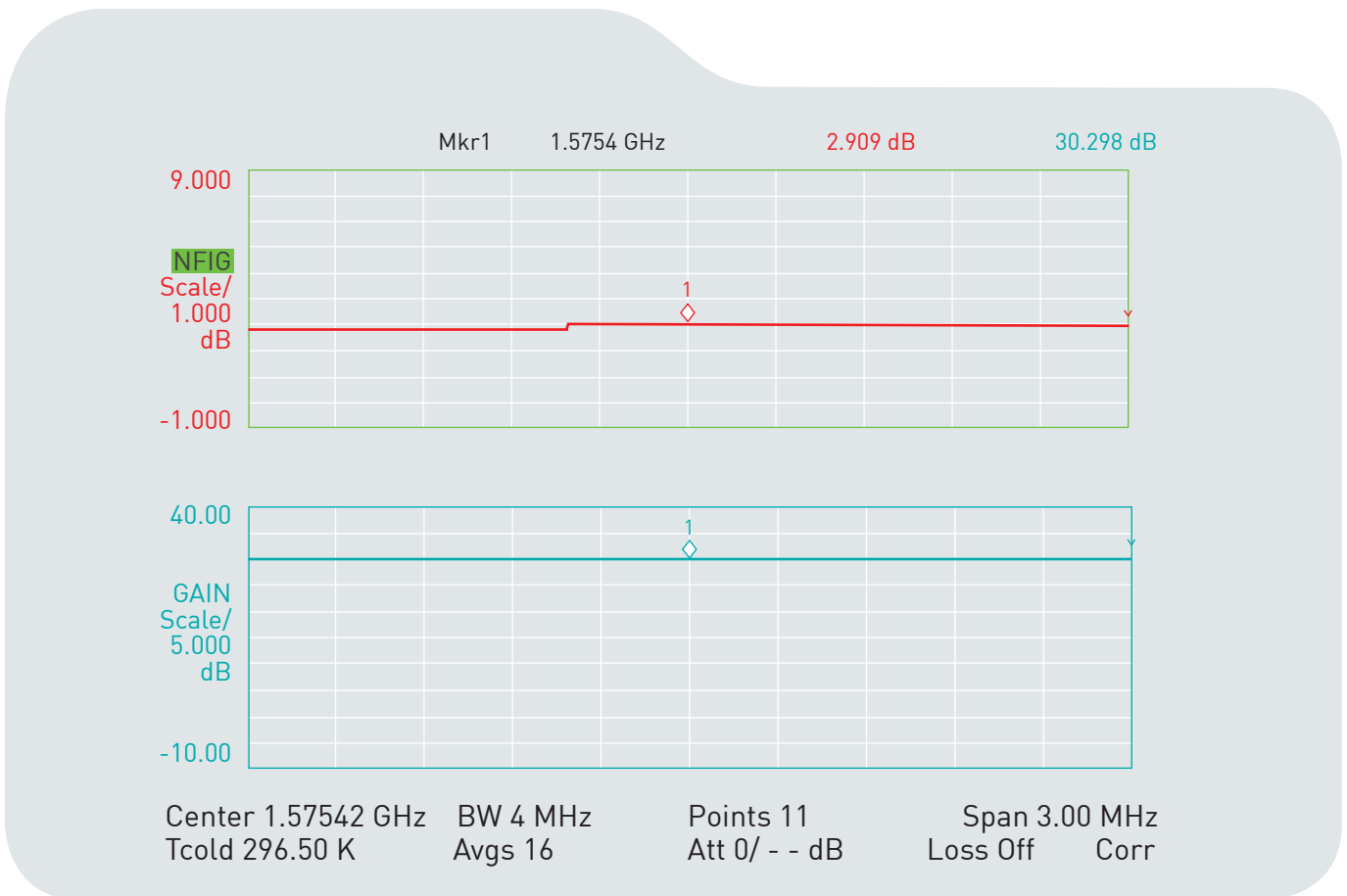

8. Drawing

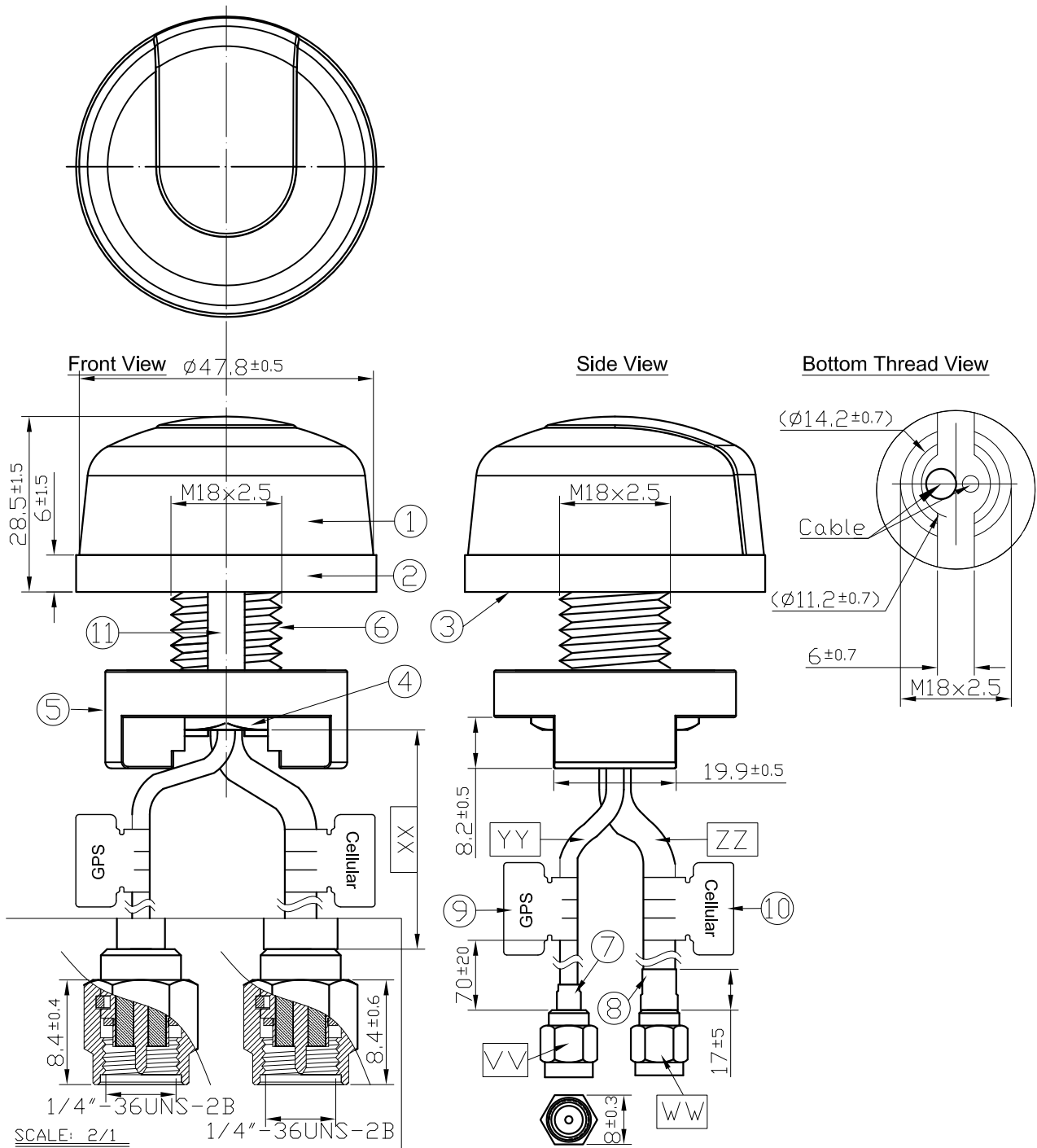

8. Drawing

	Name	Material	Finish	QTY
1	Housing	PC	White	1
2	Closed Cell Foam	DP-3060W	White	1
3	3M Double Adhesive	3M 9448 HK	White Liner	1
4	M18 Inner Nut	Carbon Steel	Ni Plated	1
5	Outer Nut Cover	ABS	White	1
6	M18x2.5 Thread	Zinc Alloy	Ni Plated	1
7	Heat Shrink Tube	PE	Black	2
8	GPS Label	Coated Paper	Orange	1
9	Cellular Label	Coated Paper	Blue	1
10	Rubber Stopper	Rubber	Black	1

	Name	Spec	Finish	QTY
VV	Connector Type	SMA(M) ST	Gold	1
WW	Connector Type	SMA(M) ST	Gold	1
XX	Cable Length	3000±60mm		1
YY	Cable Type	RG174	Black	1
ZZ	Cable Type	CFD 200	Black	1

9. Installation

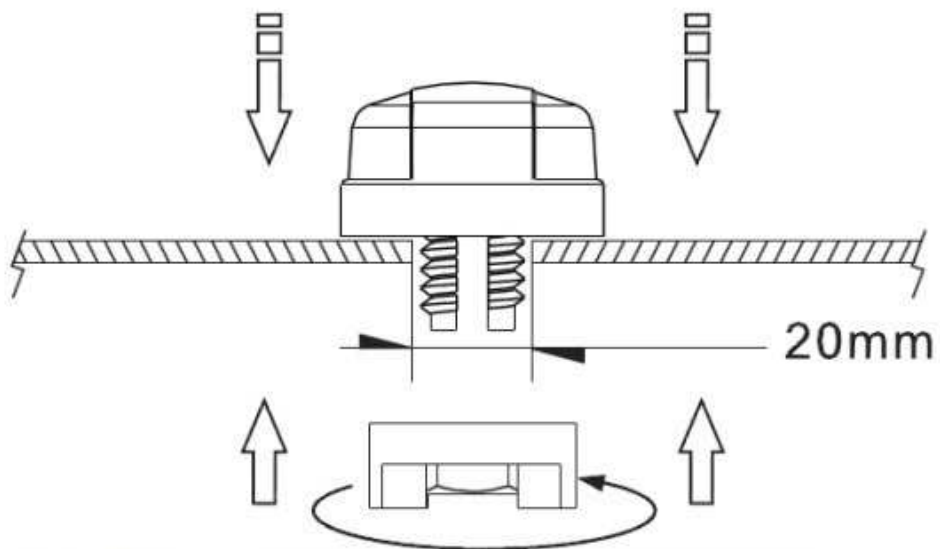

Recommended torque for Mounting is 24.5N·m
Maximum torque for mounting is 29.4N·m



10. Packaging

1pcs antenna per big PE bag
40 big PE bags per box

Unit : mm

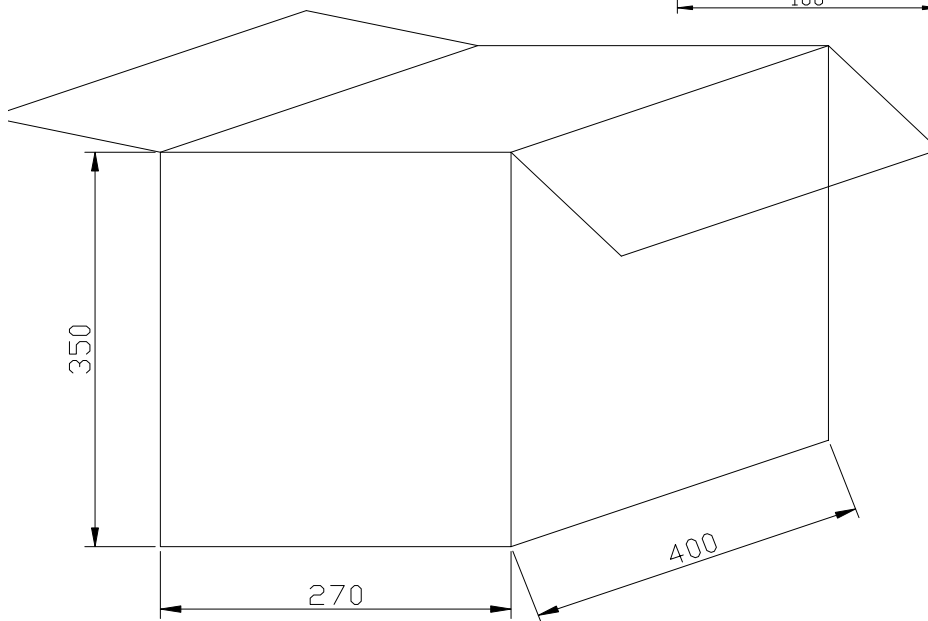
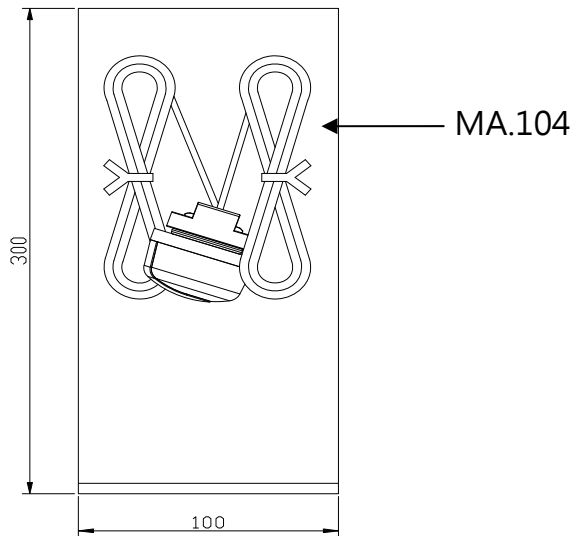

Taoglas makes no warranties based on the accuracy or completeness of the contents of this document and reserves the right to make changes to specifications and product descriptions at any time without

notice. Taoglas reserves all rights to this document and the information contained herein.

Reproduction, use or disclosure to third parties without express permission is strictly prohibited.

Copyright © Taoglas Ltd.