



Chipsmall Limited consists of a professional team with an average of over 10 year of expertise in the distribution of electronic components. Based in Hongkong, we have already established firm and mutual-benefit business relationships with customers from,Europe,America and south Asia,supplying obsolete and hard-to-find components to meet their specific needs.

With the principle of “Quality Parts,Customers Priority,Honest Operation,and Considerate Service”,our business mainly focus on the distribution of electronic components. Line cards we deal with include Microchip,ALPS,ROHM,Xilinx,Pulse,ON,Everlight and Freescale. Main products comprise IC,Modules,Potentiometer,IC Socket,Relay,Connector.Our parts cover such applications as commercial,industrial, and automotives areas.

We are looking forward to setting up business relationship with you and hope to provide you with the best service and solution. Let us make a better world for our industry!



Contact us

Tel: +86-755-8981 8866 Fax: +86-755-8427 6832

Email & Skype: info@chipsmall.com Web: www.chipsmall.com

Address: A1208, Overseas Decoration Building, #122 Zhenhua RD., Futian, Shenzhen, China



Surge Protection Devices

SD Series Data and Signal Protection SLP Series Data and Signal Protection MA15 Series AC and DC Power Protection TP48 Series Transmitter and Sensor Protection

NEW



MA15 Series AC & DC Power Protection

The MA15 Series of surge protection devices protects electronic equipment and computer networks against the effects of noise pollution induced in power supplies. MA15 units filter out and suppress the effects of industrial noise and surges caused by lightning, switching devices, thyristor controls, transmission system overloads and power-factor correction circuits.

Product Features:

- 18kA surge protection and RFI filtering
- Protects panel loads up to 15 Amps in series, unlimited Amps in parallel
- Suitable for AC or DC application
- Thermal and short circuit protection
- LED status indication feature
- 10 year product warranty

SD Series SLP Series Data and Signal Protection

The SD Series are ultra-slim user-friendly devices for protecting electronic equipment and systems against surges on signal and I/O cabling, and the SLP Series provides 20kA power surge protection for process control, equipment systems and distribution panels.

Product Features:

- Range of ATEX Certified intrinsically safe surge protectors
- Ultra-slim and space saving designs; easy installation
- Multistage hybrid protection circuitry - 10kA maximum surge current for SD Series, and 20kA maximum surge current for SLP Series
- Range of voltage ratings ideal for process I/O applications
- Designed for high bandwidth, low resistance applications; RTD, Public Switch Telephone Network (PSTN) and 3-wire transmitter versions available in SD Series
- Surge protection for two loops or one 4-wire circuit per SLP Series module
- 10 year product warranty

The SD and SLP Series surge protection devices provide unparalleled packing densities, application versatility, proven and reliable hybrid circuitry, simple installation and optional 'loop disconnect' facilities (SD Series). These features make the SD and SLP Series the ultimate surge protection solutions for process control equipment, I/O systems and communications networks.

TP48 Series Transmitter and Sensor Protection

The TP48 Series of transmitter protectors safeguards electronic process transmitters against induced surges and transients from field cabling. They uniquely provide a level of protection for 2, 3 and 4 wire field-mounted transmitters that greatly exceeds the optional transient protection facilities available from the transmitter manufacturers without any additional wiring, conduit modifications or other expensive extras.

Product Features:

- Easy and direct mounting – simply screw into spare conduit entry
- Intrinsically safe; flameproof to CENELEC standards; ATEX approved
- Parallel connection avoids introduction of resistance into loop

Canada

Weidmuller, Canada
10 Spy Court
Markham, Ontario L3R 5H6
Telephone: (800) 268-4080
Facsimile: (905) 475-2798
Email: info1@weidmuller.ca
Website: www.weidmuller.ca

Mexico

Weidmuller, Mexico
Blvd. Hermanos Serdán 698
Col. San Rafael Oriente
Puebla, Puebla, Mexico
C.P. 72029
Telephone: 01 222 2686267
Facsimile: 01 222 2686219
Email: clientes@weidmuller.com.mx
Website: www.weidmuller.com.mx

United States

Weidmuller
821 Southlake Blvd.
Richmond, Virginia 23236
Telephone: (800) 849-9343
Facsimile: (804) 379-2593
Email: info@weidmuller.com
Website: www.weidmuller.com

Weidmüller 

Surge Protection Devices



SD Series

The exceptionally high packing densities are the result of an ultra slim footprint for individual modules, which can double-up as feedback terminals. Each module provides full hybrid surge protection for 2 and 3-wire loop protection.

Modules with a comprehensive range of voltage ratings cover all process related signals such as RTDs, Thermocouples (THCs), 4 - 20mA loops, telemetry outstations, shut-down systems and fire and gas detectors.

The optional loop disconnect featured on the SD07, SD16, SD32 and SD55 modules allows users to perform commissioning and maintenance without removing the surge protection device. In addition, a third connection on the field and safe side of the module is provided for safe termination of shields.

For three wire applications the specially designed SDRTD (Resistance Temperature Detector) and the SD32T3, (for separately powered 4 - 20mA loops) provide full 3-wire protection in a single compact unit. The SD07R3 provides protection of 3-wire pressure transducers on low power circuits.

For higher bandwidth applications, the SDR Series meets the demands of today's highest speed communication systems.

120V and 240V AC versions are available for I/O and power supplies up to three Amps of load current.

Telephone networks can be protected by the SDPSTN.

All modules are DIN-rail mountable on a TS-35 rail. A comprehensive range of mounting and grounding accessories are available.



SLP Series

The multi-stage hybrid surge protection network at the heart of the SLP uses a combination of solid state electronics and a gas filled discharge tube (GDT) to provide surge protection up to 20kA. This impressive surge protection circuit is designed to exhibit exceptionally low line resistance and adds only a minimal voltage drop to the circuit.

The SLP device does not adversely affect the performance or operation of the loop or combined equipment during operation. The device allows signals to pass with very little attenuation, while diverting surge currents safely to the ground and clamping output voltages to safe levels.

Fully automatic in operation, SLP devices react immediately to ensure that equipment is never exposed to damaging surges between lines or the lines and ground. Reacting instantly, the SLP redirects surges safely to the ground and resets automatically.

The versatile SLP series provides full hybrid surge protection, combining protection for two process loops into one case.

For higher bandwidth applications, the SLP series has been developed to meet the demands of today's highest speed communication systems.

SD Series Guide to applications and selection

The SD Series of signal protection devices includes models for a full range of applications operating at voltages up to 250V ac. The optional fuse/disconnect package provides both fused protection against fault currents and a convenient method of isolating field circuitry from protected circuitry without requiring additional disconnect terminals. The standard fuse (replaceable) is rated 250mA. 50mA fuses are available by special request. Solid links can be used in applications where only the disconnect feature is required.

This feature is important in applications where a signal protection device is used with a bulk power supply feeding multiple loops. **The individual fuse module prevents a fault or follow on current on one loop disrupting the power supply to the others.** In addition, loops can be removed from the circuit for maintenance or added without requiring additional disconnect terminals.

The following guide provides application information for the SD series. For technical information, see page 9.

Analog inputs (high-level)

2-wire transmitters, 4-20mA, conventional and smart

SD32 and SD55 are recommended for use with conventional and smart 4-20mA transmitters (fed by a well-regulated supply), the choice dependent upon the maximum working voltage of the system (32V and 55V respectively). The diagram illustrates an application using the fuse/disconnect. Both models are available in 'X' versions without the optional fuse/disconnect feature.

Analog inputs (low-level)

RTDs, Thermocouples (THCs) and mV sources using the SDRTD.

For optimum accuracy, the energizing current should be chosen to ensure the voltage across the RTD does not exceed 1V over the full measurement range. When using a PT100 device, an energizing current of 1mA is recommended.

Photocells and turbine flowmeters

Depending upon the operational voltage, the SD07 or SD16 are the preferred choices for this application. SD07X and SD16X are also suitable.

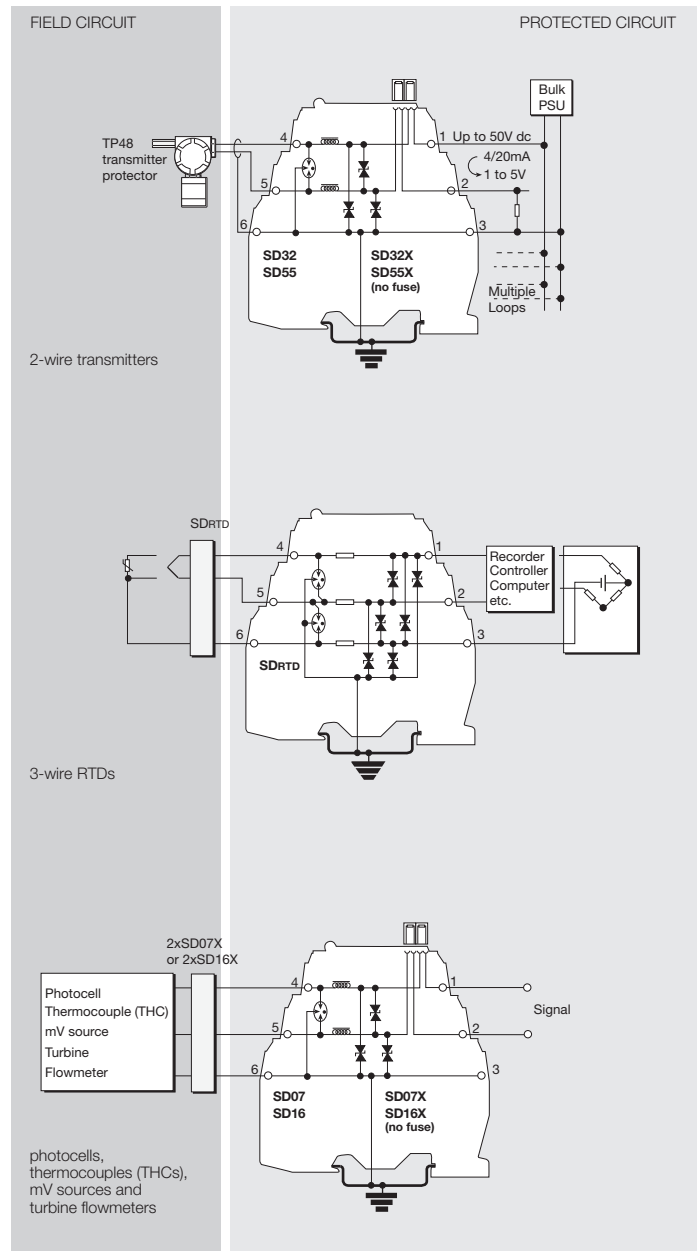

Analog outputs

Controller outputs (I/P converters)

Dependent on the working voltage, recommendations include the SD16, SD32 and SD55, and the equivalent 'X' versions.

Digital (on/off) inputs - Switches

Suitable signal protection devices include the SD07, SD16, SD32 and SD55 modules, and the equivalent "X" versions. The choice is dependent upon the operating voltage of the system.

Digital (on/off) outputs - Alarms, LEDs, solenoid valves, etc.

The SD32 or SD32X are the recommended choice for this application.

Telemetry Public Switch Telephone Network (PSTN) - Telemetry outstations

The SDPSTN has been designed specifically for the protection of signals transmitted on public switched telephone networks.

AC supplied equipment - PLC, I/O systems

The recommended choice for systems on 110-120V ac is the SD150X ; for 220-240V ac systems, the SD275X is recommended.

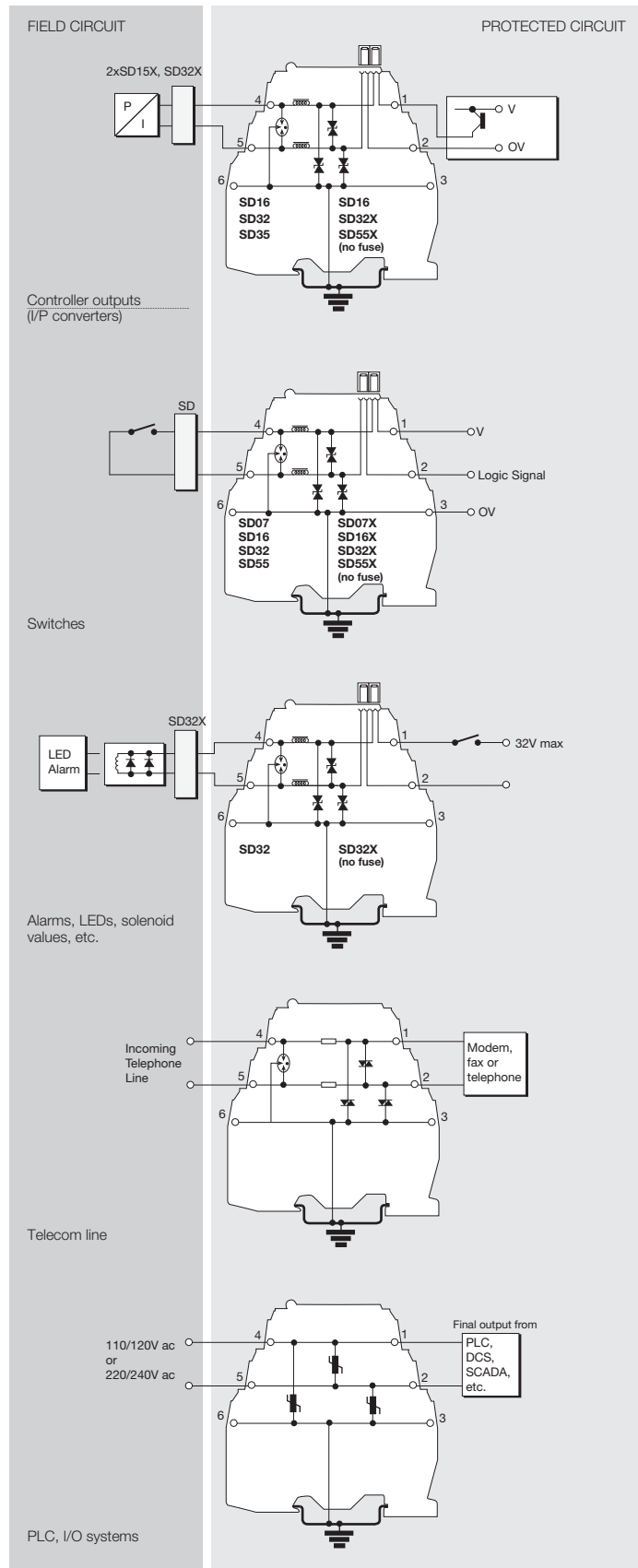

Transmitter and sensor protection

Transmitters and sensors are widely used in highly exposed areas and where lightning damage is common. In many cases, the ideal solution for 2-wire transmitters or sensors is the TP48, which mounts directly onto the transmitter via spare conduit entries or a tee fitting. Where these entries are not available or 3-wire devices are used, the compact design and simple installation of the SD Series makes it an ideal choice for transmitter protection.

The SDs within the junction box should be installed as close as possible to the sensor or transmitter they are protecting, but no further than one meter away. A bond is required from the general mass of steelwork to the sensor or transmitter housing, using either a flat short braid or a cable at least 0.16 inch² (4mm²) cross sectional area. In most instances, this bond is made automatically by fixing the metallic transmitter housing to the plant structure and ensures the voltage difference between the signal conductors and the transmitter housing is below the transmitter's insulation rating. Please note that the transmitters or sensors are connected to the SD protected equipment terminals, not the field cables.

2-wire transmitters or sensors

4-20mA transmitters - conventional and smart

The SD16X, SD32X and SD55X are an excellent alternative if the TP48 is not an acceptable solution, either because of technical suitability or mounting difficulties.

3-wire transmitters or sensors

Vibration Sensors and 4-20mA loop process control systems generally require three wire connections when powered from an external source. This may be accomplished in one unit by using the SD32T3 3-terminal Surge Protection Device (SPD). Because the SD32T3 protects all three conductors within the same unit, higher protection is achieved because the SPD hybrid circuitry is common to all three wires.

The SD07R3, SD16R3, SD32R3 and SD55R3 are also suitable for the protection of 3-wire pressure transducers on low power circuits.

4-wire transmitters or sensors - Flow meters, level detectors, etc.

4-wire systems such as level detectors require two SDs, one for the supply and the other for the transmitter output. Generally the voltages across the pairs are similar, so the recommended choice is a pair of SD16X, SD32X or SD55Xs. Dependent upon the supply voltage, AC powered transmitters should be protected with an SD150X for the supply inputs.

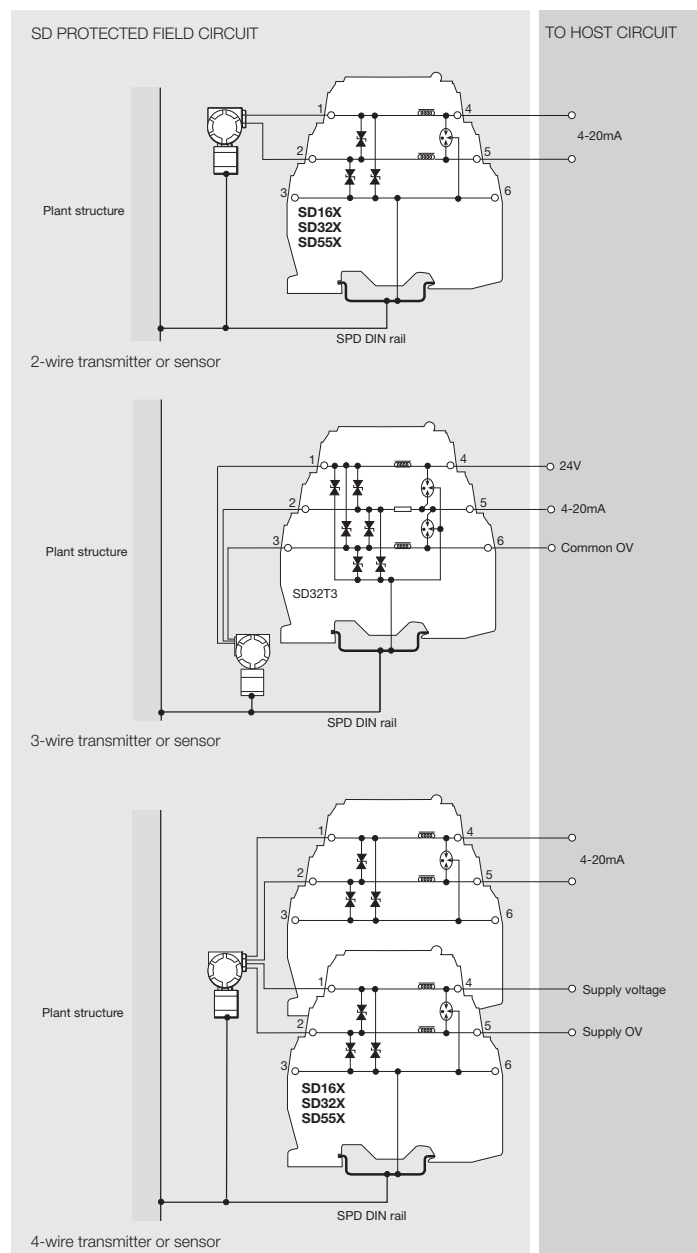

Communication systems protection

High-speed data links between buildings or one part of a plant to another have become more common with the widespread use of smart transmitters and the increase in remote installations. The SD Series has an SPD suitable for all process I/O applications with a choice of low resistance units, high bandwidth and a variety of voltage ranges. Featuring an extremely high bandwidth, the SDR Series is designed to meet the requirements for high speed data links.

Communication systems

RS232, RS422, RS485

The recommended choice for these applications is the SD16R or SD32R depending on the maximum driver signal.

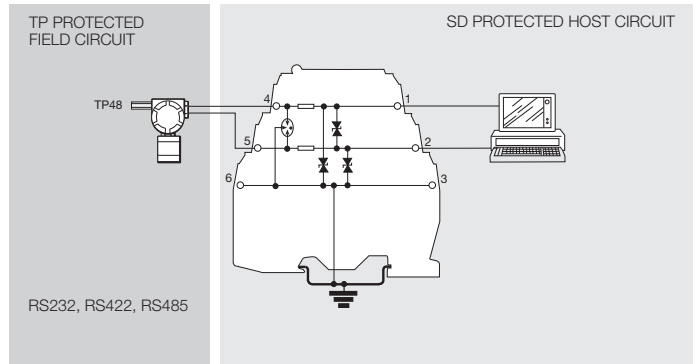

Bus powered systems

There are a variety of bus powered systems specially designed for the process industry. The ideal surge protection device for these systems is the SD32R, with a very high bandwidth and modest in-line resistance.

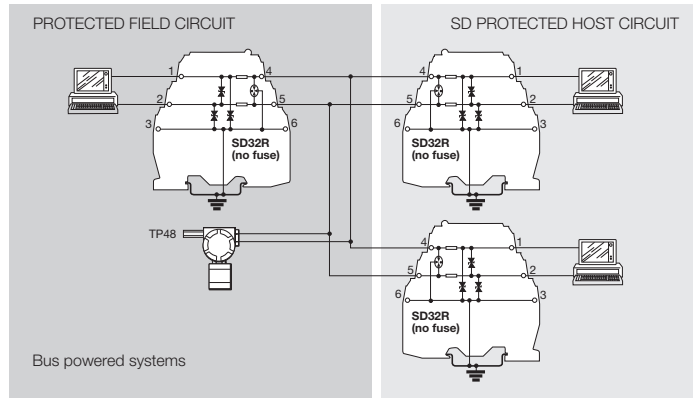

Typical Applications

Table 1 shows suitable SD devices for different applications. In some applications alternative devices may be used, for example, where lower in-line resistance or a higher voltage power supply is used.

MTL Surge Technologies has operationally tested the recommended SD Series units with the representative highways listed. However, no formal approval for their use in these systems has been sought from the respective bodies.

Table 1

Application	Preferred Part No.	Alternate Part No.
Allen Bradley Data Highway Plus	SD16R	
Foundation Fieldbus		
31.25kbits/s voltage mode	SD32R	
1.0/2.5 Mbits/s	SD55R	
HART	SD32X	SD32, SD32R
Honeywell DE	SD32X	SD32, SD32R
LonWorks		
FFT-10	SD32R	
LPT-10	SD55R	
TP-78	SD07R	
IS78†	SD32R	
Modbus & Modbus Plus (RS485)	SD16R	
PROFIBUS		
DP	SD32R	
PA (IEC 1158, 31.25 kbits/s)	SD32R	
RS232	SD16	SD16X
RS422	SD07R	
RS423	SD07R	
RS485	SD07R	
WorldRP (IEC 1158)	SD32R	
31.25 kbits/s voltage mode		
1.0/2.5 Mbits/s	SD55R	

Hazardous area applications

Zone0/Zone1

The dangers from lightning induced sparking in Zone 0 are considered real enough to require preventative measures. IEC 60079-14 (1996-12) Electrical apparatus for explosive gas atmospheres Part 14: Electrical installations in hazardous areas (other than mines) stresses the importance of SPDs in hazardous areas. An outdoor installation where there is a high likelihood of both lightning induced transients and combustible gases requires the installation of SPDs to prevent possible ignition of the gases. Areas seen particularly at risk include flammable liquid storage tanks, effluent treatment plants, distillation columns in petrochemical works and gas pipelines.

SPDs for transmitter protection should be installed in Zone 1, sufficiently close to the Zone 0 boundary to prevent high voltages entering Zone 0. The distance from the SPD to Zone 0 should be less than 36" where possible. In practice the SPD would normally be mounted on the transmitter or sensor housing which usually lies in Zone 1 and is very close to Zone 0. Because there is only a very small free volume, the SD series is suitable for mounting in flameproof or explosion proof enclosures.

Zone 2

The SD series is suitable for protecting electrical circuits in Division 2, Zone 2 and can be used without affecting the safety aspects of the circuit. Non-incendive (low-current) circuits can be protected using any SD series unit mounted in either the safe or hazardous area, including those with the fuse disconnects facility. Nonarcing (high current) circuits can also be protected, however SPDs with the fuse disconnect facility may only be mounted in the safe area. For use in these circuits the units must be mounted in a suitable enclosure. In most cases the minimum requirements are IP54 and 7Nm resistance to impact. The SD series is self certified by MTL Surge Technologies as suitable for this purpose.

Certification

Introducing surge protection into Intrinsically Safe (IS) circuits is trouble free as long as the current and power parameters are not exceeded. In the SD series, the SD**X, SD**R, SD**R3, SDRTD and SD**T3 all have ATEX certification for use in IS circuits located in Zones 0, 1 or 2. The certification parameters for the SD**X and SD**T3 are:

Ex ia IIC T4, Li = 0.22mH

$I_i = 260\text{mA}$ for U_i up to 20V

$I_i = 175\text{mA}$ for U_i up to 26V

$I_i = 140\text{mA}$ for U_i up to 28V

$I_i = 65\text{mA}$ for U_i up to 60V

The certification parameters for the SD**R, SD**R3 and SDRTD are:

Ex ia IIC T4, Li = 0

$I_i = 260\text{mA}$ for U_i up to 60V

The power rating for each of the above is dependent on the table shown below.

$P_i = 1\text{W}$ (-30°C to +75°C)

$P_i = 1.2\text{W}$ (-30°C to +60°C)

$P_i = 1.3\text{W}$ (-30°C to +40°C)

The SD** series are classified as simple apparatus and are intended for use in Zone 2 or safe areas only, because their fuses are not fully encapsulated.

Installation

Positioning

The SDs should be mounted on the field wiring side to ensure that any surges entering from the field do not damage any intrinsically safe barriers or galvanic isolators in the system. The SDs and intrinsically safe interface should be mounted close to each other but on separate DIN-rails in order to maintain the required 1.97" (50mm) clearance between safe area and hazardous area terminals of the IS interface.

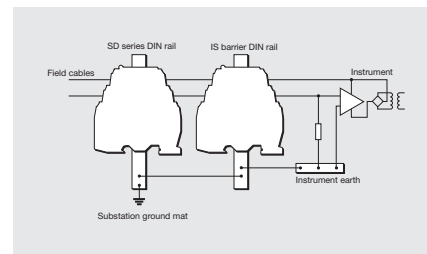

Grounding

The recommended grounding for field-mounted devices has been illustrated previously. The grounding at the control panel is more critical as there are usually a number of grounding systems, each with their own requirements. The grounding system illustrated here replaces the instrument 0V bond, the control system PSU bond and the IS ground with one single ground connection to meet all the design requirements and give the most effective protection against the effects of lightning induced surges.

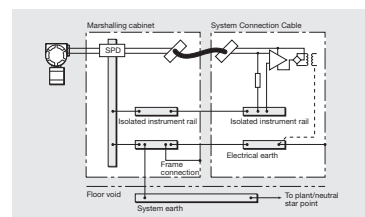

In all installations utilizing safety related apparatus, consideration should be given to protecting the system supply and any long communication cable.

Specifications SD Series

All figures typical at 77°F (25°C) unless otherwise stated

Protection

- Full hybrid line to line
- Each line to screen/ground

Max. discharge surge current (I_{max}) (8/20μs)

- 10kA (8/20μs)
- 6.5kA (SD150X and SD275X only)

Max. discharge surge current (I_{sn})

- 3kA (8/20μs)

Lightning impulse current (I_{imp}) (10/350μs)

- 2.5kA
- 1.0kA (SD150X and SD275X only)

Response time

- <1ns

RTD resistance range (SDRTD)

- 10 to 1500

Degradation accuracy (SDRTD at 1mA)

- 0.1% (RTD resistance > 100)
- 0.1W (RTD resistance < 100)

Ambient temperature

- 40°C to +80°C - working (-40°F to 176°F)
- 40°C to +80°C - storage (-40°F to 176°F)

Humidity

- 5 to 95% RH (non-condensing)

Category tested

- A2, B2, C1, C2, C3

Overstressed fault mode I_N=3kA

- 12kA
- 9kA (SD150X and SD275X only)

Impulse durability (8/20μs)

- 10kA
- 6.5kA (SD150X and SD275X only)

Terminals

- 2.5mm² (12 AWG)

Mounting

- T-section DIN-rail 35 x 7.5 or 35 x 15mm rail (1.38" x 0.3" x 0.6")

Weight

- 70g approximately (2.5oz)

Case flammability

- UL94 V-2

AC durability

- 1A_{rms}, 5T

Service conditions

- 80kPa - 160kPa
- 5% - 95% RH

EMC compliance

- To Generic Immunity Standards, EN 50082, part 2 for industrial environments

R&TTE compliance

- EN 50082-2 : 1995
- EN 41003 : 1999
- EN 60950 : 1992 (not applicable to SD150X and SD275X)

LVD compliance

- SD150X & SD275X
- EN 60950 : 1992
- EN 61010 : 1995
- SDPSTN
- EN 41003 : 1999

IEC compliance

- EN 61643-21:2001

Approvals

Country (Authority)	Standard	Certificate/File No.	Approved for	Product
Canada, USA (CSA/C/US)	CSA C22.2 No. 0-M1991 CSA C22.2 No. 157-M1992 UL 913, 5th edition CSA C22.2 No. 142-M1987 CSA C22.2 No. 213-M1987 UL 508, 17th edition UL 1604, 3rd edition	LR 103652-3	EEx ia Class 1, Groups A, B C and D, T4 Class 1, Div 2 Groups A,B,C, D T4	SD07,SD16,SD32,SD55, SD07X,SD16X,SD32X, SD55X,SD07R,SD16R, SD32R,SD55R,SDRDT, SD32T3,SD07R3,SD16R3, SD32R3,SD55R3
USA (UL)	UL 497B Listed	E220693	Isolated loop communication circuits	SD07,SD16,SD32,SD55 SD07X,SD16X,SD32X SD55X,SD07R,SD16R SD32R,SD55R,SD07R3 SD16R3,SD32R3,SD55R3 SD32T3,SD55T3, SD07X3,SD16X3,SD32X3, SD55X3,SDRDT
USA, Canada (UL)	UL 1449 Recognized Component	E217523	AC power protection	SD150X,SD275X

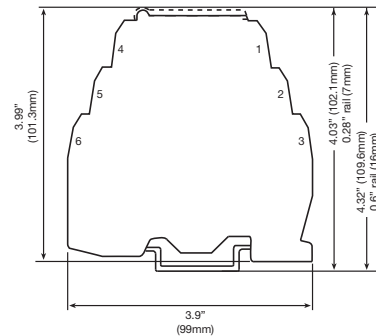

Ordering Data	Part No.	Part No.	Part No.	Part No.
	SD07	SD16	SD32	SD55
Technical Data				
Nominal voltage+(U _n) Vdc	7	16	32	55
Nominal voltage+(U _n) Vac	5	11	22	38
Nominal current (I _n) mA	250	250	250	250
Series resistance W/line	4.2	4.2	4.2	4.2
Max. leakage current μA	500	5	5	5
Rated voltage (MCOV) U _c	7.7	17	36	62
Voltage protection level (U _p) @1kV/μs V	<12	<25	<45	<90
Residual voltage @ I _{sn} V	30	40	60	100
Bandwidth frequency f _G	25	25	25	25
Special feature	fuse disconnect	fuse disconnect	fuse disconnect	fuse disconnect

Ordering Data	Part No.	Part No.	Part No.	Part No.
	SD07R	SD16R	SD32R	SD55R
Technical Data				
Nominal voltage+(U _n) Vdc	7	16	32	55
Nominal voltage+(U _n) Vac	5	11	22	38
Nominal current (I _n) mA	400	400	400	400
Series resistance W/line	2.7	4.7	10	10
Max. leakage current μA	500	5	5	5
Rated voltage (MCOV) U _c	7.7	17	36	62
Voltage protection level (U _p) @1kV/μs V	<12	<25	<45	<90
Residual voltage @ I _{sn} V	30	40	60	100
Bandwidth frequency f _G	50	50	50	50
Special feature	high Bandwidth	high Bandwidth	high Bandwidth	high Bandwidth

Ordering Data	Part No.	Part No.	Part No.	Part No.	
	SD07X	SD16X	SD32X	SD55X	
Technical Data					
Nominal voltage+(U _N) Vdc	7	16	32	55	
Nominal voltage+(U _N) Vac	5	11	22	38	
Nominal current (I _N) mA	400	400	400	400	
Series resistance W/line	2.2	2.2	2.2	2.2	
Max. leakage current µA	500	5	5	5	
Rated voltage (MCOV) U _C	7.7	17	36	62	
Voltage protection level (U _p) @1kV/µs V	<12	<25	<45	<90	
Residual voltage @ i _{SN} V	30	40	60	100	
Bandwidth frequency f _G	25	25	25	25	
Special feature	low resistance	low resistance	low resistance	low resistance	

Ordering Data	Part No.	Part No.	Part No.	Part No.	Part No.
	SD32T3	SD07R3	SD16R3	SD32R3	SD55R3
Technical Data					
Nominal voltage+(U _N) Vdc	32	7	16	32	55
Nominal voltage+(U _N) Vac	22	5	11	22	38
Nominal current (I _N) mA	400	400	400	400	400
Series resistance W/line	2.2	2.7	4.7	10	10
Max. leakage current µA	5	500	5	5	5
Rated voltage (MCOV) U _C	36	7.7	17	36	62
Voltage protection level (U _p) @1kV/µs V	<45	<12	<25	<45	<90
Residual voltage @ i _{SN} V	60	30	40	60	100
Bandwidth frequency f _G	720	50	50	50	50
Special feature	3 terminal	3 terminal	3 terminal	3 terminal	3 terminal

Ordering Data	Part No.	Part No.	Part No.	Part No.	
	SDRTD	SDPSTN	SD150X	SD275X	
Technical Data					
Nominal voltage+(U _N) Vdc	1	162	170	339	
Nominal voltage+(U _N) Vac	0.75	114	120	240	
Nominal current (I _N) mA	>10	550	3A	3A	
Series resistance W/line	2.7	4.7	0.1	0.1	
Max. leakage current µA	0.3	5	250 ac rms; 170 ac	250 ac rms; 350 ac	
Rated voltage (MCOV) U _C	5	175	130 ac rms	275 ac rms	
Voltage protection level (U _p) @1kV/µs V	<12	<200	<400	<700	
Residual voltage @ i _{SN} V	30	235	450	850	
Bandwidth frequency f _G	50	4	-	-	
Special feature	3-wire RTD	PSNT	high current	high current	

Mounting Accessories	
0494920000	Rail Holder
Grounding/Ground Rail Accessories	
1010100000	Ground terminal, DIN rail mounted
Accessories (Replacement)	
SDF25	Replacement fuse pack - 250mA standard

Application	Preferred Part No.	Alternate Part No.	Application	Preferred Part No.	Alternate Part No.
Allen Bradley Data Highway Plus	SD16R		PROFIBUS		
Foundation Fieldbus			DP	SD32R	
31.25kbits/s voltage mode	SD32R		PA (IEC 1158, 31.25 kbits/s)	SD32R	
1.0/2.5 Mbits/s	SD55R		RS232	SD16	SD16X
HART	SD32X	SD32, SD32R	RS422	SD07R	
Honeywell DE	SD32X	SD32, SD32R	RS423	SD07R	
LonWorks			RS485	SD07R	
FFT-10	SD32R		WorldRP (IEC 1158)	SD32R	
LPT-10	SD55R		31.25 kbits/s voltage mode		
TP-78	SD07R		1.0/2.5 Mbits/s	SD55R	
IS78†	SD32R				
Modbus & Modbus Plus (RS485)	SD16R				

Specifications SLP Series

All figures typical at 77°F (25°C) unless otherwise stated

Maximum surge current
20kA (8/20µs waveform) per line

Leakage Current
<1mA @ working voltage

Maximum rated load current
1.50A

Loop resistance
2 Ohm

Capacitance
Line - Line - 60pF

Bandwidth
-0.1db @9kHz - 37MHz
-3dB @50MHz

Response time
<1ns

Ambient temperature
-40°C to +80°C (working)
-40°F to +176°F (working)
-40°C to +80°C (storage)
-40°F to +176°F (storage)

Humidity
5 to 95% RH (non-condensing)

Terminals
2.5mm² (12 AWG)

Electrical connections
Plug/header screw terminal strip

Mounting
T-section DIN-rail (35 x 15mm rail)

Weight
5oz (140g approximately)

Case flammability
UL94-V0

EMC compliance
BS EN 60950:1992
BS EN 61000-6-2:1999
BS EN 61010-1:1993

Dimensions

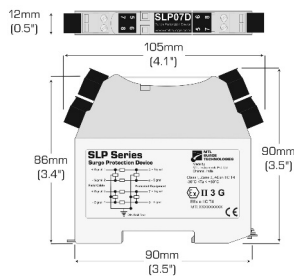

Connections

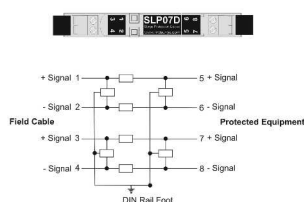

Approvals

Country (Authority)	Standard	Certificate/File No.	Approved for	Product				
ATEX	BS EN 60950:1992	ATEX0377X	EEx N IIC T4	SLP07D, SLP16D, SLP32D				
	BS EN 61000-6-2:1999							
	BS EN 61010-1:1993							
USA (FM)	Class Nos. 3600 (1998), 3610 (1999), 3611 (1999), 3615 (1989), 3810 incl. Supp 1 (1995-07 (1989-03), ANSI/NEMA 250 (1991), ISA-S12.0.01 (1999)	3011208	Intrinsically Safe: I/1/A-D, I/O/II C Non incandive: I/2/A-D, I/2/II C	SLP07D, SLP16D, SLP32D				
	Canada (FM)				C22.2 No. 213, 142, 94, 157, 30	3025374	IS/I/1/ABCD I/O/Ex ia/II C I/O/Ex ib/II C NE/I/2/ABCD NE/I/2/II C	SLP07D, SLP16D, SLP32D
					ANSI/NEMA 250			
					CAN/CSA-E79-0			
					CAN/CSA-E79-11			



Ordering Data	Part No.	Part No.	Part No.
	SLP07D	SLP16D	SLP32D
Technical Data			
Nominal voltage U _n	7V	16V	24V
Rated voltage (MCOV) U _c	8V	18V	32V
Nominal current I _n	1.50A	1.50A	1.50A
Nominal discharge current (8/20µs) i _{SN}	3kA	3kA	3kA
Max discharge current (8/20µs) I _{max}	20kA	20kA	20kA
Lightning impulse current (10/350µs) I _{imp}	2.5kA	2.5kA	2.5kA
Residual voltage @ i _{SN} U _p	10V	23V	40V
Voltage protection level @ 1kV/µs U _p	<8V	<18V	<38V
Bandwidth f _G	50MHz	50MHz	50MHz
Capitance C	60pF	60pF	60pF
Series resistance R	1.0	1.0	1.0
Operating Temperature Range	-40°C to +80°C	-40°C to +80°C	-40°C to +80°C
Category tested	A2, B2, C1, C2, C3, D1	A2, B2, C1, C2, C3, D1	A2, B2, C1, C2, C3, D1
Overstressed fault mode in=3kA	22kA	22kA	22kA
Impulse durability (8/20µs)	10kA	10kA	10kA
Degree of protection	IP20	IP20	IP20
AC durability	1Arms, 5T	1Arms, 5T	1Arms, 5T
Service conditions	80kPa - 160kPa 5% - 95% RH	80kPa - 160kPa 5% - 95% RH	80kPa - 160kPa 5% - 95% RH

Installation

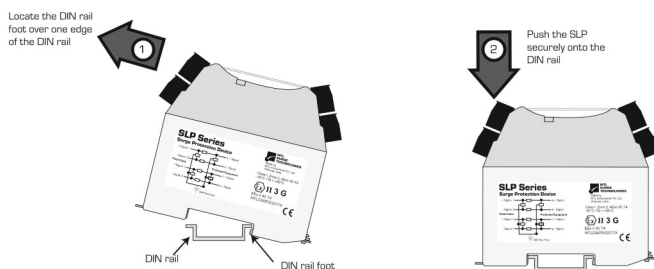



MA15 Series

Although industrial computers and PLCs are designed to be rugged, the extra protection provided by the DIN-rail mounting MA15 units is critical. Ideally suited for protecting panel mounted equipment and typically used in the controls section of a motor control center (MCC), the MA15 range provides surge and RFI protected power.

With a unique ‘three-stage’ combination of protection elements, these units suppress conducted RFI and voltage surges. The circuit elements are: (1) surge clipping components to absorb transient surges that may otherwise damage equipment, (2) a filter to suppress noise in the system and, (3) ring suppression. Ring suppression prevents surges causing the filter to ‘ring’ (oscillate) under low load conditions – an effect that actually accentuates interference in most commercially available filters.

Suitable for AC or DC application, MA15 units reduce both electromagnetic emissions and the susceptibility of the associated equipment to emissions from other sources. MA15 devices also offer installation flexibility. To protect circuits rated 15A or less, MA15 devices should be installed in series. To protect higher current circuits, simply install the MA15 in parallel.

LED status indication is standard with the MA15 units. Thermal fusing is also incorporated into each 18kA rated device as an additional safety feature. MA15 modules also offer short circuit protection for added safety.

Specifications MA15 Series

Maximum surge current: 18kA (8/20 μ s) per mode	
Maximum leakage current: <0.3mA	
Maximum continuous operating current	
15A series connection	
Unlimited Amps in parallel	
Maximum continuous operating voltage	
25% above nominal	
Limiting voltage	Let through voltage
@ 500A ring	
120V/140V versions	295V
240V/280V versions	356V
@ 500A 8/20 μs	
120V/140V versions	320V
240V/280V versions	800V
@ 3kA 8/20 μs	
120V/140V versions	396V
240V/280V versions	975V
@ 10kA 8/20 μs	
120V/140V versions	585V
240V/280V versions	1210V
Maximum attenuation (typical): -55dB @ 100MHz	
Modes protected: L-N, L-G, N-G	
Ambient temperature limits	
-40°F to +185°F (working)	
-40°C to +85°C (working)	
Humidity	
95% RH (non-condensing)	
Casing	
Polyimide-PA, with G- or T-section	
(Top-hat) DIN-rail mounting foot	
Connectors	
Screw terminal	
Terminals	
0.1 inch ² (2.5mm ²) 12 AWG	
Mounting	
G- or T-section (“Top-hat”) or	
1.4 inch (35mm) DIN rail	
Weight	
3.53oz (100g)	
EMC compliance	
BS EN 60950 : 1992	
BS EN 61000-6-2 : 1999	
LED Indication	
Green LED on Protection present	
Green LED off Internal failure	

All figures typical at 77°F (25°C) unless otherwise stated

Ordering Data		
Part No.	AC	DC
MA15D1SI	120V, 47-63Hz	140V
MA15D2SI	240V, 47-63Hz	280V

Approvals

Country (Authority)	Standard	Approved for	Product No.
United States	UL 1449	AC Power Product	MA15D1SI,
Canada	Recognized Component		MA15D2SI
United States	UL 1449	Hazardous Locations	MA15D1SI,
Canada	Recognized Component	Class I, Division 2	MA15D2SI
	UL 1604	Groups A, B, C and D	

Dimensions

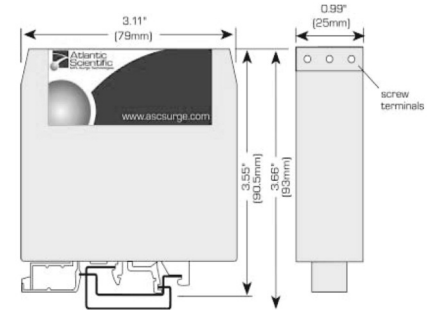

Installation

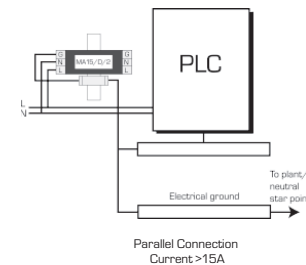
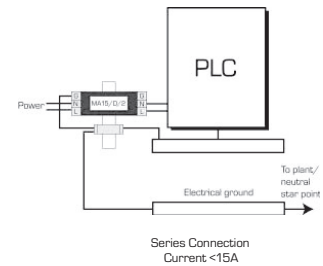

The grounding of the surge protector and the protected equipment is very important and, if possible, should be accomplished as illustrated.

Please note that the unit is marked Line and Load and it is important that the unit is installed with the Line side connected to the incoming power and the Load connected to the equipment to be protected. For parallel application however, the Line side is connected to the incoming power and the Load left unconnected.



The TP Series protection network

consists of high-power, solid-state electronics and a gas-filled discharge tube capable of diverting 10kA impulses. The whole unit is encased in an ANSI 316 stainless steel housing, threaded for the common conduit entries used on process transmitters. Versions are available for 1/2" NPT, 20mm ISO, and G1/2" (BSP 1/2 inch) threaded entries.

Specifications TP Series

All figures typical at 77°F (25°C) unless otherwise stated

Maximum surge current
10kA peak current (8/20µs waveform)

Leakage current
Less than 10µA at maximum working voltage

Working voltage
48 VDC maximum

Bandwidth
1MHz

Resistance
No resistance introduced into loop

Ambient temperature limits
-20°C to +80°C (working)
-40°C to +80°C (storage)

Humidity
5% to 95% RH (non-condensing)

Electrical connections
TP48
3 flying leads (line1, line 2 & ground)
TP48 3 Wire
4 flying leads (+ve, -ve, signal & ground)
TP48 4 Wire
5 flying leads (+ve, -ve, signal +ve, signal -ve, ground)
Wire size 32/0.2 (1.0mm², 18 AWG)
Lead length 250mm (minimum)

Casing
ANSI 316 stainless steel hexagonal barstock, male thread

Threads
TP48-3-N & TP48-4-N 1/2" NPT
TP48-3-I & TP48-4-I 20mm ISO (M20 x 1.5)
TP48-3-G & TP48-4-G G 1/2" (BSP 1/2")

Weight
175g (6.2oz)

Dimensions
See Figure 1

EMC compliance
To Generic Immunity Standards EN50082, part 2 for industrial environments

Electrical safety
EEx ia IIC T4, Ceq=0, Leq=0; the unit can be connected without further certification into any intrinsically safe loop with open circuit voltage <60V and input power <1.2W.
EEx d IIC T4; the unit is apparatus-approved to flame proof (explosionproof) standards, and can be fitted into a similarly approved housing.

Approvals

Country (Authority)	Standard	Certificate/File No.	Approved for	Product
Atex Directive 94/9/EC	BS EN 50021:1999	TML02ATEX0032X	Ex n II T6 (-40°C<Tamb<+60°C) EEx n II T5 (-40°C<Tamb<+85°C)	TP48-X-Y-Z
USA (FM)	Class Nos. 3600 (1998), 3610 (1999), 3611 (1999), 3615 (1989), 3810 incl. Supp 1 (1995-07 (1989-03), ANSI/NEMA 250 (1991), ISA-S12.0.01 (1999)	3022293	Intrinsically Safe: I, II, III/1/A-G, I/O/IIC Explosionproof: I/1/A-D Non incendive: I/2/A-D, I/2/IIC Dust ignition proof: II,III/1/EFG Special protection: II/2/FG	TP48-X-Y-Z
Canada (FM)	C22.2 No. 157 C22.2 No. 213 C22.2 No 142 C22.2 No. 94 C22.2 No. 30	3025374	Intrinsically Safe: I, II, II/1/A-G, I/O/IIC Explosionproof: I/1/A-D Nonincendive: I/2/A-D, I/2/IIC Dust ignition proof: II, III/1/EFG Special protection: II/2/FG	TP48-X-Y-Z
Global	IEC 60079-0:2004 IEC 60079-11:2006 IEC 61241-0:2004 IEC 61241-1:2004	IECEX BAS 07.0045X	Ex ia IIC T4/T5/T6 Ex tD A20 IP6X T85°C/T100°C/ T135°C	TP48-X-Y-NDI

Key: X = 3 or 4 or blank, Y = N, I or G, Z = NDI



Ordering Data	
Part No.	
TP48NNDI	Certified SPD - 1/2" NPT thread
TP48INDI	Certified SPD - 20mm ISO thread
TP48GNDI	Certified SPD - G 1/2" (BSP 1/2 inch)
TP483NNDI	Certified SPD - 1/2" NPT thread
TP483INDI	Certified SPD - 20mm ISO thread
TP483GNDI	Certified SPD - G 1/2" - BSP 1/2 inch
TP484NNDI	Certified SPD - 1/2" NPT thread
TP484INDI	Certified SPD - 20mm ISO thread
TP484GNDI	Certified SPD - G 1/2" - BSP 1/2 inch

Dimensions

Figure 1

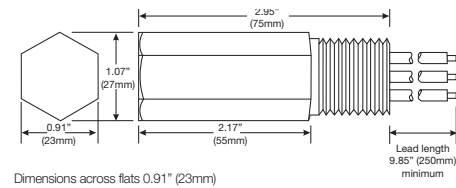

Dimensions across flats 0.91" (23mm)

Installation

The TP units are designed for mounting directly into an unused conduit entry on a process transmitter housing. Generally, two such entries are provided, one of which is used for the loop wiring. On the unused entry, the blanking plug or other closure device is removed and an appropriately threaded TP screwed into its place. The transmitter specification should provide information indicating the required thread type. TP units can be installed using thread adaptors if necessary, including certified adaptors in hazardous area applications. For applications where two conduit entries are not provided or where both are used for electrical connections, TP units can be housed in conventional conduit hub or junction boxes, provided access to the loop terminals is possible. Figure 2 shows connection details for 3 & 4 wire process transmitter.

Figure 2

