



Chipsmall Limited consists of a professional team with an average of over 10 year of expertise in the distribution of electronic components. Based in Hongkong, we have already established firm and mutual-benefit business relationships with customers from,Europe,America and south Asia,supplying obsolete and hard-to-find components to meet their specific needs.

With the principle of "Quality Parts,Customers Priority,Honest Operation,and Considerate Service",our business mainly focus on the distribution of electronic components. Line cards we deal with include Microchip,ALPS,ROHM,Xilinx,Pulse,ON,Everlight and Freescale. Main products comprise IC,Modules,Potentiometer,IC Socket,Relay,Connector.Our parts cover such applications as commercial,industrial, and automotives areas.

We are looking forward to setting up business relationship with you and hope to provide you with the best service and solution. Let us make a better world for our industry!



## Contact us

Tel: +86-755-8981 8866 Fax: +86-755-8427 6832

Email & Skype: info@chipsmall.com Web: www.chipsmall.com

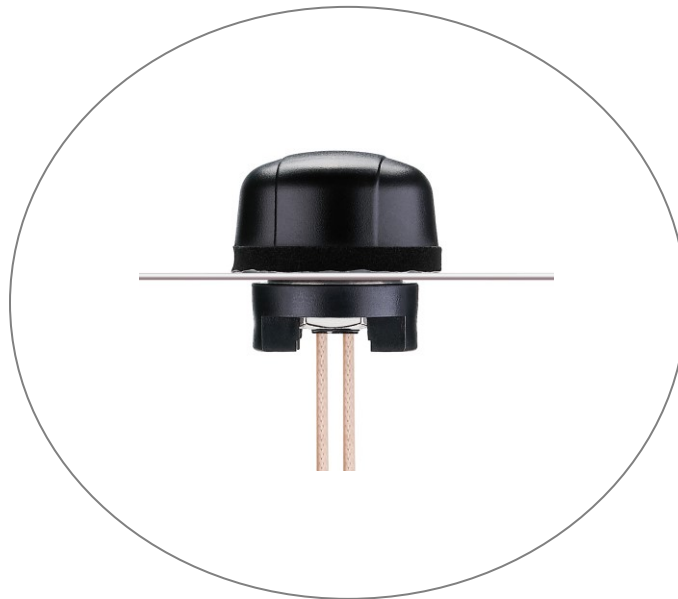
Address: A1208, Overseas Decoration Building, #122 Zhenhua RD., Futian, Shenzhen, China



## SPECIFICATION

- Part No. : **MA515.C.CG.001**
- Product Name : Heavy Duty Screw Mount Antenna  
MIMO Single Band 2.4GHz
- Features : 2.4GHz suitable for  
ISM Bands/ZigBee/WLAN/Bluetooth  
IEEE.802.11n  
High Isolation between Antenna Elements  
UV and vandal resistant PE housing  
IP67 & IP69K compliance  
Height 29mm Diameter 49mm

**RoHS Compliant**



## 1. Introduction

MIMO communication systems are needed in high speed wireless applications. A MIMO (Multiple-Input-Multiple-Output) system uses at least two antenna structures and is more advantageous than single-input single-output (SISO) by increasing channel capacity and reducing transmitting power. MIMO antennas should have compact structure, high radiation efficiency, low envelope correlation, and high isolation between the signal ports.

In small structures (antennas spaced closely), the application of MIMO technology has been restricted by high degree of coupling and spatial correlation between antenna elements due to the limited available space. The isolation between antennas become critical as it can deteriorate the system performance and decreases channel capacity. Taoglas have designed the Hercules MA515 antenna to meet these demanding requirements

The Hercules MA515 MIMO 2.4GHz 3dBi antenna is low profile, heavy-duty, fully IP67 and IP69K waterproof external M2M antenna for use, transportation and remote monitoring applications. This unique omnidirectional 3dBi antenna provide high efficiency and high isolation ( $>20\text{dB}$ ), between antennas elements in a heavy-duty low profile compact structure, delivering powerful MIMO antenna technology for Wi-Fi 802.11n.

The antenna screws down permanently onto a roof or metal panel and can be pole or wall-mounted. The two antenna elements are vertically polarized, matching well with the polarization of most wireless routers antennas. An envelope correlation co-efficiency of only 0.2 ensures good performance with the MIMO module.

For industries such as remote monitoring, smart meter systems, construction equipment, public safety at only 29mm high, the Hercules MA515 MIMO antenna provides an unobtrusive, robust, rugged antenna that is durable even in extreme environments.

## 2. Specification

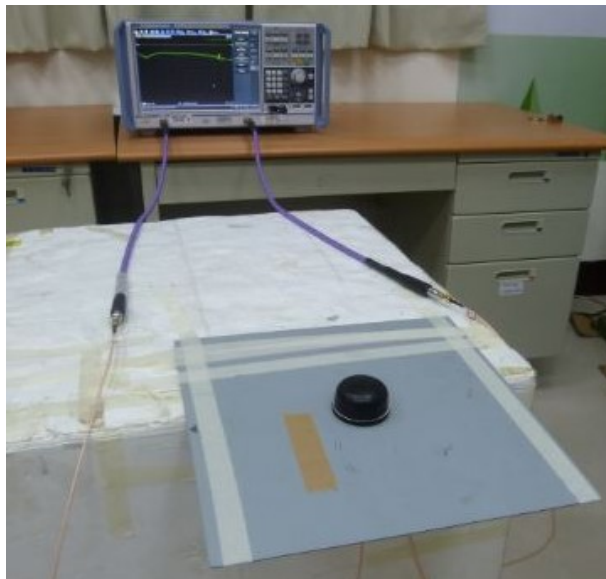
Antenna Hercules MA515 MIMO		
ELECTRICAL		
	Antenna 1	Antenna 2
Operation Frequency (GHz)	2.4~2.5	2.4~2.5
Polarization	Linear	Linear
Impedance (ohms)	50	50
Min Isolation (dB)	-25	-25
Max VSWR	2.0:1	2.0:1
Max Return Loss (dB)	-10	-10
Peak Gain (dBi)	3.0	3.0
Efficiency (%)	56	56
Average Gain (dB)	-2.5	-2.5
Radiation Properties	Omni	Omni
Max Input Power	2W max	
MECHANICAL		
Dimensions (mm)	Height=29 Diameter=49	
Cable	1M RG316- Fully Customizable	
Casing	UV Resistant PC	
Base and Thread	Nickel plated Zinc Alloy/Steel	
Weather proof gasket	CR4305 foam with 3M9448WC double-side adhesive	
Connector	RP-SMA Male Fully Customizable	
Tread Diameter (mm)	18	
Sealant	Rubber Stopper	
ENVIRONMENTAL		
Protection	IP67 & IP69K	
Corrosion	5% NACI for 48hrs- Nickel plated steel base and thread	
Temperature Range	-40°C to +85°C	
Thermal Shock	100 cycles -40°C to +85°C	
Humidity	Non-condensing 65°C 95% RH	
Shock (Drop Test)	1m drop on concrete 6 axes	

\* The Hercules MA515 MIMO antenna performance was measured with RG316 coaxial cable at 1 meter cable length on a 30x30 cm ground plane.

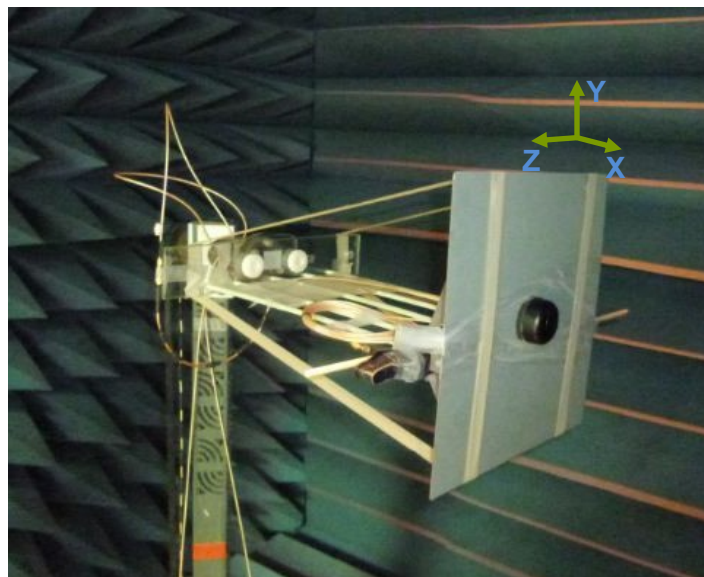


## 3. Antenna Characteristics

### 3.1 Test set-up



**Figure 1.** Impedance measurements.



**Figure 2.** Peak gain, efficiency and radiation pattern measurements.

### 3.2 Return Loss

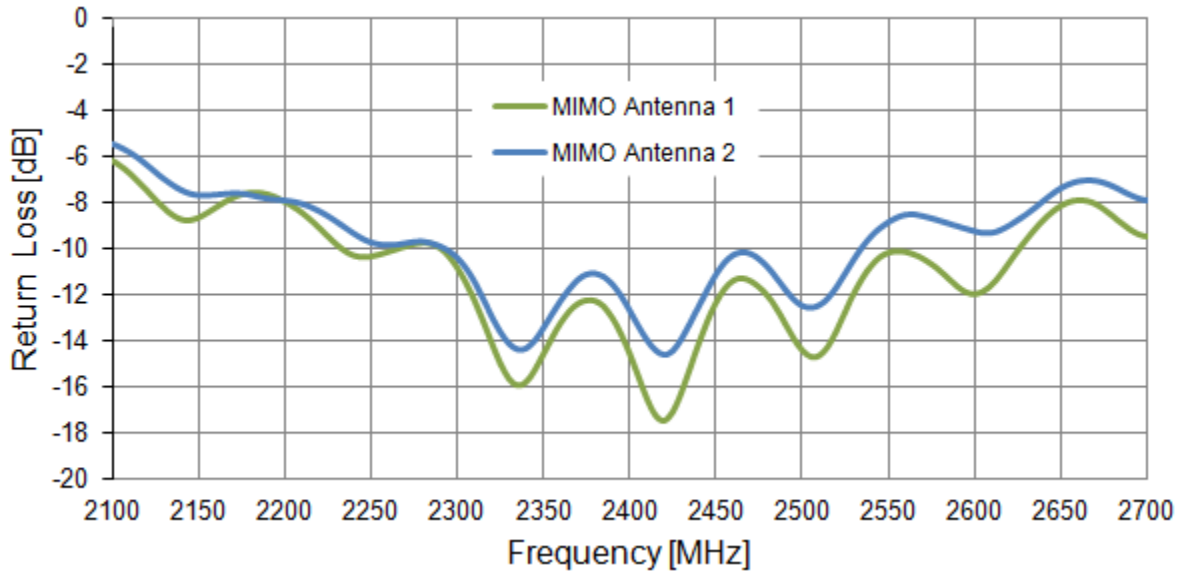


Figure 3. Return loss of the Hercules MA515 MIMO antenna from 2100 MHz to 2700 MHz.

### 3.3 VSWR

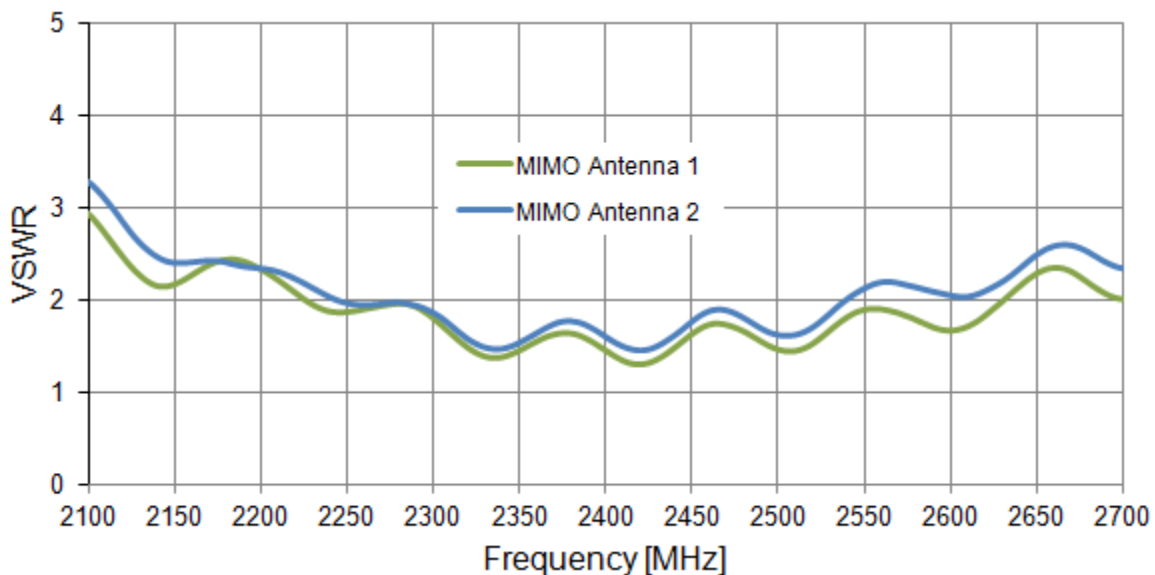
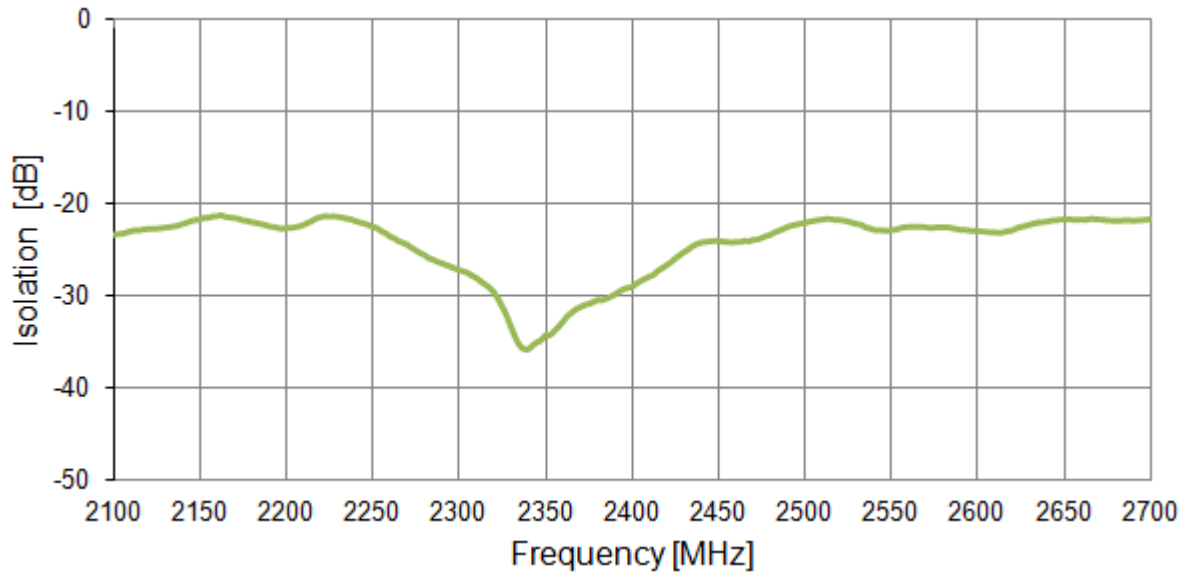


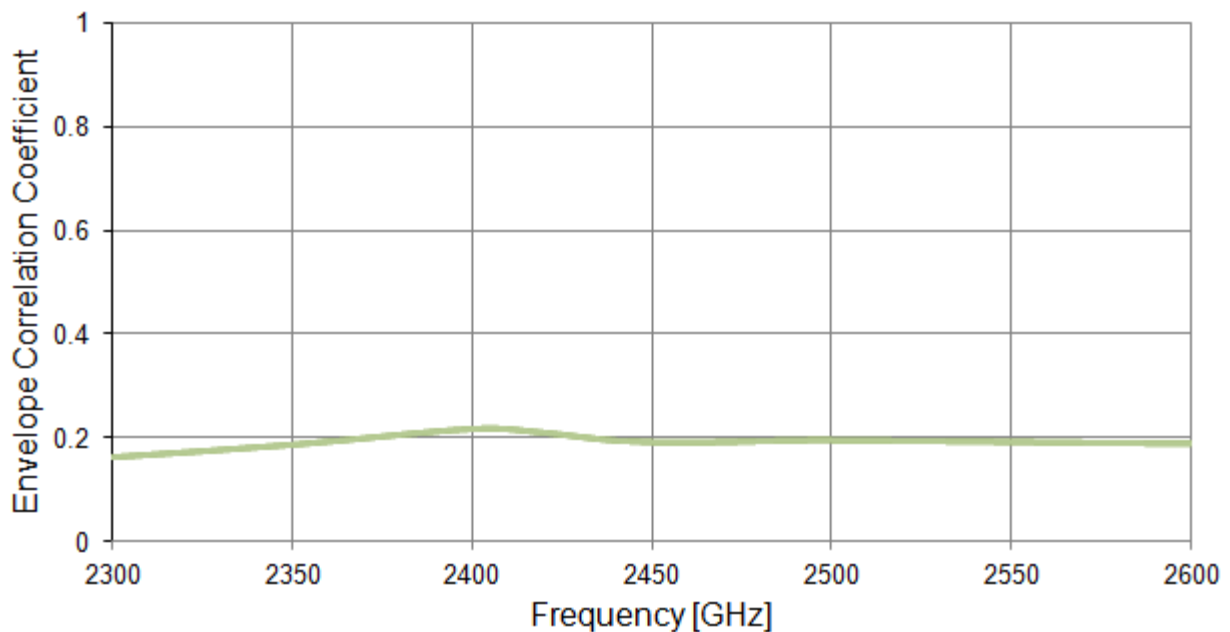
Figure 4. VSWR of the Hercules MA515 MIMO antenna from 2100 MHz to 2700 MHz

### 3.4 Isolation



**Figure 5.** Isolation of the Hercules MA515 MIMO antenna from 2100 MHz to 2700 MHz

### 3.5 Envelope Correlation Coefficient (ECC)



**Figure 6.** ECC of the Hercules MA515 MIMO antenna from 2300 MHz to 2600 MHz.

### 3.6 Efficiency

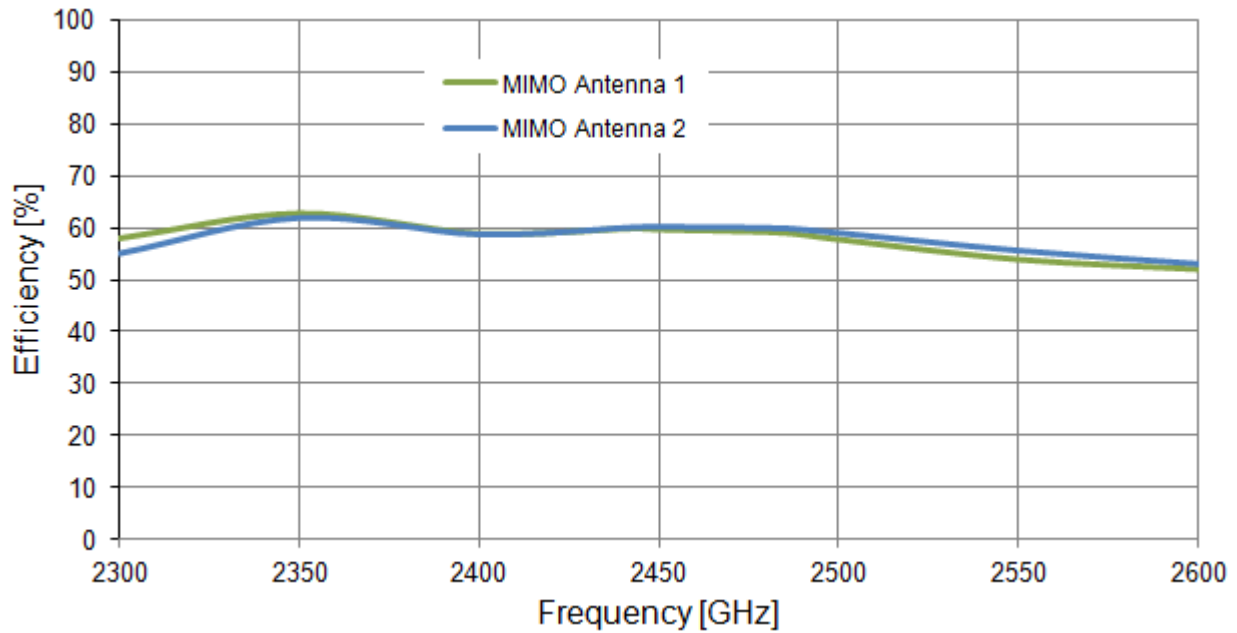


Figure 7. Efficiency of the Hercules MA515 MIMO antenna from 2300 MHz to 2600 MHz.

### 3.7 Peak Gain

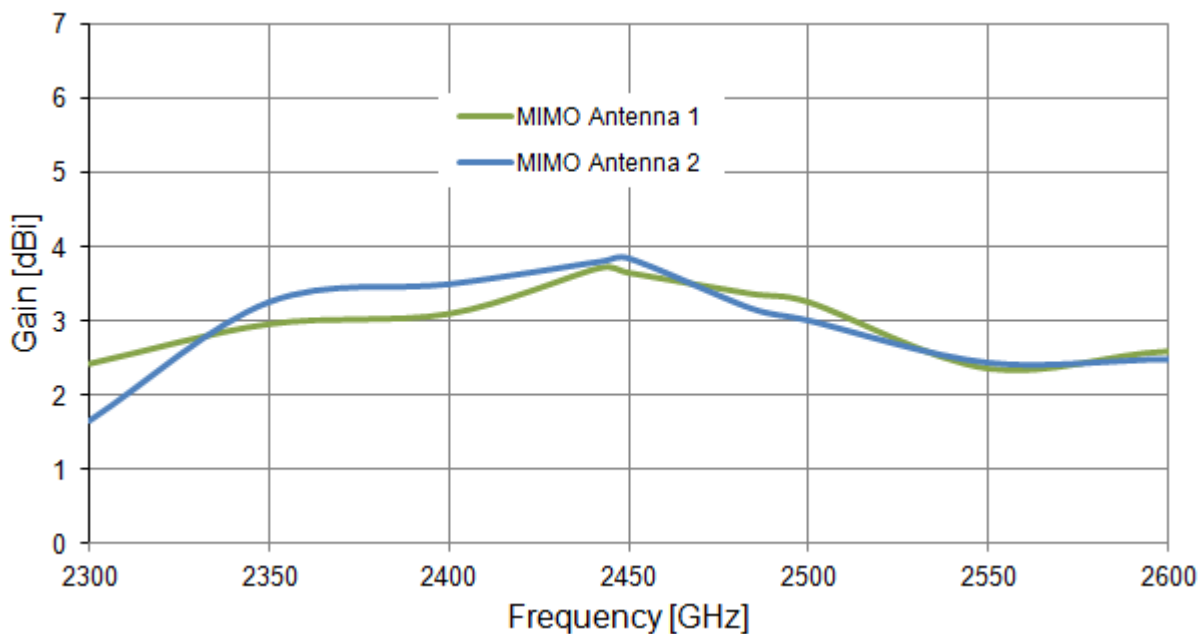


Figure 8. Peak Gain of the Hercules MA515 MIMO antenna from 2300 MHz to 2600 MHz.



### 3.8 Average Gain

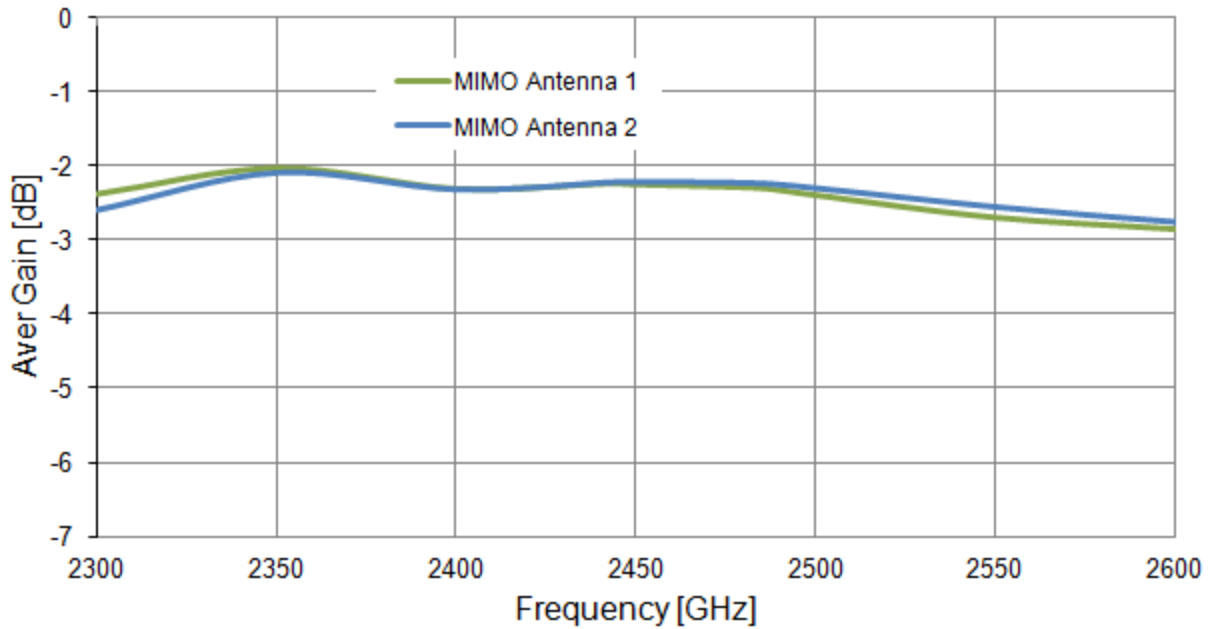


Figure 9. Average Gain of the Hercules MA515 MIMO antenna from 2300 MHz to 2600 MHz.

### 3.9 3D Radiation Patterns

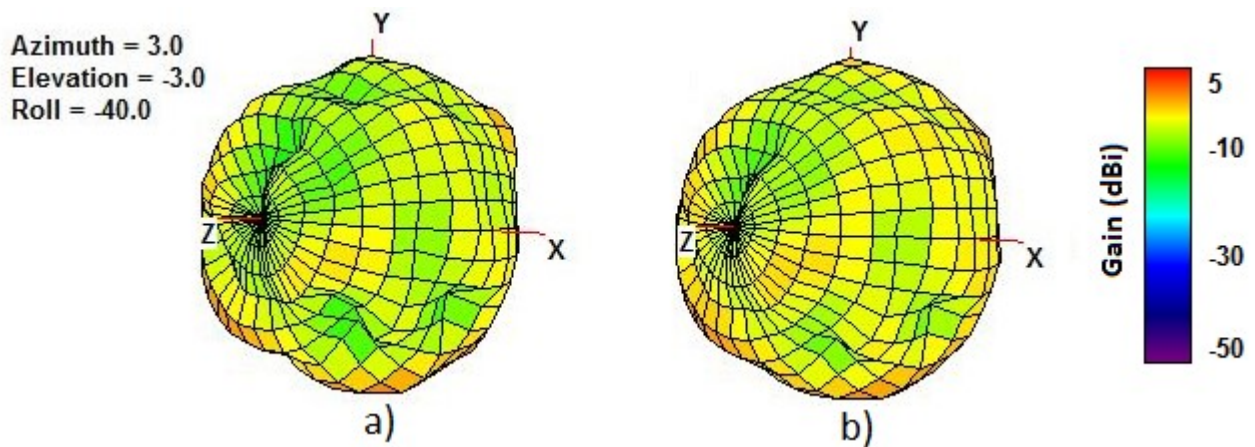
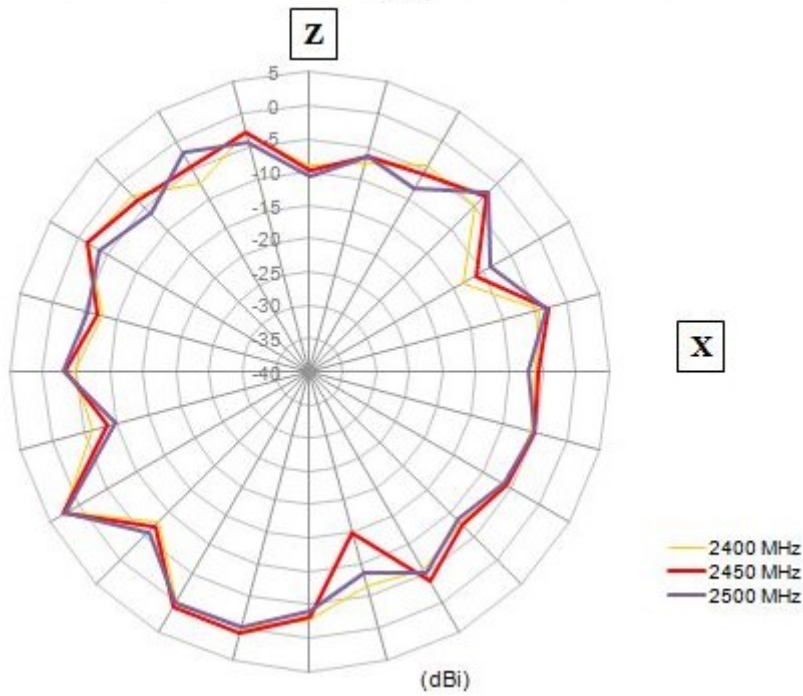
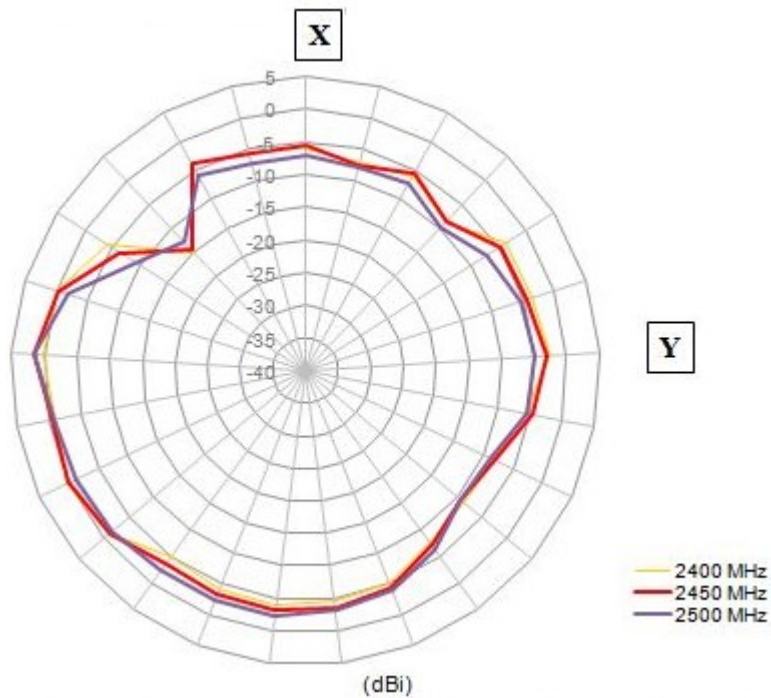
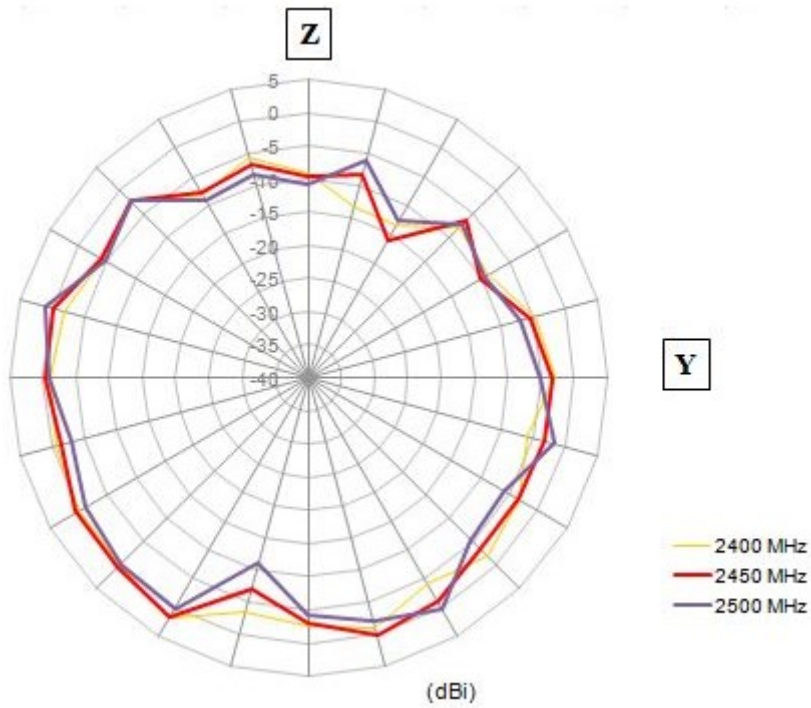


Figure 10. 3D Radiation Pattern at 2450 MHz of the MA515 Antenna, a) Antenna 1, b) Antenna 2

### 3.10 2D Radiation Patterns

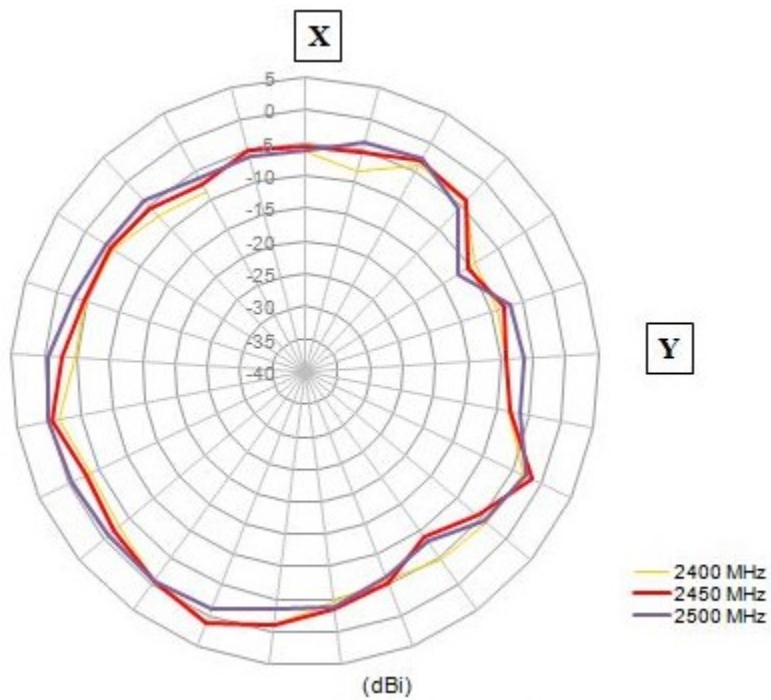
#### 3.10.1 MIMO Antenna 1 2400 MHz Band

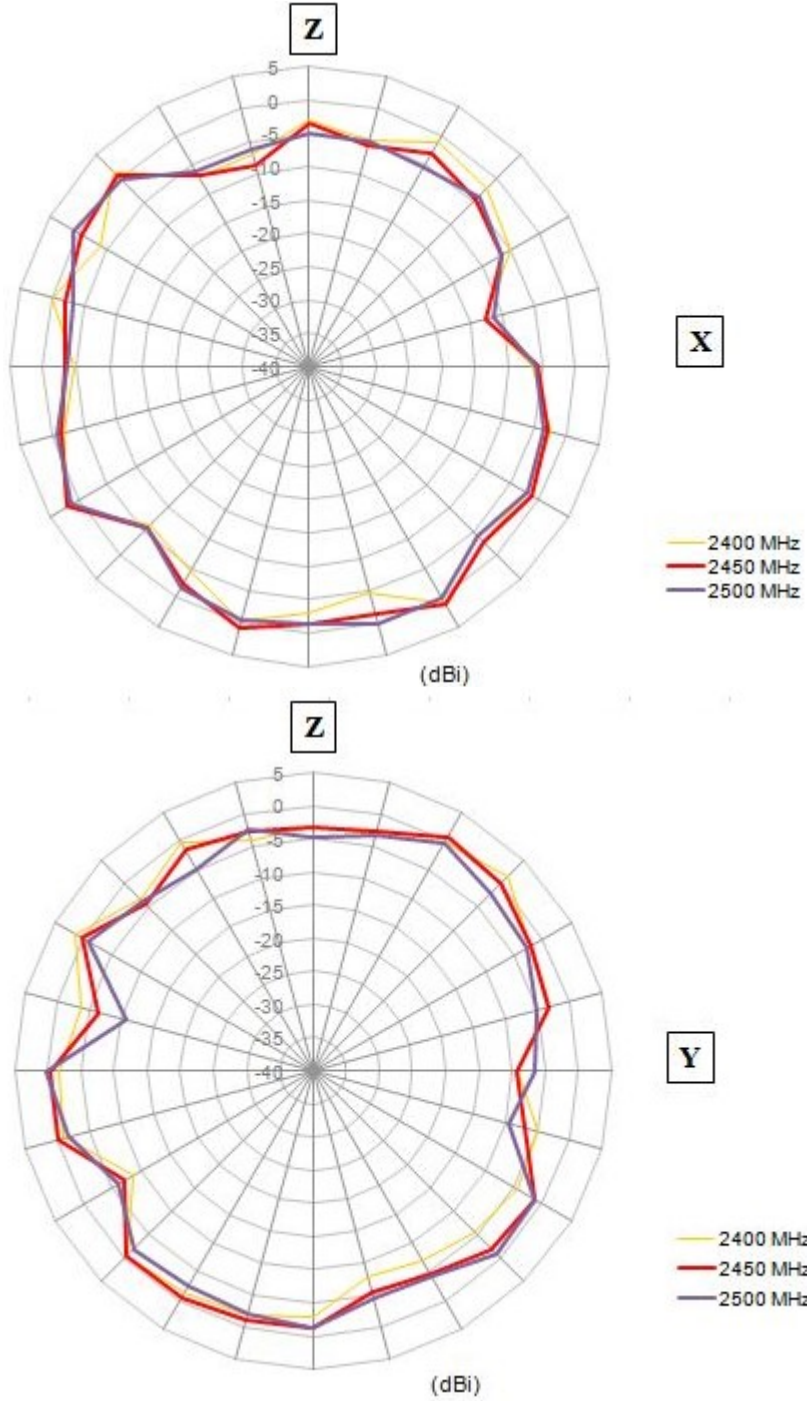




**Figure 11.** 2D Radiation Pattern at 2400MHz band

### 3.10.2 MIMO Antenna 2 2400 MHz Band





**Figure 12.** 2D Radiation Pattern at 2400MHz band



## 4. Antenna Drawing

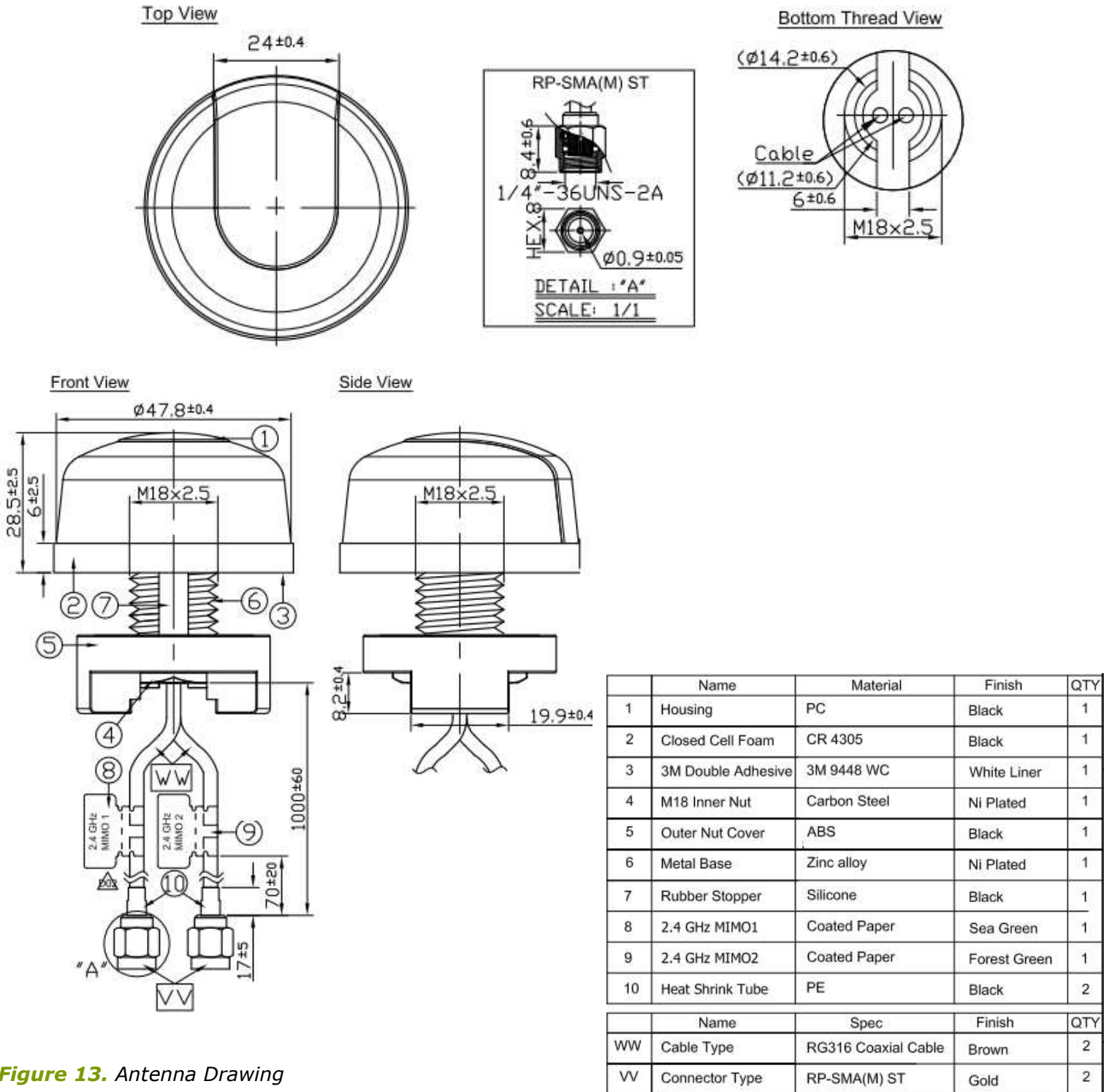
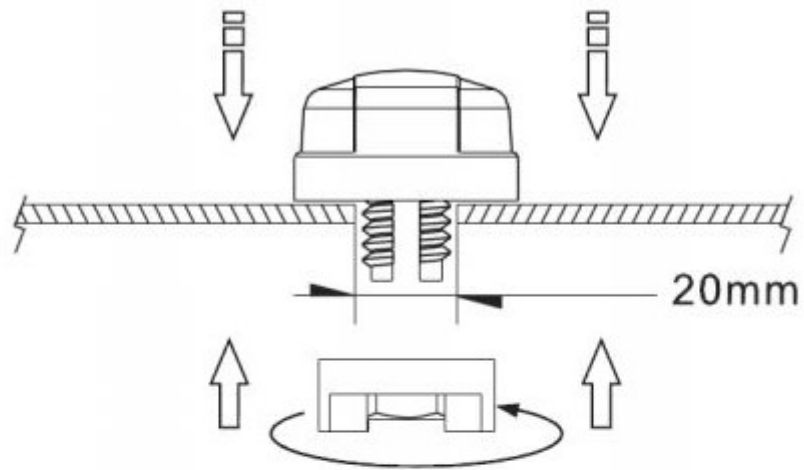


Figure 13. Antenna Drawing



## 5. Installation

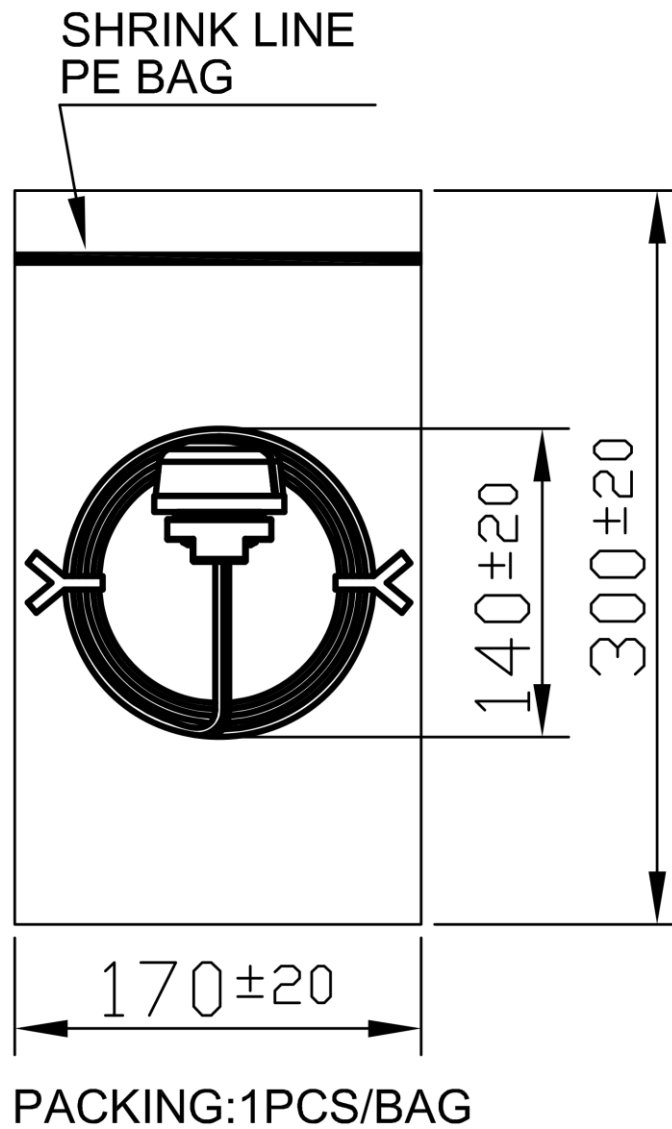


Recommended torque for mounting is 95Nm or 70ftlbs  
 Maximum torque for mounting is 135.6Nm or 100ft lbs



**Figure 14.** Installation

## 6. Packaging





Taoglas makes no warranties based on the accuracy or completeness of the contents of this document and reserves the right to make changes to specifications and product descriptions at any time without notice. Taoglas reserves all rights to this document and the information contained herein.

Reproduction, use or disclosure to third parties without express permission is strictly prohibited.

Copyright © Taoglas Ltd.