



Chipsmall Limited consists of a professional team with an average of over 10 year of expertise in the distribution of electronic components. Based in Hongkong, we have already established firm and mutual-benefit business relationships with customers from,Europe,America and south Asia,supplying obsolete and hard-to-find components to meet their specific needs.

With the principle of "Quality Parts,Customers Priority,Honest Operation,and Considerate Service",our business mainly focus on the distribution of electronic components. Line cards we deal with include Microchip,ALPS,ROHM,Xilinx,Pulse,ON,Everlight and Freescale. Main products comprise IC,Modules,Potentiometer,IC Socket,Relay,Connector.Our parts cover such applications as commercial,industrial, and automotives areas.

We are looking forward to setting up business relationship with you and hope to provide you with the best service and solution. Let us make a better world for our industry!



Contact us

Tel: +86-755-8981 8866 Fax: +86-755-8427 6832

Email & Skype: info@chipsmall.com Web: www.chipsmall.com

Address: A1208, Overseas Decoration Building, #122 Zhenhua RD., Futian, Shenzhen, China



Low Noise Amplifier 22 - 38 GHz

Rev. V2

Features

- 19 dB Small Signal Gain
- 2.5 dB Noise Figure
- Single 3.3 V Bias
- Lead-Free 3 mm 16-Lead PQFN Package
- 100% RF Tested
- RoHS⁺ Compliant

Description

The MAAL-011111 is a three stage 22 - 38 GHz GaAs MMIC low noise amplifier. This device has a small signal gain of 19 dB with a noise figure of 2.5 dB.

This lead-free, 3 mm QFN package requires only a single positive bias supply. The device uses MACOM's GaAs transistor technology, ensuring high repeatability and uniformity.

The device is well suited to multiple receiver applications which require broadband performance with simple bias requirements and the ease of volume manufacturing with 3 mm QFN packaging.

Ordering Information^{1,2}

Part Number	Package
MAAL-011111-TR0500	500 pc reel
MAAL-011111-TR1000	1K pc reel
MAAL-011111-000SMB	Sample Evaluation board

1. Reference Application Note M513 for reel size information.
2. All sample boards include 5 loose parts.

Functional Block Diagram

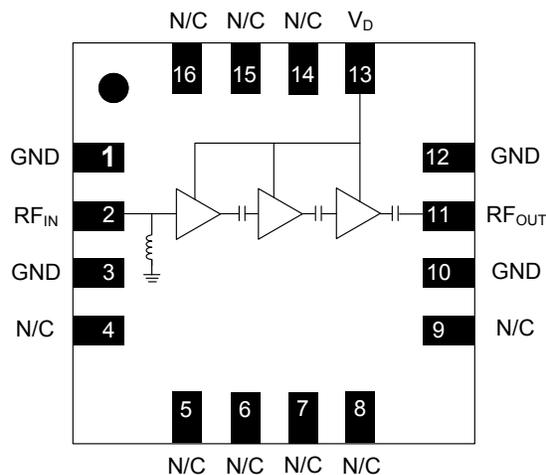

Pin Configuration

Pin No.	Pin Name	Description
1	GND	Ground
2	RF _{IN}	RF Input
3	GND	Ground
4-9	N/C	No Connection
10	GND	Ground
11	RF _{OUT}	RF Output
12	GND	Ground
13	V _D	Bias Voltage
14-16	N/C	No Connection
Paddle ³		RF and DC Ground

3. The exposed pad centered on the package bottom must be connected to RF and DC ground.

*Restrictions on Hazardous Substances, European Union Directive 2011/65/EU.

Electrical Specifications: Freq: 22 - 38 GHz, $V_D = 3.3$ V, $T_A = +25^\circ\text{C}$

Parameter	Units	Min.	Typ.	Max.
Small Signal Gain ⁴	dB	17	19	—
Gain Flatness	dB	—	±2	—
Input Return Loss	dB	—	10	—
Output Return Loss	dB	—	13	—
Reverse isolation	dB	—	45	—
Noise Figure	dB	—	2.5	—
Output P1dB	dBm	—	5	—
Supply Current (I_D)	mA	—	55	65

4. Specified over 24-36 GHz

Absolute Maximum Ratings^{5,6}

Parameter	Absolute Max.
Supply Voltage	7 VDC
Supply Current	70 mA
Input Power	12.0 dBm
Storage Temperature	-65°C to +165°C
Operating Temperature	-40°C to +85°C
Channel Temperature ⁷	+150°C

- 5. Exceeding any one or combination of these limits may cause permanent damage to this device.
- 6. MACOM does not recommend sustained operation near these survivability limits.
- 7. Channel temperature directly affects a device's MTTF. It is recommended to keep channel temperature as low as possible to maximize lifetime.

Handling Procedures

Please observe the following precautions to avoid damage:

Static Sensitivity

Gallium Arsenide Integrated Circuits are sensitive to electrostatic discharge (ESD) and can be damaged by static electricity. Proper ESD control techniques should be used when handling these Class 1A devices.

Typical Performance Curves

Gain

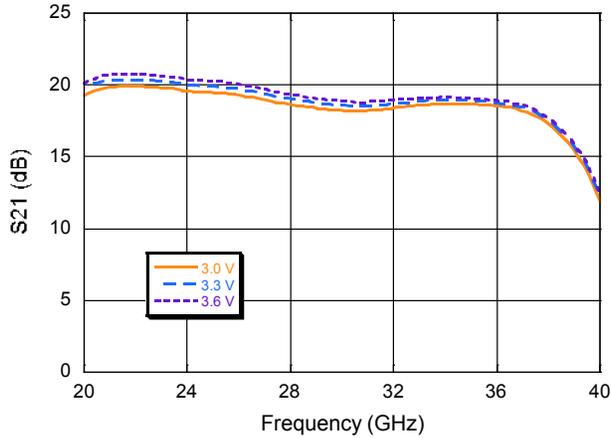

Reverse Isolation

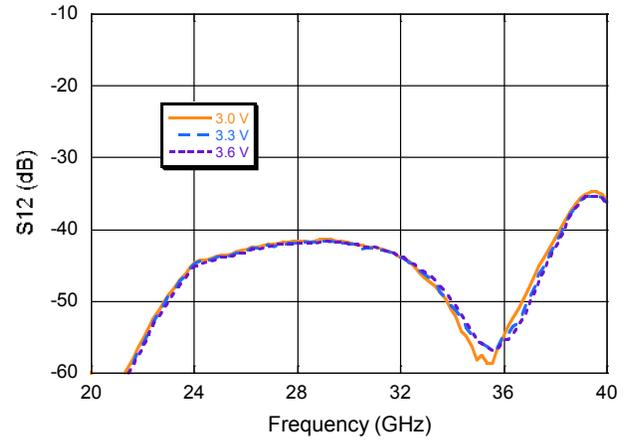

Input Return Loss

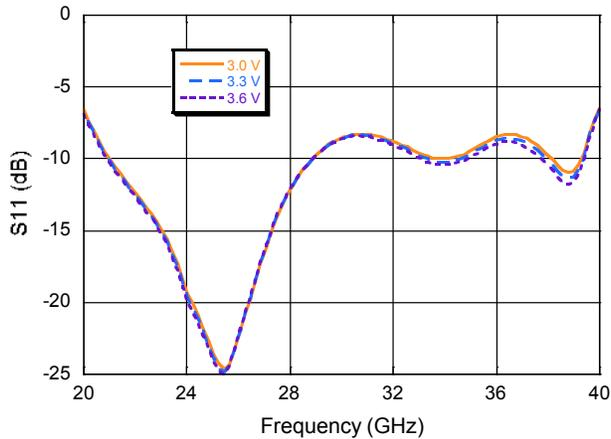

Output Return Loss

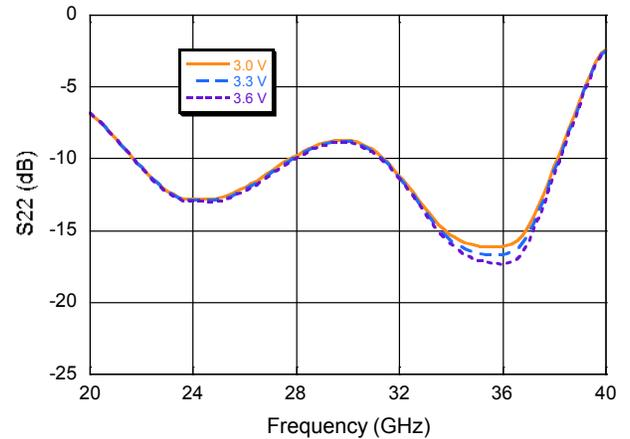

Typical Performance Curves

Noise Figure

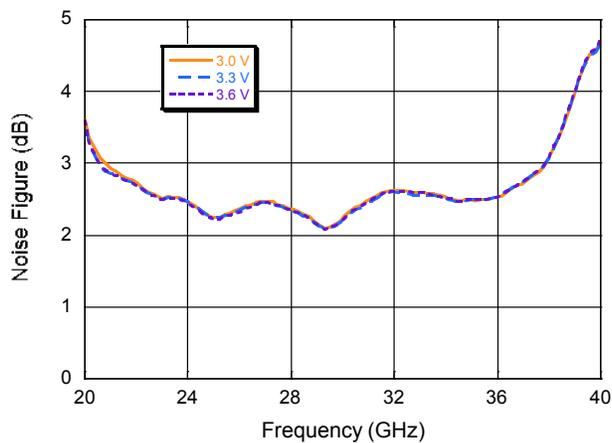

P1dB

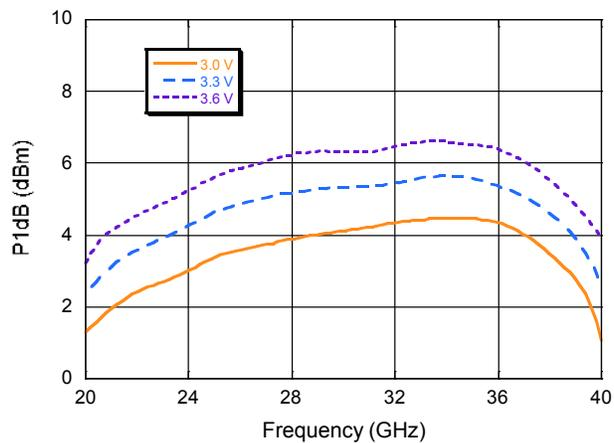

Gain Over Temperature

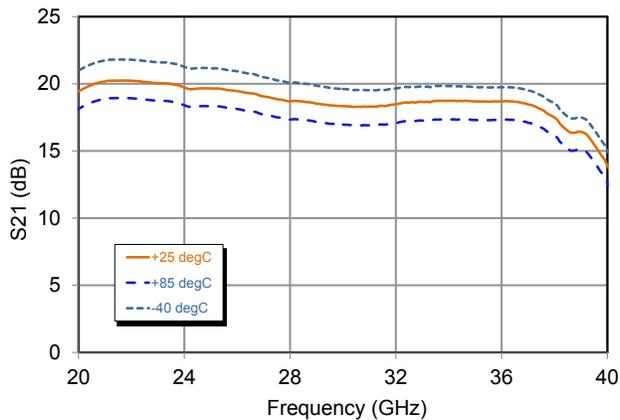

Recommended Board Layout⁸

(DXF file available from website)

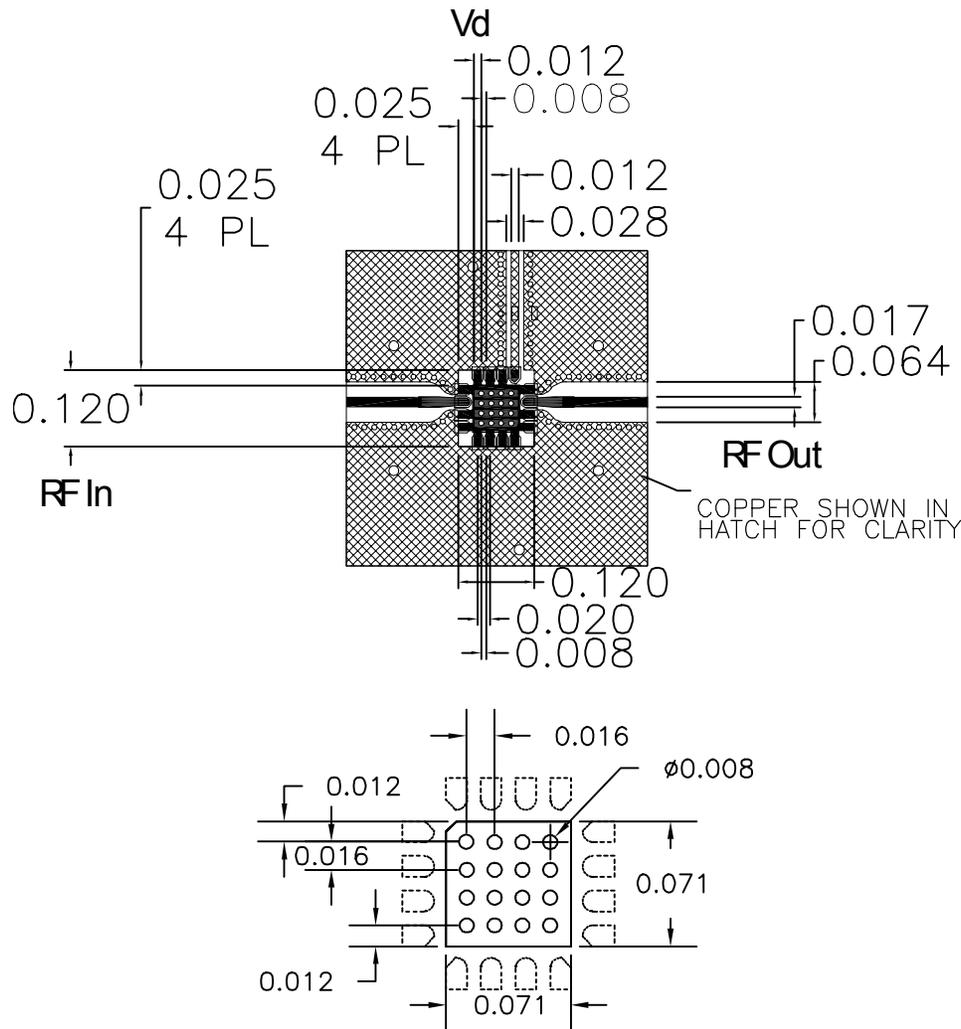

8. Ground plane conductor should be removed under the corners of the package, as shown.

Biasing - The device is operated with a single, positive bias supply. The device performance is insensitive to changes in bias condition; however, gain and power handling can be slightly improved with higher bias conditions without significantly affecting the noise figure performance. Typical biasing conditions within the specified performance ranges are $V_D = 3\text{ V}$, 50 mA, $V_D = 3.3\text{ V}$, 55 mA, $V_D = 3.6\text{ V}$, 60 mA.

Lead-Free 3 mm 16-Lead PQFN†

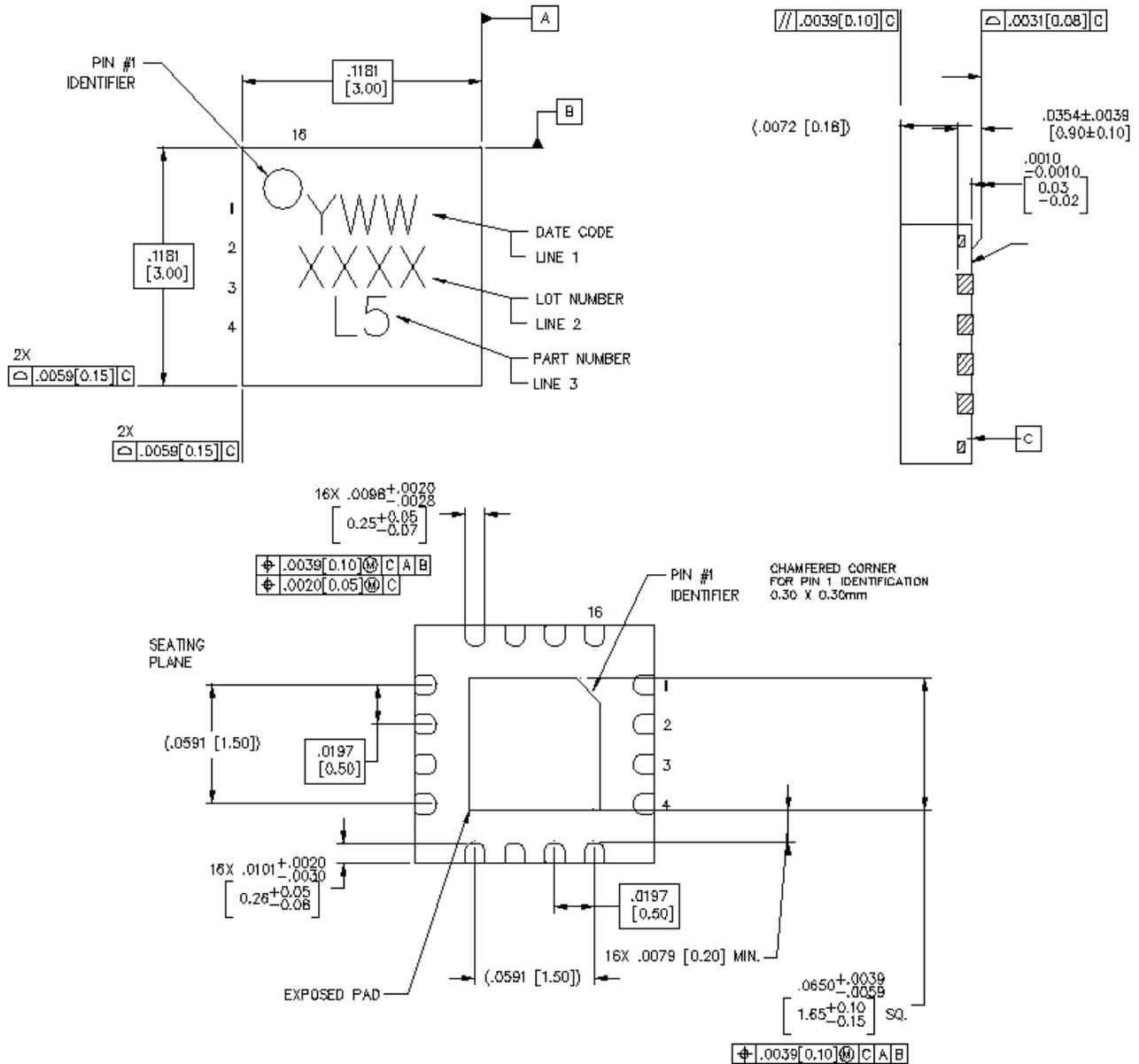

† Reference Application Note S2083 for lead-free solder reflow recommendations.
Meets JEDEC moisture sensitivity level 1 requirements.
Plating is 100% matte tin plating over copper

M/A-COM Technology Solutions Inc. All rights reserved.

Information in this document is provided in connection with M/A-COM Technology Solutions Inc ("MACOM") products. These materials are provided by MACOM as a service to its customers and may be used for informational purposes only. Except as provided in MACOM's Terms and Conditions of Sale for such products or in any separate agreement related to this document, MACOM assumes no liability whatsoever. MACOM assumes no responsibility for errors or omissions in these materials. MACOM may make changes to specifications and product descriptions at any time, without notice. MACOM makes no commitment to update the information and shall have no responsibility whatsoever for conflicts or incompatibilities arising from future changes to its specifications and product descriptions. No license, express or implied, by estoppel or otherwise, to any intellectual property rights is granted by this document.

THESE MATERIALS ARE PROVIDED "AS IS" WITHOUT WARRANTY OF ANY KIND, EITHER EXPRESS OR IMPLIED, RELATING TO SALE AND/OR USE OF MACOM PRODUCTS INCLUDING LIABILITY OR WARRANTIES RELATING TO FITNESS FOR A PARTICULAR PURPOSE, CONSEQUENTIAL OR INCIDENTAL DAMAGES, MERCHANTABILITY, OR INFRINGEMENT OF ANY PATENT, COPYRIGHT OR OTHER INTELLECTUAL PROPERTY RIGHT. MACOM FURTHER DOES NOT WARRANT THE ACCURACY OR COMPLETENESS OF THE INFORMATION, TEXT, GRAPHICS OR OTHER ITEMS CONTAINED WITHIN THESE MATERIALS. MACOM SHALL NOT BE LIABLE FOR ANY SPECIAL, INDIRECT, INCIDENTAL, OR CONSEQUENTIAL DAMAGES, INCLUDING WITHOUT LIMITATION, LOST REVENUES OR LOST PROFITS, WHICH MAY RESULT FROM THE USE OF THESE MATERIALS.

MACOM products are not intended for use in medical, lifesaving or life sustaining applications. MACOM customers using or selling MACOM products for use in such applications do so at their own risk and agree to fully indemnify MACOM for any damages resulting from such improper use or sale.