



Chipsmall Limited consists of a professional team with an average of over 10 year of expertise in the distribution of electronic components. Based in Hongkong, we have already established firm and mutual-benefit business relationships with customers from,Europe,America and south Asia,supplying obsolete and hard-to-find components to meet their specific needs.

With the principle of “Quality Parts,Customers Priority,Honest Operation,and Considerate Service”,our business mainly focus on the distribution of electronic components. Line cards we deal with include Microchip,ALPS,ROHM,Xilinx,Pulse,ON,Everlight and Freescale. Main products comprise IC,Modules,Potentiometer,IC Socket,Relay,Connector.Our parts cover such applications as commercial,industrial, and automotives areas.

We are looking forward to setting up business relationship with you and hope to provide you with the best service and solution. Let us make a better world for our industry!



Contact us

Tel: +86-755-8981 8866 Fax: +86-755-8427 6832

Email & Skype: info@chipsmall.com Web: www.chipsmall.com

Address: A1208, Overseas Decoration Building, #122 Zhenhua RD., Futian, Shenzhen, China



Broadband Low Noise Amplifier 2 - 18 GHz

Rev. V1

Features

- Gain: 21 dB @ 10 GHz
- Noise Figure: 1.4 dB @ 10 GHz
- Output P1dB: 14 dBm
- Single Voltage Bias: 3.3 V to 5 V
- Power Down Capability
- Lead-Free 2 mm 8-lead PDFN Package
- Halogen-Free “Green” Mold Compound
- RoHS* Compliant

Description

The MAAL-011130 is an easy-to-use, broadband, low noise amplifier with 19 dB typical gain from 2 to 18 GHz. The input and output are fully matched to 50 Ω with typical return loss >10 dB. Third order linearity (OIP3) is typically 23 dBm and reverse isolation is >35 dB.

Single voltage (V_{DD} from +3.3 V to +5 V) operation is achieved using an external resistor, R_B , between pin 4 and V_{DD} . The value of R_B will set the drain current. Alternatively, the application of a bias voltage (V_B) to pin 4 allows for the adjustment of drain current from 5 mA to 80 mA and provides power down capability, achieved by applying $V_B < 0.2$ V. See biasing information on pages 3 and 4.

The MAAL-011130 is housed in a lead-free 2 mm 8-lead PDFN package compatible with standard pick and place assembly equipment.

The MAAL-011130 is well suited to multiple applications such as X-Band satellite communication receivers and wideband A&D systems.

Ordering Information^{1,2}

Part Number	Package
MAAL-011130	Bulk
MAAL-011130-TR3000	3000 piece reel
MAAL-011130-SMB	Sample Board

1. Reference Application Note M513 for reel size information.
2. All sample boards include 3 loose parts.

Functional Schematic

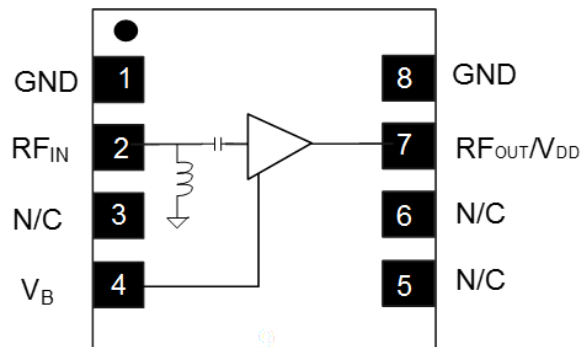

Pin Configuration^{3,4}

Pin No.	Pin Name	Description
1	GND	DC + RF ground
2	RF _{IN}	RF input
3	N/C	No connection
4	V _B	Bias control voltage
5	N/C	No connection
6	N/C	No connection
7	RF _{OUT} / V _{DD}	RF output and V _{DD}
8	GND	DC + RF ground
	Paddle	DC + RF ground

3. MACOM recommends connecting unused package pins to ground.
4. The exposed pad centered on the package bottom must be connected to RF and DC ground.

* Restrictions on Hazardous Substances, European Union Directive 2011/65/EU.

Broadband Low Noise Amplifier 2 - 18 GHz

Rev. V1

Electrical Specifications: $T_A = +25^\circ\text{C}$, $V_{DD} = 5\text{ V}$, $V_B = 0.9\text{ V}^5$, $Z_0 = 50\ \Omega$

Parameter	Test Conditions	Units	Min.	Typ.	Max.
Gain	2 GHz	dB	19	27	—
	6 GHz			23	
	10 GHz			21	
	14 GHz			19	
	18 GHz			14	
Output P1dB	2 GHz	dBm	—	12	—
	6 GHz			13	
	10 GHz			14	
	14 GHz			15	
	18 GHz			15	
Noise Figure	2 GHz	dB	—	2.1	1.8
	6 GHz			1.2	
	10 GHz			1.4	
	14 GHz			1.8	
	18 GHz			2.9	
Output IP3	$P_{IN} = -22\text{ dBm/tone}$ (10 MHz Tone Spacing)		dBm	—	—
	2 GHz	18			
	6 GHz	20			
	10 GHz	24			
	14 GHz	25			
18 GHz	24				
Input Return Loss	$P_{IN} = -20\text{ dBm}$	dB	—	10	—
Output Return Loss	$P_{IN} = -20\text{ dBm}$	dB	—	10	—
Isolation	$P_{IN} = -20\text{ dBm}$	dB	—	35	—
Bias Current	—	mA	—	76	90

5. For single voltage operation, refer to typical R_B values and biasing information on pages 3 and 4.

Absolute Maximum Ratings^{6,7}

Parameter	Absolute Maximum
Input Power	10 dBm
Operating Voltage	7 V
Operating Temperature	-40 °C to +85 °C
Storage Temperature	-65 °C to +150 °C
Junction Temperature ^{8,9}	+150 °C

6. Exceeding any one or combination of these limits may cause permanent damage to this device.
7. MACOM does not recommend sustained operation near these survivability limits.
8. Operating at nominal conditions with $T_J \leq +150^\circ\text{C}$ will ensure $\text{MTTF} > 1 \times 10^6$ hours.
9. Junction Temperature (T_J) = $T_C + \Theta_{jc} * (V * I)$.
Typical thermal resistance (Θ_{jc}) = 126°C/W .
 - a) $T_C = +25^\circ\text{C}$,
 $T_J = 76^\circ\text{C @ 5 V, 80 mA}$
 - b) $T_C = +85^\circ\text{C}$,
 $T_J = 136^\circ\text{C @ 5 V, 80 mA}$

Handling Procedures

Please observe the following precautions to avoid damage:

Static Sensitivity

Gallium Arsenide Integrated Circuits are sensitive to electrostatic discharge (ESD) and can be damaged by static electricity. Proper ESD control techniques should be used when handling these Class 1A devices.

Application Information

The MAAL-011130 is designed for simple implementation with high performance. The ultra small size, fully matched, and simple bias application allows easy placement on system boards. It has a shunt inductor connected to ground on the input for ESD protection. For this reason, an input DC blocking capacitor is required if DC voltage is present on the input.

Bias Adjust Using V_B

Pin 4 can be connected to a separate voltage source to achieve the desired I_{DD} . The amplifier will be powered down by applying a V_B of 0.2 V or less.

The following tables show typical total drain current ($I_{D_TOTAL} = I_{D_BIAS} + I_{DD}$, where I_{D_BIAS} is the current drawn by the V_B pin and I_{DD} is the drain current) versus bias voltage (V_B) values for V_{DD} voltages of 5.0 V and 3.3 V. Also shown in each case is a typical value of R_B required to set I_{DD} if using a single supply (see Single Bias Operation information on page 4).

$V_{DD} = 3.3 \text{ V}$				
V_B (V)	I_{D_TOTAL} (mA)	I_{D_BIAS} (mA)	I_{DD} (mA)	R_B (k Ω)
0.6	32.9	1.2	31.7	2.2
0.7	44.9	2.3	42.6	1.1
0.8	56.7	3.5	53.3	0.7
0.9	67.4	4.6	62.8	0.5
1.0	76.4	5.8	70.5	0.4

$V_{DD} = 5 \text{ V}$				
V_B (V)	I_{D_TOTAL} (mA)	I_{D_BIAS} (mA)	I_{DD} (mA)	R_B (k Ω)
0.6	40	1.1	39	4.0
0.7	53	2.3	50	1.9
0.8	65	3.4	62	1.3
0.9	77	4.5	73	0.9
1.0	89	5.8	83	0.7

Sample PCB

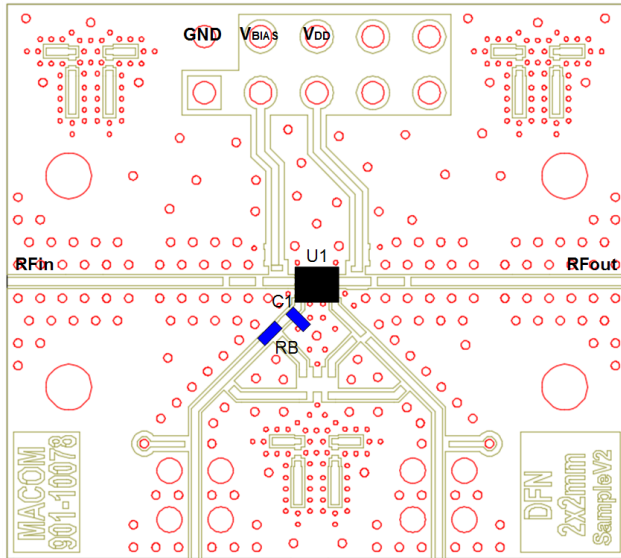

Sample PCB layout

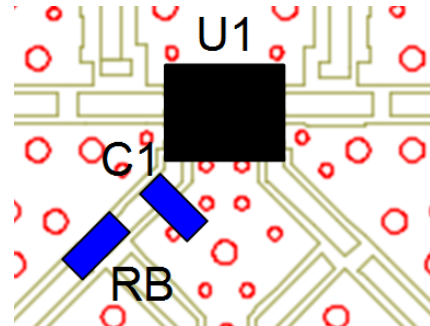

Application Schematic

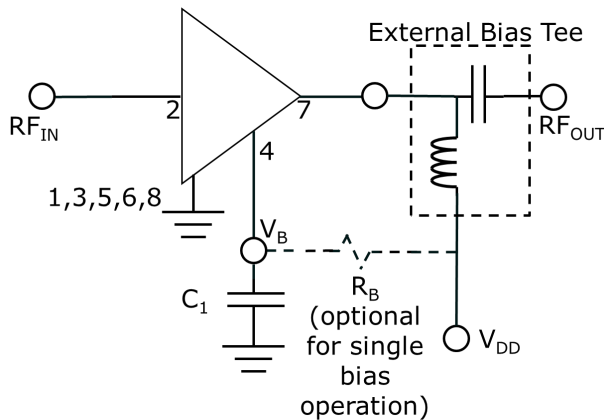

Single Bias Operation

Connecting V_{DD} to pin 4 using an external resistor R_B enables single bias operation of the amplifier, where the value of external resistor R_B can be used to set the desired I_{DD}.

In this configuration, power down mode cannot be used unless a switch is included to connect V_B to ground.

Grounding

It is recommended that the total ground (common mode) inductance not exceed 0.03 nH (30 pH). This is equivalent to placing at least four 8-mil (200- μ m) diameter vias under the device, assuming an 8-mil (200- μ m) thick RF layer to ground.

Parts List

Des	Value	Size	Part Number	Purpose
C1	0.01 μ F	0201	Murata GRM033R70J103KA01D	Bypass
U1	—	2 mm	MACOM MAAL-011130	LNA

Broadband Low Noise Amplifier 2 - 18 GHz

Rev. V1

Typical Performance Curves $V_{DD} = 5\text{ V}$, $V_B = 0.9\text{ V}$

Gain

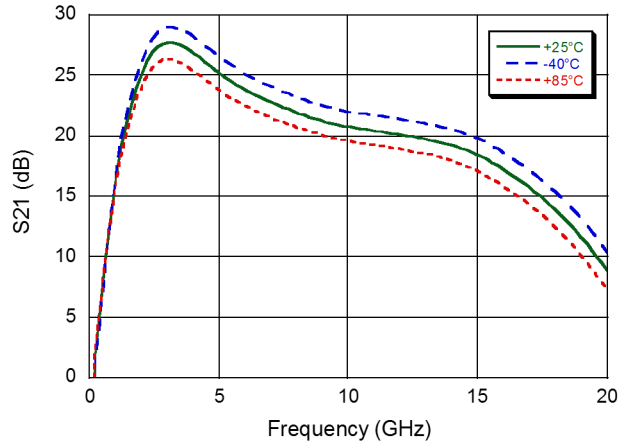

Isolation

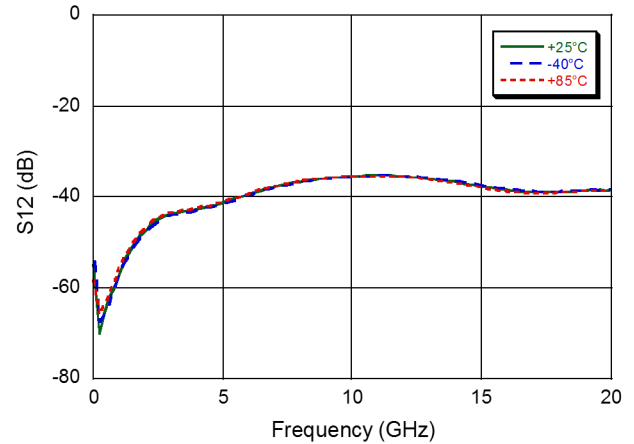

Input Return Loss

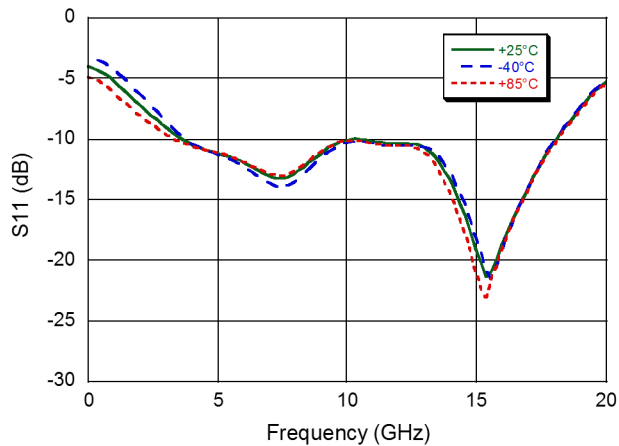

Output Return Loss

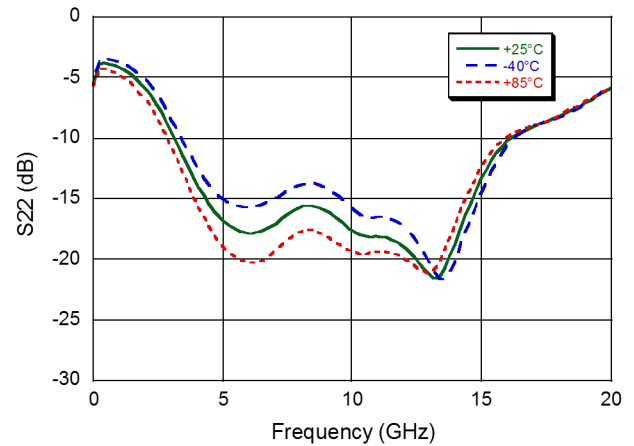

Noise Figure

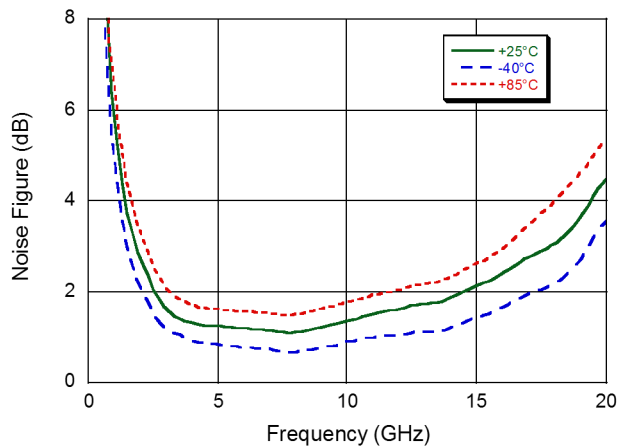

Broadband Low Noise Amplifier 2 - 18 GHz

Rev. V1

Typical Performance Curves $T_A = 25^\circ\text{C}$, $V_{DD} = 3.3\text{ V} \& 5\text{ V}$

Gain

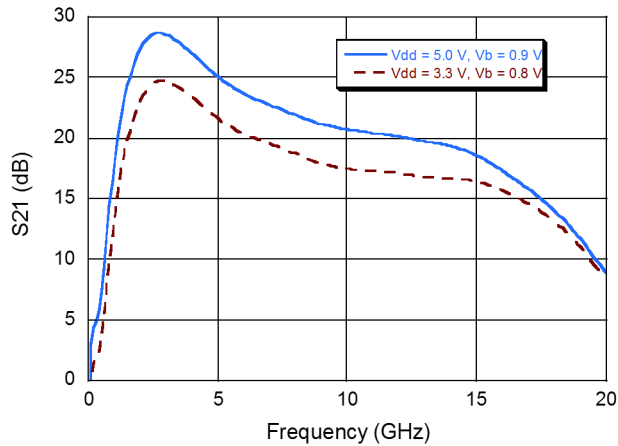

Isolation

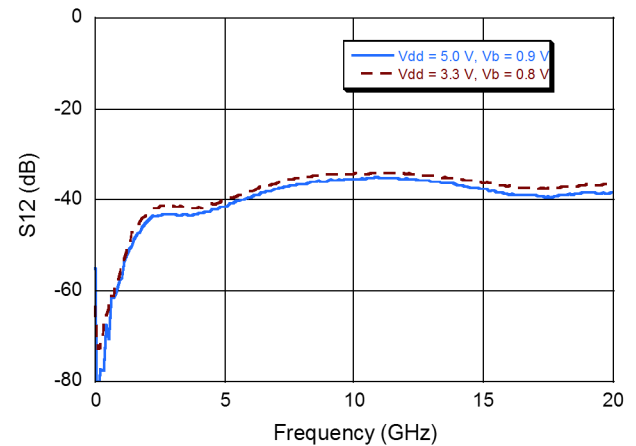

Input Return Loss

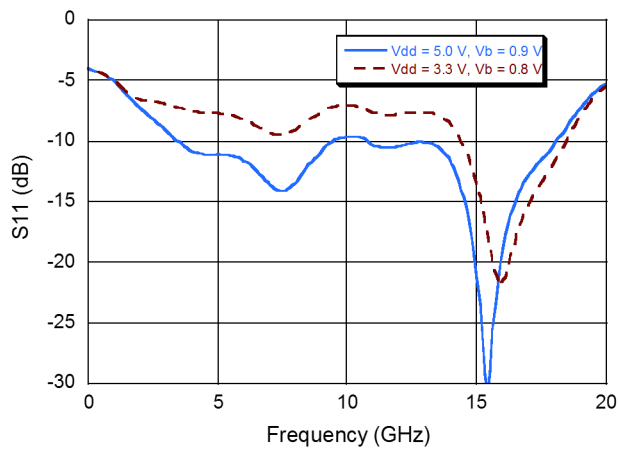

Output Return Loss

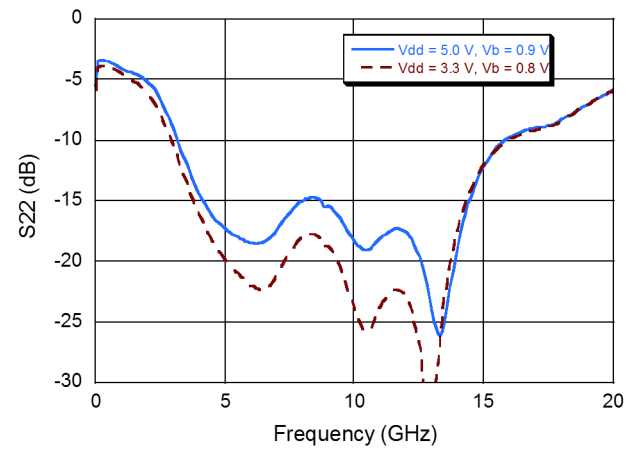

Noise Figure

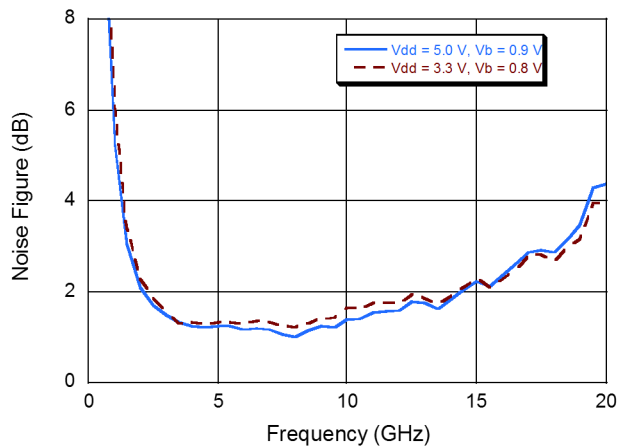

Typical Performance Curves $T_A = 25^\circ\text{C}$, $V_{DD} = 5\text{ V}$ & 3.3 V

Gain vs. V_B for $V_{DD} = 5\text{ V}$

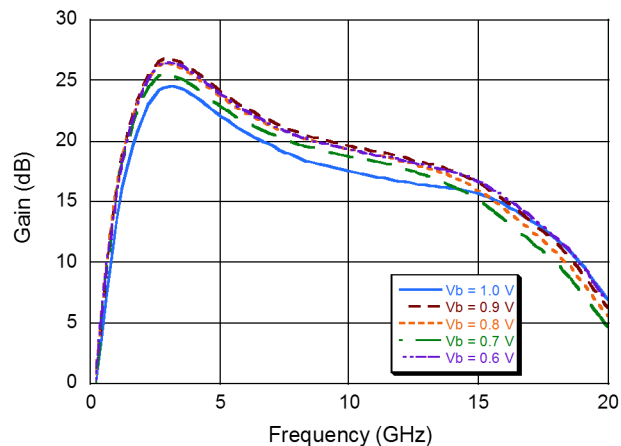

Gain vs. V_B for $V_{DD} = 3.3\text{ V}$

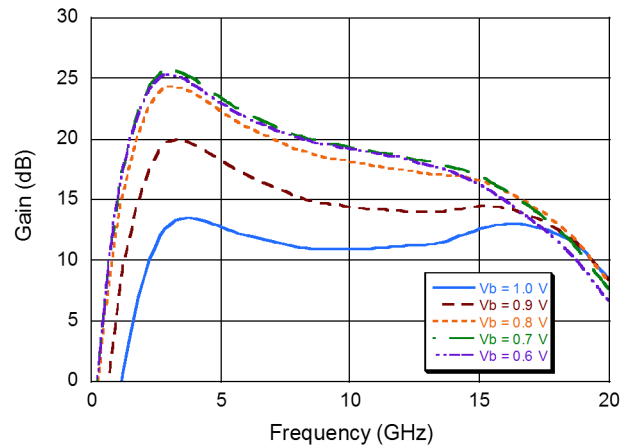

Broadband Low Noise Amplifier 2 - 18 GHz

Rev. V1

Typical Output IP3 Curves $V_{DD} = 5\text{ V}$ and 3.3 V

Output IP3 @ $T_A = 25^\circ\text{C}$, $V_{DD} = 5\text{ V}$

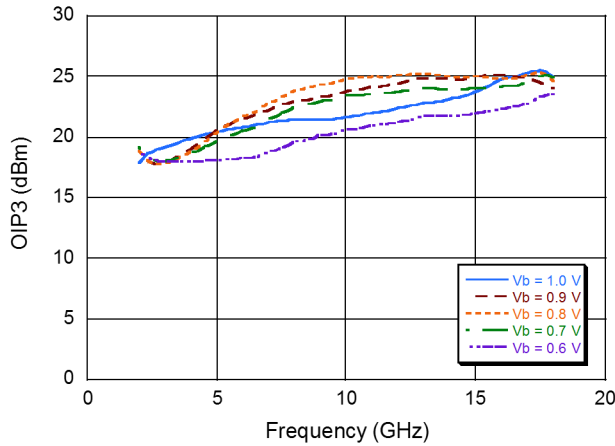

Output IP3 @ $T_A = 25^\circ\text{C}$, $V_{DD} = 3.3\text{ V}$

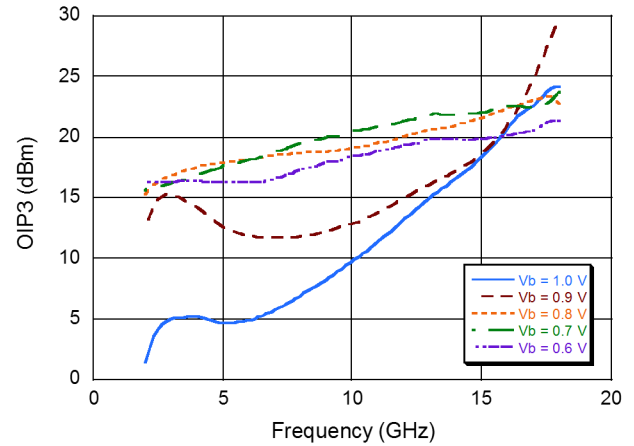

Output IP3 @ $T_A = -40^\circ\text{C}$, $V_{DD} = 5\text{ V}$

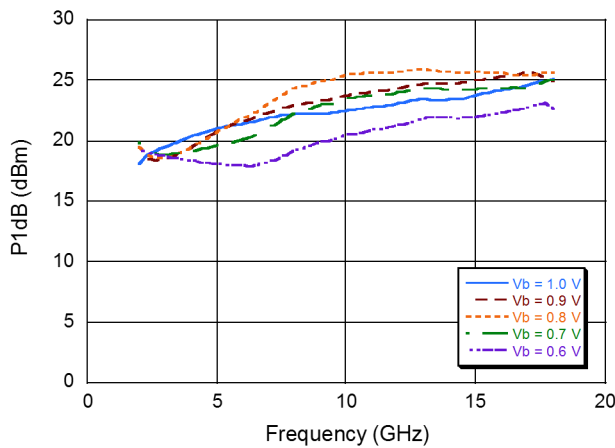

Output IP3 @ $T_A = -40^\circ\text{C}$, $V_{DD} = 3.3\text{ V}$

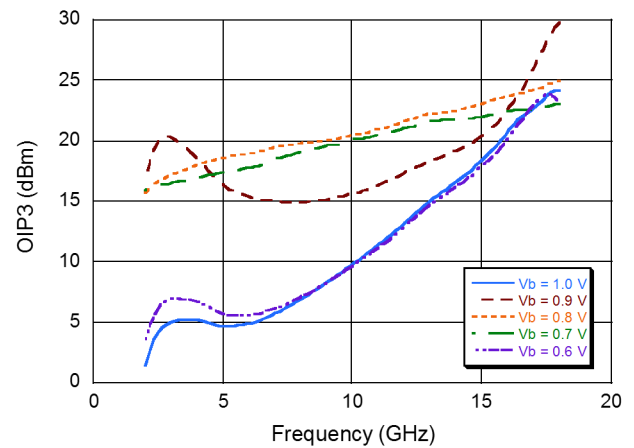

Output IP3 @ $T_A = 85^\circ\text{C}$, $V_{DD} = 5\text{ V}$

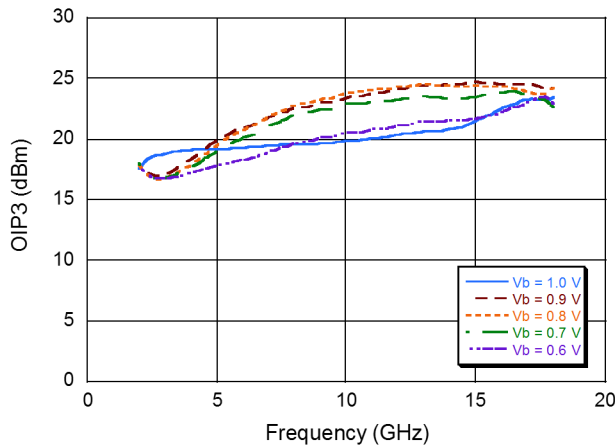

Output IP3 @ $T_A = 85^\circ\text{C}$, $V_{DD} = 3.3\text{ V}$

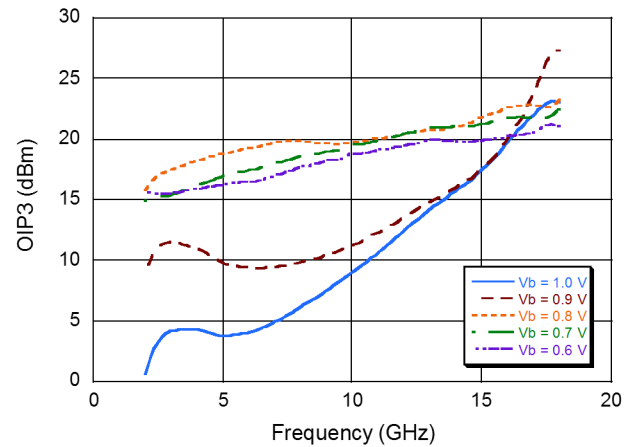

Broadband Low Noise Amplifier 2 - 18 GHz

Rev. V1

Typical P1dB and P3dB Curves $V_{DD} = 5 V$

P1dB @ $V_{DD} = 5 V, V_B = 0.9 V$

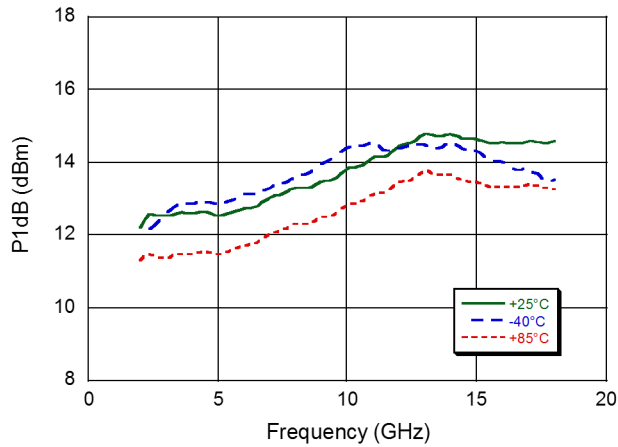

P3dB @ $V_{DD} = 5 V, V_B = 0.9 V$

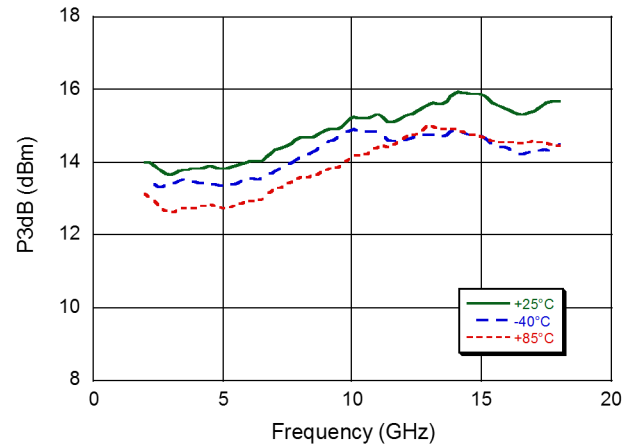

P1dB @ $T_A = 25^\circ C, V_{DD} = 5 V$

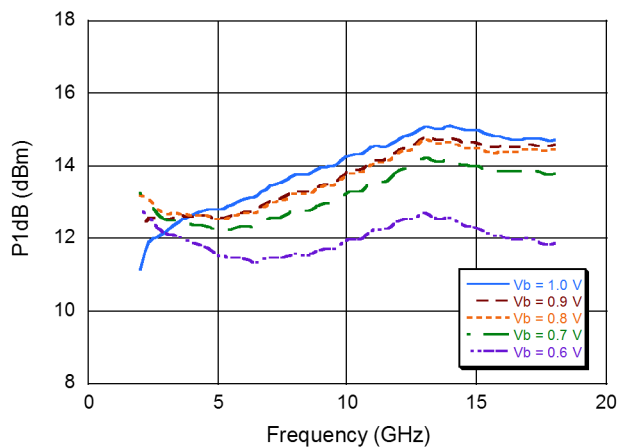

P3dB @ $T_A = 25^\circ C, V_{DD} = 5 V$

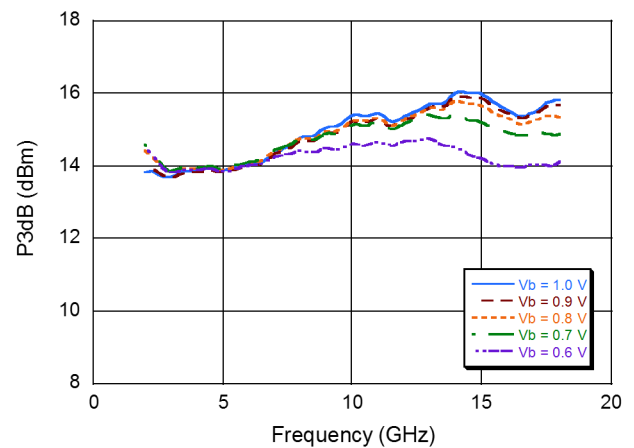

Broadband Low Noise Amplifier 2 - 18 GHz

Rev. V1

Typical P1dB and P3dB Curves $V_{DD} = 3.3\text{ V}$

P1dB @ $V_{DD} = 3.3\text{ V}$, $V_B = 0.8\text{ V}$

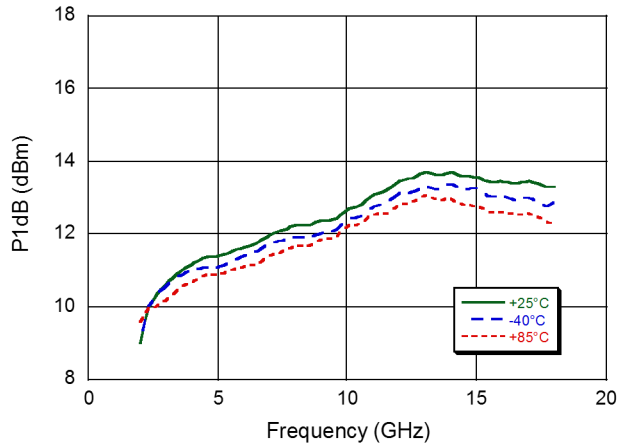

P3dB @ $V_{DD} = 3.3\text{ V}$, $V_B = 0.8\text{ V}$

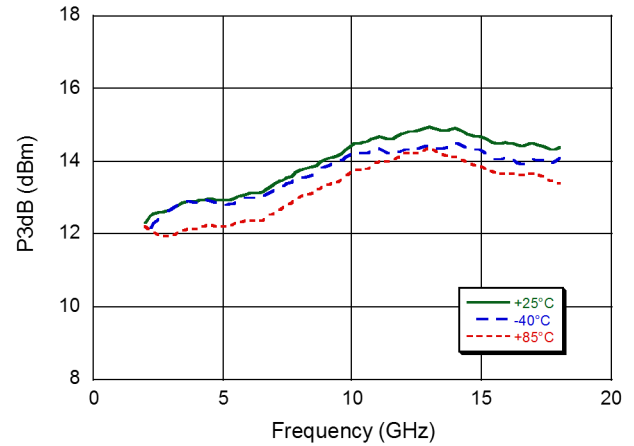

P1dB @ $T_A = 25^\circ\text{C}$, $V_{DD} = 3.3\text{ V}$

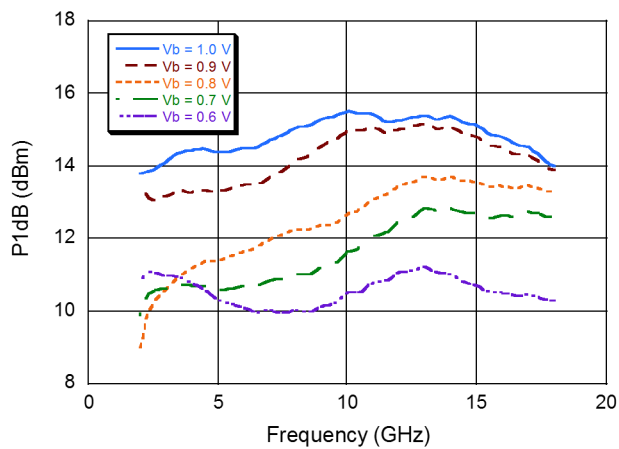

P3dB @ $T_A = 25^\circ\text{C}$, $V_{DD} = 3.3\text{ V}$

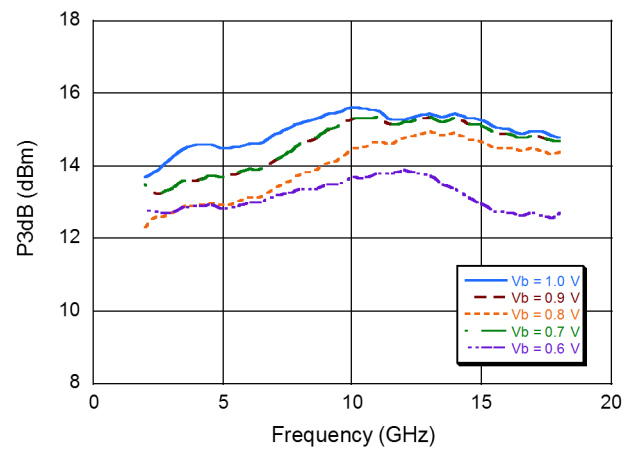

Broadband Low Noise Amplifier 2 - 18 GHz

Rev. V1

Lead-Free 2 mm 8-Lead PDFN[†]

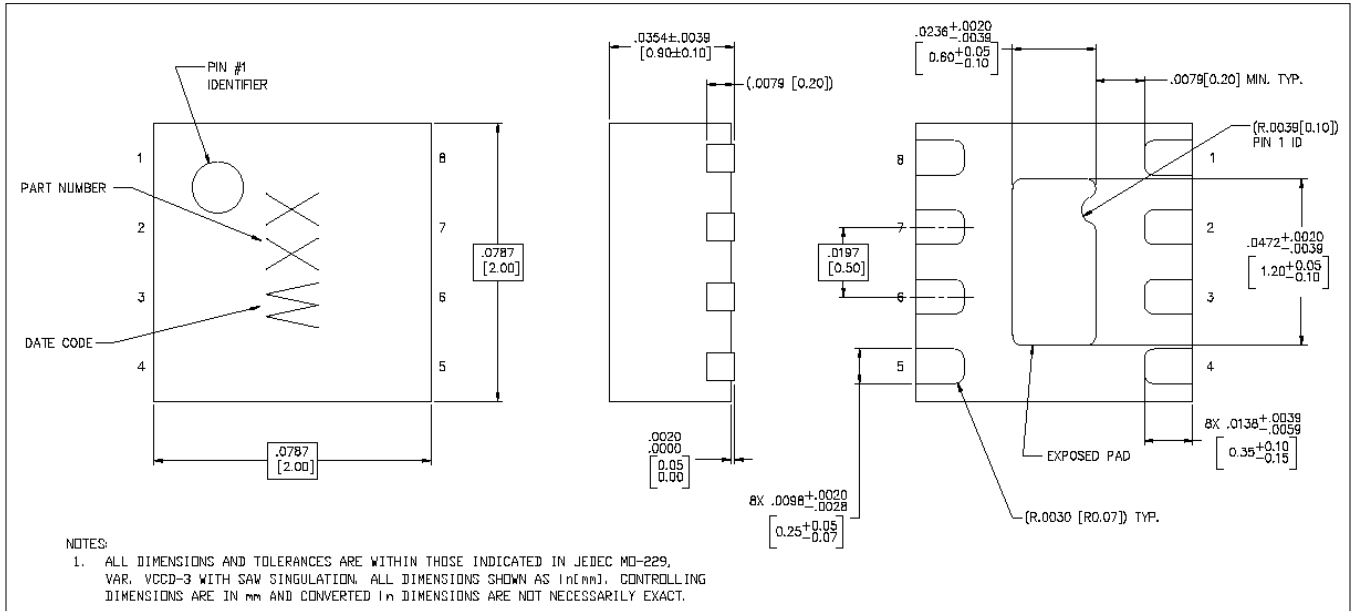

[†] Reference Application Note S2083 for lead-free solder reflow recommendations.
Meets JEDEC moisture sensitivity level 1 requirements.
Plating is 100% matte tin over copper.

MACOM Technology Solutions Inc. All rights reserved.

Information in this document is provided in connection with MACOM Technology Solutions Inc ("MACOM") products. These materials are provided by MACOM as a service to its customers and may be used for informational purposes only. Except as provided in MACOM's Terms and Conditions of Sale for such products or in any separate agreement related to this document, MACOM assumes no liability whatsoever. MACOM assumes no responsibility for errors or omissions in these materials. MACOM may make changes to specifications and product descriptions at any time, without notice. MACOM makes no commitment to update the information and shall have no responsibility whatsoever for conflicts or incompatibilities arising from future changes to its specifications and product descriptions. No license, express or implied, by estoppel or otherwise, to any intellectual property rights is granted by this document.

THESE MATERIALS ARE PROVIDED "AS IS" WITHOUT WARRANTY OF ANY KIND, EITHER EXPRESS OR IMPLIED, RELATING TO SALE AND/OR USE OF MACOM PRODUCTS INCLUDING LIABILITY OR WARRANTIES RELATING TO FITNESS FOR A PARTICULAR PURPOSE, CONSEQUENTIAL OR INCIDENTAL DAMAGES, MERCHANTABILITY, OR INFRINGEMENT OF ANY PATENT, COPYRIGHT OR OTHER INTELLECTUAL PROPERTY RIGHT. MACOM FURTHER DOES NOT WARRANT THE ACCURACY OR COMPLETENESS OF THE INFORMATION, TEXT, GRAPHICS OR OTHER ITEMS CONTAINED WITHIN THESE MATERIALS. MACOM SHALL NOT BE LIABLE FOR ANY SPECIAL, INDIRECT, INCIDENTAL, OR CONSEQUENTIAL DAMAGES, INCLUDING WITHOUT LIMITATION, LOST REVENUES OR LOST PROFITS, WHICH MAY RESULT FROM THE USE OF THESE MATERIALS.

MACOM products are not intended for use in medical, lifesaving or life sustaining applications. MACOM customers using or selling MACOM products for use in such applications do so at their own risk and agree to fully indemnify MACOM for any damages resulting from such improper use or sale.