



Chipsmall Limited consists of a professional team with an average of over 10 year of expertise in the distribution of electronic components. Based in Hongkong, we have already established firm and mutual-benefit business relationships with customers from,Europe,America and south Asia,supplying obsolete and hard-to-find components to meet their specific needs.

With the principle of “Quality Parts,Customers Priority,Honest Operation,and Considerate Service”,our business mainly focus on the distribution of electronic components. Line cards we deal with include Microchip,ALPS,ROHM,Xilinx,Pulse,ON,Everlight and Freescale. Main products comprise IC,Modules,Potentiometer,IC Socket,Relay,Connector.Our parts cover such applications as commercial,industrial, and automotives areas.

We are looking forward to setting up business relationship with you and hope to provide you with the best service and solution. Let us make a better world for our industry!



Contact us

Tel: +86-755-8981 8866 Fax: +86-755-8427 6832

Email & Skype: info@chipsmall.com Web: www.chipsmall.com

Address: A1208, Overseas Decoration Building, #122 Zhenhua RD., Futian, Shenzhen, China



Features

- Single stage, single ended, 8 V, 130 mA
- 18 dB Flat Gain
- Low Noise
- Low Distortion Performance
- Lead-Free 2 mm 8-lead PDFN Plastic Package
- Halogen-Free “Green” Mold Compound
- RoHS* Compliant

Description

The MAAM-011182 is an RF amplifier assembled in a 2 mm 8-lead PDFN plastic package. This amplifier provides 18 dB of ultra flat gain while biased at 8 volts. The amplifier provides excellent linearity.

The MAAM-011182 provides high gain, low noise and low distortion making it ideally suited for 75 Ω infrastructure applications.

The MAAM-011182 is fabricated using GaAs pHEMT technology.

Ordering Information^{1,2}

Part Number	Package
MAAM-011182	Bulk Packaging
MAAM-011182-TR1000	1000 Part Reel
MAAM-011182-TR3000	3000 Part Reel
MAAM-011182-001SMB	Sample Board

1. Reference Application Note M513 for reel size information.
2. All sample boards include 5 loose parts.

Functional Schematic

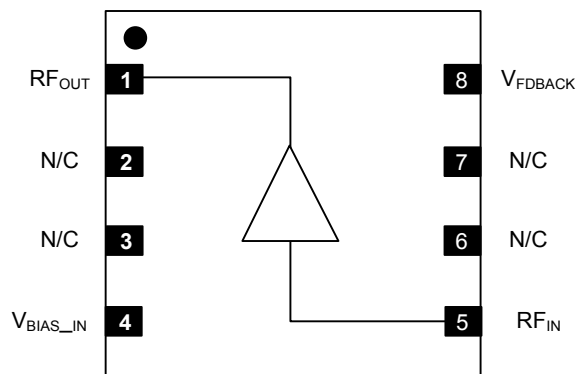

Pin Configuration³

Pin No.	Pin Name	Function
1	RF _{OUT}	RF Output (75 Ω)
2	N/C	No Connection
3	N/C	No Connection
4	V _{BIAS_IN}	Regulator Bias Input
5	RF _{IN}	RF Input (75 Ω)
6	N/C	No Connection
7	N/C	No Connection
8	V _{FDBACK}	Feedback Path
9	Pad ³	RF and DC Ground

3. The exposed pad centered on the package bottom must be connected to RF and DC ground.

* Restrictions on Hazardous Substances, European Union Directive 2011/65/EU.

Electrical Specifications: Freq. = 50 - 1218 MHz, $T_A = 25^\circ\text{C}$, $V_{DD} = 8\text{ V}$, $Z_0 = 75\ \Omega$

Parameter	Test Conditions	Units	Min.	Typ.	Max.
Gain	1218 MHz	dB	18	18.5	19
Tilt	50 - 1218 MHz	dB	0	0.3	1
Reverse Isolation	—	dB	—	21.5	—
Input Return Loss	—	dB	—	20	—
Output Return Loss	—	dB	—	19	—
Noise Figure	50 - 100 MHz 100 - 1218 MHz	dB	— —	2.7 2.5	3.8 3.0
Output IP2	50 - 1200 MHz, tone spacing 6 MHz, P_{OUT} per tone = -10 dBm	dBm	—	66	—
Output IP3	50 - 1200 MHz, tone spacing 6 MHz, P_{OUT} per tone = -10 dBm	dBm	—	38	—
P1dB	—	dBm	—	24	—
Composite Triple Beat, CTB	79 channels, 0 dB Tilt, 34 dBmV per channel output QAM to 1200 MHz	dBc	—	76	-74
Composite Second Order, CSO	79 channels, 0 dB Tilt, 34 dBmV per channel output QAM to 1200 MHz	dBc	—	68	-66
I_{DD}	$V_{DD} = 8\text{ V}$	mA	125	130	135

Absolute Maximum Ratings^{4,5,6,7}

Parameter	Absolute Maximum
Max Input Power	12 dBm
Operating Voltage	10 volts
Operating Temperature	-40°C to +85°C
Storage Temperature	-65°C to +150°C

4. Exceeding any one or combination of these limits may cause permanent damage to this device.
5. MACOM does not recommend sustained operation near these survivability limits.
6. These operating conditions will ensure MTTF > 1 x 10⁶ hours.
7. Junction Temperature (T_J) = Case Temperature (T_C) + $\Theta_{jc} \cdot (V \cdot I)$
 Typical thermal resistance (Θ_{jc}) = 43.3°C/W.
 - a) For $T_C = 25^\circ\text{C}$,
 $T_J = 71.7^\circ\text{C} @ 8\text{ V}, 135\text{ mA}$
 - b) For $T_C = 85^\circ\text{C}$,
 $T_J = 131.7^\circ\text{C} @ 8\text{ V}, 135\text{ mA}$

Handling Procedures

Please observe the following precautions to avoid damage:

Static Sensitivity

Gallium Arsenide Integrated Circuits are sensitive to electrostatic discharge (ESD) and can be damaged by static electricity. Proper ESD control techniques should be used when handling these HBM Class1A, CDM Class IV devices.

Schematic Including Off-Chip Components

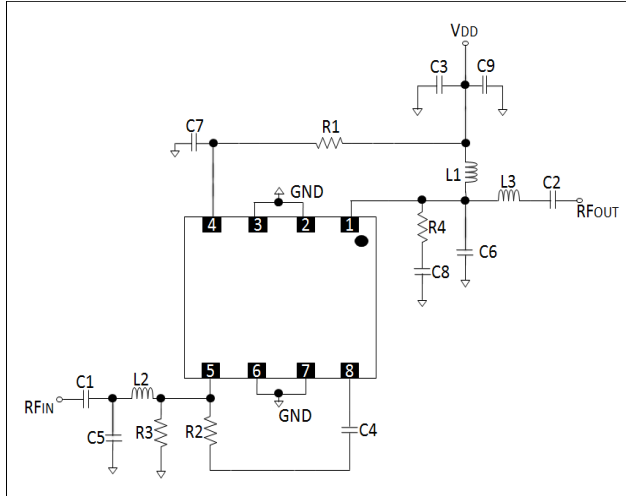

Parts List⁸

Component	Value	Package
C1,C4,C7	10 nF	0402
C2	150 pF	0402
C3	100 nF	0402
C5	0.9 pF	0402
C6	0.4 pF	0402
C8	0.6 pF	0402
C9	1 μ F	0603
L1	Ferrite Bead	0402
L2	10 nH	0402
L3	5.6 nH	0402
R1	1.6 k Ω	0402
R2	360 Ω	0402
R3	910 Ω	0402
R4	300 Ω	0402

8. Ferrite Bead from Murata, part number BLM15HD182SN.

Recommended PCB Layout

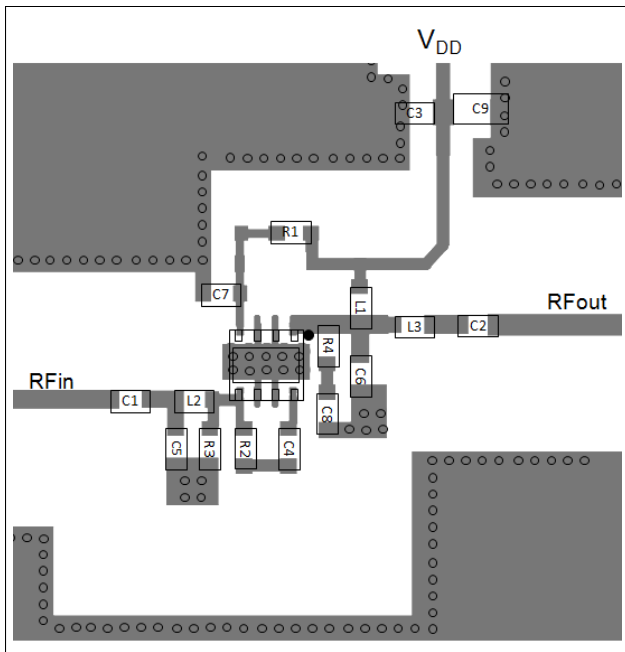

PCB Land Pattern

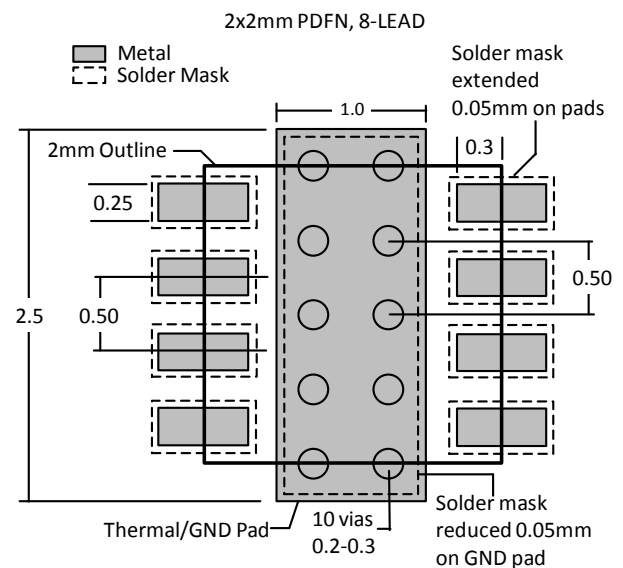

Typical Performance Curves: $V_{DD} = 8 V$

Gain to 1.218 GHz

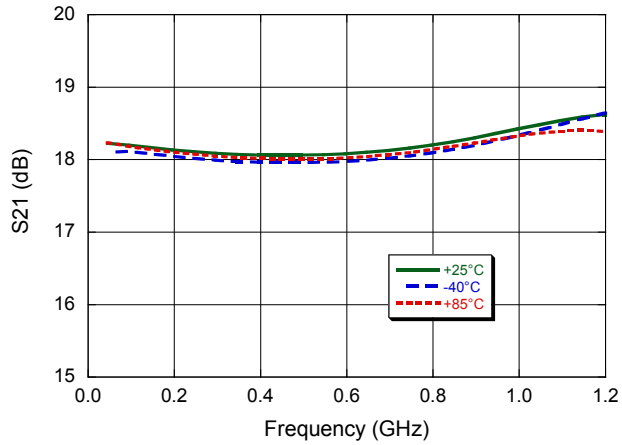

Gain to 2.5 GHz

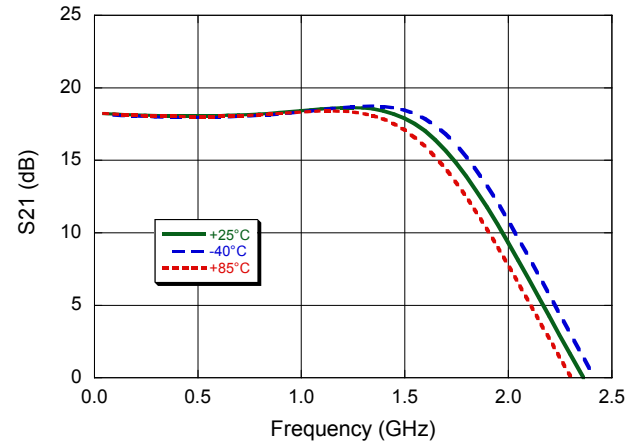

Input Return Loss

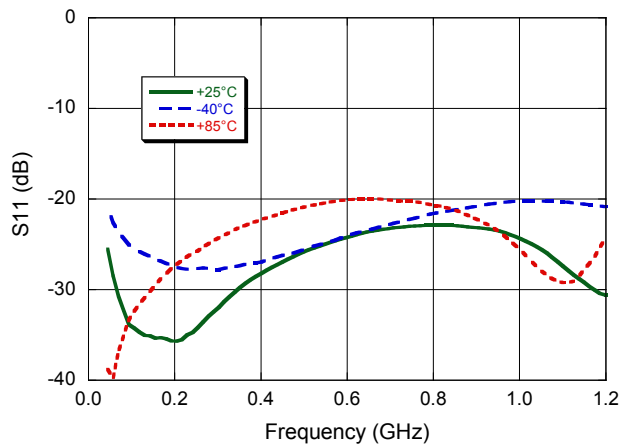

Output Return Loss

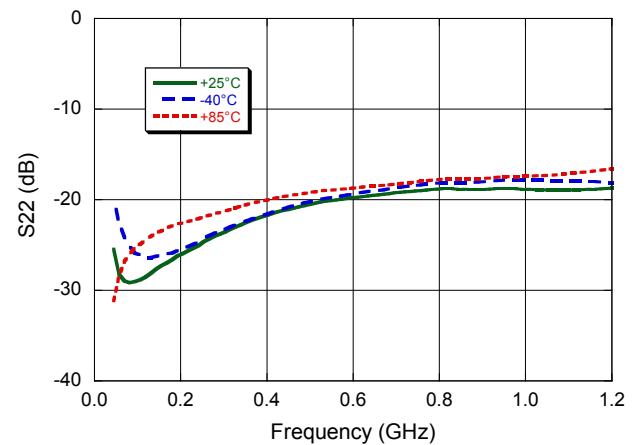

Reverse Isolation

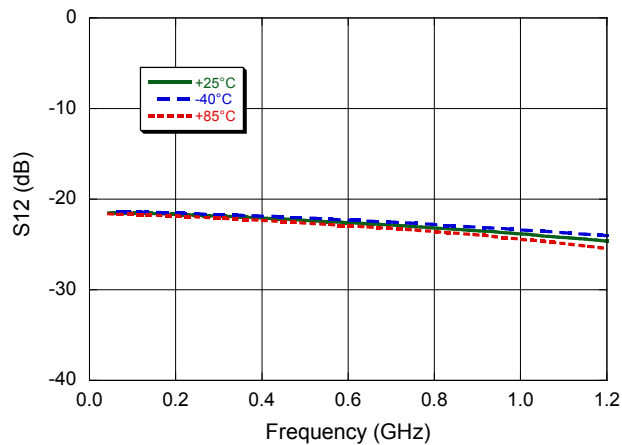

Noise Figure

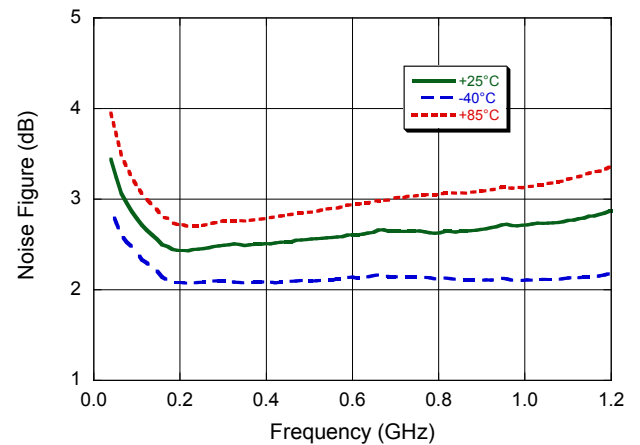

Typical Performance Curves: $V_{DD} = 8 V$

CSO Lower
 79 ch , 0 dB tilt, 34 dBmV per ch

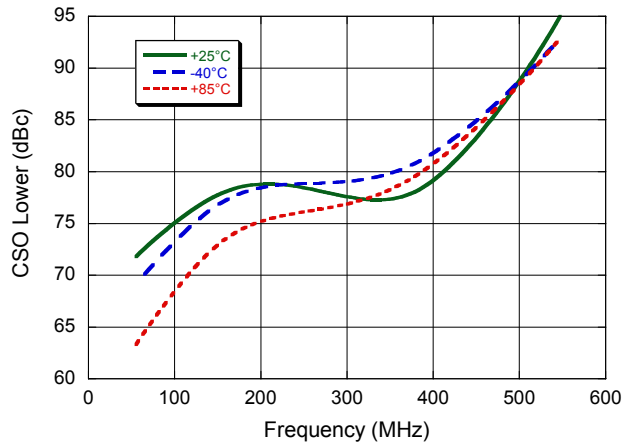

CSO Upper
 79 ch , 0 dB tilt, 34 dBmV per ch

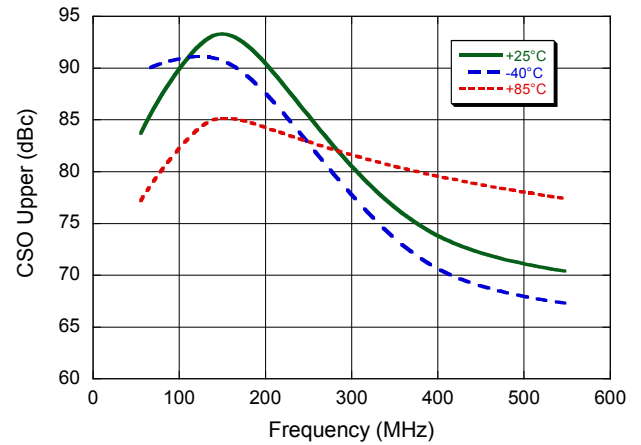

CTB
 79 ch , 0 dB tilt, 34 dBmV per ch

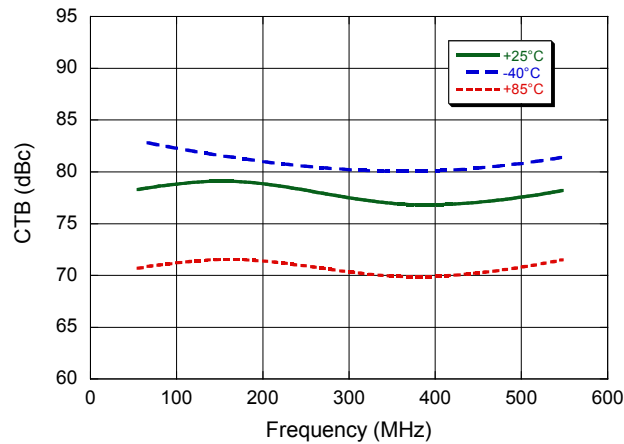

Lead Free 2 mm 8-lead PDFN†

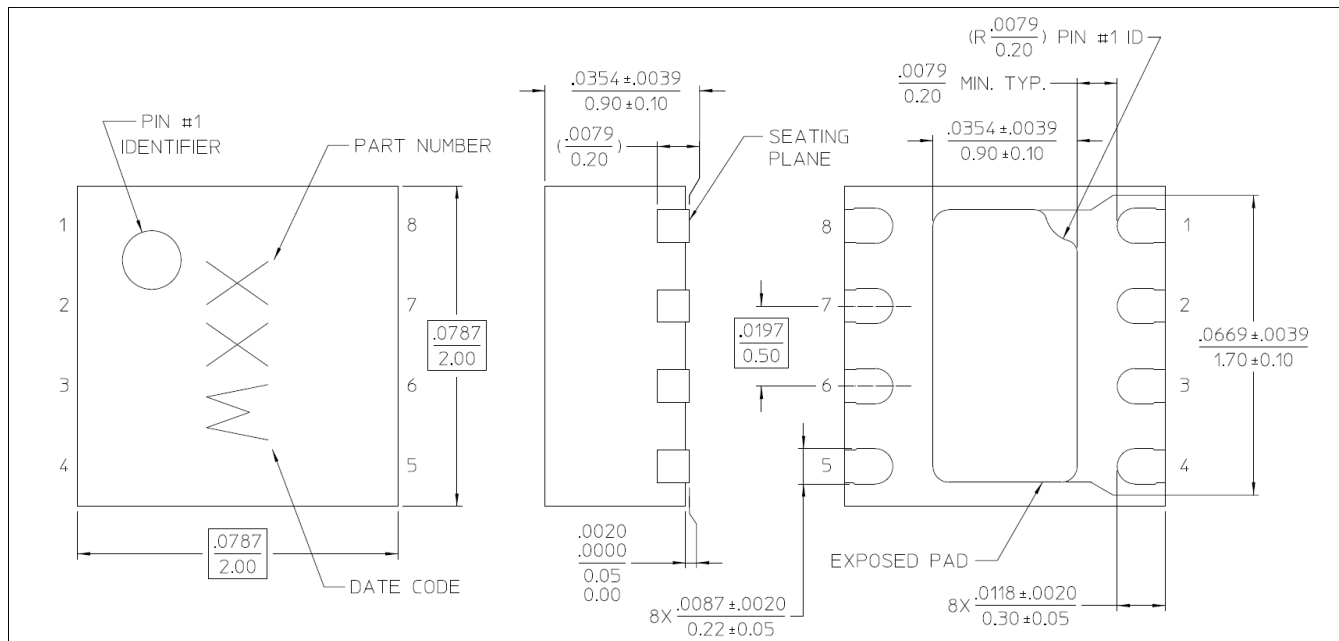

† Reference Application Note S2083 for lead-free solder reflow recommendations.
 Meets JEDEC moisture sensitivity level 1 requirements.
 Plating is 100% matte tin over copper.

M/A-COM Technology Solutions Inc. All rights reserved.

Information in this document is provided in connection with M/A-COM Technology Solutions Inc ("MACOM") products. These materials are provided by MACOM as a service to its customers and may be used for informational purposes only. Except as provided in MACOM's Terms and Conditions of Sale for such products or in any separate agreement related to this document, MACOM assumes no liability whatsoever. MACOM assumes no responsibility for errors or omissions in these materials. MACOM may make changes to specifications and product descriptions at any time, without notice. MACOM makes no commitment to update the information and shall have no responsibility whatsoever for conflicts or incompatibilities arising from future changes to its specifications and product descriptions. No license, express or implied, by estoppel or otherwise, to any intellectual property rights is granted by this document.

THESE MATERIALS ARE PROVIDED "AS IS" WITHOUT WARRANTY OF ANY KIND, EITHER EXPRESS OR IMPLIED, RELATING TO SALE AND/OR USE OF MACOM PRODUCTS INCLUDING LIABILITY OR WARRANTIES RELATING TO FITNESS FOR A PARTICULAR PURPOSE, CONSEQUENTIAL OR INCIDENTAL DAMAGES, MERCHANTABILITY, OR INFRINGEMENT OF ANY PATENT, COPYRIGHT OR OTHER INTELLECTUAL PROPERTY RIGHT. MACOM FURTHER DOES NOT WARRANT THE ACCURACY OR COMPLETENESS OF THE INFORMATION, TEXT, GRAPHICS OR OTHER ITEMS CONTAINED WITHIN THESE MATERIALS. MACOM SHALL NOT BE LIABLE FOR ANY SPECIAL, INDIRECT, INCIDENTAL, OR CONSEQUENTIAL DAMAGES, INCLUDING WITHOUT LIMITATION, LOST REVENUES OR LOST PROFITS, WHICH MAY RESULT FROM THE USE OF THESE MATERIALS.

MACOM products are not intended for use in medical, lifesaving or life sustaining applications. MACOM customers using or selling MACOM products for use in such applications do so at their own risk and agree to fully indemnify MACOM for any damages resulting from such improper use or sale.